

**Accessories**

**Accessori**

**Accesorios**

**3.0**

Opening scheme  
Surface finishes

Schema di apertura  
Finiture

Diagrama de apertura  
Acabados de superficie

Gaskets  
System accessories  
Hinges  
Flush bolts  
General fittings  
Locks  
Screws  
Assembling tools  
Multipoint steel rods,  
with Graz  
Multipoint aluminum rods,  
with Graz and Mono  
Multipoint aluminum rods,  
with lever handle  
Tilt&Turn window

Guarnizioni  
Accessori di sistema  
Cerniere  
Catenacci  
Ferramenta generale  
Serrature  
Viti  
Utensili di assemblaggio  
Multipoint aste in acciaio,  
con Graz  
Multipoint aste in alluminio,  
con Graz e Mono  
Multipoint aste in alluminio,  
con cariglione  
Finestra anta ribalta

Juntas de sellado  
Accesorios del sistema  
Bisagras  
Pasador de canto  
Herrajes generales  
Cerraduras  
Tornillos  
Herramientas de montaje  
Multipoint varillas de acero,  
con Graz  
Multipoint varillas de aluminio,  
con Graz y Mono  
Multipoint varillas de aluminio,  
con manija de bloqueo  
Ventana oscilante

**3.1**  
**3.2**  
**3.3**  
**3.4**  
**3.5**  
**3.6**  
**3.7**  
**3.8**  
**3.9**  
**3.10**  
**3.11**  
**3.12**

### Opening scheme

A window or a door is defined as "left opening" or "right opening" when, viewed from the opening side, the hinges are respectively on the left or on the right.

### Schema di apertura

Una finestra o una porta si definiscono "apertura sinistra" o "apertura destra" quando, vista dalla parte del verso di apertura, le cerniere si trovano rispettivamente a sinistra o a destra.

### Diagrama de apertura

Una ventana o puerta se llama "apertura izquierda" o "apertura derecha" cuando, en la dirección de apertura, las bisagras están respectivamente a la izquierda o a la derecha.

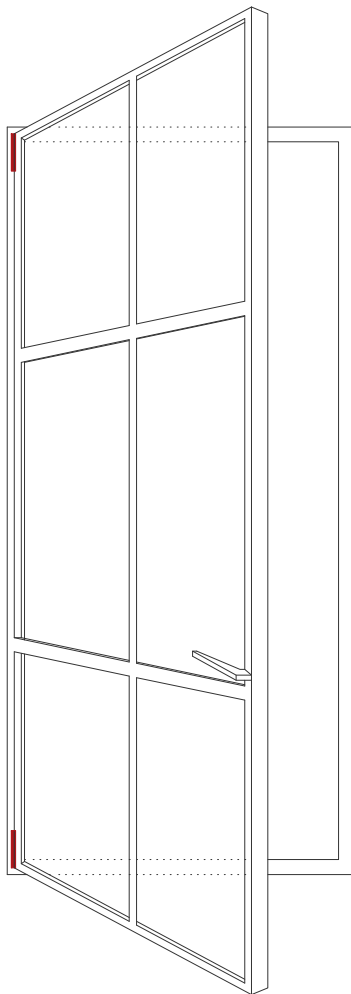

Left opening

Apertura sinistra

Apertura izquierda

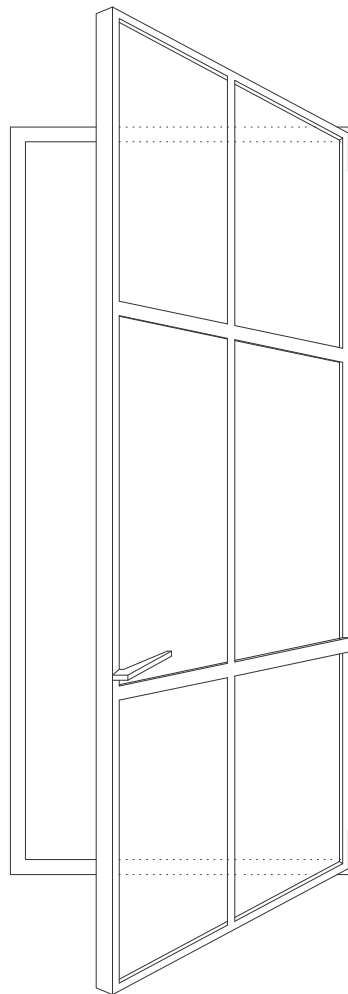

Right opening







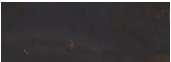
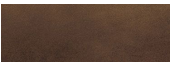

Apertura destra

Apertura derecha

**Surface finishes**

**Finiture superfici**

**Acabados de superficie**

Satin chrome	Cromo satinato	Cromo mate cepillado	SC 15	
Dark bronze	Bronzo anticato	Bronce oscuro	DB 17	
Oil-rubbed bronze	Bronzo brunito cerato	Bronce engrasado	OB 18	
Satin brass	Ottone satinato	Latón satinado	SB 20	
Polished brass	Ottone lucidato	Latón pulido	PB 23	
Antique nickel	Nichel anticato	Níquel antiguo	AN 24	
Satin stainless steel	Acciaio inossidabile satinato	Acero inoxidable satinado	SS 26	
Polished nickel	Nichel lucidato	Niquelado pulido	PN 28	
Satin nickel	Nichel satinato	Niquelado satinado	SN 29	
Gun metal	Grigio canna di fucile	Gris oscuro	GM 42	
Matt black	Nero opaco	Negro mate	MB 43	



**Gaskets**

**Guarnizioni**

**Juntas de sellado**

**3.1**

**Internal/External  
rebate gasket**

-60 = EPDM black  
-77 = EPDM white

PU = 50 m

**Guarnizione di battuta  
interna/esterna**

-60 = EPDM nero  
-77 = EPDM bianco

UV = 50 m

**Junta de tope  
interior/exterior**

-60 = EPDM negro  
-77 = EPDM blanco

CANTIDAD = 50 m



G99021-nn

**Internal/External  
rebate gasket**

-60 = EPDM black  
-77 = EPDM white

PU = 50 m

**Guarnizione di battuta  
interna/esterna**

-60 = EPDM nero  
-77 = EPDM bianco

UV = 50 m

**Junta de tope  
interior/exterior**

-60 = EPDM negro  
-77 = EPDM blanco

CANTIDAD = 50 m



G99022-nn

**Internal/External  
rebate gasket**

-60 = EPDM black  
-77 = EPDM white

PU = 50 m

**Guarnizione di battuta  
interna/esterna**

-60 = EPDM nero  
-77 = EPDM bianco

UV = 50 m

**Junta de tope  
interior/exterior**

-60 = EPDM negro  
-77 = EPDM blanco

CANTIDAD = 50 m



G99023-nn

**External glazing gasket**

EPDM, black, self-adhesive, 3 mm

PU = 50 m

**Guarnizione vetro esterna**

EPDM, nero, autoadesivo, 3 mm

UV = 50 m

**Junta de acristalamiento exterior**

EPDM, color negro, autoadhesiva, 3 mm

CANTIDAD = 50 m

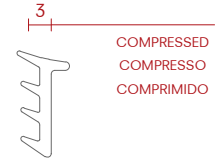

G99107-60

**External glazing gasket**

EPDM, black, self-adhesive, 5 mm

PU = 100 m

**Guarnizione vetro esterna**

EPDM, nero, autoadesivo, 5 mm

UV = 100 m

**Junta de acristalamiento exterior**

EPDM, color negro, autoadhesiva, 5 mm

CANTIDAD = 100 m

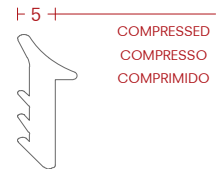

G99108-60

**External tape seals**

Neoprene, black, self-adhesive, 3 mm

PU = 20 m

**Nastro autoadesivo esterno**

Neoprene, nero, autoadesivo, 3 mm

UV = 20 m

**Cinta exterior**

Neopreno, color negro, autoadhesiva, 3 mm

CANTIDAD = 20 m



G99102-61

**External tape seals**

PVC, black, self-adhesive, 5 mm

PU = 15 m

**Nastro autoadesivo esterno**

PVC, nero, autoadesivo, 5 mm

UV = 15 m

**Cinta exterior**

PVC, color negro, autoadhesiva, 5 mm

CANTIDAD = 15 m



G99103-62

**Internal tape seals**

Neoprene, black,  
self-adhesive, 3 mm

PU = 20 m

**Nastro autoadesivo interno Cinta interior**

Neoprene, nero,  
autoadesivo, 3 mm

UV = 20 m

Neopreno, color negro,  
autoadhesiva, 3 mm

CANTIDAD = 20 m

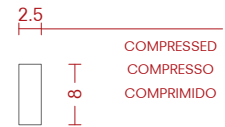

G99201-61

**Internal tape seals**

Neoprene, black,  
self-adhesive, 4 mm

PU = 20 m

**Nastro autoadesivo interno Cinta interior**

Neoprene, nero,  
autoadesivo, 4 mm

UV = 20 m

Neopreno, color negro,  
autoadhesiva, 4 mm

CANTIDAD = 20 m

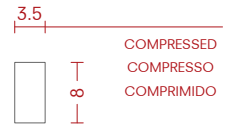

G99202-61

**Internal tape seals**

Neoprene, black,  
self-adhesive, 5 mm

PU = 20 m

**Nastro autoadesivo interno Cinta interior**

Neoprene, nero,  
autoadesivo, 5 mm

UV = 20 m

Neopreno, color negro,  
autoadhesiva, 5 mm

CANTIDAD = 20 m

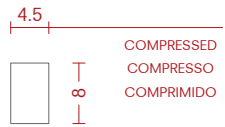

G99203-61

**Internal tape seals**

Neoprene, black,  
self-adhesive, 6 mm

PU = 20 m

**Nastro autoadesivo interno Cinta interior**

Neoprene, nero,  
autoadesivo, 6 mm

UV = 20 m

Neopreno, color negro,  
autoadhesiva, 6 mm

CANTIDAD = 20 m

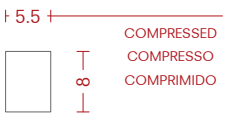

G99204-61



**Internal glazing gasket**

EPDM, black, 3 mm,  
light blue printed line.

PU = 50 m

**Guarnizione vetro interna**

EPDM, nero, 3 mm,  
linea azzurra stampata.

UV = 50 m

**Junta de acristalamiento interior**

EPDM, color negro, 3 mm,  
línea azul claro impresa.

CANTIDAD = 50 m

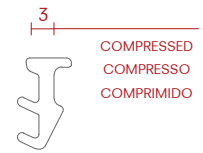

G99215-60

**Internal glazing gasket**

EPDM, black, 4 mm,  
red printed line.

PU = 50 m

**Guarnizione vetro interna**

EPDM, nero, 4 mm,  
linea rossa stampata.

UV = 50 m

**Junta de acristalamiento interior**

EPDM, color negro, 4 mm,  
línea roja impresa.

CANTIDAD = 50 m

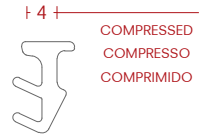

G99216-60

**Internal glazing gasket**

EPDM, black, 5 mm,  
green printed line.

PU = 50 m

**Guarnizione vetro interna**

EPDM, nero, 5 mm,  
linea verde stampata.

UV = 50 m

**Junta de acristalamiento interior**

EPDM, color negro, 5 mm,  
línea verde impresa.

CANTIDAD = 50 m

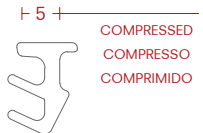

G99217-60

**Internal glazing gasket**

EPDM, black, 6 mm,  
yellow printed line.

PU = 50 m

**Guarnizione vetro interna**

EPDM, nero, 6 mm,  
linea gialla stampata.

UV = 50 m

**Junta de acristalamiento interior**

EPDM, color negro, 6 mm,  
línea amarilla impresa.

CANTIDAD = 50 m

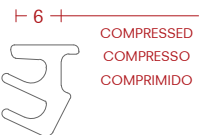

G99218-60



**System accessories**

**Accessori di sistema**

**Accesorios del sistema**

**3.2**

**Weather bar**

Aluminium.  
Installation only on galvanized steel (-02) and bright steel (-12) profiles.

L = 5800 mm

**Gocciolatoio**

Alluminio.  
Montaggio solo su profili in acciaio zincato (-02) e acciaio decapato (-12).

L = 5800 mm

**Vierteaguas**

Aluminio.  
Montaje solo para perfiles en acero galvanizado (-02) y en acero bruto (-12).

L = 5800 mm

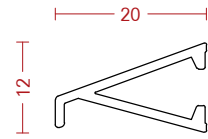

A99001-00

**Fixing screw**

Fixing screw weather bar  
A99001-00, M4x9 mm DIN84

PU = 50 pieces

**Vite di fissaggio**

Vite di fissaggio gocciolatoio  
A99001-00, M4x9 mm DIN84

UV = 50 pezzi

**Cabezal de fijación**

Tornillo de fijación vierteaguas  
A99001-00, M4x9 mm DIN84

CANTIDAD = 50 unidades



D99901-02

**Weather bar**

-02 = Galvanized steel  
-06 = Stainless steel AISI 316L  
-07 = Cor-Ten steel

L = 3000 mm

**Gocciolatoio**

-02 = Acciaio zincato  
-06 = Acciaio inox AISI 316L  
-07 = Acciaio Cor-Ten

L = 3000 mm

**Vierteaguas**

-02 = Acero galvanizado  
-06 = Acero inoxidable AISI 316L  
-07 = Acero Cor-Ten

L = 3000 mm

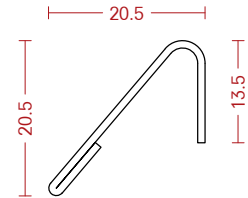

A99008-nn

**End pieces**

For open in and open out double  
leaf window, 2nd leaf.

B = black  
W = white

PU = 1 set

**Terminali**

Per finestra doppia anta, apertura  
interna ed esterna, 2a anta.

B = nero  
W = bianco

UV = 1 set

**Pieza final**

Ventana de dos hojas que se  
abre hacia dentro y fuera,  
2do hoja.

B = negro  
W = blanco

CANTIDAD = 1 conjunto

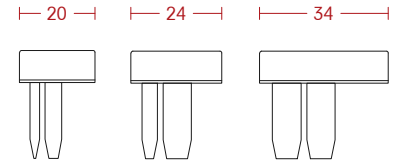

K99022 B  
K99025 W

**Drainage gasket**

Water drainage gasket.  
EPDM, black

Compatible only with profiles  
FT 7512LR-nn, FT 7512TR-nn,  
FT 7512ZR-nn and FT 7512HR-nn

L = 50 m

**Guarnizione di drenaggio**

Guarnizione di drenaggio acqua.  
EPDM, nero

Compatibile solo con i profili  
FT 7512LR-nn, FT 7512TR-nn,  
FT 7512ZR-nn e FT 7512HR-nn

L = 50 m

**Junta de drenaje**

Junta de drenaje de agua.  
EPDM, color negro

Compatible solo con perfiles  
FT 7512LR-nn, FT 7512TR-nn,  
FT 7512ZR-nn y FT 7512HR-nn

L = 50 m



G99312-60

**Drainage gasket**

Water drainage gasket.  
EPDM, black

NOT compatible with profiles  
FT 7512LR-nn, FT 7512TR-nn,  
FT 7512ZR-nn and FT 7512HR-nn

L = 50 m

**Guarnizione di drenaggio**

Guarnizione di drenaggio acqua.  
EPDM, nero

NON compatibile con i profili  
FT 7512LR-nn, FT 7512TR-nn,  
FT 7512ZR-nn e FT 7512HR-nn

L = 50 m

**Junta de drenaje**

Junta de drenaje de agua.  
EPDM, color negro

NO es compatible con perfiles  
FT 7512LR-nn, FT 7512TR-nn,  
FT 7512ZR-nn y FT 7512HR-nn

L = 50 m



G99313-60

**Cover cap**

Plastic, black, for drainage holes.

PU = 10 pieces

**Tappo scarico acqua**

Plastica, nero, per chiusura  
fori drenaggio.

UV = 10 pezzi

**Tapa**

Plastico, negro, para  
orificios de drenaje.

CANTIDAD = 10 unidades

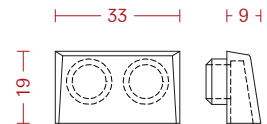

A99201-35

**Cover cap**

Stainless steel  
for drainage holes.

PU = 4 pieces

**Tappo scarico acqua**

Acciaio inox, per chiusura  
fori drenaggio.

UV = 4 pezzi

**Tapa**

Acero inoxidable para  
orificios de drenaje.

CANTIDAD = 4 unidades

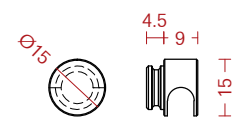

K99071



**Hinges**

**Cerniere**

**Bisagras**

**3.3**

**Weld-on hinge**

Bright steel, Ø10 mm, length 60 mm, with fixed pin and brass intermediate washer.

Capacity: 38 kg (pair=2 pc)

PU = 1 piece

**Cerniera a saldare**

Acciaio decapato, Ø10 mm, lunghezza 60 mm, con perno fisso e rondella intermedia in ottone.

Portata: 38 kg (coppia=2 pezzi)

UV = 1 pezzo

**Bisagra de soldadura**

Acero bruto, diámetro de Ø10 mm, longitud de 60 mm, con perno fijo y anillo intermedio de latón.

Capacidad de carga: 38 kg (par=2 unidades)

CANTIDAD = 1 unidad

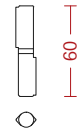

C99000-12

**Weld-on hinge**

Bright steel, Ø12 mm, length 80 mm, with fixed pin and brass intermediate washer.

Capacity: 50 kg (pair=2 pc)

-03 = Stainless steel  
-12 = Bright steel

PU = 1 piece

**Cerniera a saldare**

Acciaio decapato, Ø12 mm, lunghezza 80 mm, con perno fisso e rondella intermedia in ottone.

Portata: 50 kg (coppia=2 pezzi)

-03 = Acciaio inossidabile  
-12 = Acciaio decapato

UV = 1 pezzo

**Bisagra de soldadura**

Acero bruto, diámetro de Ø12 mm, longitud de 80 mm, con perno fijo y anillo intermedio de latón.

Capacidad de carga: 50 kg (par=2 unidades)

-03 = Acero inoxidable  
-12 = Acero bruto

CANTIDAD = 1 unidad

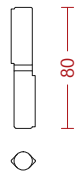

C99001-nn

**Weld-on hinge**

Bright steel, Ø14 mm, length 100 mm, with fixed pin and brass intermediate washer.

Capacity: 80 kg (pair=2 pc)

PU = 1 piece

**Cerniera a saldare**

Acciaio decapato, Ø14 mm, lunghezza 100 mm, con perno fisso e rondella intermedia in ottone.

Portata: 80 kg (coppia=2 pezzi)

UV = 1 pezzo

**Bisagra de soldadura**

Acero bruto, diámetro de Ø14 mm, longitud de 100 mm, con perno fijo y anillo intermedio de latón.

Capacidad de carga: 80 kg (par=2 unidades)

CANTIDAD = 1 unidad

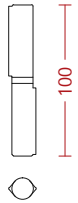

C99002-12

**Weld-on hinge**

Bright steel, Ø16 mm, length 120 mm, with fixed pin and brass intermediate washer.

Capacity: 100 kg (pair=2 pc)

PU = 1 piece

**Cerniera a saldare**

Acciaio decapato, Ø16 mm, lunghezza 120 mm, con perno fisso e rondella intermedia in ottone.

Portata: 100 kg (coppia=2 pezzi)

UV = 1 pezzo

**Bisagra de soldadura**

Acero bruto, diámetro de Ø16 mm, longitud de 120 mm, con perno fijo y anillo intermedio de latón.

Capacidad de carga: 100 kg (par=2 unidades)

CANTIDAD = 1 unidad

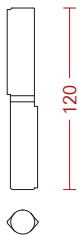

C99003-12



**Weld-on hinge**

Bright steel, Ø16 mm, length 140 mm, with fixed pin and brass intermediate washer.

Capacity: 140 kg (pair=2 pc)

PU = 1 piece

**Cerniera a saldare**

Acciaio decapato, Ø16 mm, lunghezza 140 mm, con perno fisso e rondella intermedia in ottone.

Portata: 140 kg (coppia=2 pezzi)

UV = 1 pezzo

**Bisagra de soldadura**

Acero bruto, diámetro de Ø16 mm, longitud de 140 mm, con perno fijo y anillo intermedio de latón.

Capacidad de carga: 140 kg (par=2 unidades)

CANTIDAD = 1 unidad

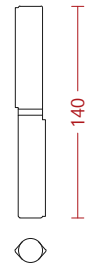

C99004-12

**Weld-on hinge**

Galvanized steel, Ø16 mm, length 140 mm, with galvanized pin and intermediate washer with "loose" pin.

Capacity: 200 kg (pair=2 pc)

PU = 1 piece

**Cerniera a saldare**

Acciaio zincato, Ø16 mm, lunghezza 140 mm, con perno zincato sfilabile e rondella intermedia.

Portata: 200 kg (coppia=2 pezzi)

UV = 1 pezzo

**Bisagra de soldadura**

Acero galvanizado, diámetro de Ø16 mm, longitud de 140 mm, con perno galvanizado y anillo intermedio con pasador "suelto".

Capacidad de carga: 200 kg (par=2 unidades)

CANTIDAD = 1 unidad

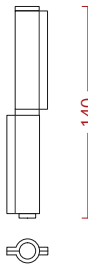

C99005-02

**Weld-on hinge**

Galvanized steel, Ø12 mm, length 80 mm, with galvanized pin and intermediate washer with "loose" pin.

Capacity: 100 kg (pair=2 pc)

-02 = Galvanized steel  
-03 = Stainless steel

PU = 1 piece

**Cerniera a saldare**

Acciaio zincato, Ø12 mm, lunghezza 80 mm, con perno zincato sfilabile e rondella intermedia.

Portata: 100 kg (coppia=2 pezzi)

-02 = Acciaio zincato  
-03 = Acciaio inossidabile

UV = 1 pezzo

**Bisagra de soldadura**

Acero galvanizado, diámetro de Ø12 mm, longitud de 80 mm, con perno galvanizado y anillo intermedio con pasador "suelto".

Capacidad de carga: 100 kg (par=2 unidades)

-02 = Acero galvanizado  
-03 = Acero inoxidable

CANTIDAD = 1 unidad

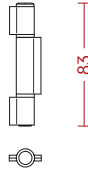

C99006-nn

**Weld-on hinge**

Galvanized steel, Ø16 mm, length 140 mm, 3 pc with galvanized pin and intermediate washer with "loose" pin.

Capacity: 230 kg (pair=2 pc)

PU = 1 piece

**Cerniera a saldare**

Acciaio zincato, Ø16 mm, lunghezza 140 mm, a tre elementi con perno zincato sfilabile e rondella intermedia.

Portata: 230 kg (coppia=2 pezzi)

UV = 1 pezzo

**Bisagra de soldadura**

Acero galvanizado, diámetro de Ø16 mm, longitud de 140 mm, 3 piezas con perno galvanizado y anillo intermedio con pasador "suelto".

Capacidad de carga: 230 kg (par=2 unidades)

CANTIDAD = 1 unidad

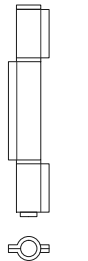

C99007-02

### 3D Weld-on hinge

3-dimensional adjustable hinge for windows and doors.

Length 122 mm, Ø16 mm, with low-maintenance bushes made of brass, eccentric spindle and screw plug made from stainless steel AISI 304

Adjustability:  
Height ±2 mm;  
Lateral contact pressure ±1 mm

Capacity: 160 kg (pair=2 pc)

-04 = Satin stainless steel AISI 304  
-12 = Bright steel  
(End caps in galvanized steel. In case of Cor-Ten finishing needed n°2 Q99966-12).

PU = 1 piece

### Cerniera a saldare regolabile 3D

Cerniera regolabile su tre dimensioni, per finestre o porte. Lunghezza 122 mm, Ø16 mm, con boccole in ottone, perno eccentrico e vite di chiusura in acciaio inox AISI 304

Regolazione:  
Altezza ±2 mm;  
Laterale ±1 mm

Portata: 160 kg (coppia=2 pezzi)

-04 = Acciaio Inox AISI 304 satinato  
-12 = Acciaio decapato  
(Tappi di chiusura in acciaio zincato. In caso di finitura Cor-Ten necessari n°2 Q99966-12).

UV = 1 pezzo

### Bisagra de soldadura en 3D

Bisagra ajustable en 3 dimensiones para ventanas y puertas. Longitud de 122 mm, diámetro de Ø16 mm, con cojinete de deslizamiento de escaso mantenimiento de bronce arquitectónico, perno excéntrico y tornillo de cierre de acero inoxidable AISI 304

Ajustabilidad:  
Altura ±2 mm;  
Laterales ±1 mm

Capacidad de carga: 160 kg (par=2 unidades)

-04 = Acero inoxidable AISI 304 satinado  
-12 = Acero bruto  
(Tapas en acero galvanizado. En caso de acabado Cor-Ten se requieren n°2 Q99966-12).

CANTIDAD = 1 unidad

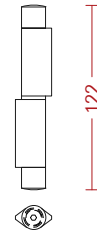

C99008-nn

### End caps for hinges

For Ø16 mm 3D weld-on hinge.

-02 = Galvanized steel  
-04 = Satin Stainless steel AISI 304  
-12 = Bright steel

PU = 1 piece

### Tappi di chiusura per cerniere

Per cerniera a saldare regolabile 3D Ø16 mm

-02 = Acciaio zincato  
-04 = Acciaio Inox AISI 304 satinato  
-12 = Acciaio decapato

UV = 1 pezzo

### Tapas para bisagras

Para bisagra de soldadura en 3 dimensiones Ø16 mm

-02 = Acero galvanizado  
-04 = Acero inoxidable AISI 304 satinado  
-12 = Acero bruto

CANTIDAD = 1 unidad

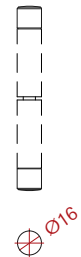

Q99966-nn

### 3D Weld-on hinge

3-dimensional adjustable hinge for windows and doors.

Length 178 mm, Ø20 mm, with low-maintenance bushes made of brass, eccentric spindle and screw plug made from stainless steel AISI 304

Adjustability:  
Height ±2 mm;  
Lateral contact pressure ±1 mm

Capacity: 210 kg (pair=2 pc)

-04 = Satin stainless steel AISI 304  
-12 = Bright steel  
(End caps in galvanized steel. In case of Cor-Ten finishing needed n°2 Q99965-12).

PU = 1 piece

### Cerniera a saldare regolabile 3D

Cerniera regolabile su tre dimensioni, per finestre o porte. Lunghezza 178 mm, Ø20 mm, con boccole in ottone, perno eccentrico e vite di chiusura in acciaio inox AISI 304

Regolazione:  
Altezza ±2 mm;  
Laterale ±1 mm

Portata: 210 kg (coppia=2 pezzi)

-04 = Acciaio Inox AISI 304 satinato  
-12 = Acciaio decapato  
(Tappi di chiusura in acciaio zincato. In caso di finitura Cor-Ten necessari n°2 Q99965-12).

UV = 1 pezzo

### Bisagra de soldadura en 3D

Bisagra ajustable en 3 dimensiones para ventanas y puertas. Longitud de 178 mm, diámetro de Ø20 mm, con cojinete de deslizamiento de bronce mantenimiento de bronce arquitectónico, perno excéntrico y tornillo de cierre de acero inoxidable AISI 304

Ajustabilidad:  
Altura ±2 mm;  
Laterales ±1 mm

Capacidad de carga: 210 kg (par=2 unidades)

-04 = Acero inoxidable AISI 304 satinado  
-12 = Acero bruto  
(Tapas en acero galvanizado. En caso de acabado Cor-Ten se requieren n°2 Q99965-12).

CANTIDAD = 1 unidad

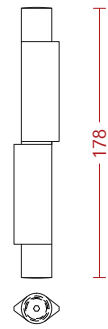

C99009-nn

### End caps for hinges

For Ø20 mm 3D weld-on hinge.

-02 = Galvanized steel  
-04 = Satin Stainless steel AISI 304  
-12 = Bright steel

PU = 1 piece

### Tappi di chiusura per cerniere

Per cerniera a saldare regolabile 3D Ø20 mm

-02 = Acciaio zincato  
-04 = Acciaio Inox AISI 304 satinato  
-12 = Acciaio decapato

UV = 1 pezzo

### Tapas para bisagras

Para bisagra de soldadura en 3 dimensiones Ø20 mm

-02 = Acero galvanizado  
-04 = Acero inoxidable AISI 304 satinado  
-12 = Acero bruto

CANTIDAD = 1 unidad

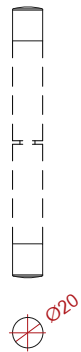

Q99965-nn

**Weld-on hinge**

Weld-on hinge, bright steel, Ø20 mm, length 178 mm, 2-dimensional adjustable.

Capacity: 260 kg (pair=2 pc)

PU = 1 piece

**Cerniera a saldare**

Cerniera a saldare, acciaio decapato, Ø20 mm, lunghezza 178 mm, regolabile su due dimensioni.

Portata: 260 kg (coppia=2 pezzi)

UV = 1 pezzo

**Bisagra de soldadura**

Bisagra de soldadura, acero bruto, Ø20 mm, longitud 178 mm, tres elementos, ajustable en 2 dimensiones, coplanar.

Capacidad de carga: 260 kg (par=2 unidades)

CANTIDAD = 1 unidad

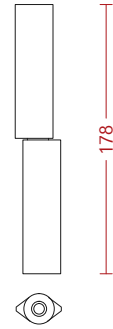

C99120-12

**Screw-on hinge**

Screw-on hinge, Ø17 mm, length 152 mm, 3-wings, not adjustable, for flush profiles.

Capacity: 140 kg (pair=2 pc)

- 02 = Galvanized steel
- 04 = Satin stainless steel AISI 304
- 12 = Bright steel

PU = 1 piece

**Cerniera ad avvitare**

Cerniera ad avvitare, Ø17 mm, lunghezza 152 mm, a tre elementi, non regolabile, per profili complanare.

Portata: 140 kg (coppia=2 pezzi)

- 02 = Acciaio zincato
- 04 = Acciaio Inox AISI 304 satinato
- 12 = Acciaio decapato

UV = 1 pezzo

**Bisagra atornillable**

Bisagra para atornillar, Ø17 mm, longitud 152 mm, tres elementos, no regulable, para perfiles coplanar.

Capacidad de carga: 140 kg (par=2 unidades)

- 02 = Acero galvanizado
- 04 = Acero inoxidable AISI 304 satinado
- 12 = Acero bruto

CANTIDAD = 1 unidad

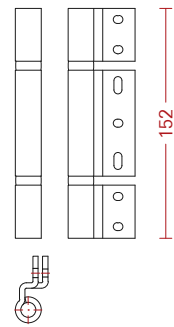

C99121-nn

**Screw-on hinge**

Screw-on hinge, Ø17 mm, length 182 mm, 3-wings, not adjustable, for flush profiles.

Capacity: 160 kg (pair=2 pc)

- 02 = Galvanized steel
- 04 = Satin stainless steel AISI 304
- 12 = Bright steel

PU = 1 piece

**Cerniera ad avvitare**

Cerniera ad avvitare, Ø17 mm, lunghezza 182 mm, a tre elementi, non regolabile, complanare.

Portata: 160 kg (coppia=2 pezzi)

- 02 = Acciaio zincato
- 04 = Acciaio Inox AISI 304 satinato
- 12 = Acciaio decapato

UV = 1 pezzo

**Bisagra atornillable**

Bisagra para atornillar, Ø17 mm, longitud 182 mm, tres elementos, no regulable, para perfiles coplanar.

Capacidad de carga: 160 kg (par=2 unidades)

- 02 = Acero galvanizado
- 04 = Acero inoxidable AISI 304 satinado
- 12 = Acero bruto

CANTIDAD = 1 unidad

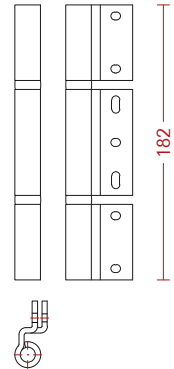

C99122-nn

**Screw-on hinge**

Screw-on hinge, Ø17 mm, length 152 mm, 3-wings, not adjustable, for overlapped profiles.

Capacity: 140 kg (pair=2 pc)

- 02 = Galvanized steel
- 04 = Satin stainless steel AISI 304
- 12 = Bright steel

PU = 1 piece

**Cerniera ad avvitare**

Cerniera ad avvitare, Ø17 mm, lunghezza 152 mm, a tre elementi, non regolabile, per profili a sormonto.

Portata: 140 kg (coppia=2 pezzi)

- 02 = Acciaio zincato
- 04 = Acciaio Inox AISI 304 satinato
- 12 = Acciaio decapato

UV = 1 pezzo

**Bisagra atornillable**

Bisagra para atornillar, Ø17 mm, longitud 152 mm, tres elementos, no regulable, para perfiles superpuestos.

Capacidad de carga: 140 kg (par=2 unidades)

- 02 = Acero galvanizado
- 04 = Acero inoxidable AISI 304 satinado
- 12 = Acero bruto

CANTIDAD = 1 unidad

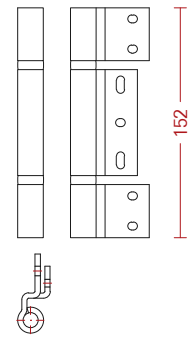

C99123-**nn**

**Screw-on hinge**

Screw-on hinge, Ø17 mm, length 182 mm, 3-wings, not adjustable, for overlapped profiles.

Capacity: 160 kg (pair=2 pc)

- 02 = Galvanized steel
- 04 = Satin stainless steel AISI 304
- 12 = Bright steel

PU = 1 piece

**Cerniera ad avvitare**

Cerniera ad avvitare, Ø17 mm, lunghezza 182 mm, a tre elementi, non regolabile, per profili a sormonto.

Portata: 160 kg (coppia=2 pezzi)

- 02 = Acciaio zincato
- 04 = Acciaio Inox AISI 304 satinato
- 12 = Acciaio decapato

UV = 1 pezzo

**Bisagra atornillable**

Bisagra para atornillar, Ø17 mm, longitud 182 mm, tres elementos, no regulable, para perfiles superpuestos.

Capacidad de carga: 160 kg (par=2 unidades)

- 02 = Acero galvanizado
- 04 = Acero inoxidable AISI 304 satinado
- 12 = Acero bruto

CANTIDAD = 1 unidad

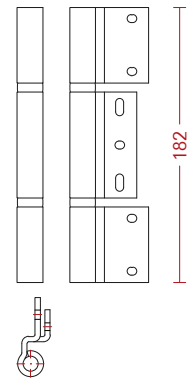

C99124-**nn**

**Screw-on hinge**

Screw-on hinge, Ø17 mm, length 152 mm, 3-wings, 1-dimensional adjustable, for Tilt&Turn profiles.

Capacity: 140 kg (pair=2 pc)

- 02 = Galvanized steel
- 04 = Satin stainless steel AISI 304
- 12 = Bright steel

PU = 1 piece

**Cerniera ad avvitare**

Cerniera ad avvitare, Ø17 mm, lunghezza 152 mm, a tre elementi, regolabile su una dimensione, per profili anta ribalta.

Portata: 140 kg (coppia=2 pezzi)

- 02 = Acciaio zincato
- 04 = Acciaio Inox AISI 304 satinato
- 12 = Acciaio decapato

UV = 1 pezzo

**Bisagra atornillable**

Bisagra para atornillar, Ø17 mm, longitud 152 mm, tres elementos, ajustable en 1 dimensión, para perfiles de ventana oscilante.

Capacidad de carga: 140 kg (par=2 unidades)

- 02 = Acero galvanizado
- 04 = Acero inoxidable AISI 304 satinado
- 12 = Acero bruto

CANTIDAD = 1 unidad

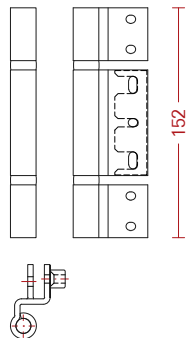

C99127-**nn**

**Screw-on hinge**

Screw-on hinge, Ø17 mm, length 182 mm, 3-wings, 1-dimensional adjustable, for Tilt&Turn profiles.

Capacity: 160 kg (pair=2 pc)

- 02 = Galvanized steel
- 04 = Satin stainless steel AISI 304
- 12 = Bright steel

PU = 1 piece

**Cerniera ad avvitare**

Cerniera ad avvitare, Ø17 mm, lunghezza 182 mm, a tre elementi, regolabile su una dimensione, per profili anta ribalta.

Portata: 160 kg (coppia=2 pezzi)

- 02 = Acciaio zincato
- 04 = Acciaio Inox AISI 304 satinato
- 12 = Acciaio decapato

UV = 1 pezzo

**Bisagra atornillable**

Bisagra para atornillar, Ø17 mm, longitud 182 mm, tres elementos, ajustable en 1 dimensión, para perfiles de ventana oscilante.

Capacidad de carga: 160 kg (par=2 unidades)

- 02 = Acero galvanizado
- 04 = Acero inoxidable AISI 304 satinado
- 12 = Acero bruto

CANTIDAD = 1 unidad

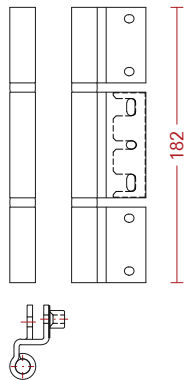

C99128-**nn**

### Screw-on hinge

Screw-on hinge, Ø15 mm, length 90 mm, 3-wings, 2-dimensional adjustable, for flush and overlapped profiles.

Capacity: 100 kg (pair=2 pc)

-02 = Galvanized steel  
-04 = Satin Stainless steel AISI 304

PU = 1 piece

### Cerniera ad avvitare

Cerniera ad avvitare, Ø15 mm, lunghezza 90 mm, a tre elementi, regolabile su due dimensioni, per profili complanari e a sormonto.

Portata: 100 kg (coppia=2 pezzi)

-02 = Acciaio zincato  
-04 = Acciaio Inox AISI 304 satinato

UV = 1 pezzo

### Bisagra atornillable

Bisagra para atornillar, Ø15 mm, longitud 90 mm, tres elementos, ajustable en 2 dimensiones, para perfiles coplanar y superpuestos.

Capacidad de carga: 100 kg (par=2 unidades)

-02 = Acero galvanizado  
-04 = Acero inoxidable AISI 304 satinado

CANTIDAD = 1 unidad

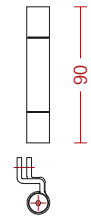

C99154-**nn**

### Screw-on hinge

Screw-on hinge, Ø22.5 mm, length 160 mm, 3-wings, 2-dimensional adjustable, for flush profiles.

Capacity: 150 kg (pair=2 pc)

-02 = Galvanized steel  
-04 = Satin stainless steel AISI 304

PU = 1 piece

### Cerniera ad avvitare

Cerniera ad avvitare, Ø22.5 mm, lunghezza 160 mm, a tre elementi, regolabile su due dimensioni, per profili complanari.

Portata: 150 kg (coppia=2 pezzi)

-02 = Acciaio zincato  
-04 = Acciaio Inox AISI 304 satinato

UV = 1 pezzo

### Bisagra atornillable

Bisagra para atornillar, Ø22.5 mm, longitud 160 mm, tres elementos, ajustable en 2 dimensiones, para perfiles coplanar.

Capacidad de carga: 150 kg (par=2 unidades)

-02 = Acero galvanizado  
-04 = Acero inoxidable AISI 304 satinado

CANTIDAD = 1 unidad

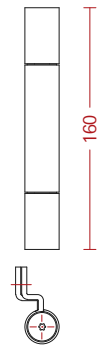

C99155-**nn**

### Screw-on hidden hinge

Concealed hinge, black cathaphoresis, for door profiles. Maximum opening 90°.

Capacity: 160 kg (pair=2 pc)

PU = 1 piece

### Cerniera ad avvitare a scomparsa

Cerniera a scomparsa in cataforesi nera, per profili porta. Apertura massima 90°.

Portata: 160 kg (coppia=2 pezzi)

UV = 1 pezzo

### Bisagra oculta atornillable

Bisagra oculta en cataforesis negra, para perfiles de puerta. Apertura máxima de 90°.

Capacidad de carga: 160 kg (par=2 unidades)

CANTIDAD = 1 unidad

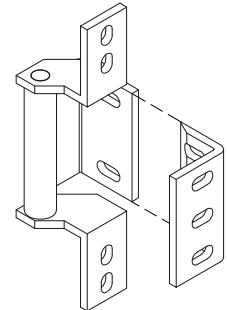

C99403-46

### Pivot hinge

Capacity:  
vertical pivot: max weight 300 kg  
horizontal pivot: max weight 200 kg

-05 = Stainless steel AISI 316L 2B compatible with galvanized steel (-02) and stainless steel (-05) profiles.

-12 = Bright steel compatible with Cor-Ten steel (-07) and bright steel (-12) profiles.

PU = 1 piece

### Cerniera pivot

Portata:  
bilico verticale: peso max 300 kg  
bilico orizzontale: peso max 200 kg

-05 = Acciaio inox AISI 316L 2B compatibile con i profili in acciaio zincato (-02) e acciaio inox (-05).

-12 = Acciaio decapato compatibile con i profili in acciaio Cor-Ten (-07) e acciaio decapato (-12).

UV = 1 pezzo

### Bisagra pivote

Capacidad de carga:  
pivote vertical: peso máximo 300 kg  
pivote horizontal: peso máximo 200 kg

-05 = Acero inoxidable AISI 316L 2B compatible con perfiles en acero galvanizado (-02) y acero inoxidable (-05).

-12 = Acero bruto compatible con perfiles en acero Cor-Ten (-07) y acero bruto (-12).

CANTIDAD = 1 unidad

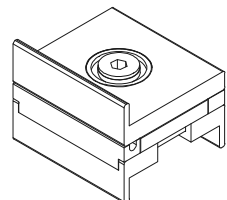

C99327-**nn**

**Friction stay (projecting)**

Stainless steel AISI 316, for open out top hung projecting windows with adjustable opening angles.

**Bracci portanti a sporgere**

Acciaio inox AISI 316, per finestra a sporgere apertura esterna con angolo di apertura regolabile.

**Bisagra proyectante**

Acero inoxidable AISI 316, para ventana proyectante que se abre hacia fuera con ángulo de apertura ajustable.

Code Codice Code	Capacity Portata Capacidad [kg]	H size H dimensione H tamaño [mm]	Opening angle Angolo di apertura Ángulo de apertura [°]
C99201-05	40	270-640	50
C99202-05	50	640-800	50
C99203-05	65	800-1100	50
C99204-05	100	600-1100	30
C99205-05	100	1100-1500	45
C99206-05	100	1500-2000	20
C99207-05	180	2000-2500	20

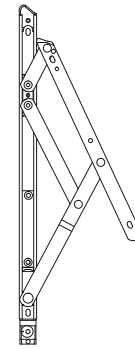

C9920X-05

PU = 1 pair

UV = 1 coppia

CANTIDAD = 1 par

**Friction stay (turn)**

Stainless steel AISI 316, for open in or open out side hung windows.

**Bracci portanti anta battente**

Acciaio inox AISI 316, per finestra battente ad apertura verso l'interno o l'esterno.

**Bisagra abatible**

Acero inoxidable AISI 316, para ventana abatible que se abre hacia dentro o hacia fuera.

Code Codice Code	Capacity Portata Capacidad [kg]	H size H dimensione H tamaño [mm]	Opening angle Angolo di apertura Ángulo de apertura [°]
C99210-05	22	300-600	80
C99211-05	24	400-700	90
C99212-05	38	300-660	85
C99213-05	55	450-840	60

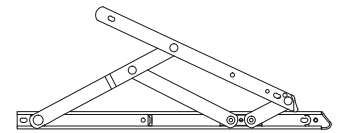

C9921X-05

PU = 1 pair

UV = 1 coppia

CANTIDAD = 1 par





**Flush bolts**

**Catenacci**

**Pasador de canto**

**3.4**

**Flush bolt  
for windows**

Concealed.

Finishings:

15 17 18 42 43

PU = 1 piece

**Catenaccio  
per finestra**

Interno.

Finiture:

15 17 18 42 43

UV = 1 pezzo

**Pasador de canto  
para ventanas**

Oculto.

Acabados:

15 17 18 42 43

CANTIDAD = 1 unidad

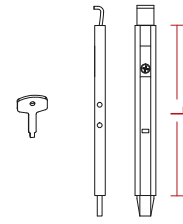

code L  
E99001-nn 150 mm  
E99002-nn 300 mm  
E99003-nn 450 mm

**Extension**

Extension for flush bolt E99001-nn,  
E99002-nn, E99003-nn

Finishings:

15 17 18 42 43

PU = 1 piece

**Prolunga**

Prolunga per catenacci E99001-nn,  
E99002-nn, E99003-nn

Finiture:

15 17 18 42 43

UV = 1 pezzo

**Extensión**

Extensión para pasador de canto  
E99001-nn, E99002-nn, E99003-nn

Acabados:

15 17 18 42 43

CANTIDAD = 1 unidad

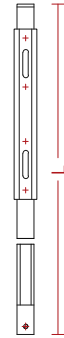

code L  
E99004-nn 424 mm

**Flush bolt  
for windows**

Visible.

Finishings:

15 17 18 42 43

PU = 1 piece

**Catenaccio  
per finestra**

A vista.

Finiture:

15 17 18 42 43

UV = 1 pezzo

**Pasador de canto  
para ventanas**

Visible.

Acabados:

15 17 18 42 43

CANTIDAD = 1 unidad

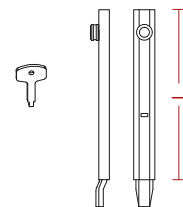

code L  
E99005-nn 150 mm  
E99006-nn 300 mm  
E99007-nn 450 mm

**Flush bolt with lever  
for doors**

Concealed.

PU = 1 piece

**Catenaccio con leva  
per porte**

Interno.

UV = 1 pezzo

**Pasador de canto  
para puertas**

Oculto.

CANTIDAD = 1 unidad

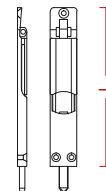

code L  
E99021-35 140 mm  
E99022-35 220 mm  
E99023-35 450 mm  
E99024-35 650 mm

**Strike plate**

PU = 1 piece

**Riscontro**

UV = 1 pezzo

**Chapa de cierre**

CANTIDAD = 1 unidad

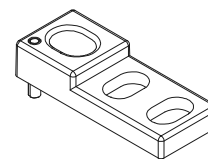

E99012-11

**Floor recess plate**

PU = 1 piece

**Pozzetto**

UV = 1 pezzo

**Cavidad en el suelo**

CANTIDAD = 1 unidad

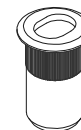

E99013-05

**Strike plate**

Fastening with screws  
M4x10 mm ISO7380

PU = 1 piece

**Riscontro**

Fissaggio con viti  
M4x10 mm ISO7380

UV = 1 pezzo

**Pieza de bloqueo**

Fijación con tornillos  
M4x10 mm ISO7380

CANTIDAD = 1 unidad

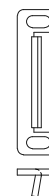

E99116-03

**Shoot bolt for door**

PU = 1 piece

**Catenaccio per porte**

UV = 1 pezzo

**Pasador de canto para puertas**

CANTIDAD = 1 unidad

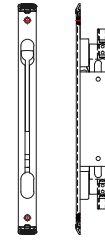

E99035-02

**Rod guide**

Lower rod guide  
door shoot bolt.

-03 = Stainless steel AISI 304 2B

PU = 1 piece

**Guida asta**

Guida asta inferiore catenaccio per  
porte.

-03 = Acciaio inossidabile AISI 304 2B

UV = 1 pezzo

**Guía de subasta**

Guía de pasador de canto inferior  
para puertas.

-03 = Acero inoxidable AISI 304 2B

CANTIDAD = 1 unidad

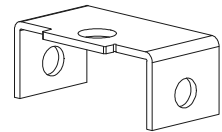

E99036-03

**Rod guide**

Upper rod guide  
door shoot bolt.

-04 = Satin stainless steel AISI 304

PU = 1 piece

**Guida asta**

Guida asta superiore catenaccio  
per porte.

-04 = Acciaio Inox AISI 304 satinato

UV = 1 pezzo

**Guía de subasta**

Guía de pasador de canto  
superior para puertas.

-04 = Acero inoxidable AISI 304 satinado

CANTIDAD = 1 unidad

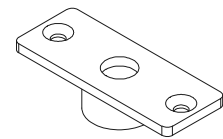

E99037-04

**Rod guide**

Middle rod guide  
door shoot bolt.

-04 = Satin stainless steel AISI 304

PU = 1 piece

**Guida asta**

Guida asta intermedio catenaccio  
per porte.

-04 = Acciaio Inox AISI 304 satinato

UV = 1 pezzo

**Guía de subasta**

Guía de pasador de canto  
intermedio para puertas.

-04 = Acero inoxidable AISI 304 satinado

CANTIDAD = 1 unidad

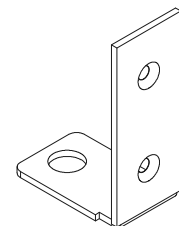

E99038-04

**Strike plate**

Upper strike rod  
door shoot bolt.

-04 = Satin stainless steel AISI 304

PU = 1 piece

**Riscontro**

Riscontro superiore  
catenaccio per porte.

-04 = Acciaio Inox AISI 304 satinato

UV = 1 pezzo

**Pieza de bloqueo**

Pieza de pasador de canto  
superior para puertas.

-04 = Acero inoxidable AISI 304 satinado

CANTIDAD = 1 unidad

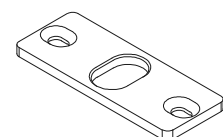

E99039-04

**Upper and lower long shoot bolt**

-04 = Satin stainless steel AISI 304

PU = 1 piece

**Catenaccio lungo superiore e inferiore**

-04 = Acciaio Inox AISI 304 satinato

UV = 1 pezzo

**Pasador de canto largo superior y inferior**

-04 = Acero inoxidable AISI 304 satinado

CANTIDAD = 1 unidad

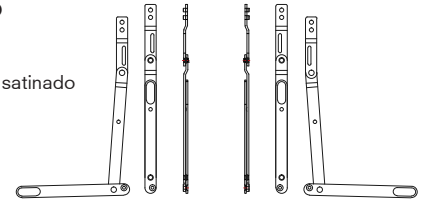

E99040-04  
E99041-04

**Strike plate**

Strike plate for long shoot bolt.

-04 = Satin stainless steel AISI 304

PU = 1 piece

**Riscontro**

Riscontro per catenaccio lungo.

-04 = Acciaio Inox AISI 304 satinato

UV = 1 pezzo

**Pieza de bloqueo**

Pieza de pasador de canto largo.

-04 = Acero inoxidable AISI 304 satinado

CANTIDAD = 1 unidad

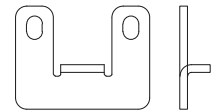

E99052-04

**Strike plate**

Strike plate for long shoot bolt.

-04 = Satin stainless steel AISI 304

PU = 1 piece

**Riscontro**

Riscontro per catenaccio lungo.

-04 = Acciaio Inox AISI 304 satinato

UV = 1 pezzo

**Pieza de bloqueo**

Pieza de pasador de canto largo.

-04 = Acero inoxidable AISI 304 satinado

CANTIDAD = 1 unidad

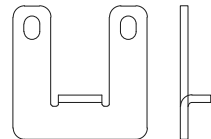

E99053-04

**Rod**

Rod for long shoot bolt.

E99042-04 L = 720 mm  
E99043-04 L = 1360 mm  
E99044-04 L = 2000 mm

-04 = Satin stainless steel AISI 304

PU = 1 piece

**Asta**

Asta per catenaccio lungo.

E99042-04 L = 720 mm  
E99043-04 L = 1360 mm  
E99044-04 L = 2000 mm

-04 = Acciaio Inox AISI 304 satinato

UV = 1 pezzo

**Subasta**

Subasta para pasador de canto largo.

E99042-04 L = 720 mm  
E99043-04 L = 1360 mm  
E99044-04 L = 2000 mm

-04 = Acero inoxidable AISI 304 satinado

CANTIDAD = 1 unidad

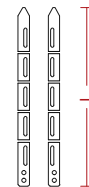

E9904X-04

**Reinforcement rod**

Reinforcement rod for long shoot bolt.

-04 = Satin stainless steel AISI 304

PU = 1 piece

**Asta di rinforzo**

Asta di rinforzo per catenaccio lungo.

-04 = Acciaio Inox AISI 304 satinato

UV = 1 pezzo

**Subasta de reforzamiento**

Subasta de reforzamiento para pasador de canto largo.

-04 = Acero inoxidable AISI 304 satinado

CANTIDAD = 1 unidad



E99045-04



**General fittings**

**Ferramenta generale**

**Herrajes generales**

**3.5**

### Opening restrictor

Concealed opening restrictor, right/left, fastening with screws.

-02 = Galvanized steel

PU = 1 pair

### Limitatore di apertura

Limitatore di apertura a scomparsa con apertura destra/sinistra, fissaggio con viti.

-02 = Acciaio zincato

UV = 1 coppia

### Limitador de apertura

Limitador de apertura oculto que se abre hacia la derecha/izquierda, fijación con tornillos.

-02 = Acero galvanizado

CANTIDAD = 1 par

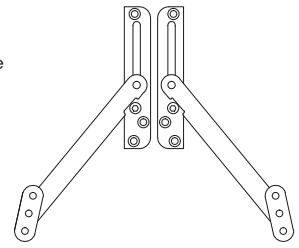

E99201-02

### Opening restrictor

Concealed opening restrictor, top-hung windows, open in and open out.

-05 = Stainless steel AISI 316L 2B

Capacity: 110 kg (pair)

PU = 1 pair

### Limitatore di apertura

Limitatore di apertura a scomparsa, finestra a sporgere, apertura interna ed esterna.

-05 = Acciaio inox AISI 316L 2B

Portata: 110 kg (coppia)

UV = 1 coppia

### Limitador de apertura

Limitador de apertura oculto, ventana proyectante, apertura hacia dentro y hacia fuera.

-05 = Acero inoxidable AISI 316L 2B

Capacidad de carga: 110 kg (par)

CANTIDAD = 1 par



E99203-05

### Opening restrictor

Opening restrictor for ironmongery groove profiles. Galvanized steel.

PU = 1 piece

### Limitatore di apertura

Limitatore apertura per profili cava ferramenta. Acciaio zincato.

UV = 1 pezzo

### Limitador de apertura

Limitador de apertura para perfiles ranurados de ferretería. Acero galvanizado.

CANTIDAD = 1 unidad

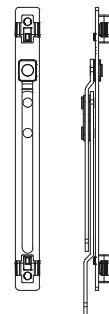

K88033

### Opening restrictor

Concealed opening restrictor, bottom hung windows, open in and open out.

-05 = Stainless steel AISI 316L 2B

Capacity: 110 kg (pair)

PU = 1 pair

### Limitatore di apertura

Limitatore di apertura a scomparsa, vasistas, apertura interna ed esterna.

-05 = Acciaio inox AISI 316L 2B

Portata: 110 kg (coppia)

UV = 1 coppia

### Limitador de apertura

Limitador de apertura oculto, ventana batiente, apertura hacia dentro y hacia fuera.

-05 = Acero inoxidable AISI 316L 2B

Capacidad de carga: 110 kg (par)

CANTIDAD = 1 par



E99205-05



**Automatic drop seal**

Automatic drop seal with 14 mm lift height, floor compensation.

**Guarnizione a ghigliottina**

Guarnizione a ghigliottina (14 mm compensazione), automatica a pavimento.

**Junta de suelo automática**

Junta de suelo descendente con un desplazamiento de 14 mm, descenso paralelo con compensación de suelo automática.

Code Codice Code	Length Lunghezza Tamaño	Can be shortened Accorciabile Reducible
G99501-62	330 mm	50 mm
G99502-62	430 mm	135 mm
G99503-62	530 mm	200 mm
G99504-62	630 mm	200 mm
G99505-62	730 mm	200 mm
G99506-62	830 mm	200 mm
G99507-62	930 mm	200 mm
G99508-62	1030 mm	200 mm
G99509-62	1130 mm	200 mm
G99510-62	1230 mm	200 mm

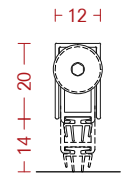

G995XX-62

PU = 1 piece

UV = 1 pezzo

CANTIDAD = 1 unidad

**Lateral cover cap for automatic drop seal**

-35 = black  
-41 = RAL 7035 grey

PU = 1 pair

**Tappo laterale per guarnizione a ghigliottina**

-35 = nero  
-41 = grigio RAL 7035

UV = 1 coppia

**Tapa lateral para junta de suelo automática**

-35 = negro  
-41 = gris RAL 7035

CANTIDAD = 1 par

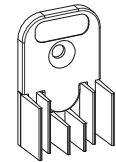

G99511-nn

**Handle and cremone  
for round rods**

PU = 1 piece

**Maniglia e cremone  
a ridosso per aste tonde**

UV = 1 pezzo

**Manilla y falleba  
para varillas redondas**

CANTIDAD = 1 unidad

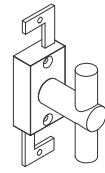

H99026-26

**Pass through guide  
for round rods**

27x16 mm

**Passante asta  
cremonese tonda**

27x16 mm

**Guía de paso  
para varillas redondas**

27x16 mm

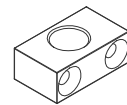

E99144-26

**Strike plate  
for round rod**

32x16 mm

**Riscontro per asta  
cremonese tonda**

32x16 mm

**Chapa de cierre  
para varillas redondas**

32x16 mm

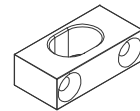

E99145-26

**Strike plate  
for round rod**

32x24 mm

**Riscontro per asta  
cremonese tonda**

32x24 mm

**Chapa de cierre  
para varillas redondas**

32x24 mm

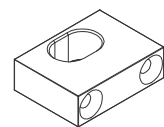

E99148-26

**Round cremone rod**

E99141-26 L = 1000 mm  
E99142-26 L = 1500 mm  
E99143-26 L = 3000 mm

**Asta cremonese tonda**

E99141-26 L = 1000 mm  
E99142-26 L = 1500 mm  
E99143-26 L = 3000 mm

**Varilla de falleba redonda**

E99141-26 L = 1000 mm  
E99142-26 L = 1500 mm  
E99143-26 L = 3000 mm

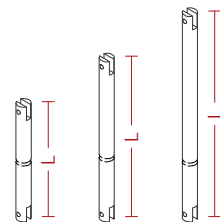

E9914X-26

**Handle spindle**

-02 = Galvanized Steel  
☒ 8 mm L=140 mm  
PU = 1 piece

**Quadro maniglia**

-02 = Acciaio zincato  
☒ 8 mm L=140 mm  
UV = 1 pezzo

**Pasador de la manilla**

☒ 8 mm L=140 mm  
CANTIDAD = 1 unidad

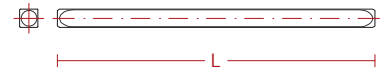

E99551-02

**Reducing sleeve  
8 mm to 7 mm**

-02 = Galvanized Steel  
☒ 7 mm  
PU = 1 piece

**Riduttore quadro  
da 8 mm a 7 mm**

-02 = Acciaio zincato  
☒ 7 mm  
UV = 1 pezzo

**Manguito reductor  
de 8 mm a 7 mm**

-02 = Acero galvanizado  
☒ 7 mm  
CANTIDAD = 1 unidad

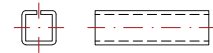

E99531-02

**Adjustment bush  
for fixing**

M8x10 + 15x1 Ø5  
-02 = Galvanized steel  
-03 = Stainless steel AISI 304 2B  
PU = 50 pieces

**Bussola di regolazione  
per fissaggio**

M8x10 + 15x1 Ø5  
-02 = Acciaio zincato  
-03 = Acciaio inossidabile AISI 304 2B  
UV = 50 pezzi

**Cojinete de regulación  
para arreglar**

M8x10 + 15x1 Ø5  
-02 = Acero galvanizado  
-03 = Acero inoxidable AISI 304 2B  
CANTIDAD = 50 unidades

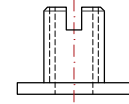

F99065-nn

**Gasket  
for lever handle**

Gasket for lever handle H99001-nn,  
140x16.5x6 mm  
-63 = Polyethylene  
PU = 1 piece

**Guarnizione  
per cariglione**

Guarnizione per cariglione  
H99001-nn, 140x16.5x6 mm  
-63 = Polietilene  
UV = 1 pezzo

**Junta para manija  
de bloqueo**

Junta para manija de bloqueo  
H99001-nn, 140x16.5x6 mm  
-63 = Polietileno  
CANTIDAD = 1 unidad



G99407-63



**Locks**

**Serrature**

**Cerraduras**

**3.6**

### Mortise lock

Single latch and deadbolt, faceplate 24x6 mm, backset 35 mm, galvanized steel strike plate 24x6 mm included, handle/lock distance 92 mm

-02 = Galvanized steel

PU = 1 piece

### Serratura con scrocco e mandata

Serratura con scrocco e mandata, frontale 24x6 mm, entrata 35 mm, riscontro in acciaio zincato 24x6 mm incluso, interasse maniglia/cilindro 92 mm

-02 = Acciaio zincato

UV = 1 pezzo

### Cerradura de pestillo y cerrojo

Cerradura empotrable 24x6 mm, medida de aguja de 35 mm, chapa de cierre de acero galvanizado 24x6 mm incluido, distancia manilla/cilindro 92 mm

-02 = Acero galvanizado

CANTIDAD = 1 unidad



B99015-02

### Multi-point locking

3-point locking device with black faceplate 24x7 mm, latch and deadbolt, locking upwards and downwards, backset 35 mm, galvanized steel strike plate 25x3 mm, handle/lock distance 85 mm

-02 = Galvanized steel

PU = 1 piece

### Serratura multipunto

Serratura a tre punti di chiusura con scrocco e mandata, frontale colore nero 24x7 mm, chiusura alto e basso, entrata 35 mm, riscontro in acciaio zincato 25x3 mm, interasse maniglia/cilindro 85 mm

-02 = Acciaio zincato

UV = 1 pezzo

### Cerradura múltiple

Bloqueo de 3 puntos con pestillo y cerrojo de color negro 24x7 mm, bloqueo hacia arriba y hacia abajo, medida de aguja de 35 mm, chapa de acero galvanizado de 25x3 mm, distancia manilla/cilindro 85 mm

-02 = Acero galvanizado

CANTIDAD = 1 unidad



B99111-02

### Lock extension

Extension for multi-point lock B99170-02 and B99171-02, galvanized steel faceplate 24x6 mm

-02 = Galvanized steel

PU = 1 piece

### Prolunga serratura

Prolunga per serratura multipunto B99170-02 e B99171-02, frontale in acciaio zincato 24x6 mm

-02 = Acciaio zincato

UV = 1 pezzo

### Extensión de bloqueo

Prolongación para cerradura multipunto B99170-02 y B99171-02, frontal en acero galvanizado 24x6 mm

-02 = Acero galvanizado

CANTIDAD = 1 unidad



B99169-02

### Multi-point locking

3-point locking device with black faceplate 24x7 mm, latch and deadbolt, locking upwards and downwards, backset 35 mm, handle/lock distance 85 mm, extendable lock.

-02 = Galvanized steel

PU = 1 piece

### Serratura multipunto

Serratura a tre punti di chiusura con scrocco e mandata, frontale colore nero 24x7 mm, chiusura alto e basso, entrata 35 mm, interasse maniglia/cilindro 85 mm, serratura estensibile.

-02 = Acciaio zincato

UV = 1 pezzo

### Cerradura múltiple

Bloqueo de 3 puntos con pestillo y cerrojo de color negro 24x7 mm, bloqueo hacia arriba y hacia abajo, medida de aguja de 35 mm, distancia manilla/cilindro 85 mm, cerradura extensible.

-02 = Acero galvanizado

CANTIDAD = 1 unidad



B99170-02

### Multi-point locking

3-point locking device with black faceplate 24x6 mm, latch and deadbolt, locking upwards and downwards, backset 35 mm, handle/lock distance 92 mm, extendable lock.

-02 = Galvanized steel

PU = 1 piece

### Serratura multipunto

Serratura a tre punti di chiusura con scrocco e mandata, frontale colore nero 24x6 mm, chiusura alto e basso, entrata 35 mm, interasse maniglia/cilindro 92 mm, serratura estensibile.

-02 = Acciaio zincato

UV = 1 pezzo

### Cerradura múltiple

Bloqueo de 3 puntos con pestillo y cerrojo de color negro 24x6 mm, bloqueo hacia arriba y hacia abajo, medida de aguja de 35 mm, distancia manilla/cilindro 92 mm, cerradura extensible.

-02 = Acero galvanizado

CANTIDAD = 1 unidad



B99171-02

### Multi-point locking

3-point locking device with black faceplate 24x6 mm, latch and deadbolt, locking upwards and downwards, backset 35 mm, handle/lock distance 92 mm, automatic latchbolts, extendable lock.

-02 = Galvanized steel

PU = 1 piece

### Serratura multipunto

Serratura a tre punti di chiusura con scrocco e mandata, frontale colore nero 24x6 mm, chiusura alto e basso, entrata 35 mm, interasse maniglia/cilindro 92 mm, scroccchi automatici, serratura estensibile.

-02 = Acciaio zincato

UV = 1 pezzo

### Cerradura múltiple

Bloqueo de 3 puntos con pestillo y cerrojo de color negro 24x6 mm, bloqueo hacia arriba y hacia abajo, medida de aguja de 35 mm, distancia manilla/cilindro 92 mm, pestillos automáticos, cerradura extensible.

-02 = Acero galvanizado

CANTIDAD = 1 unidad



B99173-02

### Multi-point locking

5-point locking device, deadbolt and head locking, faceplate 24x6 mm, backset 45 mm, handle/lock distance 92 mm, extendable lock, minimum vent height 1950 mm

-02 = Galvanized steel

PU = 1 piece

### Serratura multipunto

Serratura a cinque punti di chiusura con scrocco, mandata e ganci, frontale 24x6 mm, entrata 45 mm, interasse maniglia/cilindro 92 mm, serratura estensibile, altezza minima anta 1950 mm

-02 = Acciaio zincato

UV = 1 pezzo

### Cerradura múltiple

Bloqueo de 5 puntos 24x6 mm, mandril + bloqueo de gancho, medida de aguja de 45 mm, distancia manilla/cilindro 92 mm, cerradura extensible, altura mínima hoja 1950 mm

-02 = Acero galvanizado

CANTIDAD = 1 unidad



B99174-02

### Multi-point locking

5-point locking device, deadbolt and head locking, faceplate 24x6 mm, backset 80 mm, handle/lock distance 92 mm, extendable lock, minimum vent height 1950 mm

-02 = Galvanized steel

PU = 1 piece

### Serratura multipunto

Serratura a cinque punti di chiusura con scrocco, mandata e ganci, frontale 24x6 mm, entrata 80 mm, interasse maniglia/cilindro 92 mm, serratura estensibile, altezza minima anta 1950 mm

-02 = Acciaio zincato

UV = 1 pezzo

### Cerradura múltiple

Bloqueo de 5 puntos 24x6 mm, mandril + bloqueo de gancho, medida de aguja de 80 mm, distancia manilla/cilindro 92 mm, cerradura extensible, altura mínima hoja 1950 mm

-02 = Acero galvanizado

CANTIDAD = 1 unidad



B99175-02

### French casement drive gear

French casement drive gear for B99171-02 lock, faceplate 24x6 mm, H 2150 mm

-02 = Galvanized steel

R = Right opening

PU = 1 piece

### Asta a leva cava

Asta a leva per serratura B99171-02, frontale 24x6 mm, H 2150 mm

-02 = Acciaio zincato

R = Apertura destra

UV = 1 pezzo

### Varilla de palanca

Varilla de palanca para cerradura B99171-02, frente 24x6 mm, H 2150 mm

-02 = Acero galvanizado

R = Apertura derecha

CANTIDAD = 1 unidad

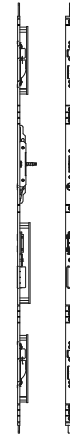

B99162-02

### French casement drive gear

French casement drive gear for B99171-02 lock, faceplate 24x6 mm, H 2150 mm

-02 = Galvanized steel

L = Left opening

PU = 1 piece

### Asta a leva cava

Asta a leva per serratura B99171-02, frontale 24x6 mm, H 2150 mm

-02 = Acciaio zincato

L = Apertura sinistra

UV = 1 pezzo

### Varilla de palanca

Varilla de palanca para cerradura B99171-02, frente 24x6 mm, H 2150 mm

-02 = Acero galvanizado

L = Apertura izquierda

CANTIDAD = 1 unidad



B99163-02



**Extension**

Extension for french casement drive gear B99162-02 and B99163-02, faceplate 24x6 mm, L 700 mm

-02 = Galvanized steel

PU = 1 piece

**Prolunga**

Prolunga per asta a leva B99162-02 e B99163-02, frontale 24x6 mm, L 700 mm

-02 = Acciaio zincato

UV = 1 pezzo

**Extensión**

Extensión para varilla de palanca B99162-02 y B99163-02, frente 24x6 mm, L 700 mm

-02 = Acero galvanizado

CANTIDAD = 1 unidad



B99164-02

**Shoot bolt**

Shoot bolt for french casement drive gear B99162-02 and B99163-02, faceplate 24x6 mm, L 530 mm

-02 = Galvanized steel

PU = 1 piece

**Puntale**

Puntale per asta a leva B99162-02 e B99163-02, frontale 24x6 mm, L 530 mm

-02 = Acciaio zincato

UV = 1 pezzo

**Pasador de canto**

Pasador de canto para varilla de palanca B99162-02 y B99163-02, frente 24x6 mm, L 530 mm

-02 = Acero galvanizado

CANTIDAD = 1 unidad



B99165-02

**Strike plate**

PU = 1 piece

**Riscontro**

UV = 1 pezzo

**Pieza de bloqueo**

CANTIDAD = 1 unidad

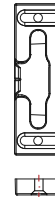

B99201-11

**Central strike plate**

Central strike plate for 3-point locking device B99170-02, B99171-02, B99173-02, 22x6 mm

-02 = Galvanized steel

R = Right opening  
L = Left opening

PU = 1 piece

**Riscontro centrale**

Riscontro centrale per serratura a 3 punti di chiusura B99170-02, B99171-02, B99173-02, 22x6 mm

-02 = Acciaio zincato

R = Apertura destra  
L = Apertura sinistra

UV = 1 pezzo

**Chapa de cierre central**

Chapa de cierre central para bloqueo de 3 puntos B99170-02, B99171-02, B99173-02, 22x6 mm

-02 = Acero galvanizado

R = Apertura derecha  
L = Apertura izquierda

CANTIDAD = 1 unidad



B99203-02 R  
B99204-02 L

**Strike plate**

Upper and lower strike plate for B99170-02, B99171-02, B99173-02 locks and B99169-02 extension, 22x6 mm

-02 = Galvanized steel

PU = 1 piece

**Riscontro**

Riscontro superiore e inferiore per serratura B99170-02, B99171-02, B99173-02 e prolunga B99169-02, 22x6 mm

-02 = Acciaio zincato

UV = 1 pezzo

**Chapa de cierre**

Chapa de cierre superior y inferior para cerraduras B99170-02, B99171-02, B99173-02 y extensión B99169-02, 22x6 mm

-02 = Acero galvanizado

CANTIDAD = 1 unidad



B99205-02

**Central strike plate**

Central strike plate for mortise lock device B99111-02, 25x3 mm

-02 = Galvanized steel

PU = 1 piece

**Riscontro centrale**

Riscontro centrale per serratura B99111-02, 25x3 mm

-02 = Acciaio zincato

UV = 1 pezzo

**Chapa de cierre central**

Chapa de cierre central para cerradura B99111-02, 25x3 mm

-02 = Acero galvanizado

CANTIDAD = 1 unidad



B99206-02

**Central strike plate**

Central strike plate for mortise lock device B99015-02, 24x6 mm

-04 = Satin stainless steel AISI 304

PU = 1 piece

**Riscontro centrale**

Riscontro centrale per serratura B99015-02, 24x6 mm

-04 = Acciaio inox AISI 304 satinato

UV = 1 pezzo

**Chapa de cierre central**

Chapa de cierre central para cerradura B99015-02, 24x6 mm

-04 = Acero inoxidable AISI 304 satinado

CANTIDAD = 1 unidad



B99207-04

**Central strike plate**

Central strike plate for mortise lock device B99174-02 and B99175-02, 22x6 mm

-02 = Galvanized steel

R = Right opening  
L = Left opening

PU = 1 piece

**Riscontro centrale**

Riscontro centrale per serratura B99174-02 e B99175-02, 22x6 mm

-02 = Acciaio zincato

R = Apertura destra  
L = Apertura sinistra

UV = 1 pezzo

**Chapa de cierre central**

Chapa de cierre central para cerradura B99174-02 y B99175-02, 22x6 mm

-02 = Acero galvanizado

R = Apertura derecha  
L = Apertura izquierda

CANTIDAD = 1 unidad



B99209-02 R  
B99210-02 L

**Plate**

Stainless steel cut out covering for flush profiles system.

-04 = Satin stainless steel AISI 304

PU = 4 pieces

**Piastra**

Stampato finitura fresate in acciaio inox per sistema profili coplanari.

-04 = Acciaio Inox AISI 304 satinato

UV = 4 pezzi

**Plato**

Plato en acero inoxidable para fresadora de sistema perfiles coplanarios.

-04 = Acero inoxidable AISI 304 satinado

CANTIDAD = 4 unidades

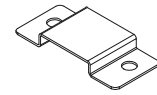

E99134-04

**Plate**

Only for double leaf door with B99111-02 lock + E9902X-35 flush bolt.

-03 = Stainless steel AISI 304 2B

PU = 2 pieces

**Piastra**

Solo per porta a due ante con serratura B99111-02 + catenaccio E9902X-35

-03 = Acciaio inossidabile AISI 304 2B

UV = 2 pezzi

**Plato**

Solo para puerta de dos hojas con cerradura B99111-02 + pasador de canto E9902X-35

-03 = Acero inoxidable AISI 304 2B

CANTIDAD = 2 unidades

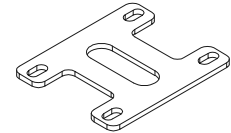

E99015-03

**Lock extension**

Extension for multi-point lock B99174-02 and B99175-02, stainless steel faceplate 24x6 mm; without pawls.

-02 = Galvanized steel

PU = 1 piece

**Prolunga serratura**

Prolunga per serratura multipunto B99174-02 e B99175-02, frontale in acciaio inox 24x6 mm; senza nottolini.

-02 = Acciaio zincato

UV = 1 pezzo

**Extensión de bloqueo**

Prolongación para cerradura multipunto B99174-02 y B99175-02, frontal en acero inoxidable 24x6 mm; sin trinquetes.

-02 = Acero galvanizado

CANTIDAD = 1 unidad

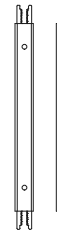

B99156-02

**Lock extension**

Extension for multi-point lock B99174-02 and B99175-02, stainless steel faceplate 24x6 mm, n°2 studs.

-02 = Galvanized steel

PU = 1 piece

**Prolunga serratura**

Prolunga per serratura multipunto B99174-02 e B99175-02, frontale in acciaio inox 24x6 mm, n°2 nottolini.

-02 = Acciaio zincato

UV = 1 pezzo

**Extensión de bloqueo**

Prolongación para cerradura multipunto B99174-02 y B99175-02, frontal en acero inoxidable 24x6 mm, n°2 alfileres.

-02 = Acero galvanizado

CANTIDAD = 1 unidad



B99157-02

**Rebate protection for latchbolt**

Rebate protection for latchbolt, for open in and open out door, 60x17.8x0.8 mm

-04 = Satin stainless steel AISI 304

PU = 1 piece

**Protezione battuta per scrocco**

Protezione battuta per scrocco, per porta apertura interna ed esterna, 60x17.8x0.8 mm

-04 = Acciaio Inox AISI 304 satinato

UV = 1 pezzo

**Protección de parada para pestillo**

Protección de parada para pestillo, para puerta que se abre hacia dentro y fuera, 60x17.8x0.8 mm

-04 = Acero inoxidable AISI 304 satinado

CANTIDAD = 1 unidad



D99157-04



**Screws**

**Viti**

**Tornillos**

**3.7**

**Screw**

Hexagon recessed countersunk screw  
stainless steel A2 M4x10 mm  
DIN7991 / ISO10642

PU = 100 pieces

**Vite**

Vite testa svasata piana esagono incassato,  
acciaio inox A2 M4x10 mm  
DIN7991 / ISO10642

UV = 100 pezzi

**Tornillo**

Tornillo cabeza plana avellanada con hexágono interior,  
acero inoxidable A2 M4x10 mm  
DIN7991 / ISO10642

CANTIDAD = 100 unidades



D99880-03

**Screw**

Hexagon recessed cap head screw  
stainless steel A2 M4x10 mm  
DIN912 / ISO4762

PU = 100 pieces

**Vite**

Vite testa cilindrica esagono incassato,  
acciaio inox A2 M4x10 mm  
DIN912 / ISO4762

UV = 100 pezzi

**Tornillo**

Tornillo cilindrico con hexágono interior, acero inoxidable A2  
M4x10 mm  
DIN912 / ISO4762

CANTIDAD = 100 unidades



D99882-03

**Screw**

Cross recessed countersunk head screw, M4x8 mm  
DIN7982 / ISO7050

-02 = Galvanized steel  
-03 = Stainless steel A2

PU = 100 pieces

**Vite**

Vite testa svasata intaglio a croce, M4x8 mm  
DIN7982 / ISO7050

-02 = Acciaio zincato  
-03 = Acciaio inox A2

UV = 100 pezzi

**Tornillo**

Tornillo avellanado y de chapa con ranura en cruz, M4x8 mm  
DIN7982 / ISO7050

-02 = Acero galvanizado  
-03 = Acero inoxidable A2

CANTIDAD = 100 unidades



D99980-nn

**Screw**

Hexagon recessed countersunk screw  
stainless steel A2 M4x6 mm  
DIN7991 / ISO10642

PU = 100 pieces

**Vite**

Vite testa svasata piana esagono incassato,  
acciaio inox A2 M4x6 mm  
DIN7991 / ISO10642

UV = 100 pezzi

**Tornillo**

Tornillo cabeza plana avellanada con hexágono interior,  
acero inoxidable A2 M4x6 mm  
DIN7991 / ISO10642

CANTIDAD = 100 unidades



D99867-03

**Screw**

Hexagon recessed cap head screw  
stainless steel A2 M4x6 mm  
DIN912 / ISO4762

PU = 100 pieces

**Vite**

Vite testa cilindrica esagono incassato,  
acciaio inox A2 M4x6 mm  
DIN912 / ISO4762

UV = 100 pezzi

**Tornillo**

Tornillo cilindrico con hexágono interior, acero inoxidable A2  
M4x6 mm  
DIN912 / ISO4762

CANTIDAD = 100 unidades



D99866-03

**Screw**

Cross recessed countersunk head screw, stainless steel A2 Ø4.2x9.5 mm  
DIN 7982 / ISO 7050

PU = 100 pieces

**Vite**

Vite testa svasata intaglio a croce, acciaio inox A2 Ø4.2x9.5 mm  
DIN 7982 / ISO 7050

UV = 100 pezzi

**Tornillo**

Tornillo avellanado y de chapa con ranura en cruz, acero inoxidable A2  
Ø4.2x9.5 mm  
DIN 7982 / ISO 7050

CANTIDAD = 100 unidades



D99815-03

**Note:**

All uncoded screws are the responsibility of the customer.

**Nota:**

Tutte le viti non codificate sono a carico del cliente.

**Nota:**

Todos los tornillos no codificados son responsabilidad del cliente.

**Screw**

Cross recessed pan head screw, stainless steel A2 Ø3.5x6.5 mm DIN 7981 / ISO 7049

PU = 100 pieces

**Vite**

Vite testa bombata intaglio croce, acciaio inox A2 Ø3.5x6.5 mm DIN 7981 / ISO 7049

UV = 100 pezzi

**Tornillo**

Tornillo alomado y de chapa con ranura en cruz, acero inoxidable A2 Ø3.5x6.5 mm DIN 7981 / ISO 7049

CANTIDAD = 100 unidades



D99801-03

**Rivet**

Button-head rivet, stainless steel A2 Ø3.2x8 mm DIN7337 / ISO15973

PU = 100 pieces

**Rivetto**

Rivetto testa tonda acciaio inox A2 Ø3.2x8 mm DIN7337 / ISO15973

UV = 100 pezzi

**Remache**

Remache semiesférico, acero inoxidable A2 Ø3.2x8 mm DIN7337 / ISO15973

CANTIDAD = 100 unidades



D99950-03

**Bushing**

M5 brass bushing.

PU = 20 pieces

**Boccola**

Boccola in ottone M5.

UV = 20 pezzi

**Casquillo**

Casquillo en latón M5.

CANTIDAD = 20 unidades

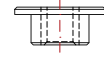

D99702-08

**Bushing**

M4 brass bushing.

PU = 20 pieces

**Boccola**

Boccola in ottone M4.

UV = 20 pezzi

**Casquillo**

Casquillo en latón M4.

CANTIDAD = 20 unidades

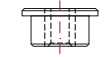

D99704-08

**Bushing**

M5 stainless steel bushing.

PU = 20 pieces

**Boccola**

Boccola in acciaio inox M5.

UV = 20 pezzi

**Casquillo**

Casquillo en acero inoxidable M5.

CANTIDAD = 20 unidades

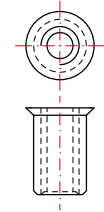

D99705-03

**Bonding**

Adhesive for rebate gaskets.

PU = 1 piece

**Adesivo**

Adesivo per guarnizione di battuta.

UV = 1 pezzo

**Pegamento**

Pegamento para juntas de encaje.

CANTIDAD = 1 unidad

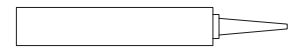

OS 364991

**Primer**

Primer for double adhesive tape, powder coating

PU = 1 piece

**Primer**

Primer per nastro biadesivo, verniciatura a polveri

UV = 1 pezzo

**Primer**

Primer para cinta de doble cara, recubrimiento en polvo

CANTIDAD = 1 unidad



199005-75

**Note:**

All uncoded screws are the responsibility of the customer.

**Nota:**

Tutte le viti non codificate sono a carico del cliente.

**Nota:**

Todos los tornillos no codificados son responsabilidad del cliente.





**Assembling tools**

**Utensili di assemblaggio**

**Herramientas de montaje**

**3.8**



**Alignment pin**

For welding of hinge  
C99008-nn

PU = 1 piece

**Spina di allineamento**

Per saldatura cerniera  
C99008-nn

UV = 1 pezzo

**Pasador de posicionamiento**

Pasador de posicionamiento para  
soldadura de bisagra C99008-nn

CANTIDAD = 1 unidad

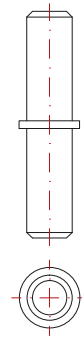

D99401-31

**Adjusting tool**

Adjusting tool for 3D hinge  
C99008-nn

PU = 1 piece

**Chiave di regolazione**

Chiave di regolazione per cerniera  
3D C99008-nn

UV = 1 pezzo

**Llave**

Llave de ajuste para calibrar  
bisagras 3D C99008-nn

CANTIDAD = 1 unidad

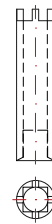

D99501-31

**Alignment pin**

For welding of hinge  
C99009-nn

PU = 1 piece

**Spina di allineamento**

Per saldatura cerniera  
C99009-nn

UV = 1 pezzo

**Pasador de posicionamiento**

Pasador de posicionamiento para  
soldadura de bisagra C99009-nn

CANTIDAD = 1 unidad

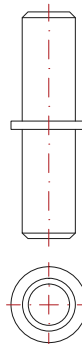

D99402-31

**Adjusting tool**

Adjusting tool for 3D hinge  
C99009-nn

PU = 1 piece

**Chiave di regolazione**

Chiave di regolazione per cerniera  
3D C99009-nn

UV = 1 pezzo

**Llave**

Llave de ajuste para calibrar  
bisagras 3D C99009-nn

CANTIDAD = 1 unidad

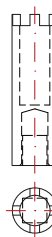

D99502-31

**Scissors**

Seal-cutting scissor,  
15°, 30°, 45°, 90° cutting angle.

PU = 1 piece

**Forbici**

Forbici per guarnizioni,  
taglio 15°, 30°, 45°, 90°.

UV = 1 pezzo

**Cizallas**

Cizalla para juntas,  
corte de 15°, 30°, 45°, 90°.

CANTIDAD = 1 unidad

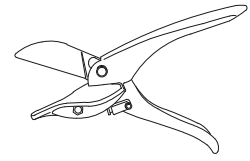

D99540-02

**Scissors  
Spare parts**

Blades for scissor D99540-02

PU = 1 pair

**Forbici  
Pezzi di ricambio**

Lame per forbici D99540-02

UV = 1 coppia

**Cizallas  
Piezas de repuesto**

Cuchillas por cizalla D99540-02

CANTIDAD = 1 par



Q99540C-99

**Scissors**

Seal-cutting scissor,  
45° cutting angle.

PU = 1 piece

**Forbici**

Forbici per guarnizioni,  
taglio 45°.

UV = 1 pezzo

**Cizallas**

Cizalla para juntas,  
corte de 45°.

CANTIDAD = 1 unidad

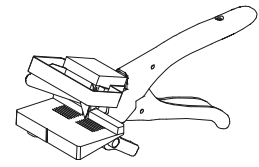

D99543-02

**Scissors  
Spare parts**

Base for scissor D99543-02

PU = 1 piece

**Forbici  
Pezzi di ricambio**

Base per forbici D99543-02

UV = 1 pezzo

**Cizallas  
Piezas de repuesto**

Soporte por cizalla D99543-02

CANTIDAD = 1 unidad

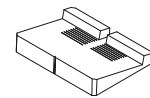

Q99543A-99

**Scissors  
Spare parts**

Blades retainer with blades and  
safety bracket for scissor  
D99543-02

PU = 1 piece

**Forbici  
Pezzi di ricambio**

Porta lame con lame e protezione  
per forbici D99543-02

UV = 1 pezzo

**Cizallas  
Piezas de repuesto**

Portacuchillas completo con cuchillas  
por cizalla D99543-02

CANTIDAD = 1 unidad

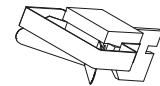

Q99543B-99

**Scissors  
Spare parts**

Blades for scissor D99543-02

PU = 4 pieces

**Forbici  
Pezzi di ricambio**

Lame per forbici D99543-02

UV = 4 pezzi

**Cizallas  
Piezas de repuesto**

Cuchillas por cizalla D99543-02

CANTIDAD = 4 unidades

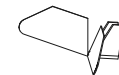

Q99543C-99

**Scissors  
Spare parts**

Locking lever for scissor  
D99543-02

PU = 1 pair

**Forbici  
Pezzi di ricambio**

Leva di bloccaggio per forbici  
D99543-02

UV = 1 coppia

**Cizallas  
Piezas de repuesto**

Palanca de bloqueo por cizalla  
D99543-02

CANTIDAD = 1 par

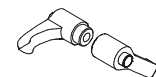

Q99543D-99

**Cutting templates**

Aluminum, supports for cutting profiles, length 300 mm

PU = 1 piece

**Dime di taglio**

Alluminio, per il taglio dei profili, lunghezza 300 mm

UV = 1 pezzo

**Plantilla de corte**

Aluminio, base para serrar los perfiles, longitud de 300 mm

CANTIDAD = 1 unidad

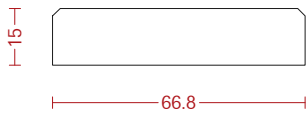

D99418-00

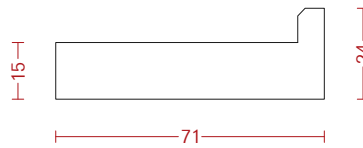

D99419-00

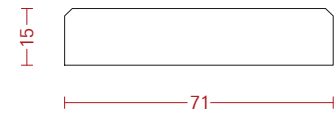

D99420-00

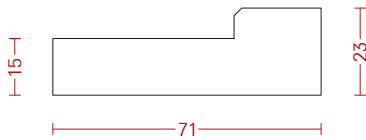

D99421-00

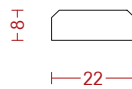

D99422-00

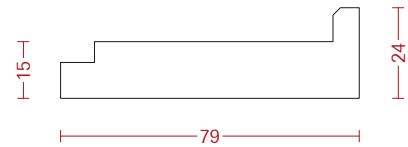

D99423-00

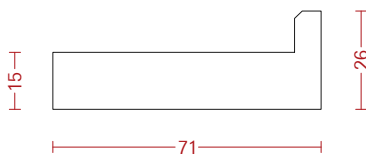

D99424-00

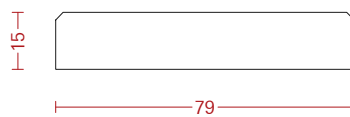

D99425-00

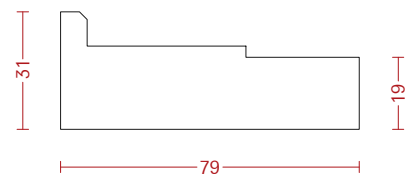

D99426-00

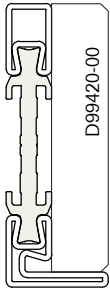

FT 7512L-nn

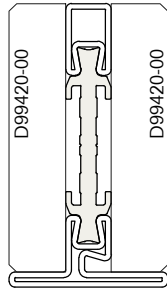

FT 7512T-nn

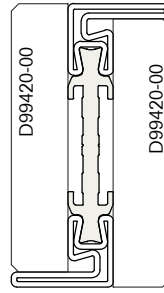

FT 7512Z-nn

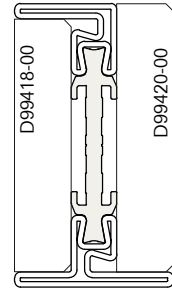

FT 7512H-nn

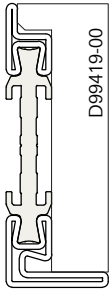

FT 7512LK-nn

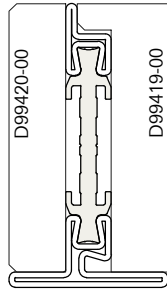

FT 7512TK-nn

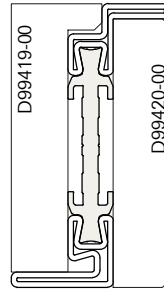

FT 7512ZK-nn

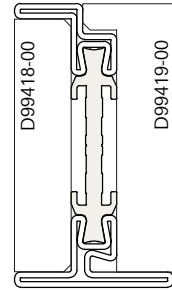

FT 7512HK-nn

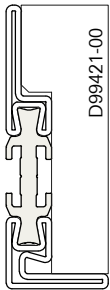

FT 7512LR-nn

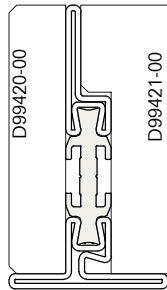

FT 7512TR-nn

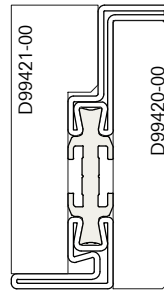

FT 7512ZR-nn

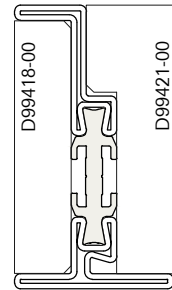

FT 7512HR-nn

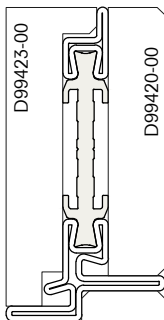

FT 8312TZ-nn

D99422-00 \*

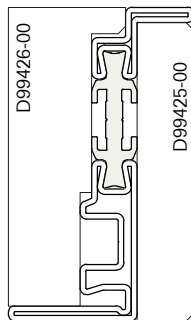

FT 8312ZR-nn

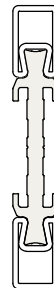

FT 7512PU-nn

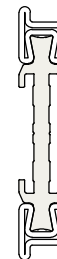

FT 6712LB-nn

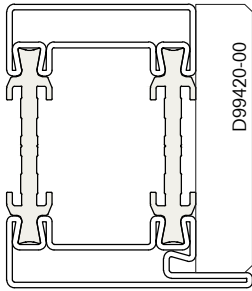

FT 7550LF-nn

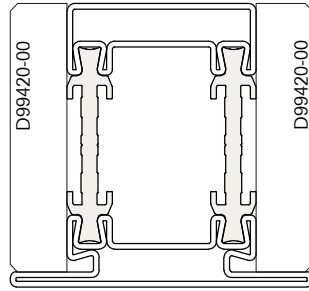

FT 7550TF-nn

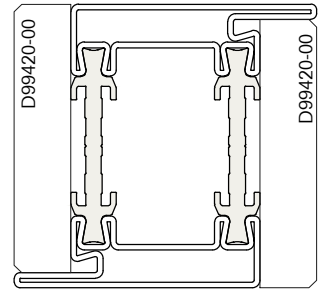

FT 7550ZF-nn

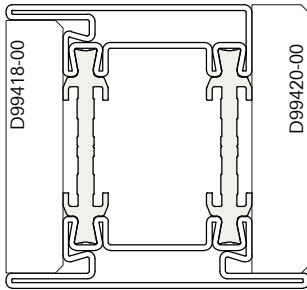

FT 7550HF-nn

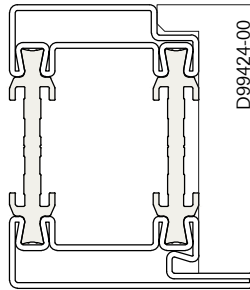

FT 7550L-nn

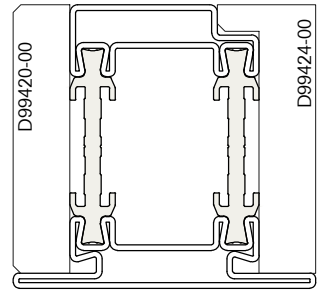

FT 7550T-nn

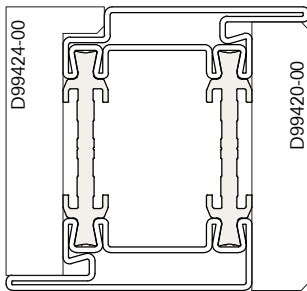

FT 7550Z-nn

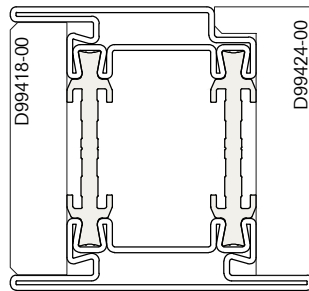

FT 7550H-nn

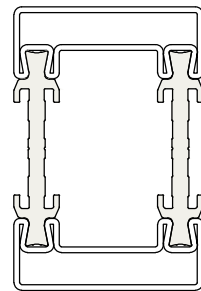

FT 755PU-nn



**Profile cutting**

**Taglio dei profili**

**Corte de Perfil**

Top cut
Taglio dall'alto
Corte vertical

Side cut
Taglio dal lato
Corte horizontal

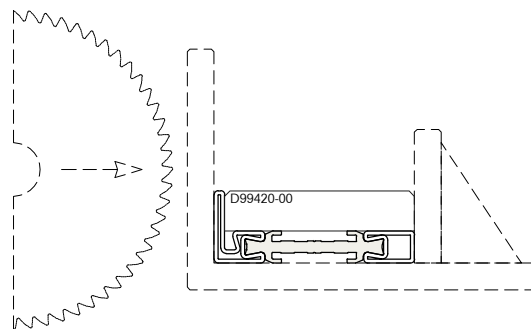
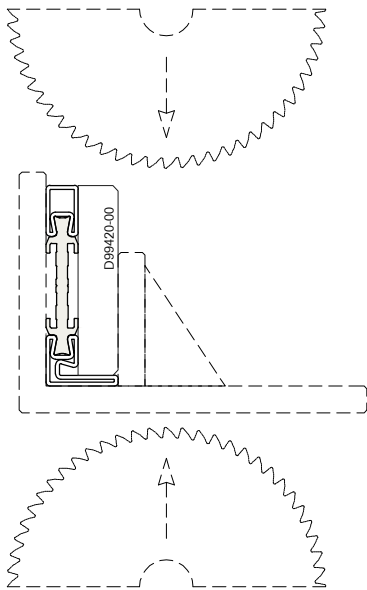

**Templates for weld-on hinges C99008-nn**

See installation page [5.4.56](#)

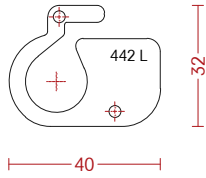

D99442-03  
Flush profiles  
Profili complanari  
Perfiles coplanarios

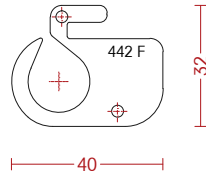

**Dime per cerniere a saldare C99008-nn**

**Plantilla para bisagra de soldadura C99008-nn**

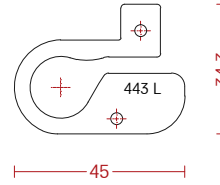

D99443-03  
Overlapped profiles  
Profili a sormonto  
Perfiles superpuestos

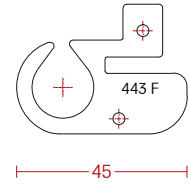

**Templates for weld-on hinges C99009-nn**

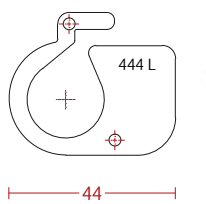

D99444-03  
Flush profiles  
Profili complanari  
Perfiles coplanarios

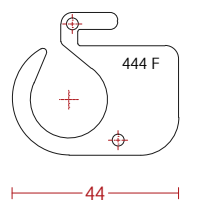

**Dime per cerniere a saldare C99009-nn**

**Plantilla para bisagra de soldadura C99009-nn**

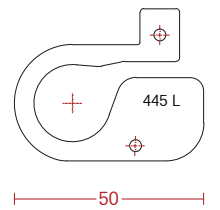

D99445-03  
Overlapped profiles  
Profili a sormonto  
Perfiles superpuestos

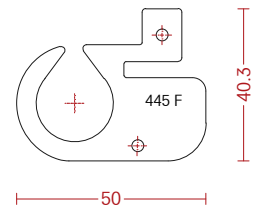

**Templates for weld-on hinges**

D75 TB - Door profiles

**Dime per cerniere a saldare**

D75 TB - Profili porta

**Plantilla para bisagra de soldadura**

D75 TB - Perfiles puertas

**C99009-nn**

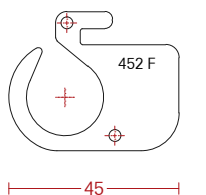

D99452-03  
Flush profiles  
Profili complanari  
Perfiles coplanarios

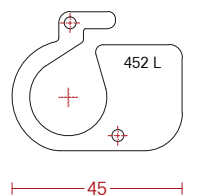

**C99008-nn**

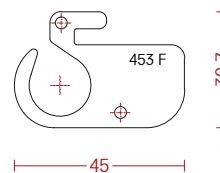

D99453-03  
Overlapped profiles  
Profili a sormonto  
Perfiles superpuestos

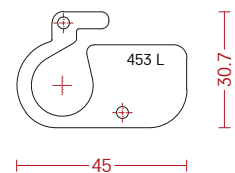

**Templates for  
Tilt&Turn fittings**

**Dime per ferramenta  
anta ribalta**

**Plantilla para herrajes  
para ventana oscilante**

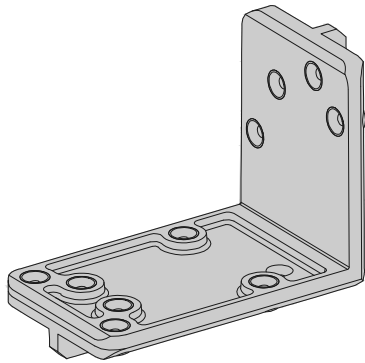

MC 217092

See installation page [5.8.123](#)

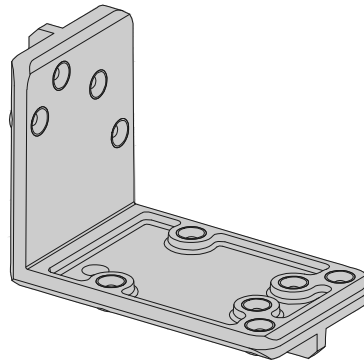

MC 217093

See installation page [5.8.123](#)

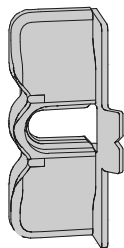

MC 229643

See installation page [5.8.123](#)

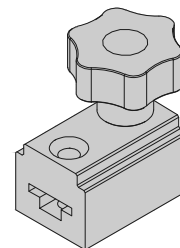

MC 463153

See installation page [5.8.109](#)



**Multipoint  
steel rods,  
with Graz**

**Multipoint  
aste in acciaio,  
con Graz**

**Multipoint  
varillas de acero,  
con Graz**

**3.9**

**Multipoint steel rods parts, with Graz**  
Open in  
Right and left opening

**Multipoint aste in acciaio componenti, con Graz**  
Apertura interna  
Apertura destra e sinistra

**Multipoint varillas de acero componentes, con Graz**  
Que se abre hacia dentro  
Apertura derecha y izquierda

**Short rod**

**Asta corta**

**Varilla corta**



E99379-03

**Long rod**

**Asta lunga**

**Varilla largo**



E99378-03

**Locking set**

E99134-04 - Cutout cover  
Q99182-11 - Strike plate  
D99702-08 - n°04 M5 brass bushing  
D99706-08 - n°02 collars

**Punto di chiusura**

E99134-04 - Copertura fresata  
Q99182-11 - Riscocontro  
D99702-08 - n°04 boccole in ottone M5  
D99706-08 - n°02 collari

**Punto de cierre**

E99134-04 - Cubierta molida  
Q99182-11 - Chapa de cierre  
D99702-08 - n°04 casquillo en latón M5  
D99706-08 - n°02 collares

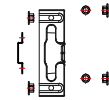

**Additional locking set**

E99134-04 - Cutout cover  
Q99182-11 - Strike plate  
D99702-08 - n°02 M5 brass bushing  
E99353-03 - Single additional point

**Punto aggiuntivo**

E99134-04 - Copertura fresata  
Q99182-11 - Riscocontro  
D99702-08 - n°02 boccole in ottone M5  
E99353-03 - Punto singolo addizionale

**Punto adicional**

E99134-04 - Cubierta molida  
Q99182-11 - Chapa de cierre  
D99702-08 - n°02 casquillo en latón M5  
E99353-03 - Punto único adicional

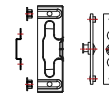

**Drive block**

**Blocco guida**

**Bloque de guía**

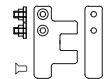

K99100

**Cremone gear Graz**

E99652-03 (Left opening)  
E99653-03 (Right opening)

[See configuration page.](#)

**Graz**

E99652-03 (Apertura sinistra)  
E99653-03 (Apertura destra)

[Vedi pagina configurazione.](#)

**Graz**

E99652-03 (Apertura izquierda)  
E99653-03 (Apertura derecha)

[Ver página del configurador.](#)

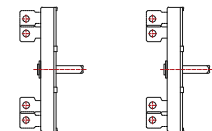

E9965X-03

**Note:**

For handle selection, consult the handles catalog.

**Note:**

Per scelta maniglia consultare il catalogo maniglie.

**Nota:**

Para la selección de manillas consultar el catálogo de manillas.

**Multipoint steel rods parts, with Graz**  
Open out  
Right and left opening

**Multipoint aste in acciaio componenti, con Graz**  
Apertura esterna  
Apertura destra e sinistra

**Multipoint varillas de acero componentes, con Graz**  
Que se abre hacia fuera  
Apertura derecha y izquierda

**Short rod**

**Asta corta**

**Varilla corta**



E99379-03

**Long rod**

**Asta lunga**

**Varilla largo**



E99378-03

**Locking set**

E99134-04 - Cutout cover  
Q99182-11 - Strike plate  
D99702-08 - n°04 M5 brass bushing  
D99706-08 - n°02 collars

**Punto di chiusura**

E99134-04 - Copertura fresata  
Q99182-11 - Riscontro  
D99702-08 - n°04 boccole in ottone M5  
D99706-08 - n°02 collari

**Punto de cierre**

E99134-04 - Cubierta molida  
Q99182-11 - Chapa de cierre  
D99702-08 - n°04 casquillo en latón M5  
D99706-08 - n°02 collares

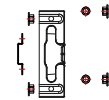

**Additional locking set**

E99134-04 - Cutout cover  
Q99182-11 - Strike plate  
D99702-08 - n°02 M5 brass bushing  
E99353-03 - Single additional point

**Punto aggiuntivo**

E99134-04 - Copertura fresata  
Q99182-11 - Riscontro  
D99702-08 - n°02 boccole in ottone M5  
E99353-03 - Punto singolo addizionale

**Punto adicional**

E99134-04 - Cubierta molida  
Q99182-11 - Chapa de cierre  
D99702-08 - n°02 casquillo en latón M5  
E99353-03 - Punto único adicional

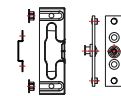

**Drive block**

**Blocco guida**

**Bloque de guía**

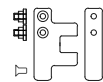

K99100

**Cremone gear Graz**

E99652-03 (Left opening)  
E99653-03 (Right opening)

[See configuration page.](#)

**Graz**

E99652-03 (Apertura sinistra)  
E99653-03 (Apertura destra)

[Vedi pagina configurazione.](#)

**Graz**

E99652-03 (Apertura izquierda)  
E99653-03 (Apertura derecha)

[Ver página del configurador.](#)

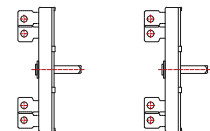

E9965X-03

**Handle for 1st leaf**

-06 = Stainless steel AISI 316L  
-12 = Bright steel

**Maniglia per 1a anta**

-06 = Acciaio inox AISI 316L  
-12 = Acciaio decapato

**Manija para 1er hoja**

-06 = Acero inoxidable AISI 316L  
-12 = Acero bruto



H99020-nn

**Note:**

Consult the handles catalog available for the Graz.

**Note:**

Consultare il catalogo maniglie disponibili per il Graz.

**Nota:**

Consulta el catálogo de manija disponibles para el Graz.





**Multipoint  
aluminum rods,  
with Graz and Mono**

**Multipoint  
aste in alluminio,  
con Graz e Mono**

**Multipoint  
varillas de aluminio,  
con Graz y Mono**

**3.10**

**Multipoint aluminum rods parts,  
with Graz and Mono**

Open in  
Right and left opening

**Multipoint aste in alluminio  
componenti, con Graz e Mono**

Apertura interna  
Apertura destra e sinistra

**Multipoint varillas de aluminio  
componentes, con Graz y Mono**

Que se abre hacia dentro  
Apertura derecha y izquierda

Rod

Asta

Varilla



E99383-53

Cremone gear connection

Connettore

Conector

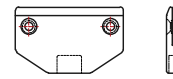

E99391-87

Strike plate

Riscontro

Chapa de cierre



E99389-11

Stud

Nottolino

Alfiler

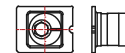

E99397-03

**Note:**

For handle selection, consult the handles catalog.

**Note:**

Per scelta maniglia consultare il catalogo maniglie.

**Nota:**

Para la selección de manillas consultar el catálogo de manillas.

**Kit for shoot bolt**

QK99108B-02 - Strike plate  
QD99713A-02 - n°02 M4 bushing  
QK99108A-02 - Shoot bolt

**Kit puntale**

QK99108B-02 - Riscontro  
QD99713A-02 - n°02 boccole M4  
QK99108A-02 - Puntale

**Kit para cerrojo**

QK99108B-02 - Chapa de cierre  
QD99713A-02 - n°02 casquillo M4  
QK99108A-02 - Consejo

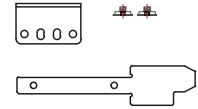

K99108

**Cremone gear Graz**

E99652-03 (Left opening)  
E99653-03 (Right opening)

[See configuration page.](#)

**Graz**

E99652-03 (Apertura sinistra)  
E99653-03 (Apertura destra)

[Vedi pagina configurazione.](#)

**Graz**

E99652-03 (Apertura izquierda)  
E99653-03 (Apertura derecha)

[Ver página del configurador.](#)

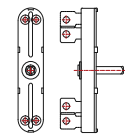

E9965X-03

**Cremone gear Mono**

**Mono**

**Mono**

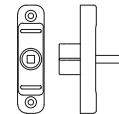

E99658-11

**Note:**

For handle selection, consult the handles catalog.

**Note:**

Per scelta maniglia consultare il catalogo maniglie.

**Nota:**

Para la selección de manillas consultar el catálogo de manillas.

**Multipoint aluminum rods parts,  
with Graz and Mono**

Open out  
Right and left opening

**Multipoint aste in alluminio  
componenti, con Graz e Mono**

Apertura esterna  
Apertura destra e sinistra

**Multipoint varillas de aluminio  
componentes, con Graz y Mono**

Que se abre hacia fuera  
Apertura derecha y izquierda

Rod

Asta

Varilla



E99383-53

Cremone gear connection

Connettore

Conector

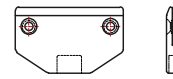

E99391-87

Strike plate

Riscontro

Chapa de cierre



E99389-11

Stud

Nottolino

Alfiler

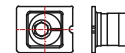

E99397-03

Coutout cover

Copertura fresata

Cubierta molida

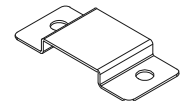

E99134-04

**Note:**

For handle selection, consult the handles catalog.

**Note:**

Per scelta maniglia consultare il catalogo maniglie.

**Nota:**

Para la selección de manillas consultar el catálogo de manillas.

### Kit for shoot bolt

QK99108B-02 - Strike plate  
QD99713A-02 - n°02 M4 bushing  
QK99108A-02 - Shoot bolt

### Kit puntale

QK99108B-02 - Riscontro  
QD99713A-02 - n°02 boccole M4  
QK99108A-02 - Puntale

### Kit para cerrojo

QK99108B-02 - Chapa de cierre  
QD99713A-02 - n°02 casquillo M4  
QK99108A-02 - Consejo

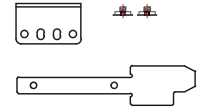

K99108

### Cremone gear Graz

E99652-03 (Left opening)  
E99653-03 (Right opening)

[See configuration page.](#)

### Graz

E99652-03 (Apertura sinistra)  
E99653-03 (Apertura destra)

[Vedi pagina configurazione.](#)

### Graz

E99652-03 (Apertura izquierda)  
E99653-03 (Apertura derecha)

[Ver página del configurador.](#)

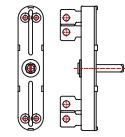

E9965X-03

### Cremone gear Mono

### Mono

### Mono

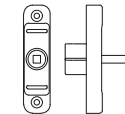

E99658-11

### Handle for 1st leaf

-06 = Stainless steel AISI 316L  
-12 = Bright steel

### Maniglia per 1a anta

-06 = Acciaio inox AISI 316L  
-12 = Acciaio decapato

### Manija para 1er hoja

-06 = Acero inoxidable AISI 316L  
-12 = Acero bruto

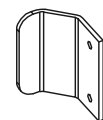

H99020-nn

#### Note:

For handle selection, consult the handles catalog.

#### Note:

Per scelta maniglia consultare il catalogo maniglie.

#### Nota:

Para la selección de manillas consultar el catálogo de manillas.



**Multipoint aluminum rods  
parts, with lever handle**

**Multipoint aste in  
alluminio componenti,  
con cariglione**

**Multipoint varillas de  
aluminio componentes,  
con manija de bloqueo**

**3.11**

**Multipoint aluminum rods parts, with lever handle**  
Right and left opening

**Multipoint aste in alluminio componenti, con cariglione**  
Apertura destra e sinistra

**Multipoint varillas de aluminio componentes, con manija de bloqueo**  
Apertura derecha y izquierda

**Rod**

**Asta**

**Varilla**



E99383-53

**Cremone gear connection**

**Connettore**

**Conector**

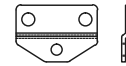

E99398-02

**Strike plate**

**Riscontro**

**Chapa de cierre**



E99389-11

**Stud**

**Nottolino**

**Alfiler**



E99397-03

**Bush**

**Boccola**

**Casquillo**



D99714-02



### Kit for shoot bolt

QK99108B-02 - Strike plate  
QD99713A-02 - n°02 M4 bushing  
QK99108A-02 - Shoot bolt

### Kit puntale

QK99108B-02 - Riscontro  
QD99713A-02 - n°02 boccole M4  
QK99108A-02 - Puntale

### Kit para cerrojo

QK99108B-02 - Chapa de cierre  
QD99713A-02 - n°02 casquillo M4  
QK99108A-02 - Consejo

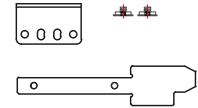

K99108

### Lever handle

Lever handle with concealed connecting rods, front installation.

Finishings:

18 20 23 24 28 29 43

PU = 1 piece

### Cariglione

Maniglia a leva, fissaggio frontale.

Finiture:

18 20 23 24 28 29 43

UV = 1 pezzo

### Manija de bloqueo

Palanca con barras de empuje ocultas, fijación frontal.

Acabados:

18 20 23 24 28 29 43

CANTIDAD = 1 unidad

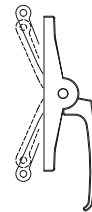

H99001-nn

### Lever handle lockable

Lever handle with concealed connecting rods, front installation, lockable with key.

Finishings:

18 20 23 24 28 29 43

PU = 1 piece

### Cariglione con chiave

Maniglia a leva, fissaggio frontale, con chiusura a chiave.

Finiture:

18 20 23 24 28 29 43

UV = 1 pezzo

### Manija de bloqueo bloqueable

Palanca con barras de empuje ocultas, fijación frontal, bloqueable con llave.

Acabados:

18 20 23 24 28 29 43

CANTIDAD = 1 unidad

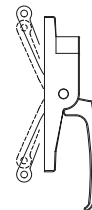

H99003-nn

### Handle for 1st leaf

For open out windows.

-06 = Stainless steel AISI 316L  
-12 = Bright steel

### Maniglia per 1a anta

Per finestra apertura esterna.

-06 = Acciaio inox AISI 316L  
-12 = Acciaio decapato

### Manija para 1er hoja

Para ventana que se abre hacia fuera.

-06 = Acero inoxidable AISI 316L  
-12 = Acero bruto

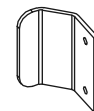

H99020-nn



**Tilt&Turn window**

**Finestra anta ribalta**

**Ventana oscilante**

**3.12**

**Stabilising scissor stay**

Stabilising scissor stay case Euro-channel 18 mm, silver.

PU = 1 piece

**Scontro per forcice supplementare**

Scontro per forcice supplementare battuta liscia 18 mm, argento.

UV = 1 pezzo

**Cerradero compás adicional**

Cerradero compás adicional base 18 mm, plata.

CANTIDAD = 1 unidad



MC 52794

**Turn restrictor**

Turn restrictor Euro-channel L=187 mm, silver.

PU = 1 piece

**Delimitatore d'apertura**

Delimitatore d'apertura battuta liscia L=187 mm, argento.

UV = 1 pezzo

**Delimitador de apertura**

Delimitador de apertura base lisa L=187 mm, plata.

CANTIDAD = 1 unidad



MC 103623

**Load transfer**

Load transfer for FT 24 mm R, silver.

R = Right opening

PU = 1 piece

**Asta di sostegno**

Asta di sostegno per PB 24 mm R, argento.

R = Apertura destra

UV = 1 pezzo

**Varilla de soporte**

Varilla de soporte para FT 24 mm R, plata.

R = Apertura derecha

CANTIDAD = 1 unidad

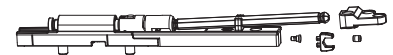

MC 105336

**Load transfer**

Load transfer for FT 24 mm L, silver.

L = Left opening

PU = 1 piece

**Asta di sostegno**

Asta di sostegno per PB 24 mm L, argento.

L = Apertura sinistra

UV = 1 pezzo

**Varilla de soporte**

Varilla de soporte para FT 24 mm L, plata.

L = Apertura izquierda

CANTIDAD = 1 unidad



MC 105339

### Adaptor

Adaptor with contact sensor KVS, grey.

PU = 1 piece

### Nottolino magnetico

Nottolino magnetico a clips, grigio.

UV = 1 pezzo

### Adaptador

Adaptador con bulón magnético KVS, gris.

CANTIDAD = 1 unidad

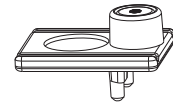

MC 200906

### Faceplate extension

Faceplate extension, extendable 235 mm with 1 i.S., silver.

PU = 1 piece

### Prolunga frontale

Prolunga frontale prolungabile 235 mm con 1 fungo, argento.

UV = 1 pezzo

### Prolongador frontal

Prolongador frontal prolongable 235 mm con 1 bulón i.S., plata.

CANTIDAD = 1 unidad



MC 201750

### Centre lock

Centre lock 1280 mm with 1 i.S. HBB/LBB 801-1280 mm, silver.

PU = 1 piece

### Chiusura centrale

Chiusura centrale 1280 mm con 1 fungo HBB/LBB 801-1280 mm, argento.

UV = 1 pezzo

### Cierre central

Cierre central 1280 mm con 1 bulón i.S. HBB/LBB 801-1280 mm, plata.

CANTIDAD = 1 unidad



MC 201751

### Centre lock

Centre lock 1500 mm with 1 i.S. HBB/LBB 1281-1500 mm, silver.

PU = 1 piece

### Chiusura centrale

Chiusura centrale 1500 mm con 1 fungo HBB/LBB 1281-1500 mm, argento.

UV = 1 pezzo

### Cierre central

Cierre central 1500 mm con 1 bulón i.S. HBB/LBB 1281-1500 mm, plata.

CANTIDAD = 1 unidad



MC 201752

**Centre lock**

Centre lock extendable 1500V with 1 i.S. HBB/LBB 1281-1500 mm, silver.

PU = 1 piece

**Chiusura centrale**

Chiusura centrale prolungabile 1500V con 1 fungo HBB/LBB 1281-1500 mm, argento.

UV = 1 pezzo

**Cierre central**

Cierre central prolongable 1500V con 1 bulón i.S. HBB/LBB 1281-1500 mm, plata.

CANTIDAD = 1 unidad



MC 201753

**Centre lock extendable**

Centre lock extendable 2200V with 2 i.S. HBB/LBB 1701-2200 mm, silver.

PU = 1 piece

**Chiusura centrale**

Chiusura centrale prolungabile 2200V con 2 funghi HBB/LBB 1701-2200 mm, argento.

UV = 1 pezzo

**Cierre central**

Cierre central prolongable 2200V con 2 bulones i.S. HBB/LBB 1701-2200 mm, plata.

CANTIDAD = 1 unidad



MC 201754

**Centre lock extendable**

Centre lock extendable 1280V with 1 i.S. HBB/LBB 801-1280 mm, silver.

PU = 1 piece

**Chiusura centrale**

Chiusura centrale prolungabile 1280V con 1 fungo HBB/LBB 801-1280 mm, argento.

UV = 1 pezzo

**Cierre central**

Cierre central prolongable 1280V con 1 bulón i.S. HBB/LBB 801-1280 mm, plata.

CANTIDAD = 1 unidad



MC 201840

**Tilt&Turn drive gear**

Tilt&Turn drive gear 2250 mm, BS 6.5 mm, variabel with 3 i.S. HBB 1751-2250 mm, silver.

PU = 1 piece

**Cremonese**

Cremonese 2250 mm, E 6.5 mm, variabile con 3 funghi HBB 1751-2250 mm, argento.

UV = 1 pezzo

**Falleba OB**

Falleba OB 2250 mm, EM 6.5 mm, cota variable con 3 bulones i.S. HBB 1751-2250 mm, plata.

CANTIDAD = 1 unidad



MC 202205

### Turn-only drive gear

Turn-only drive gear 660 mm,  
BS 6.5 mm, fixed handle height  
HBB 455-660 mm, HH 190 mm,  
silver.

PU = 1 piece

### Cremonese

Cremonese 660 mm, E 6.5 mm, fix  
con 1 fungo HBB 455-660 mm,  
HH 190 mm, argento.

UV = 1 pezzo

### Falleba OB

Falleba OB sin elevador 660 mm,  
EM 6.5 mm, fijo HBB 455-660 mm,  
HH 190 mm, plata.

CANTIDAD = 1 unidad



MC 202206

### Tilt&Turn drive gear

Tilt&Turn drive gear 840 mm,  
BS 6.5 mm, fixed handle height with  
1 i.S. HBB 661-840 mm, HH 300mm,  
silver.

PU = 1 piece

### Cremonese

Cremonese 840 mm, E 6.5 mm, fix  
con 1 fungo HBB 661-840 mm,  
HH 300 mm, argento.

UV = 1 pezzo

### Falleba OB

Falleba OB 840 mm, EM 6.5 mm,  
fijo con 1 bulón i.S. HBB 661-840  
mm, HH 300 mm, plata.

CANTIDAD = 1 unidad



MC 202207

### Tilt&Turn drive gear

Tilt&Turn drive gear 1090 mm,  
BS 6.5 mm, fixed handle height with  
1 i.S. HBB 841-1090 mm,  
HH 400 mm, silver.

PU = 1 piece

### Supporto cerniera

Cremonese 1090 mm, E 6.5 mm, fix  
con 1 fungo HBB 841-1090 mm,  
HH 400 mm, argento.

UV = 1 pezzo

### Falleba OB

Falleba OB 1090 mm, EM 6.5 mm,  
fijo con 1 bulón i.S. HBB 841-1090  
mm, HH 400 mm, plata.

CANTIDAD = 1 unidad



MC 202208

### Tilt&Turn drive gear

Tilt&Turn drive gear 1340 mm,  
BS 6.5 mm, fixed handle height with 1  
i.S. HBB 1091-1340 mm,  
HH 500 mm, silver.

PU = 1 piece

### Cremonese

Cremonese 1340 mm, E 6.5 mm, fix  
con 1 fungo HBB 1091-1340 mm,  
HH 500 mm, argento.

UV = 1 pezzo

### Falleba OB

Falleba OB 1340 mm, EM 6.5 mm,  
fijo con 1 bulón i.S. HBB 1091-1340  
mm, HH 500 mm, plata.

CANTIDAD = 1 unidad



MC 202209

**Tilt&Turn drive gear**

Tilt&Turn drive gear 1590 mm, BS 6.5 mm, fixed handle height with 2 i.S. HBB 1341-1590 mm, HH 600 mm, silver.

PU = 1 piece

**Cremonese**

Cremonese 1590 mm, E 6.5 mm, fix con 2 funghi HBB 1341-1590 mm, HH 600 mm, argento.

UV = 1 pezzo

**Falleba OB**

Falleba OB 1590 mm, EM 6.5mm, fijo con 2 bulones i.S. HBB 1341-1590 mm, HH 600 mm, plata.

CANTIDAD = 1 unidad



MC 202216

**Turn-only drive gear**

Turn-only drive gear 800 mm, BS 6.5 mm, variabel HBB 530-800 mm, silver.

PU = 1 piece

**Cremonese A-B**

Cremonese A-B 800 mm E 6.5 mm, variabile HBB 530-800 mm, argento.

UV = 1 pezzo

**Falleba OB**

Falleba OB sin elevador 800 mm, EM 6.5 mm, cota variable HBB 530-800 mm, plata.

CANTIDAD = 1 unidad



MC 202491

**Tilt&Turn drive gear**

Tilt&Turn drive gear 1250 mm, BS 6.5 mm, variabel with 1 i.S. HBB 801-1250 mm, silver.

PU = 1 piece

**Cremonese**

Cremonese 1250 mm, E 6.5 mm, variabile con 1 fungo HBB 801-1250 mm, argento.

UV = 1 pezzo

**Falleba OB**

Falleba OB 1250 mm, EM 6.5 mm, cota variable con 1 bulón i.S. HBB 801-1250 mm, plata.

CANTIDAD = 1 unidad



MC 202492

**Tilt&Turn drive gear**

Tilt&Turn drive gear 1750 mm, BS 6.5 mm, variabel with 2 i.S. HBB 1251-1750 mm, silver.

PU = 1 piece

**Cremonese**

Cremonese 1750 mm, E 6.5 mm, variabile con 2 funghi HBB 1251-1750 mm, argento.

UV = 1 pezzo

**Falleba OB**

Falleba OB 1750 mm, EM 6.5 mm, cota variable con 2 bulones i.S. HBB 1251-1750 mm, plata.

CANTIDAD = 1 unidad



MC 202494



### Turn-only drive gear

Turn-only drive gear 2250 mm, BS 6.5 mm, variabel with 3 i.S. HBB 1751-2250 mm, silver.

PU = 1 piece

### Cremonese A-B

Cremonese A-B 2250 mm, E 6.5 mm, variabile con 3 funghi HBB 1751-2250 mm, argento.

UV = 1 pezzo

### Falleba OB

Falleba OB sin elevador 2250 mm, EM 6.5 mm, cota variable con 3 bulones i.S. HBB 1751-2250 mm, plata.

CANTIDAD = 1 unidad



MC 202497

### Tilt&Turn drive gear

Tilt&Turn drive gear 1950 mm, BS 6.5 mm, fixed handle height with 3 i.S. HBB 1701-1950 mm, HH 1050 mm, silver.

PU = 1 piece

### Cremonese

Cremonese 1950 mm, E 6.5 mm, fix con 3 funghi HBB 1701-1950 mm, HH 1050 mm, argento.

UV = 1 pezzo

### Falleba OB

Falleba OB 1950 mm, EM 6.5 mm, fijo con 3 bulones i.S. HBB 1701-1950 mm, HH 1050 mm, plata.

CANTIDAD = 1 unidad



MC 202737

### Tilt&Turn drive gear

Tilt&Turn drive gear 2200 mm, BS 6.5 mm, fixed handle height with 3 i.S. HBB 1951-2200 mm, HH 1050 mm, silver.

PU = 1 piece

### Cremonese

Cremonese 2200 mm E 6.5 mm, fix con 3 funghi HBB 1951-2200 mm, HH 1050 mm, argento.

UV = 1 pezzo

### Falleba OB

Falleba OB 2200 m, EM 6.5 mm, fijo con 3 bulones i.S. HBB 1951-2200 mm, HH 1050 mm, plata.

CANTIDAD = 1 unidad



MC202738

### Faceplate extension

Faceplate extension, extendable 140 mm, silver.

PU = 1 piece

### Prolunga frontale

Prolunga frontale prolungabile 140 mm, argento.

UV = 1 pezzo

### Prolongador frontal

Prolongador frontal prolongable 140 mm, plata.

CANTIDAD = 1 unidad



MC 206630

### Corner element

Corner element horizontally extendable short for variable espagnolettes with 1 i.S. LBB 320-1800 mm, silver.

PU = 1 piece

### Movimento angolare

Movimento angolare prolungabile orizzontalmente corto per cremonese variabile con 1 fungo LBB 320-1800 mm, argento.

UV = 1 pezzo

### Mov.angular

Mov.angular corto para CV piv. horizontal prolong. con 1 bulón i.S. LBB 320-1800 mm, plata.

CANTIDAD = 1 unidad

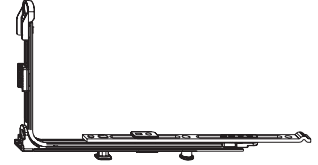

MC 206860

### Tilt&Turn drive gear

Tilt&Turn drive gear 1700 mm, BS 6.5 mm, fixed handle height with 2 i.S. HBB 1591-1700 mm, HH 700 mm, silver.

PU = 1 piece

### Cremonese

Cremonese 1700 mm, E 6.5 mm, fix con 2 funghi HBB 1591-1700 mm, HH 700 mm, argento.

UV = 1 pezzo

### Falleba OB

Falleba OB 1700 mm, EM 6.5 mm, fijo con 2 bulones i.S. HBB 1591-1700 mm, HH 700 mm, plata.

CANTIDAD = 1 unidad



MC 207305

### Espagnolette - centred handle

Espagnolette - centred handle height 500 mm, BS 6.5 mm, with 2 i.S., silver.

PU = 1 piece

### Asta rulli centrale

Asta rulli centrale 500 mm, E 6.5 mm, con 2 funghi, argento.

UV = 1 pezzo

### Falleba practicable

Falleba practicable 1 hoja centrada 500 mm, EM 6.5 mm, con 2 bulones i.S., plata.

CANTIDAD = 1 unidad



MC 208323

### Espagnolette - centred handle

Espagnolette - centred handle height 700 mm, BS 6.5 mm, with 2 i.S., silver.

PU = 1 piece

### Asta rulli centrale

Asta rulli centrale 700 mm, E 6.5 mm, con 2 funghi, argento.

UV = 1 pezzo

### Falleba practicable

Falleba practicable 1 hoja centrada 700 mm, EM 6.5 mm, con 2 bulones i.S., plata.

CANTIDAD = 1 unidad



MC 208324

**Espagnolette - centred handle**

Espagnolette - centred handle height 1000 mm, BS 6.5 mm, with 2 i.S., silver.

PU = 1 piece

**Asta rulli centrale**

Asta rulli centrale 1000 mm, E 6.5 mm, con 2 funghi, argento.

UV = 1 pezzo

**Falleba praticable**

Falleba praticable 1 hoja centrada 1000 mm, EM 6.5 mm, con 2 bulones i.S., plata.

CANTIDAD = 1 unidad



MC 208325

**Espagnolette - centred handle**

Espagnolette - centred handle height 1400 mm, BS 6.5 mm, with 3 i.S., silver.

PU = 1 piece

**Asta rulli centrale**

Asta rulli centrale 1400 mm, E 6.5 mm, con 3 funghi, argento.

UV = 1 pezzo

**Falleba praticable**

Falleba praticable 1 hoja centrada 1400 mm, EM 6.5 mm, con 3 bulones i.S., plata.

CANTIDAD = 1 unidad



MC 208326

**Espagnolette - centred handle**

Espagnolette - centred handle height 1800 mm, BS 6.5 mm, with 3 i.S., silver.

PU = 1 piece

**Asta rulli centrale**

Asta rulli centrale 1800 mm, E 6.5 mm, con 3 funghi, argento.

UV = 1 pezzo

**Falleba praticable**

Falleba praticable 1 hoja centrada 1800 mm, EM 6.5 mm, con 3 bulones i.S., plata.

CANTIDAD = 1 unidad



MC 208327

**End piece**

End piece bottom and top 180° with 1 i.S., silver.

PU = 1 piece

**Terminale**

Terminale 180° inferiore e superiore con 1 fungo, argento.

UV = 1 pezzo

**Terminal**

Terminal 180° inferior y superior con 1 bulón i.S., plata.

CANTIDAD = 1 unidad



MC 212211

### Stabilizing scissor stay

Stabilizing scissor stay mounted without night-vent, silver.

PU = 1 piece

### Forbice supplementare

Forbice supplementare premontata senza aerazione, argento.

UV = 1 pezzo

### Compás adicional

Compás adicional premontado sin microventilación, plata.

CANTIDAD = 1 unidad



MC 213043

### Bullet catch timber

Bullet catch 18 mm, rebate depth 9 mm offset and 22 mm rebate depth 13 mm offset, silver.

PU = 1 piece

### Scrocco rullo

Scrocco rullo PB18 mm, scostamento 9 mm e PB 22 mm scostamento 13 mm, argento.

UV = 1 pezzo

### Retenedor madera Base

Retenedor base 18 mm, desperdicio 9 mm y Base 22 mm desperdicio 13 mm, plata.

CANTIDAD = 1 unidad



MC 213461

### French casement lock

Extendable french casement lock with flat fixing tab, with 1 i.S. LBB 240-1650 mm, silver.

PU = 1 piece

### Catenaccio orizzontale

Catenaccio orizzontale prolungabile per nodo centrale liscio con 1 fungo LBB 240-1650 mm, argento.

UV = 1 pezzo

### Pasador horizontal

Pasador horizontal prolongable para montante central de base lisa con 1 bulón i.S. LBB 240-1650 mm, plata.

CANTIDAD = 1 unidad

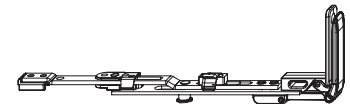

MC 215336

### Concealed compression lock ES

Concealed compression lock ES for Eurogroove sash component with lateral adjustment, silver.

PU = 1 piece

### Cerniera aggiuntiva a scomparsa

Cerniera centrale a scomparsa regolabile per cava ferramenta parte anta, argento.

UV = 1 pezzo

### Cierre de presión

Cierre de presión oculto regulable para canal de herraje parte hoja, plata.

CANTIDAD = 1 unidad



MC 215577

### Corner support

Corner support 13 mm offset R, silver.

R = Right opening

PU = 1 piece

### Piastra cerniera

Angolo cerniera scostamento 13 mm R, argento.

R = Apertura destra

UV = 1 pezzo

### Bisagra angular

Bisagra angular desperdicio 13 mm R, plata.

R = Apertura derecha

CANTIDAD = 1 unidad

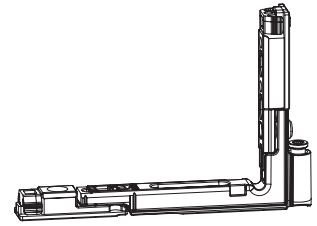

MC 215804

### Corner support

Corner support 13 mm offset L, silver.

L = Left opening

PU = 1 piece

### Braccio cerniera superiore

Angolo cerniera scostamento 13 mm L, argento.

L = Apertura sinistra

UV = 1 pezzo

### Bisagra angular

Bisagra angular desperdicio 13 mm L, plata.

L = Apertura izquierda

CANTIDAD = 1 unidad

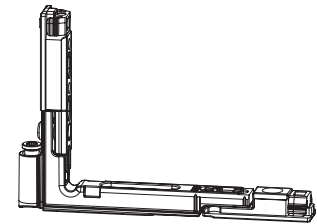

MC 215805

### Pivot post

Pivot post R, 24 mm rebate depth 13 mm offset, silver.

R = Right opening

PU = 1 piece

### Cerniere angolare

Cerniere angolare PB 24 mm scostamento 13 mm R, argento.

R = Apertura destra

UV = 1 pezzo

### Soporte bisagra

Soporte bisagra base 24 mm desperdicio 13 mm R, plata.

R = Apertura derecha

CANTIDAD = 1 unidad

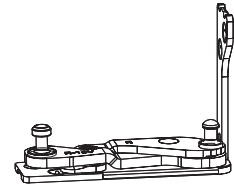

MC 215810

### Pivot post

Pivot post L, 24 mm rebate depth 13 mm offset, silver.

L = Left opening

PU = 1 piece

### Supporto cerniera

Cerniere angolare PB 24 mm scostamento 13mm L, argento.

L = Apertura sinistra

UV = 1 pezzo

### Soporte bisagra

Soporte bisagra base 24 mm desperdicio 13 mm L, plata.

L = Apertura izquierda

CANTIDAD = 1 unidad

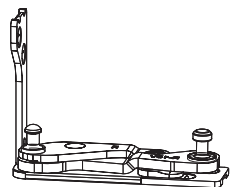

MC 215811

**Tilt&Turn/tilt-first scissor**

Tilt&Turn/tilt-first scissor stay  
faceplate 600 mm,  
LBB 465-600 mm, silver.

PU = 1 piece

**Frontale a forbice**

Frontale forbice A-R/R-A 600 mm,  
LBB 465-600 mm, argento.

UV = 1 pezzo

**Frontal compás**

Frontal compás para OB y apertura  
lógica 600 mm, LBB 465-600 mm,  
plata.

CANTIDAD = 1 unidad



MC 217346

**Tilt&Turn/tilt-first scissor**

Tilt&Turn/tilt-first scissor stay  
faceplate 800 mm,  
LBB 601-800 mm, silver.

PU = 1 piece

**Frontale a forbice**

Frontale forbice A-R/R-A 800 mm,  
LBB 601-800 mm, argento.

UV = 1 pezzo

**Frontal compás**

Frontal compás para OB y apertura  
lógica 800 mm, LBB 601-800 mm,  
plata.

CANTIDAD = 1 unidad



MC 217347

**Tilt&Turn/tilt-first scissor**

Tilt&Turn/tilt-first scissor stay  
faceplate 1050 mm,  
LBB 801-1050 mm, with 1 i.S.,  
silver.

PU = 1 piece

**Frontale a forbice**

Frontale forbice A-R/R-A 1050 mm,  
LBB 801-1050 mm, con 1 fungo,  
argento.

UV = 1 pezzo

**Frontal compás**

Frontal compás para OB y apertura  
lógica 1050 mm, LBB 801-1050  
mm, con 1 bulón i.S., plata.

CANTIDAD = 1 unidad



MC 217348

**Tilt&Turn/tilt-first scissor**

Tilt&Turn/tilt-first scissor stay  
faceplate 1300 mm,  
LBB 1051-1300 mm, with 1 i.S.,  
silver.

PU = 1 piece

**Frontale a forbice**

Frontale forbice A-R/R-A 1300 mm,  
LBB 1051-1300 mm, con 1 fungo,  
argento.

UV = 1 pezzo

**Frontal compás**

Frontal compás para OB y apertura  
lógica 1300 mm, LBB 1051-1300  
mm, con 1 bulón i.S., plata.

CANTIDAD = 1 unidad



MC 217349

**Tilt&Turn scissor stay**

Tilt&Turn scissor stay arm with bearing 600/800 mm, 24 mm rebate depth 13 mm offset R, LBB 370-800 mm, silver.

R = Right opening

PU = 1 piece

**Braccio a forbice A-R**

Braccio forbice A-R con supporto 600/800 mm, PB 24 mm scostamento 13 mm R, LBB 370-800 mm, argento.

R = Apertura destra

UV = 1 pezzo

**Brazo compás OB**

Brazo compás OB con soporte 600/800 mm, Base 24 mm desperdicio 13 mm R, LBB 370-800 mm, plata.

R = Apertura derecha

CANTIDAD = 1 unidad



MC 217470

**Tilt&Turn scissor stay**

Tilt&Turn scissor stay arm with bearing 600/800 mm, 24 mm rebate depth 13 mm offset L, LBB 370-800 mm, silver.

L = Left opening

PU = 1 piece

**Braccio a forbice A-R**

Braccio forbice A-R con supporto 600/800 mm, PB 24 mm scostamento 13 mm L, LBB 370-800 mm, argento.

L = Apertura sinistra

UV = 1 pezzo

**Brazo compás OB**

Brazo compás OB con soporte 600/800 mm, Base 24 mm desperdicio 13 mm L, LBB 370-800 mm, plata.

L = Apertura izquierda

CANTIDAD = 1 unidad



MC 217471

**Tilt&Turn scissor stay**

Tilt&Turn scissor stay arm with bearing 1050/1300 mm, 24 mm rebate depth 13 mm offset R, LBB 801-1300 mm, silver.

R = Right opening

PU = 1 piece

**Braccio a forbice A-R**

Braccio forbice A-R con supporto 1050/1300 mm, PB 24 mm scostamento 13 mm R, LBB 801-1300 mm, argento.

R = Apertura destra

UV = 1 pezzo

**Brazo compás OB**

Brazo compás OB con soporte 1050/1300 mm, Base 24 mm desperdicio 13 mm R, LBB 801-1300 mm, plata.

R = Apertura derecha

CANTIDAD = 1 unidad



MC 217474

**Tilt&Turn scissor stay**

Tilt&Turn scissor stay arm with bearing 1050/1300 mm, 24 mm rebate depth 13 mm offset L, LBB 801-1300 mm, silver.

L = Left opening

PU = 1 piece

**Braccio a forbice A-R**

Braccio forbice A-R con supporto 1050/1300 mm, PB 24 mm scostamento 13 mm L, LBB 801-1300 mm, argento.

L = Apertura sinistra

UV = 1 pezzo

**Soporte bisagra**

Brazo compás OB con soporte 1050/1300 Base 24 mm desperdicio 13 mm L, LBB 801-1300 mm, plata.

L = Apertura izquierda

CANTIDAD = 1 unidad



MC 217475

**Turn-only hinge arm**

Turn-only hinge arm with hinge V2 R, 24 mm rebate depth LBB 255-1400 mm, 13 mm offset, silver.

R = Right opening

PU = 1 piece

**Braccio cerniera A-B**

Braccio cerniera A-B con supporto (V2) R, PB 24 mm LBB 255-1400 mm, scostamento 13 mm, argento.

R = Apertura destra

UV = 1 pezzo

**Brazo falso compás**

Brazo falso compás con soporte V2 R, base 24 mm LBB 255-1400 mm, desperdicio 13 mm, plata.

R = Apertura derecha

CANTIDAD = 1 unidad

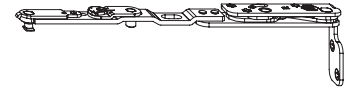

MC 217691

**Turn-only hinge arm**

Turn-only hinge arm with hinge V2 L, 24 mm rebate depth, LBB 255-1400 mm, 13 mm offset, silver.

L = Left opening

PU = 1 piece

**Braccio cerniera A-B**

Braccio cerniera A-B con supporto (V2) L, PB 24 mm LBB 255-1400 mm, scostamento 13 mm, argento.

L = Apertura sinistra

UV = 1 pezzo

**Cerradero compás**

Brazo falso compás con soporte V2 L, base 24 mm LBB 255-1400 mm, desperdicio 13 mm, plata.

L = Apertura izquierda

CANTIDAD = 1 unidad

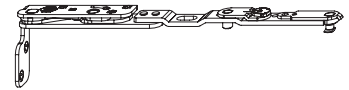

MC 217692

**Tilt-only hinge arm**

Tilt-only hinge arm with hinge V2 R, 24 mm rebate depth 13 mm offset, silver.

R = Right opening

PU = 1 piece

**Braccio ribalta**

Braccio ribalta con supporto (V2) R, PB 24 mm scostamento 13 mm, argento.

R = Apertura destra

UV = 1 pezzo

**Brazo abatible**

Brazo abatible con soporte V2 R, Base 24 mm desperdicio 13 mm, plata.

R = Apertura derecha

CANTIDAD = 1 unidad

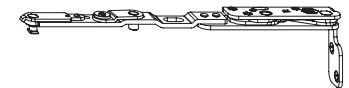

MC 217723

**Tilt-only hinge arm**

Tilt-only hinge arm with hinge V2 L, 24 mm rebate depth 13 mm offset, silver.

L = Left opening

PU = 1 piece

**Braccio ribalta**

Braccio ribalta con supporto (V2) L, PB 24 mm scostamento 13 mm, argento.

L = Apertura sinistra

UV = 1 pezzo

**Brazo abatible**

Brazo abatible con soporte V2 L, Base 24 mm desperdicio 13 mm, plata.

L = Apertura izquierda

CANTIDAD = 1 unidad

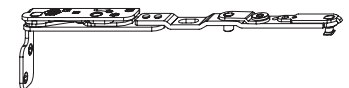

MC 217724



**Tilt-only hinge and  
turn-only hinge**

Turn-only and tilt-only faceplate  
FHH V2, LBB 255-1400 mm, silver.

PU = 1 piece

**Cerniera AB/ ribalta**

Cerniera AB/ ribalta parte anta (V2),  
LBB 255-1400 mm, argento.

UV = 1 pezzo

**Falso compás**

Falso compás practicable y  
abatible fijo V2, LBB 255-1400 mm,  
plata.

CANTIDAD = 1 unidad

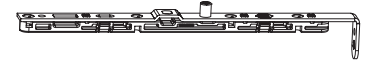

MC 217729

**Corner element**

Corner element with 1 i.S.  
LBB 320-1800 mm, silver.

PU = 1 piece

**Movimento angolare**

Movimento angolare con 1 fungo  
LBB 320-1800 mm, argento.

UV = 1 pezzo

**Mov.angular**

Mov.angular con 1 bulón i.S.  
LBB 320-1800 mm, plata.

CANTIDAD = 1 unidad



MC 222201

**Corner element**

Corner element short with 1 i.S.  
LBB 220-319 mm, silver.

PU = 1 piece

**Movimento angolare**

Movimento angolare corto con 1  
fungo LBB 220-319 mm, argento.

UV = 1 pezzo

**Mov.angular**

Mov.angular corta con 1 bulón i.S.  
LBB 220-319 mm, plata.

CANTIDAD = 1 unidad

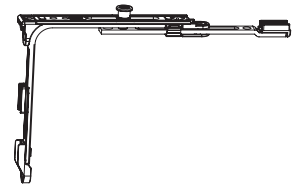

MC 222203

**Corner element**

Corner element horizontally  
extendable with 1 i.S.  
LBB 320-1800 mm, silver.

PU = 1 piece

**Movimento angolare**

Movimento angolare prolungabile  
orizzontalmente con 1 fungo  
LBB 320-1800 mm, argento.

UV = 1 pezzo

**Mov.angular**

Mov.angular para CF piv.horizontal  
prolong. con 1 bulón i.S.  
LBB 320-1800 mm, plata.

CANTIDAD = 1 unidad

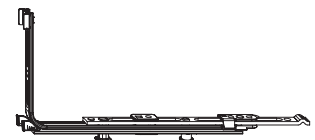

MC 222205

### Corner element

Corner element horizontally extendable for variable drive gear with 1 i.S. LBB 320-1800 mm, silver.

PU = 1 piece

### Movimento angolare

Movimento angolare prolungabile orizzontalmente per cremonese variabile con 1 fungo LBB 320-1800 mm, argento.

UV = 1 pezzo

### Mov.angular

Mov.angular para CV piv.horizontal prolong. con 1 bulón i.S. LBB 320-1800 mm, plata.

CANTIDAD = 1 unidad

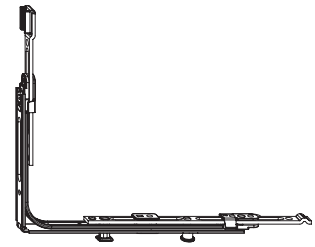

MC 222206

### Corner element

Corner element vertically extendable with 1 i.S. HBB 750-2800 mm, silver.

PU = 1 piece

### Movimento angolare

Movimento angolare prolungabile verticalmente con 1 fungo HBB 750-2800 mm, argento.

UV = 1 pezzo

### Esquina angular

Mov.angular de conexión rápida prolong. con 1 bulón i.S. HBB 750-2800 mm, plata.

CANTIDAD = 1 unidad

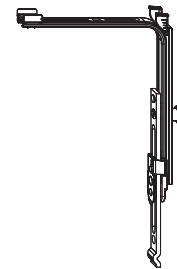

MC 222209

### Travel restriction

90° Travel restriction surface-mounted, silver.

PU = 1 piece

### Delimitatore di ribalta

Delimitatore di ribalta su movimento angolare, argento.

UV = 1 pezzo

### Tapón delimitador

Tapón delimitador 90° atornillable, plata.

CANTIDAD = 1 unidad



MC 357081

### Lifting component

Lifting component R, silver.

R = Right opening

PU = 1 piece

### Scontro alza anta

Scontro alza anta R, argento.

R = Apertura destra

UV = 1 pezzo

### Cerradero elevador

Cerradero elevador R, plata.

R = Apertura derecha

CANTIDAD = 1 unidad

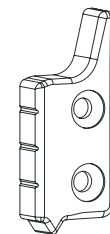

MC 361004

### Lifting component

Lifting component L, silver.

L = Left opening

PU = 1 piece

### Scontro alza anta

Scontro alza anta sinistro, argento.

L = Apertura sinistra

UV = 1 pezzo

### Cerradero elevador

Cerradero elevador IZQ, plata.

L = Apertura izquierda

CANTIDAD = 1 unidad

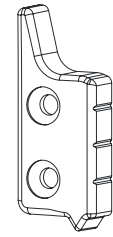

MC 361005

### Packer for bullet

Packer for bullet catch for Eurogroove 2.2x15.9x30 mm, silver.

PU = 1 piece

### Spessore per scrocco

Spessore per scrocco rullo per cava ferramenta 2.2x15.9x30 mm, argento.

UV = 1 pezzo

### Calce para

Calce para rodillo para canal de herraje 2.2x15.9x30 mm, plata.

CANTIDAD = 1 unidad

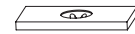

MC 362059

### Bullet-catch

Bullet-catch roll steel, silver.

PU = 1 piece

### Rullino scrocco anta

Rullino scrocco anta semifissa acciaio, argento.

UV = 1 pezzo

### Tetón para retenedor

Tetón para retenedor de hoja semi fija acero, plata.

CANTIDAD = 1 unidad



MC 362446

### Striker plate

Striker plate i.S., silver.

PU = 1 pieceww

### Scontro fungo

Scontro fungo, argento.

UV = 1 pezzo

### Cerradero de seguridad

Cerradero de seguridad, plata.

CANTIDAD = 1 unidad



MC 364310

**Strike plate for concealed  
compression**

Strike plate for concealed  
compression lock ES Euro-channel  
24 mm rebate depth 13 mm offset  
frame component, pearl light grey  
RAL9022.

PU = 1 piece

**Riscontro per cerniera  
centrale**

Riscontro per cerniera centrale a  
scomparsa regolabile battuta liscia  
PB 24 mm scostamento 13 mm  
parte telaio, grigio chiaro perlato  
RAL9022.

UV = 1 pezzo

**Pieza de bloqueo para  
cierre de presión**

Pieza de bloqueo para cierre de  
presión oculto regulable base lisa  
24 mm parte marco desperdicio 13  
mm, gris claro perla RAL9022.

CANTIDAD = 1 unidad



MC 365161

**Flat magnet contact**

Flat magnet contact for surface  
safety class 2 cable 3 m, light grey  
RAL7035.

PU = 1 piece

**Contatto magnetico**

Contatto magnetico piatto per  
superficie grado protezione 2 cavo  
3 m, grigio luce RAL7035.

UV = 1 pezzo

**Contacto magnético**

Contacto magnético plano  
superficial GR 2 cable 3 m, gris  
luminoso RAL7035.

CANTIDAD = 1 unidad

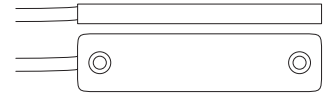

MC 473010



**Basic kits for Tilt&Turn windows**

**Kit base per finestra anta ribalta**

**Kits básicos para ventana oscilante**

**K88001**  
Standard windows

LBB = 465 - 1400 mm  
HBB = 455 - 2800 mm

MC 222201 n°01 piece  
MC 222209 n°01 piece  
MC 364310 n°02 pieces

**K88001**  
Finestre standard

LBB = 465 - 1400 mm  
HBB = 455 - 2800 mm

**K88001**  
Ventanas estándar

LBB = 465 - 1400 mm  
HBB = 455 - 2800 mm



**K88002**

LBB = 370 - 464 mm  
HBB = 455 - 2800 mm

MC 222203 n°01 piece  
MC 222209 n°01 piece  
MC 364310 n°02 pieces

**K88002**

LBB = 370 - 464 mm  
HBB = 455 - 2800 mm

**K88002**

LBB = 370 - 464 mm  
HBB = 455 - 2800 mm



**K88002**  
Short corner  
for low windows

LBB = 465 - 815 mm  
HBB = 370 - 454 mm

MC 222203 n°01 piece  
MC 222209 n°01 piece  
MC 364310 n°02 pieces

**K88002**  
Angolo ridotto  
per finestre basse

LBB = 465 - 815 mm  
HBB = 370 - 454 mm

**K88002**  
Esquina corta  
para ventanas bajas

LBB = 465 - 815 mm  
HBB = 370 - 454 mm

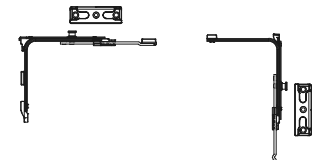

**Gear kits**

**Kit cremonese**

**Kits de equipo**

K88003

HH = 190 mm  
HBB = 340 - 1608 mm

MC 202206 n°01 piece  
MC 222205 n°01 piece  
MC 364310 n°01 piece

K88003

HH = 190 mm  
HBB = 340 - 1608 mm

K88003

HH = 190 mm  
HBB = 340 - 1608 mm

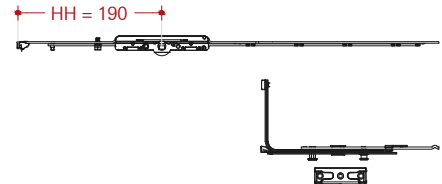

K88004

HH = 300 mm  
HBB = 661 - 1790 mm

MC 202207 n°01 piece  
MC 222205 n°01 piece  
MC 364310 n°02 pieces

K88004

HH = 300 mm  
HBB = 661 - 1790 mm

K88004

HH = 300 mm  
HBB = 661 - 1790 mm

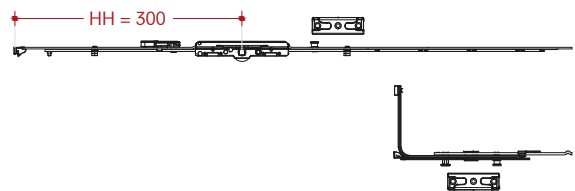

K88005

HH = 400 mm  
HBB = 841 - 2040 mm

MC 202208 n°01 piece  
MC 222205 n°01 piece  
MC 364310 n°02 pieces

K88005

HH = 400 mm  
HBB = 841 - 2040 mm

K88005

HH = 400 mm  
HBB = 841 - 2040 mm

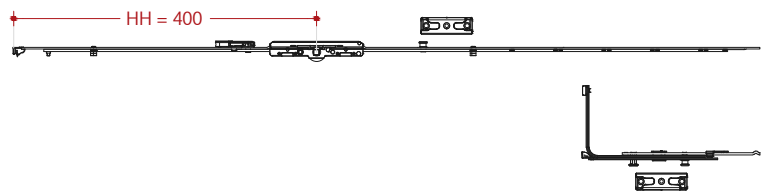

K88006

HH = 500 mm  
HBB = 1091 - 2290 mm

MC 202209 n°01 piece  
MC 222205 n°01 piece  
MC 364310 n°02 pieces

K88006

HH = 500 mm  
HBB = 1091 - 2290 mm

K88006

HH = 500 mm  
HBB = 1091 - 2290 mm

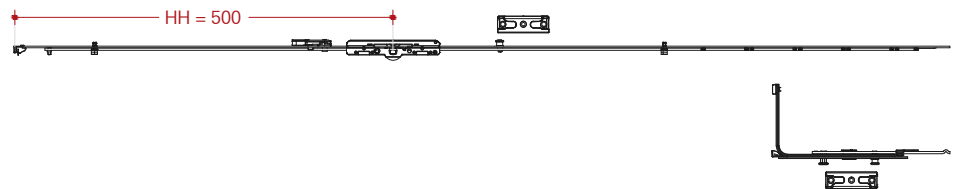

**Gear kits**

**Kit cremonese**

**Kits de equipo**

K88007

HH = 600 mm  
HBB = 1341 - 2540 mm

K88007

HH = 600 mm  
HBB = 1341 - 2540 mm

K88007

HH = 600 mm  
HBB = 1341 - 2540 mm

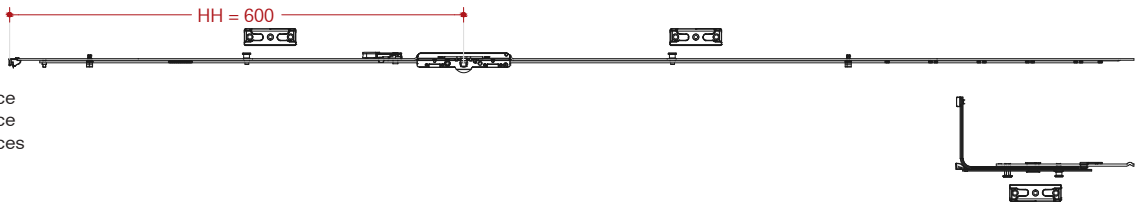

MC 202216 n°01 piece  
MC 222205 n°01 piece  
MC 364310 n°03 pieces

K88008

HH = 700 mm  
HBB = 1591 - 2650 mm

K88008

HH = 700 mm  
HBB = 1591 - 2650 mm

K88008

HH = 700 mm  
HBB = 1591 - 2650 mm

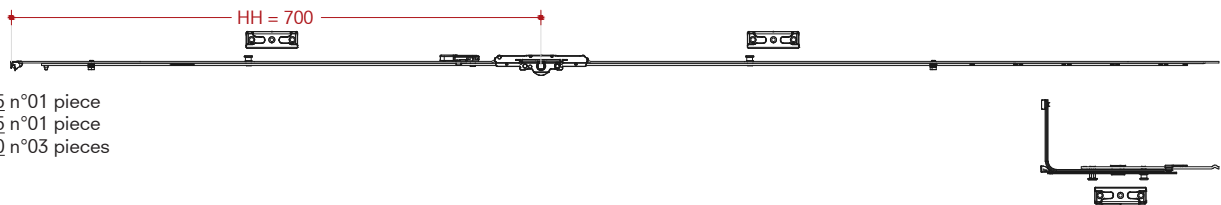

MC 207305 n°01 piece  
MC 222205 n°01 piece  
MC 364310 n°03 pieces

K88009

HH = 1050 mm  
HBB = 1701 - 2900 mm

K88009

HH = 1050 mm  
HBB = 1701 - 2900 mm

K88009

HH = 1050 mm  
HBB = 1701 - 2900 mm

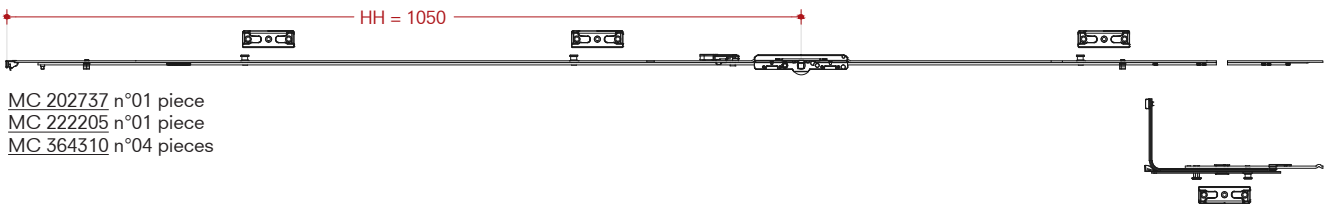

MC 202737 n°01 piece  
MC 222205 n°01 piece  
MC 364310 n°04 pieces

K88010

HH = 1050 mm  
HBB = 1951 - 3150 mm

K88010

HH = 1050 mm  
HBB = 1951 - 3150 mm

K88010

HH = 1050 mm  
HBB = 1951 - 3150 mm

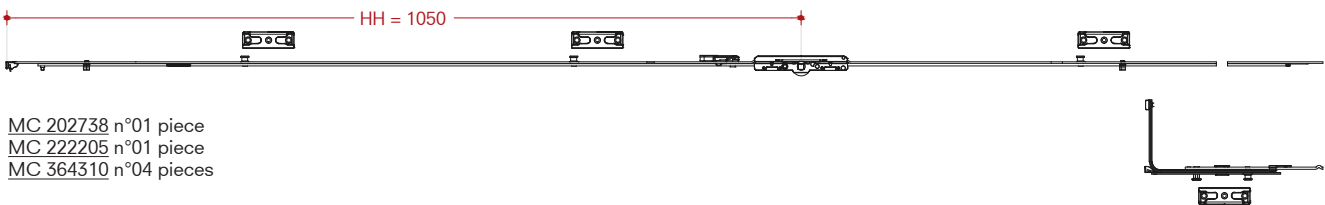

MC 202738 n°01 piece  
MC 222205 n°01 piece  
MC 364310 n°04 pieces



**Extension kits**

**Kit prolunga**

**Kits extensión**

K88011

0 - 140 mm

MC 206630 n°01 piece

K88011

0 - 140 mm

K88011

0 - 140 mm



K88012

141 - 235 mm

MC 201750 n°01 piece  
MC 364310 n°01 piece

K88012

141 - 235 mm

K88012

141 - 235 mm



K88059

236 - 375 mm

MC 201750 n°01 piece  
MC 206630 n°01 piece  
MC 364310 n°01 piece

K88059

236 - 375 mm

K88059

236 - 375 mm



K88013

376 - 470 mm

MC 201840 n°01 piece  
MC 364310 n°01 piece

K88013

376 - 470 mm

K88013

376 - 470 mm



**Extension kits**

**Kit prolunga**

**Kits extensión**

K88014

471 - 610 mm

MC 201840 n°01 piece  
MC 206630 n°01 piece  
MC 364310 n°01 piece

K88014

471 - 610 mm

K88014

471 - 610 mm



K88015

611 - 705 mm

MC 201750 n°01 piece  
MC 201840 n°01 piece1  
MC 364310 n°02 pieces

K88015

611 - 705 mm

K88015

611 - 705 mm



K88060

706 - 845 mm

MC 206630 n°01 piece  
MC 201750 n°01 piece  
MC 201840 n°01 piece  
MC 364310 n°02 pieces

K88060

706 - 845 mm

K88060

706 - 845 mm



K88016

846 - 940 mm

MC 201840 n°02 pieces  
MC 364310 n°02 pieces

K88016

846 - 940 mm

K88016

846 - 940 mm



**Scissors and hinges kits**  
Right opening

**Kit forbice e cerniere**  
Apertura destra

**Kits de cizallas y bisagras**  
Apertura derecha

K88017

LBB = 370 - 600 mm

MC 217470 n°01 piece  
MC 217346 n°01 piece  
MC 215804 n°01 piece  
MC 215810 n°01 piece  
MC 361004 n°01 piece

K88017

LBB = 370 - 600 mm

K88017

LBB = 370 - 600 mm



K88018

LBB = 601 - 800 mm

MC 217470 n°01 piece  
MC 217347 n°01 piece  
MC 215804 n°01 piece  
MC 215810 n°01 piece  
MC 361004 n°01 piece

K88018

LBB = 601 - 800 mm

K88018

LBB = 601 - 800 mm



K88019

LBB = 801 - 1050 mm

MC 217474 n°01 piece  
MC 217348 n°01 piece  
MC 215804 n°01 piece  
MC 215810 n°01 piece  
MC 361004 n°01 piece  
MC 364310 n°01 piece

K88019

LBB = 801 - 1050 mm

K88019

LBB = 801 - 1050 mm

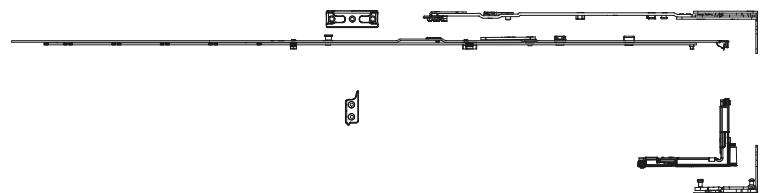

**Scissors and hinges kits**  
Right opening

**Kit forbice e cerniere**  
Apertura destra

**Kits de cizallas y bisagras**  
Apertura derecha

K88020

LBB = 1051 - 1200 mm

MC 217474 n°01 piece  
MC 217349 n°01 piece  
MC 215804 n°01 piece  
MC 215810 n°01 piece  
MC 361004 n°01 piece  
MC 364310 n°01 piece

K88020

LBB = 1051 - 1200 mm

K88020

LBB = 1051 - 1200 mm

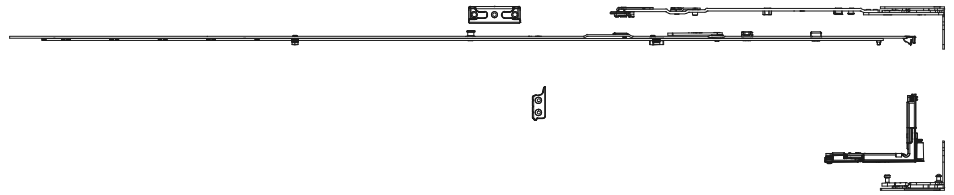

K88021

LBB = 1201 - 1400 mm

MC 217474 n°01 piece  
MC 217349 n°01 piece  
MC 213043 n°01 piece  
MC 52794 n°01 piece  
MC 215804 n°01 piece  
MC 215810 n°01 piece  
MC 361004 n°01 piece  
MC 364310 n°01 piece

K88021

LBB = 1201 - 1400 mm

K88021

LBB = 1201 - 1400 mm

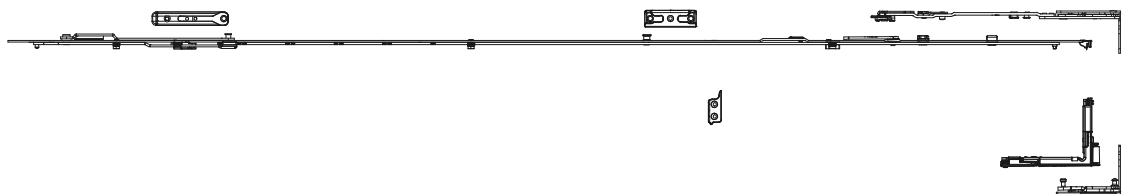

**Scissors and hinges kits**  
Left opening

**Kit forbice e cerniere**  
Apertura sinistra

**Kits de cizallas y bisagras**  
Apertura izquierda

K88022

LBB = 370 - 600 mm

MC 217471 n°01 piece  
MC 217346 n°01 piece  
MC 215805 n°01 piece  
MC 215811 n°01 piece  
MC 361005 n°01 piece

K88022

LBB = 370 - 600 mm

K88022

LBB = 370 - 600 mm

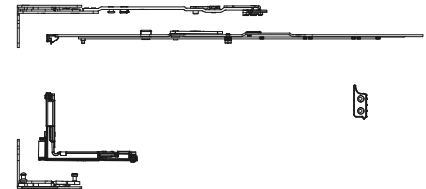

K88023

LBB = 601 - 800 mm

MC 217471 n°01 piece  
MC 217347 n°01 piece  
MC 215805 n°01 piece  
MC 215811 n°01 piece  
MC 361005 n°01 piece

K88023

LBB = 601 - 800 mm

K88023

LBB = 601 - 800 mm



K88024

LBB = 801 - 1050 mm

MC 217475 n°01 piece  
MC 217348 n°01 piece  
MC 215805 n°01 piece  
MC 215811 n°01 piece  
MC 361005 n°01 piece  
MC 364310 n°01 piece

K88024

LBB = 801 - 1050 mm

K88024

LBB = 801 - 1050 mm

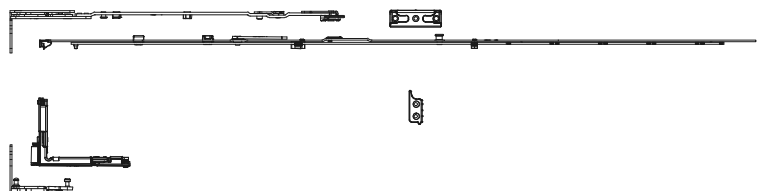

**Scissors and hinges kits**  
Left opening

**Kit forbice e cerniere**  
Apertura sinistra

**Kits de cizallas y bisagras**  
Apertura izquierda

K88025

LBB = 1051 - 1200 mm

MC 217475 n°01 piece  
MC 217349 n°01 piece  
MC 215805 n°01 piece  
MC 215811 n°01 piece  
MC 361005 n°01 piece  
MC 364310 n°01 piece

K88025

LBB = 1051 - 1200 mm

K88025

LBB = 1051 - 1200 mm

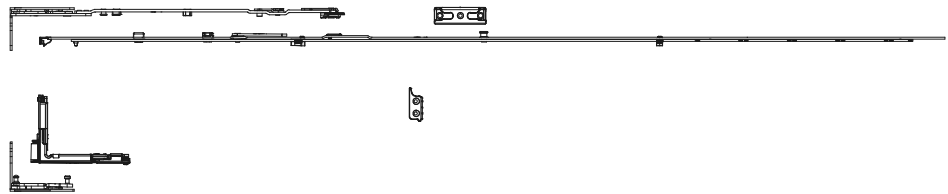

K88026

LBB = 1201 - 1400 mm

MC 217475 n°01 piece  
MC 217349 n°01 piece  
MC 213043 n°01 piece  
MC 52794 n°01 piece  
MC 215805 n°01 piece  
MC 215811 n°01 piece  
MC 361005 n°01 piece  
MC 364310 n°01 piece

K88026

LBB = 1201 - 1400 mm

K88026

LBB = 1201 - 1400 mm

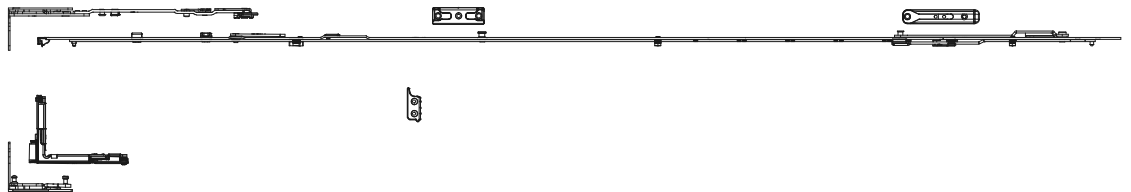

**Additional hinge side locking point**

**Punto di chiusura aggiuntivo lato cerniera**

**Punto de bloqueo adicional lado de la bisagra**

K88027

HBB = 801 - 1280 mm

MC 201751 n°01 piece  
MC 364310 n°01 piece

K88027

HBB = 801 - 1280 mm

K88027

HBB = 801 - 1280 mm



K88028

HBB = 1281 - 1500 mm

MC 201752 n°01 piece  
MC 364310 n°01 piece

K88028

HBB = 1281 - 1500 mm

K88028

HBB = 1281 - 1500 mm



K88029

HBB = 1501 - 1700 mm

MC 201840 n°01 piece  
MC 201753 n°01 piece  
MC 364310 n°02 pieces

K88029

HBB = 1501 - 1700 mm

K88029

HBB = 1501 - 1700 mm



K88030

HBB = 1701 - 2800 mm

MC 201754 n°01 piece  
MC 364310 n°02 pieces

K88030

HBB = 1701 - 2800 mm

K88030

HBB = 1701 - 2800 mm



**Additional hinge bottom side  
locking point**

**Punto di chiusura aggiuntivo  
lato inferiore cerniera**

**Punto de bloqueo adicional  
lado inferior de la bisagra**

K88031

LBB = 801 - 1280 mm

MC 201751 n°01 piece  
MC 364310 n°01 piece

K88031

LBB = 801 - 1280 mm

K88031

LBB = 801 - 1280 mm



K88032

LBB = 1281 - 1400 mm

MC 201752 n°01 piece  
MC 364310 n°01 piece

K88032

LBB = 1281 - 1400 mm

K88032

LBB = 1281 - 1400 mm





**Hinges kits**  
2nd leaf

**Kit cerniere**  
2a anta

**Kits de bisagras**  
2do hoja

K88034

Right hinges

MC 217691 n°01 piece  
MC 217729 n°01 piece  
MC 215804 n°01 piece  
MC 215810 n°01 piece

K88034

Cerniere destre

K88034

Derecha bisagras

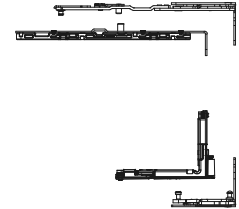

K88035

Left hinges

MC 217692 n°01 piece  
MC 217729 n°01 piece  
MC 215805 n°01 piece  
MC 215811 n°01 piece

K88035

Cerniere sinistre

K88035

Izquierda bisagras

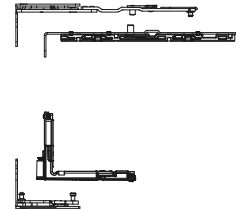

**Concealed compression locks kits**

**Kit cerniere centrali a scomparsa**

**Kits de bisagras ocultas centrales**

K88036

HBB = 1280 - 2000 mm

MC 215577 n°01 piece  
MC 365161 n°01 piece

K88036

HBB = 1280 - 2000 mm

K88036

HBB = 1280 - 2000 mm



K88037

HBB = 2001 - 2800 mm

MC 215577 n°01 piece  
MC 365161 n°01 piece

K88037

HBB = 2001 - 2800 mm

K88037

HBB = 2001 - 2800 mm

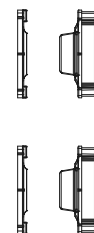

**French casement lock  
extendable**

**Catenacci angolari  
estendibili**

**Cerradura abatible francesa  
extensible**

K88038

LBB = 370 - 800 mm

MC 215336 n°02 pieces  
MC 364310 n°02 pieces

K88038

LBB = 370 - 800 mm

K88038

LBB = 370 - 800 mm

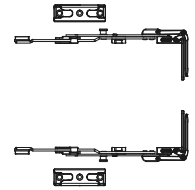

K88039

LBB = 801 - 1400 mm

MC 215336 n°02 pieces  
MC 201751 n°02 pieces  
MC 364310 n°04 pieces

K88039

LBB = 801 - 1400 mm

K88039

LBB = 801 - 1400 mm

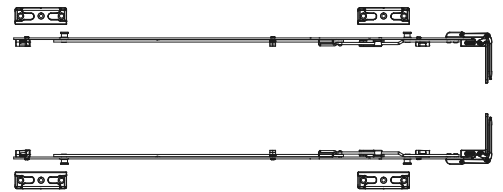

**Roller snap catch**

**Scrocco a rullo**

**Pestillo de rodillo**

K88201

MC 213461 n°02 pieces  
MC 362059 n°02 pieces  
MC 362446 n°02 pieces

K88201

K88201



**Extendable french casement lock +  
upper roller snap catch**

**Serratura anta francese estensibile  
+ scrocco a rullo superiore**

**Cerradura de marco francés  
extensible + cierre de presión de  
rodillo superior**

K88041

LBB = 370 - 800 mm

MC 213461 n°01 piece  
MC 362059 n°01 piece  
MC 362446 n°01 piece  
MC 215336 n°01 piece  
MC 364310 n°01 piece

K88041

LBB = 370 - 800 mm

K88041

LBB = 370 - 800 mm

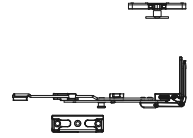

K88042

LBB = 801 - 1280 mm

MC 213461 n°01 piece  
MC 362059 n°01 piece  
MC 362446 n°01 piece  
MC 215336 n°01 piece  
MC 201751 n°01 piece  
MC 364310 n°02 pieces

K88042

LBB = 801 - 1280 mm

K88042

LBB = 801 - 1280 mm

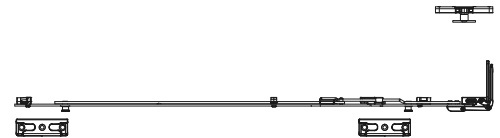

**Door catch**

**Scrocco porta**

**Pestillo de puerta**

K88061

HBB = 661 - 2800 mm

MC 201168 n°01 piece

K88061

HBB = 661 - 2800 mm

K88061

HBB = 661 - 2800 mm



**Opening restrictor**

**Limitatore di apertura**

**Limitador de apertura**

K88033

LBB = 490 - 1400 mm

MC 103623 n°01 piece

K88033

LBB = 490 - 1400 mm

K88033

LBB = 490 - 1400 mm



**Flush bolt**

**Catenaccio**

**Pasador de canto**

E99030-02

Flush bolt for two leaves, pair, with strike plate, galvanized steel.

MC 55167 n°01 piece  
MC 214293 n°01 piece  
MC 210279 n°02 pieces

E99030-02

Catenaccio, coppia, con riscontro, per due ante, acciaio zincato.

E99030-02

Pasador de canto, par, con pieza de bloqueo, para dos hojas, acero galvanizado.

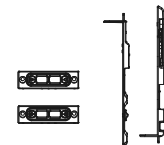

**Load transfer 180 kg**

**Asta di sostegno 180 kg**

**Varilla de soporte 180 kg**

E99510-02

Right

MC 105336 n°01 piece

E99510-02

Destro

E99510-02

Derecha



E99511-02

Left

MC 105339 n°01 piece

E99511-02

Sinistro

E99511-02

Izquierda



**Alarm contact**

**Contatto allarme**

**Contacto de alarma**

K99062

MC 200906 n°01 piece  
MC 473010 n°01 piece

K99062

K99062

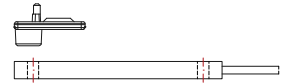

**Basic kits for side hung windows**

**Kit base per finestre battenti**

**Kits básicos para ventana batiente**

K88043

Standard windows

LBB = 465 - 1400 mm  
HBB = 455 - 2800 mm

MC 222201 n°01 piece  
MC 357081 n°01 piece  
MC 364310 n°01 piece

K88043

Finestre standard

LBB = 465 - 1400 mm  
HBB = 455 - 2800 mm

K88043

Ventanas estándar

LBB = 465 - 1400 mm  
HBB = 455 - 2800 mm



K88044

LBB = 370 - 464 mm  
HBB = 455 - 2800 mm

MC 222203 n°01 piece  
MC 357081 n°01 piece  
MC 364310 n°01 piece

K88044

LBB = 370 - 464 mm  
HBB = 455 - 2800 mm

K88044

LBB = 370 - 464 mm  
HBB = 455 - 2800 mm

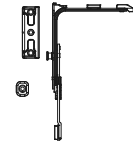

K88044

Short corner  
for low windows

LBB = 465 - 815 mm  
HBB = 370 - 454 mm

MC 222203 n°01 piece  
MC 357081 n°01 piece  
MC 364310 n°01 piece

K88044

Angolo ridotto  
per finestre basse

LBB = 465 - 815 mm  
HBB = 370 - 454 mm

K88044

Esquina corta  
para ventanas bajas

LBB = 465 - 815 mm  
HBB = 370 - 454 mm

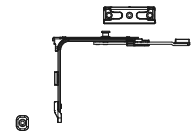

**Gear kits**

**Kit cremonese**

**Kits de equipo**

**K88003**

HH = 190 mm  
HBB = 340 - 1608 mm

MC 202206 n°01 piece  
MC 222205 n°01 piece  
MC 364310 n°01 piece

**K88003**

HH = 190 mm  
HBB = 340 - 1608 mm

**K88003**

HH = 190 mm  
HBB = 340 - 1608 mm

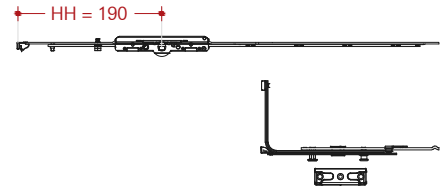

**K88004**

HH = 300 mm  
HBB = 661 - 1790 mm

MC 202207 n°01 piece  
MC 222205 n°01 piece  
MC 364310 n°02 pieces

**K88004**

HH = 300 mm  
HBB = 661 - 1790 mm

**K88004**

HH = 300 mm  
HBB = 661 - 1790 mm

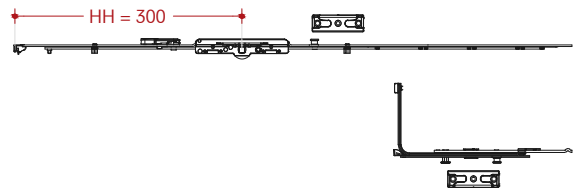

**K88005**

HH = 400 mm  
HBB = 841 - 2040 mm

MC 202208 n°01 piece  
MC 222205 n°01 piece  
MC 364310 n°02 pieces

**K88005**

HH = 400 mm  
HBB = 841 - 2040 mm

**K88005**

HH = 400 mm  
HBB = 841 - 2040 mm

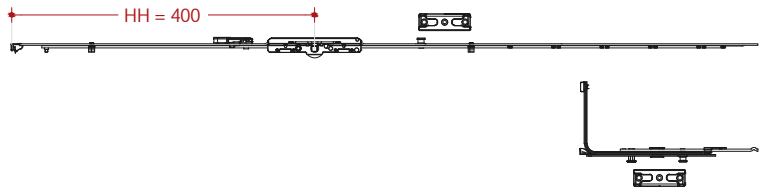

**K88006**

HH = 500 mm  
HBB = 1091 - 2290 mm

MC 202209 n°01 piece  
MC 222205 n°01 piece  
MC 364310 n°02 pieces

**K88006**

HH = 500 mm  
HBB = 1091 - 2290 mm

**K88006**

HH = 500 mm  
HBB = 1091 - 2290 mm

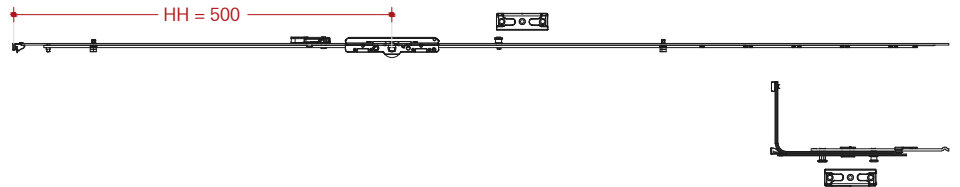

**Gear kits**

**Kit cremonese**

**Kits de equipo**

K88007

HH = 600 mm  
HBB = 1341 - 2540 mm

K88007

HH = 600 mm  
HBB = 1341 - 2540 mm

K88007

HH = 600 mm  
HBB = 1341 - 2540 mm

MC 202216 n°01 piece  
MC 222205 n°01 piece  
MC 364310 n°03 pieces

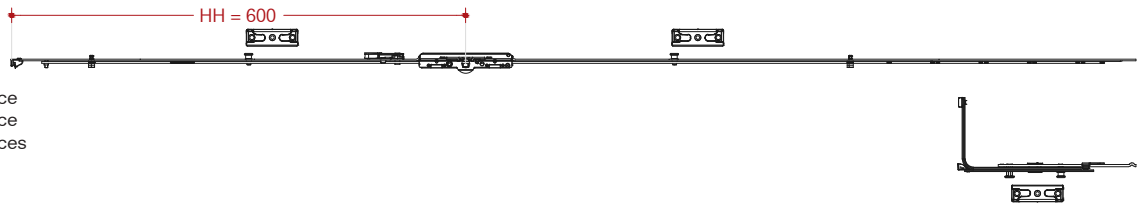

K88008

HH = 700 mm  
HBB = 1591 - 2650 mm

K88008

HH = 700 mm  
HBB = 1591 - 2650 mm

K88008

HH = 700 mm  
HBB = 1591 - 2650 mm

MC 207305 n°01 piece  
MC 222205 n°01 piece  
MC 364310 n°03 pieces

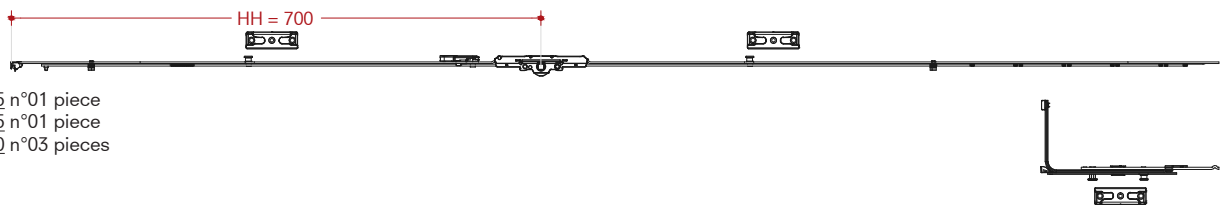

K88009

HH = 1050 mm  
HBB = 1701 - 2900 mm

K88009

HH = 1050 mm  
HBB = 1701 - 2900 mm

K88009

HH = 1050 mm  
HBB = 1701 - 2900 mm

MC 202737 n°01 piece  
MC 222205 n°01 piece  
MC 364310 n°04 pieces

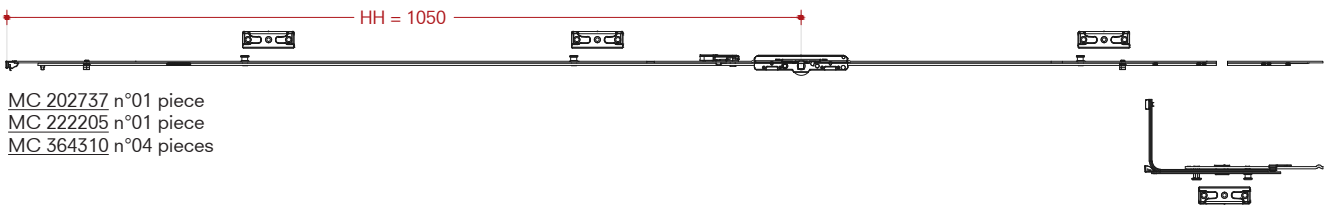

K88010

HH = 1050 mm  
HBB = 1951 - 3150 mm

K88010

HH = 1050 mm  
HBB = 1951 - 3150 mm

K88010

HH = 1050 mm  
HBB = 1951 - 3150 mm

MC 202738 n°01 piece  
MC 222205 n°01 piece  
MC 364310 n°04 pieces

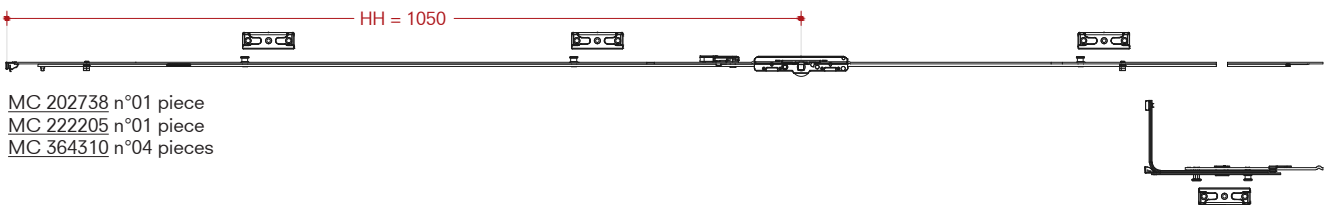



**Extension kits**

**Kit prolunga**

**Kits extensión**

K88011

0 - 140 mm

MC 206630 n°01 piece

K88011

0 - 140 mm

K88011

0 - 140 mm



K88012

141 - 235 mm

MC 201750 n°01 piece  
MC 364310 n°01 piece

K88012

141 - 235 mm

K88012

141 - 235 mm



K88059

236 - 375 mm

MC 201750 n°01 piece  
MC 206630 n°01 piece  
MC 364310 n°01 piece

K88059

236 - 375 mm

K88059

236 - 375 mm



K88013

376 - 470 mm

MC 201840 n°01 piece  
MC 364310 n°01 piece

K88013

376 - 470 mm

K88013

376 - 470 mm



**Extension kits**

**Kit prolunga**

**Kits extensión**

K88014

471 - 610 mm

MC 201840 n°01 piece  
MC 206630 n°01 piece  
MC 364310 n°01 piece

K88014

471 - 610 mm

K88014

471 - 610 mm



K88015

611 - 705 mm

MC 201750 n°01 piece  
MC 201840 n°01 piece  
MC 364310 n°02 pieces

K88015

611 - 705 mm

K88015

611 - 705 mm



K88060

706 - 845 mm

MC 206630 n°01 piece  
MC 201750 n°01 piece  
MC 201840 n°01 piece  
MC 364310 n°02 pieces

K88060

706 - 845 mm

K88060

706 - 845 mm



K88016

846 - 940 mm

MC 201840 n°02 pieces  
MC 364310 n°02 pieces

K88016

846 - 940 mm

K88016

846 - 940 mm



**Hinges kits**

**Kit cerniere**

**Kits de bisagras**

K88034

Right hinges

MC 217691 n°01 piece  
MC 217729 n°01 piece  
MC 215804 n°01 piece  
MC 215810 n°01 piece

K88034

Cerniere destre

K88034

Derecha bisagras

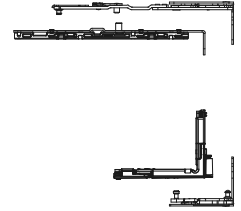

K88035

Left hinges

MC 217692 n°01 piece  
MC 217729 n°01 piece  
MC 215805 n°01 piece  
MC 215811 n°01 piece

K88035

Cerniere sinistre

K88035

Izquierda bisagras

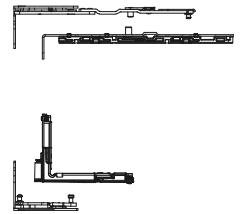

**Concealed compression locks kits**

**Kit cerniere centrali a scomparsa**

**Kits de bisagras ocultas centrales**

K88036

HBB = 1280 - 2000 mm

MC 215577 n°01 piece  
MC 365161 n°01 piece

K88036

HBB = 1280 - 2000 mm

K88036

HBB = 1280 - 2000 mm



K88037

HBB = 2001 - 2800 mm

MC 215577 n°01 piece  
MC 365161 n°01 piece

K88037

HBB = 2001 - 2800 mm

K88037

HBB = 2001 - 2800 mm

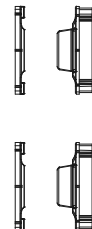

**Additional top and bottom locking point**

**Punto di chiusura aggiuntivo superiore e inferiore**

**Superior e inferior adicionales punto de bloqueo**

K88045

LBB = 801 - 1280 mm

MC 201751 n°02 pieces  
MC 364310 n°02 pieces

K88045

LBB = 801 - 1280 mm

K88045

LBB = 801 - 1280 mm

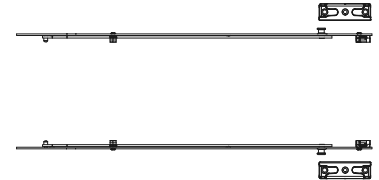

K88046

LBB = 1281 - 1400 mm

MC 201752 n°02 pieces  
MC 364310 n°02 pieces

K88046

LBB = 1281 - 1400 mm

K88046

LBB = 1281 - 1400 mm

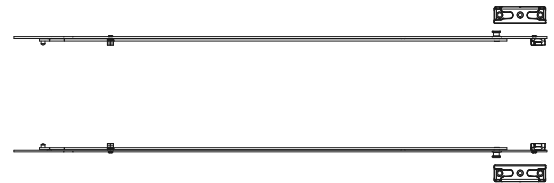

**Lifting component**

**Componente di sollevamento**

**Componente de elevación**

K88047

Right

MC 361004 n°01 piece

K88047

Destra

K88047

Derecha



K88048

Left

MC 361005 n°01 piece

K88048

Sinistra

K88048

Izquierda



**French casement lock  
extendable**

**Catenacci angolari  
estendibili**

**Cerradura abatible francesa  
extensible**

K88038

LBB = 370 - 800 mm

MC 215336 n°02 pieces  
MC 364310 n°02 pieces

K88038

LBB = 370 - 800 mm

K88038

LBB = 370 - 800 mm

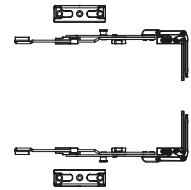

K88039

LBB = 801 - 1400 mm

MC 215336 n°02 pieces  
MC 201751 n°02 pieces  
MC 364310 n°04 pieces

K88039

LBB = 801 - 1400 mm

K88039

LBB = 801 - 1400 mm

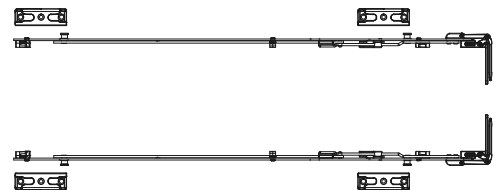

**Roller snap catch**

**Scrocco a rullo**

**Pestillo de rodillo**

K88201

MC 213461 n°02 pieces  
MC 362059 n°02 pieces  
MC 362446 n°02 pieces

K88201

K88201



**Extendable french casement lock +  
upper roller snap catch**

**Serratura anta francese estensibile  
+ scrocco a rullo superiore**

**Cerradura de marco francés  
extensible + cierre de presión de  
rodillo superior**

K88041

LBB = 370 - 800 mm

MC 213461 n°01 piece  
MC 362059 n°01 piece  
MC 362446 n°01 piece  
MC 215336 n°01 piece  
MC 364310 n°01 piece

K88041

LBB = 370 - 800 mm

K88041

LBB = 370 - 800 mm

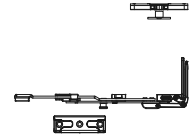

K88042

LBB = 801 - 1280 mm

MC 213461 n°01 piece  
MC 362059 n°01 piece  
MC 362446 n°01 piece  
MC 215336 n°01 piece  
MC 201751 n°01 piece  
MC 364310 n°01 piece

K88042

LBB = 801 - 1280 mm

K88042

LBB = 801 - 1280 mm

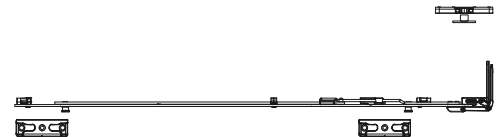

**Door catch**

**Scrocco porta**

**Pestillo de puerta**

K88061

HBB = 661 - 2800 mm

MC 201168 n°01 piece

K88061

HBB = 661 - 2800 mm

K88061

HBB = 661 - 2800 mm



**Opening restrictor**

**Limitatore di apertura**

**Limitador de apertura**

K88033

LBB = 490 - 1400 mm

MC 103623 n°01 piece

K88033

LBB = 490 - 1400 mm

K88033

LBB = 490 - 1400 mm



**Load transfer 180 kg**

**Asta di sostegno 180 kg**

**Varilla de soporte 180 kg**

E99510-02

Right

MC 105336 n°01 piece

E99510-02

Destro

E99510-02

Derecha



E99511-02

Left

MC 105339 n°01 piece

E99511-02

Sinistro

E99511-02

Izquierda



**Alarm contact**

**Contatto allarme**

**Contacto de alarma**

K99062

MC 200906 n°01 piece  
MC 473010 n°01 piece

K99062

K99062

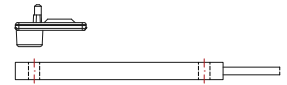

**Kits for bottom hung windows**

**Kit per finestre vasistas**

**Kits para ventana oscilante**

**Gear kits**

**Kit cremonese**

**Kits de equipo**

K88049

LBB = 390 - 500 mm

MC 208323 n°01 piece  
MC 364310 n°02 pieces

K88049

LBB = 390 - 500 mm

K88049

LBB = 390 - 500 mm

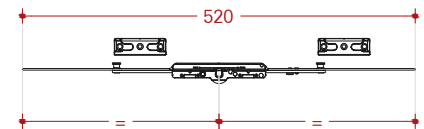

K88050

LBB = 501 - 700 mm

MC 208324 n°01 piece  
MC 364310 n°02 pieces

K88050

LBB = 501 - 700 mm

K88050

LBB = 501 - 700 mm

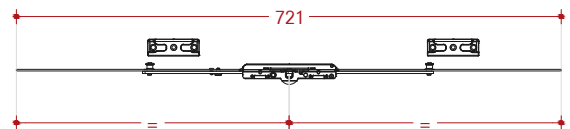

K88051

LBB = 701 - 1000 mm

MC 208325 n°01 piece  
MC 364310 n°02 pieces

K88051

LBB = 701 - 1000 mm

K88051

LBB = 701 - 1000 mm

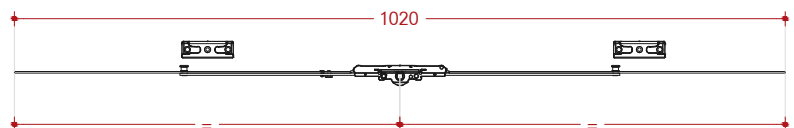



**Gear kits**

**Kit cremonese**

**Kits de equipo**

K88052

LBB = 1001 - 1400 mm

MC 208326 n°01 piece  
MC 364310 n°03 pieces

K88052

LBB = 1001 - 1400 mm

K88052

LBB = 1001 - 1400 mm

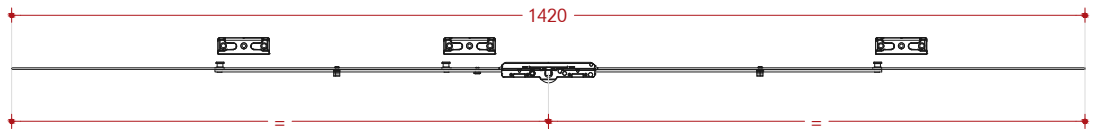

K88053

LBB = 1401 - 1800 mm

MC 208327 n°01 piece  
MC 364310 n°03 pieces

K88053

LBB = 1401 - 1800 mm

K88053

LBB = 1401 - 1800 mm

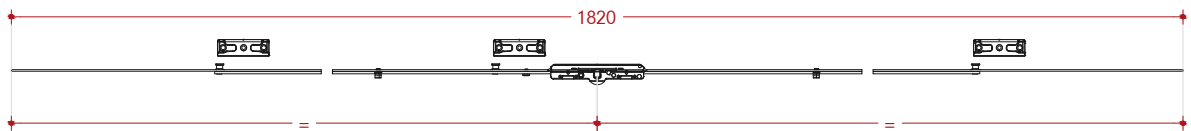

K88054

LBB = 1801 - 2250 mm

MC 202497 n°01 piece  
MC 212211 n°02 pieces  
MC 364310 n°05 pieces

K88054

LBB = 1801 - 2250 mm

K88054

LBB = 1801 - 2250 mm

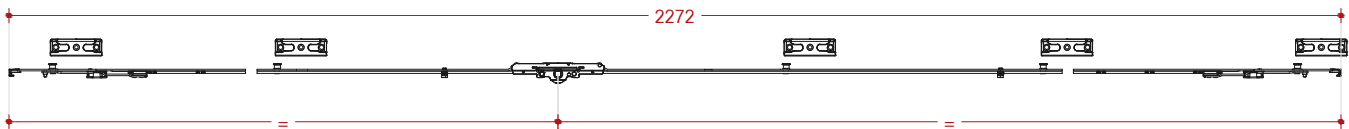

**Hinges kits**

**Kit cerniere**

**Kits de bisagras**

K88055

LBB = 390 - 1000 mm

MC 217723 n°01 piece  
MC 217724 n°01 piece  
MC 217729 n°02 pieces

K88055

LBB = 390 - 1000 mm

K88055

LBB = 390 - 1000 mm

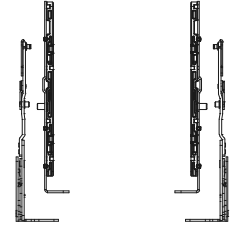

K88056

LBB = 1001 - 1400 mm

MC 215577 n°01 piece  
MC 365161 n°01 piece  
MC 217723 n°01 piece  
MC 217724 n°01 piece  
MC 217729 n°02 pieces

K88056

LBB = 1001 - 1400 mm

K88056

LBB = 1001 - 1400 mm

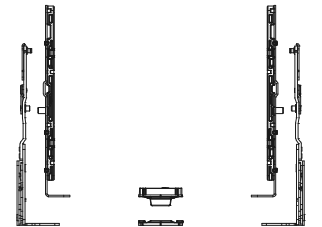

K88057

LBB = 1401 - 1800 mm

MC 215577 n°02 pieces  
MC 365161 n°02 pieces  
MC 217723 n°01 piece  
MC 217724 n°01 piece  
MC 217729 n°02 pieces

K88057

LBB = 1401 - 1800 mm

K88057

LBB = 1401 - 1800 mm

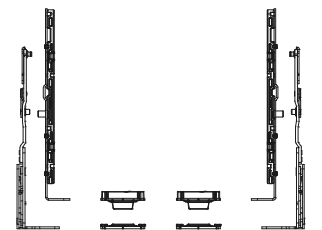

K88058

LBB = 1801 - 2250 mm

MC 215577 n°03 pieces  
MC 365161 n°03 pieces  
MC 217723 n°01 piece  
MC 217724 n°01 piece  
MC 217729 n°02 pieces

K88058

LBB = 1801 - 2250 mm

K88058

LBB = 1801 - 2250 mm

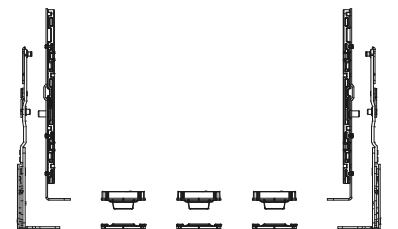

**Opening restrictor**

**Limitatore di apertura**

**Limitador de apertura**

E99205-05

With clicks.  
HBB = 400 - 1200 mm

n°02 pieces

E99205-05

Con scatti.  
HBB = 400 - 1200 mm

n°02 pezzi

E99205-05

Con clics.  
HBB = 400 - 1200 mm

n°02 unidades



E99206-03

HBB = 400 - 1200 mm

n°02 pieces

E99206-03

HBB = 400 - 1200 mm

n°02 pezzi

E99206-03

HBB = 400 - 1200 mm

n°02 unidades



K88107

HBB = 300 - 500 mm

n°02 pieces

K88107

HBB = 300 - 500 mm

n°02 pezzi

K88107

HBB = 300 - 500 mm

n°02 unidades

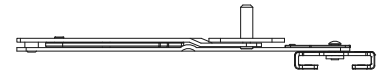

K88108

HBB = 501 - 1200 mm

n°02 pieces

K88108

HBB = 501 - 1200 mm

n°02 pezzi

K88108

HBB = 501 - 1200 mm

n°02 unidades

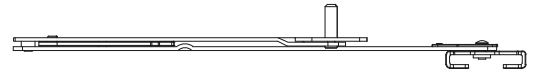

**Alarm contact**

**Contatto allarme**

**Contacto de alarma**

K99062

MC 200906 n°01 piece  
MC 473010 n°01 piece

K99062

K99062

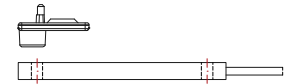

# METALFORM

MASTERS OF METAL

UNITED KINGDOM

METALFORM

NORWAYMETAL LTD

53 Chelsea Manor Street

London, SW3 5RZ

[SALES@METALFORM.UK](mailto:SALES@METALFORM.UK)

+44 20 81298814

GERMANY

METALFORM GMBH

Carl-Zeiss-Ring 15A

85737 Ismaning

[SALES@METALFORMGROUP.DE](mailto:SALES@METALFORMGROUP.DE)

+49 17663630406

NORWAY

METALFORM AS

Brochmannsveien 2

1950 Rømskog

[SALG@METALFORM.NO](mailto:SALG@METALFORM.NO)

+47 401 62 446

METALFORMGROUP

[SALES@METALFORMGROUP.COM](mailto:SALES@METALFORMGROUP.COM)