

Profile range

Gamma profili

Gama de perfiles

2.0

Profiles
Glazing beads
Glazing table

Profili
Profili fermavetro
Tabella vetrazioni

Perfiles
Junquillos
Tabla de acristalamiento

2.1
2.2
2.3

Profiles

Profili

Perfiles

2.1

Legend

+ = Fixed
— = Open in
- - - = Open out
Dimensions in: mm
Scale 1:1
G = Weight
U = Coated surface

Legenda

+ = Anta fissa
— = Apertura interna
- - - = Apertura esterna
Misure in: mm
Scala 1:1
G = Peso
U = Superficie in vista

Leyenda

+ = Fijo
— = Apertura interna
- - - = Apertura externa
Medidas en: mm
Escala 1:1
G = Peso
U = Superficie recubierta

Profiles

BAR LENGTH: 5800 mm
MATERIALS:
02 - Galvanized steel
05 - Stainless steel AISI 316L 2B
07 - Cor-Ten steel
12 - Bright steel

Profili

LUNGHEZZA BARRA: 5800 mm
MATERIALI:
02 - Acciaio zincato
05 - Acciaio inox AISI 316L 2B
07 - Acciaio Cor-Ten
12 - Acciaio decapato

Perfiles

LONGITUD DE LA BARRA: 5800 mm
MATERIALES:
02 - Acero galvanizado
05 - Acero inoxidable AISI 316L 2B
07 - Acero Cor-Ten
12 - Acero bruto

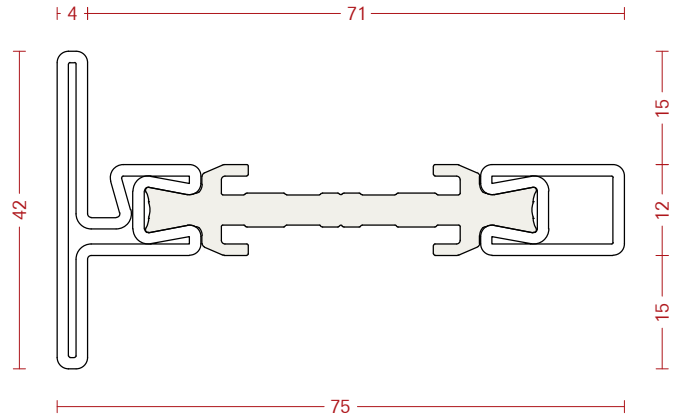
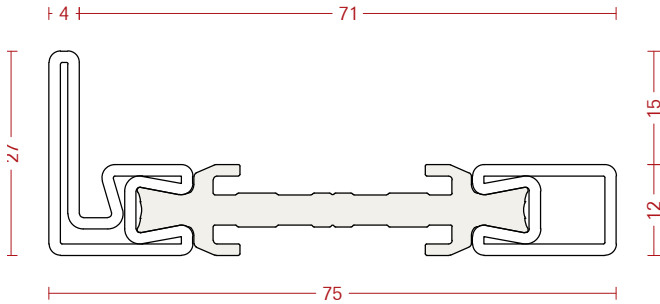
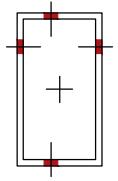

Profile	Material	G	U
FT 7512L-nn	-02	G = 2.50	U = 0.264
	-05	G = 2.54	U = 0.264
	-07	G = 2.50	U = 0.264
	-12	G = 2.50	U = 0.264
		kg/m	m ² /m

Profile	Material	G	U
FT 7512T-nn	-02	G = 2.84	U = 0.293
	-05	G = 2.88	U = 0.293
	-07	G = 2.84	U = 0.293
	-12	G = 2.84	U = 0.293
		kg/m	m ² /m

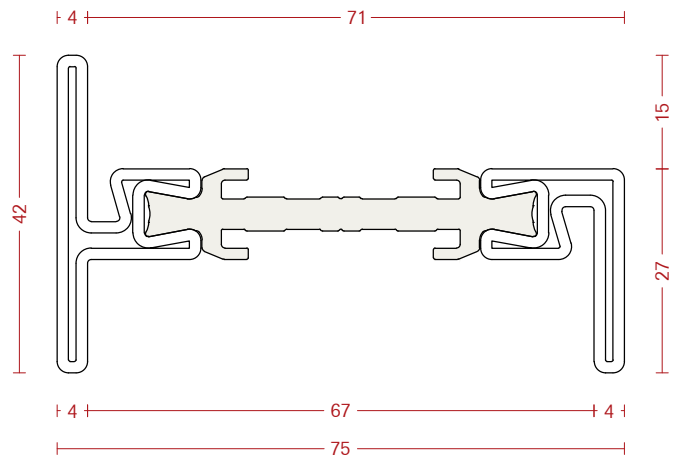
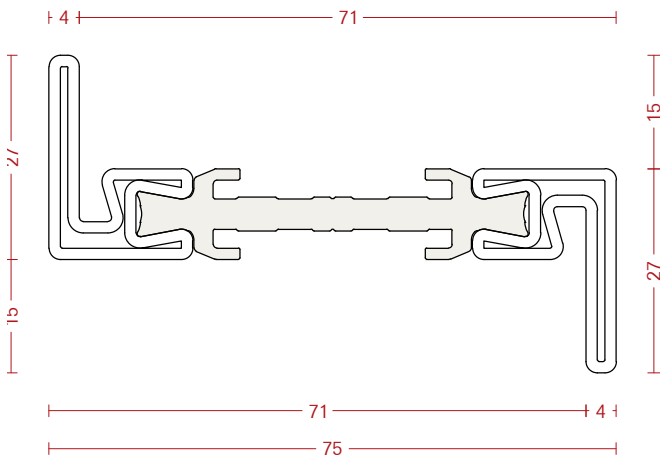

Profile	Material	G	U
FT 7512Z-nn	-02	G = 3.00	U = 0.307
	-05	G = 3.05	U = 0.307
	-07	G = 3.00	U = 0.307
	-12	G = 3.00	U = 0.307
		kg/m	m ² /m

Profile	Material	G	U
FT 7512H-nn	-02	G = 3.34	U = 0.337
	-05	G = 3.40	U = 0.337
	-07	G = 3.34	U = 0.337
	-12	G = 3.34	U = 0.337
		kg/m	m ² /m

Profiles

BAR LENGTH: 5800 mm
MATERIALS:
02 - Galvanized steel
05 - Stainless steel AISI 316L 2B
07 - Cor-Ten steel
12 - Bright steel

Profili

LUNGHEZZA BARRA: 5800 mm
MATERIALI:
02 - Acciaio zincato
05 - Acciaio inox AISI 316L 2B
07 - Acciaio Cor-Ten
12 - Acciaio decapato

Perfiles

LONGITUD DE LA BARRA: 5800 mm
MATERIALES:
02 - Acero galvanizado
05 - Acero inoxidable AISI 316L 2B
07 - Acero Cor-Ten
12 - Acero bruto

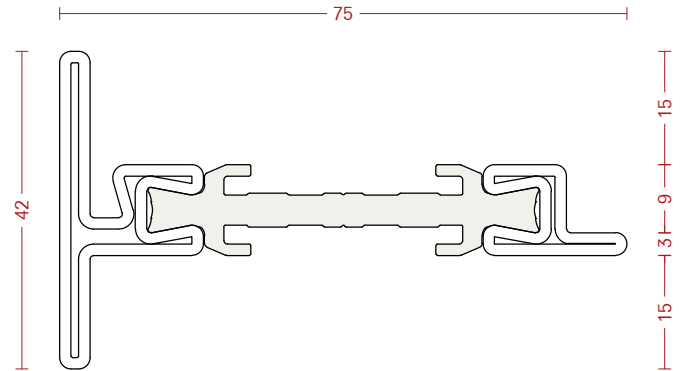
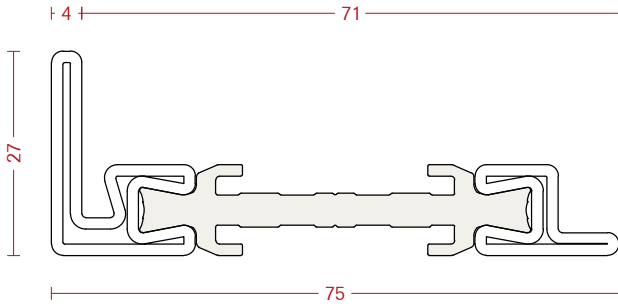
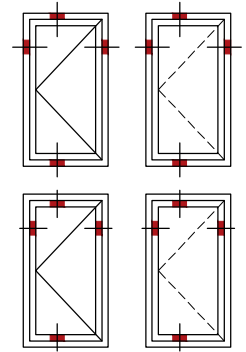

FT 7512LK-nn	-02	G = 2.48	U = 0.263
	-05	G = 2.52	U = 0.263
	-07	G = 2.48	U = 0.263
	-12	G = 2.48	U = 0.263
		kg/m	m ² /m

FT 7512TK-nn	-02	G = 2.74	U = 0.292
	-05	G = 2.78	U = 0.292
	-07	G = 2.74	U = 0.292
	-12	G = 2.74	U = 0.292
		kg/m	m ² /m

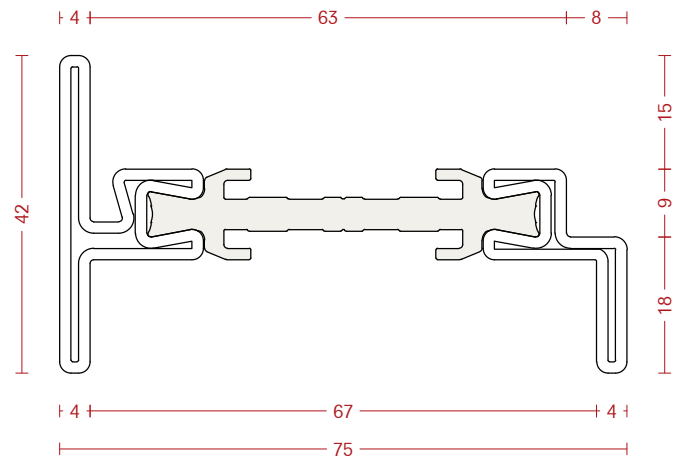
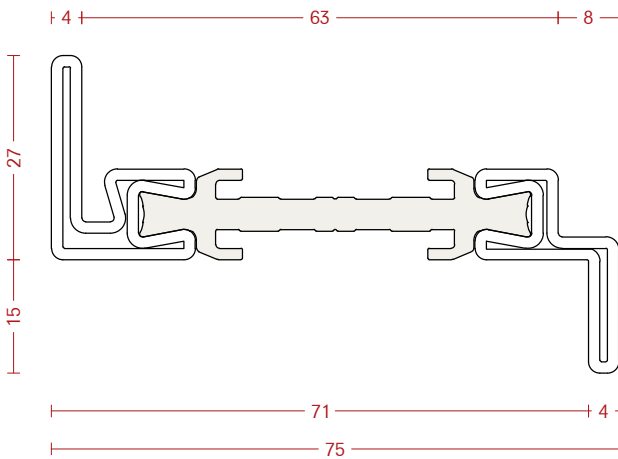

FT 7512ZK-nn	-02	G = 2.74	U = 0.261
	-05	G = 2.78	U = 0.261
	-07	G = 2.74	U = 0.261
	-12	G = 2.74	U = 0.261
		kg/m	m ² /m

FT 7512HK-nn	-02	G = 3.16	U = 0.321
	-05	G = 3.21	U = 0.321
	-07	G = 3.16	U = 0.321
	-12	G = 3.16	U = 0.321
		kg/m	m ² /m

Profiles

BAR LENGTH: 5800 mm
MATERIALS:
02 - Galvanized steel
05 - Stainless steel AISI 316L 2B
07 - Cor-Ten steel
12 - Bright steel

Profili

LUNGHEZZA BARRA: 5800 mm
MATERIALI:
02 - Acciaio zincato
05 - Acciaio inox AISI 316L 2B
07 - Acciaio Cor-Ten
12 - Acciaio decapato

Perfiles

LONGITUD DE LA BARRA: 5800 mm
MATERIALES:
02 - Acero galvanizado
05 - Acero inoxidable AISI 316L 2B
07 - Acero Cor-Ten
12 - Acero bruto

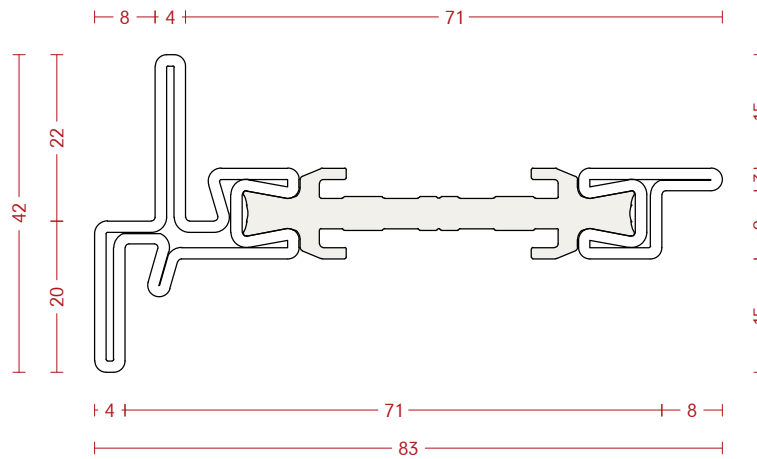
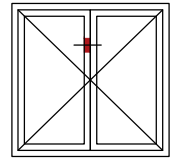

FT 8312TZ-nn	-02	G = 3.16	U = 0.320
	-05	G = 3.21	U = 0.320
	-07	G = 3.16	U = 0.320
	-12	G = 3.16	U = 0.320
		kg/m	m ² /m

Profiles

BAR LENGTH: 5800 mm

MATERIALS:

- 02 - Galvanized steel
- 05 - Stainless steel AISI 316L 2B
- 07 - Cor-Ten steel
- 12 - Bright steel

Profili

LUNGHEZZA BARRA: 5800 mm

MATERIALI:

- 02 - Acciaio zincato
- 05 - Acciaio inox AISI 316L 2B
- 07 - Acciaio Cor-Ten
- 12 - Acciaio decapato

Perfiles

LONGITUD DE LA BARRA: 5800 mm

MATERIALES:

- 02 - Acero galvanizado
- 05 - Acero inoxidable AISI 316L 2B
- 07 - Acero Cor-Ten
- 12 - Acero bruto

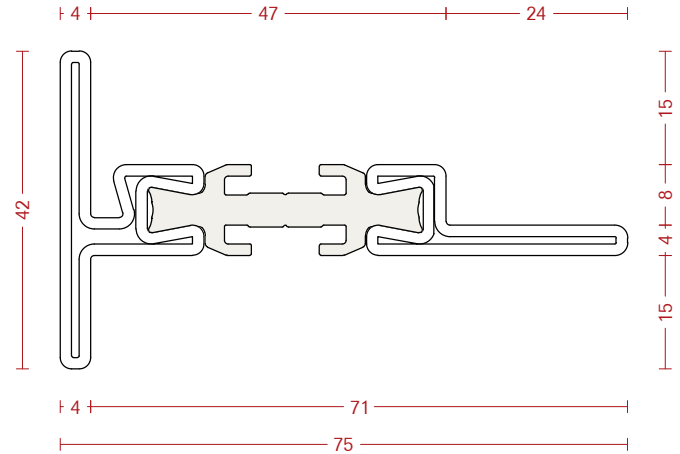
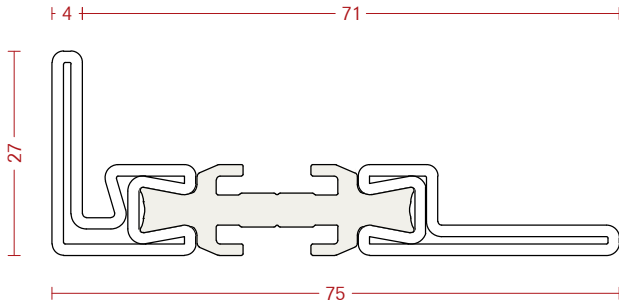
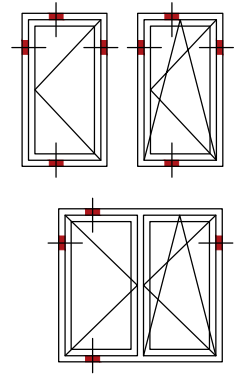

FT 7512LR-nn	-02	G = 2.77	U = 0.320
	-05	G = 2.81	U = 0.320
	-07	G = 2.77	U = 0.320
	-12	G = 2.77	U = 0.320
		kg/m	m ² /m

FT 7512TR-nn	-02	G = 3.10	U = 0.291
	-05	G = 3.16	U = 0.291
	-07	G = 3.10	U = 0.291
	-12	G = 3.10	U = 0.291
		kg/m	m ² /m

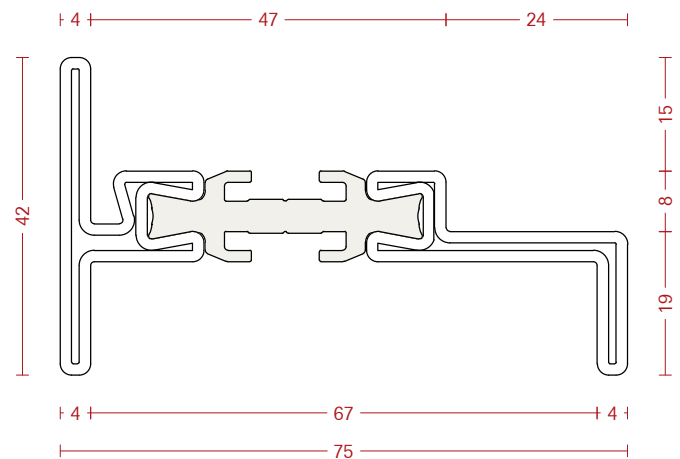
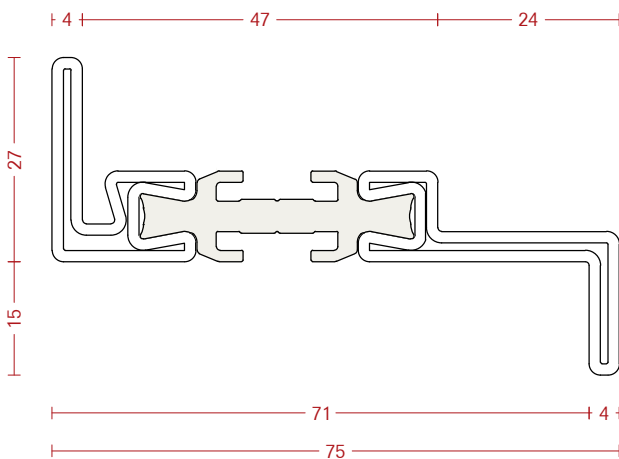

FT 7512ZR-nn	-02	G = 3.10	U = 0.291
	-05	G = 3.16	U = 0.291
	-07	G = 3.10	U = 0.291
	-12	G = 3.10	U = 0.291
		kg/m	m ² /m

FT 7512HR-nn	-02	G = 3.44	U = 0.262
	-05	G = 3.50	U = 0.262
	-07	G = 3.44	U = 0.262
	-12	G = 3.44	U = 0.262
		kg/m	m ² /m

Profiles

BAR LENGTH: 5800 mm
MATERIALS:
02 - Galvanized steel
05 - Stainless steel AISI 316L 2B
07 - Cor-Ten steel
12 - Bright steel

Profili

LUNGHEZZA BARRA: 5800 mm
MATERIALI:
02 - Acciaio zincato
05 - Acciaio inox AISI 316L 2B
07 - Acciaio Cor-Ten
12 - Acciaio decapato

Perfiles

LONGITUD DE LA BARRA: 5800 mm
MATERIALES:
02 - Acero galvanizado
05 - Acero inoxidable AISI 316L 2B
07 - Acero Cor-Ten
12 - Acero bruto

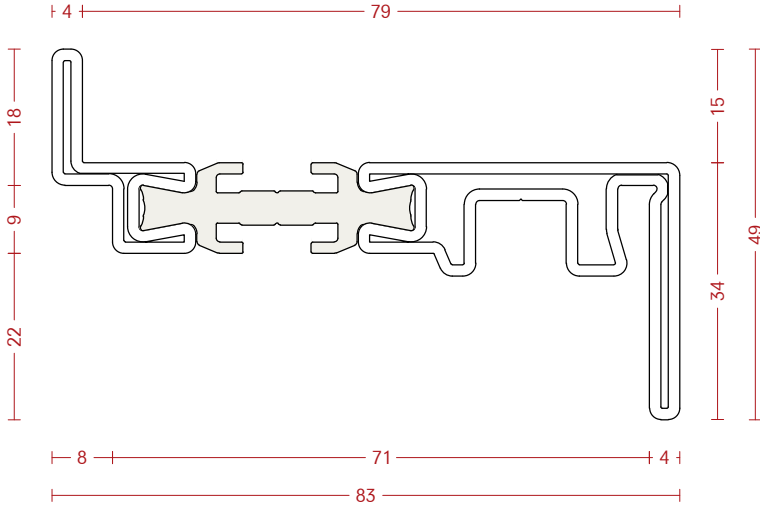
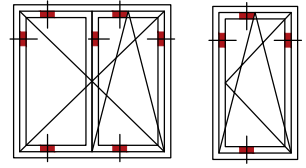

FT 8312ZR-nn	-02	G = 3.77	U = 0.349
	-05	G = 3.84	U = 0.349
	-07	G = 3.77	U = 0.349
	-12	G = 3.77	U = 0.349
		kg/m	m ² /m

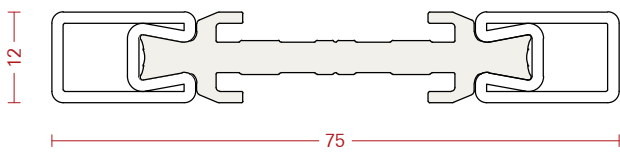
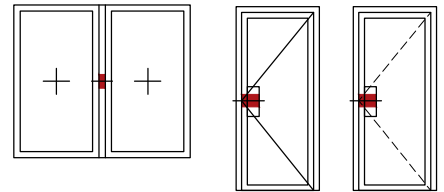

FT 7512PU-nn	-02	G = 1.99	U = 0.220
	-05	G = 2.03	U = 0.220
	-07	G = 1.99	U = 0.220
	-12	G = 1.99	U = 0.220
		kg/m	m ² /m

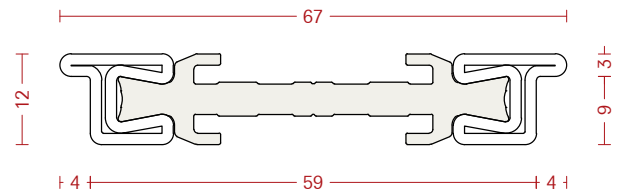

FT 6712LB-nn	-05	G = 1.71	U = 0.171
	-07	G = 1.68	U = 0.171
	-12	G = 1.68	U = 0.171
		kg/m	m ² /m

NOTE:

FT 6712LB-05 can be used with galvanized steel (-02) and stainless steel (-05) profiles; FT 6712LB-07 can be used with Cor-Ten steel profiles (-07); FT 6712LB-12 can be used with galvanized steel (-02) and bright steel (-12) profiles.

NOTA:

FT 6712LB-05 è utilizzabile con profili in acciaio zincato (-02) e acciaio inox (-05); FT 6712LB-07 è utilizzabile con profili in acciaio Cor-Ten (-07); FT 6712LB-12 è utilizzabile con profili in acciaio zincato (-02) e acciaio decapato (-12).

NOTA:

FT 6712LB-05 se puede utilizar con perfiles de acero galvanizado (-02) y acero inoxidable (-05); FT 6712LB-07 se puede utilizar con perfiles de acero Cor-Ten (-07); FT 6712LB-12 se puede utilizar con perfiles de acero galvanizado (-02) acero bruto (-12).

Profiles

BAR LENGTH: 5800 mm
MATERIALS:
02 - Galvanized steel
05 - Stainless steel AISI 316L 2B
07 - Cor-Ten steel
12 - Bright steel

Profili

LUNGHEZZA BARRA: 5800 mm
MATERIALI:
02 - Acciaio zincato
05 - Acciaio inox AISI 316L 2B
07 - Acciaio Cor-Ten
12 - Acciaio decapato

Perfiles

LONGITUD DE LA BARRA: 5800 mm
MATERIALES:
02 - Acero galvanizado
05 - Acero inoxidable AISI 316L 2B
07 - Acero Cor-Ten
12 - Acero bruto

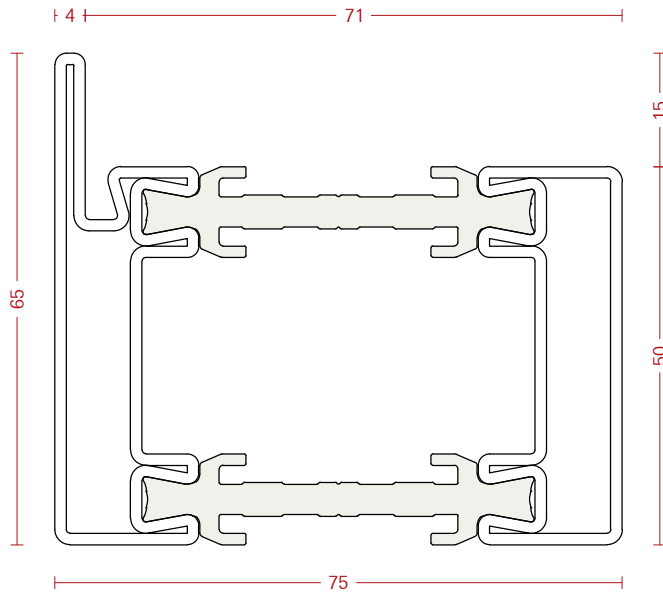
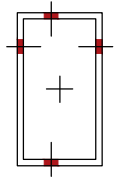

FT 7550LF-nn	-02	G = 5.30	U = 0.339
	-05	G = 5.39	U = 0.339
	-07	G = 5.30	U = 0.339
	-12	G = 5.30	U = 0.339
		kg/m	m ² /m

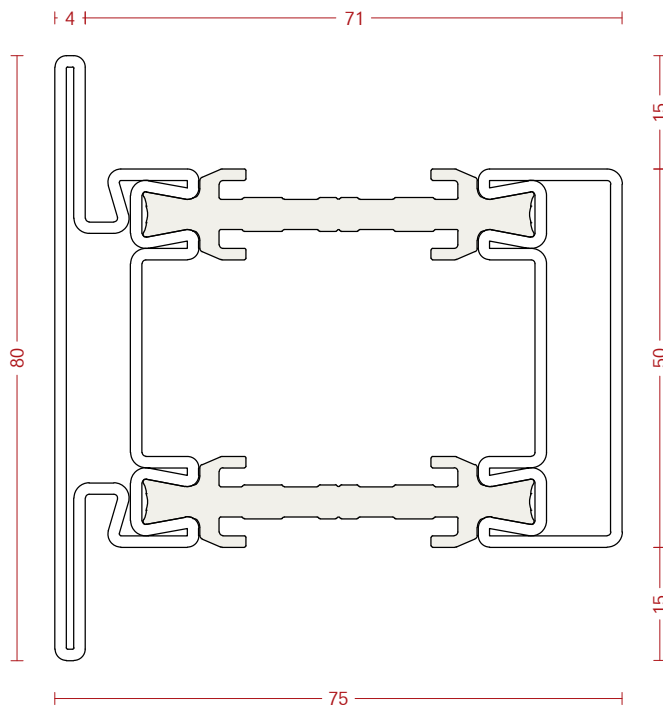

FT 7550TF-nn	-02	G = 5.80	U = 0.383
	-05	G = 5.90	U = 0.383
	-07	G = 5.80	U = 0.383
	-12	G = 5.80	U = 0.383
		kg/m	m ² /m

Profiles

BAR LENGTH: 5800 mm
MATERIALS:
02 - Galvanized steel
05 - Stainless steel AISI 316L 2B
07 - Cor-Ten steel
12 - Bright steel

Profili

LUNGHEZZA BARRA: 5800 mm
MATERIALI:
02 - Acciaio zincato
05 - Acciaio inox AISI 316L 2B
07 - Acciaio Cor-Ten
12 - Acciaio decapato

Perfiles

LONGITUD DE LA BARRA: 5800 mm
MATERIALES:
02 - Acero galvanizado
05 - Acero inoxidable AISI 316L 2B
07 - Acero Cor-Ten
12 - Acero bruto

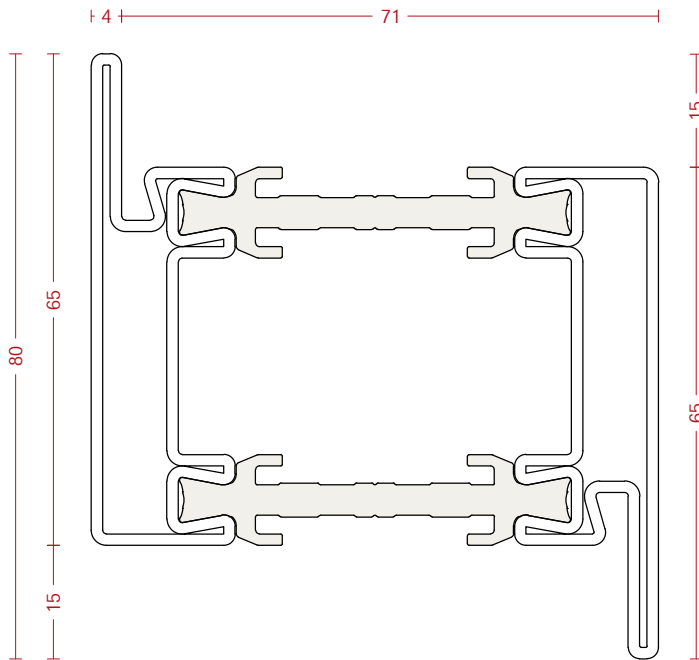
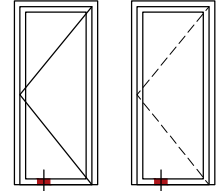
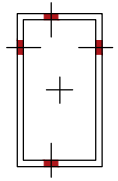

FT 7550ZF-nn

-02	G = 5.81	U = 0.383
-05	G = 5.90	U = 0.383
-07	G = 5.81	U = 0.383
-12	G = 5.81	U = 0.383
	kg/m	m ² /m

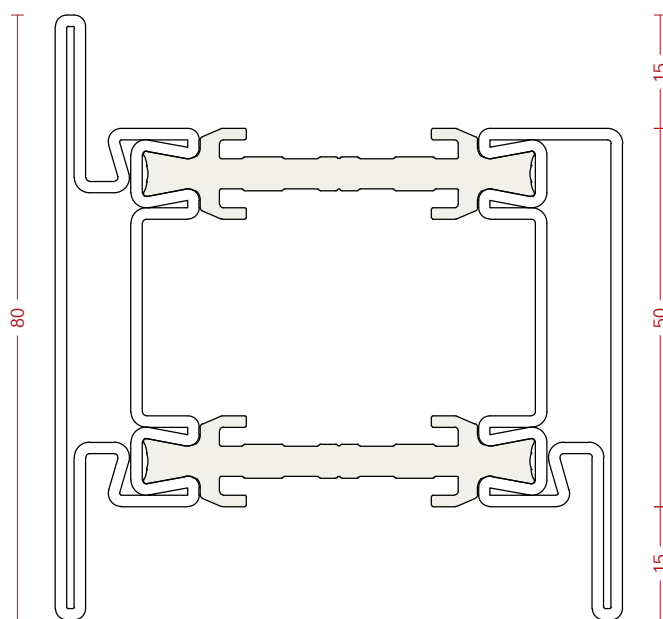
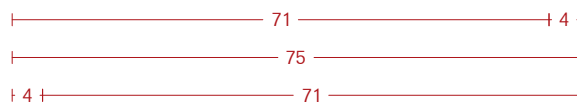

FT 7550HF-nn

-02	G = 6.31	U = 0.427
-05	G = 6.31	U = 0.427
-07	G = 6.41	U = 0.427
-12	G = 6.31	U = 0.427
	kg/m	m ² /m



Profiles

BAR LENGTH: 5800 mm
MATERIALS:
02 - Galvanized steel
05 - Stainless steel AISI 316L 2B
07 - Cor-Ten steel
12 - Bright steel

Profili

LUNGHEZZA BARRA: 5800 mm
MATERIALI:
02 - Acciaio zincato
05 - Acciaio inox AISI 316L 2B
07 - Acciaio Cor-Ten
12 - Acciaio decapato

Perfiles

LONGITUD DE LA BARRA: 5800 mm
MATERIALES:
02 - Acero galvanizado
05 - Acero inoxidable AISI 316L 2B
07 - Acero Cor-Ten
12 - Acero bruto

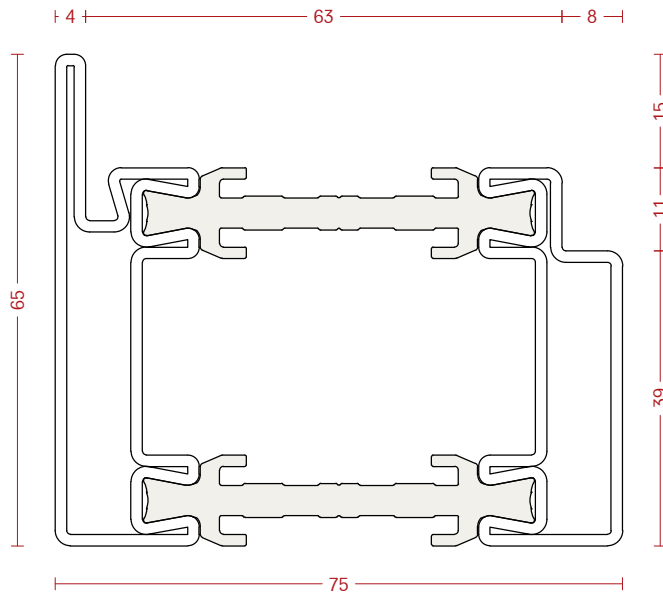
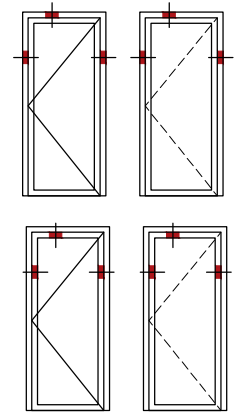

FT 7550L-nn

-02	G = 5.28	U = 0.338
-05	G = 5.37	U = 0.338
-07	G = 5.28	U = 0.338
-12	G = 5.28	U = 0.338
	kg/m	m ² /m

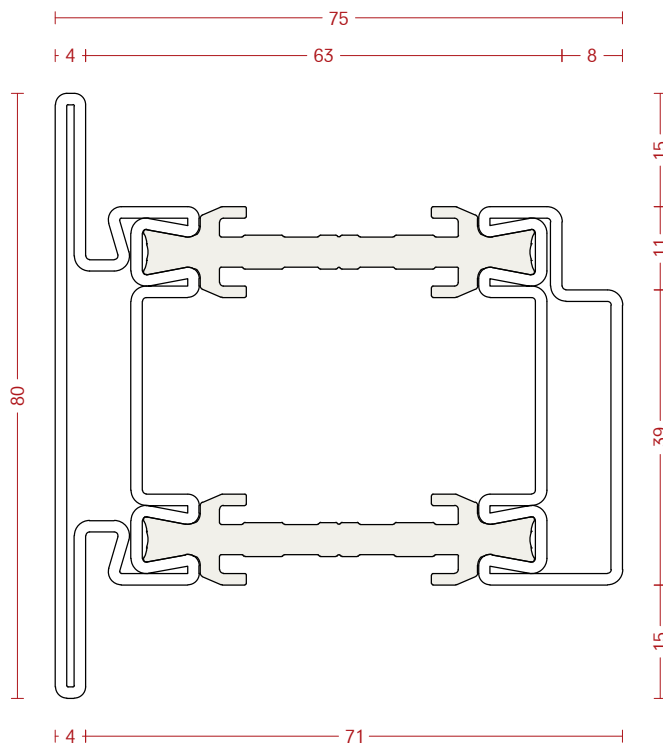

FT 7550T-nn

-02	G = 5.78	U = 0.382
-05	G = 5.88	U = 0.382
-07	G = 5.78	U = 0.382
-12	G = 5.78	U = 0.382
	kg/m	m ² /m

Profiles

BAR LENGTH: 5800 mm
MATERIALS:
02 - Galvanized steel
05 - Stainless steel AISI 316L 2B
07 - Cor-Ten steel
12 - Bright steel

Profili

LUNGHEZZA BARRA: 5800 mm
MATERIALI:
02 - Acciaio zincato
05 - Acciaio inox AISI 316L 2B
07 - Acciaio Cor-Ten
12 - Acciaio decapato

Perfiles

LONGITUD DE LA BARRA: 5800 mm
MATERIALES:
02 - Acero galvanizado
05 - Acero inoxidable AISI 316L 2B
07 - Acero Cor-Ten
12 - Acero bruto

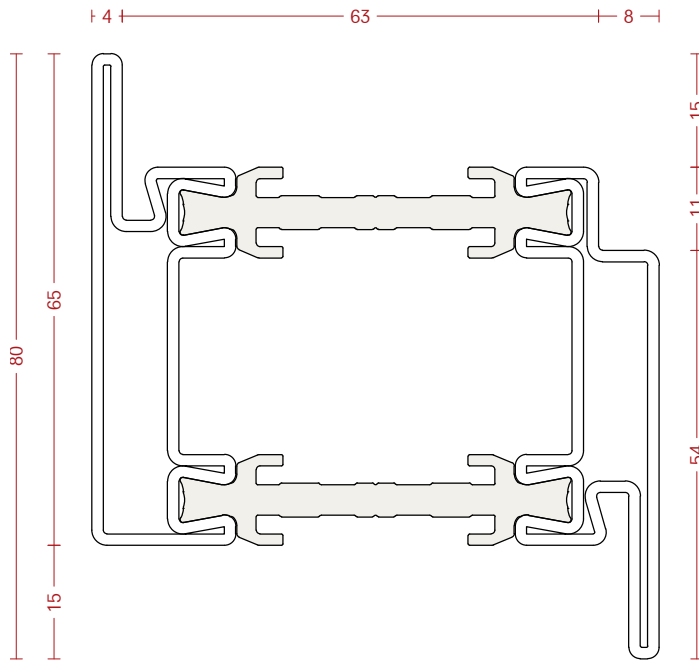
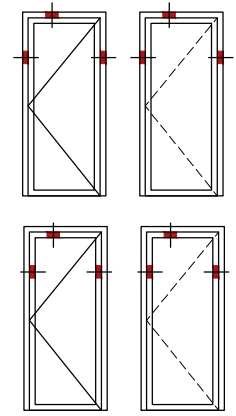

FT 7550Z-nn

-02	G = 5.79	U = 0.382
-05	G = 5.89	U = 0.382
-07	G = 5.79	U = 0.382
-12	G = 5.79	U = 0.382
	kg/m	m ² /m

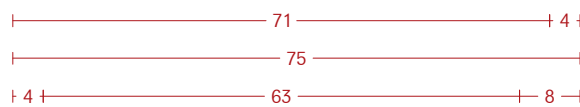

FT 7550H-nn

-02	G = 6.29	U = 0.426
-05	G = 6.39	U = 0.426
-07	G = 6.29	U = 0.426
-12	G = 6.29	U = 0.426
	kg/m	m ² /m

Profiles

BAR LENGTH: 5800 mm
MATERIALS:
02 - Galvanized steel
05 - Stainless steel AISI 316L 2B
07 - Cor-Ten steel
12 - Bright steel

Profili

LUNGHEZZA BARRA: 5800 mm
MATERIALI:
02 - Acciaio zincato
05 - Acciaio inox AISI 316L 2B
07 - Acciaio Cor-Ten
12 - Acciaio decapato

Perfiles

LONGITUD DE LA BARRA: 5800 mm
MATERIALES:
02 - Acero galvanizado
05 - Acero inoxidable AISI 316L 2B
07 - Acero Cor-Ten
12 - Acero bruto

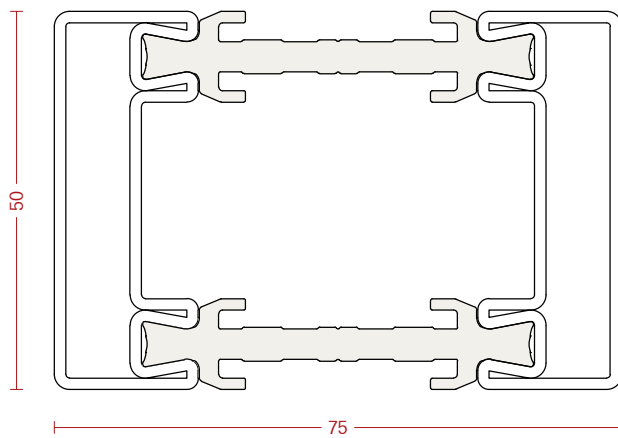
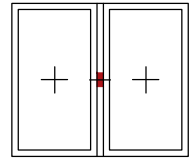







FT 7550PU-nn

-02	G = 4.80	U = 0.295
-05	G = 4.88	U = 0.295
-07	G = 4.80	U = 0.295
-12	G = 4.80	U = 0.295
	kg/m	m ² /m

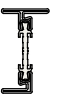
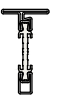
Inertia values
according to EN14024

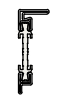
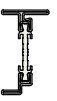
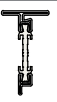
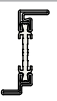
Valori di inerzia
conforme a norma EN14024

Valores de inercia
conforme a EN14024

		ly (cm ⁴)	Wy (cm ³)	Ix (cm ⁴) SPAN L1	Ix (cm ⁴) SPAN L2	Ix (cm ⁴) SPAN L3	Wx (cm ³) SPAN L1	Wx (cm ³) SPAN L2	Wx (cm ³) SPAN L3
FT 7512L-nn		1.182	0.629	14.060	18.230	20.300	3.083	3.998	4.452
FT 7512H-nn		3.057	1.353	19.560	27.310	31.640	4.713	6.581	7.624
FT 7512T-nn		2.233	1.063	15.340	20.190	22.650	3.105	4.087	4.585
FT 7512Z-nn		2.233	1.063	17.830	24.360	27.870	4.755	6.496	7.432
FT 7512LK-nn		1.202	0.626	13.350	17.290	19.250	2.883	3.734	4.158
FT 7512HK-nn		2.991	1.300	18.130	24.860	28.510	4.111	5.637	6.465
FT 7512TK-nn		2.211	1.033	14.590	19.170	21.490	2.930	3.849	4.315
FT 7512ZK-nn		2.209	1.037	16.550	22.250	25.250	4.127	5.549	6.297
FT 7512LR-nn		1.337	0.668	11.840	15.480	17.400	2.596	3.395	3.816
FT 7512HR-nn		3.011	1.298	17.120	23.250	26.750	3.900	5.296	6.093
FT 7512TR-nn		2.265	1.039	12.980	17.330	19.690	2.654	3.544	4.027
FT 7512ZR-nn		2.265	1.039	15.690	20.790	23.590	3.884	5.146	5.839

Legend

G = Weight
U = Coated surface
Wx / Wy = Flexural strength module
about one axis
Ix / Iy = Moment of inertia
about one axis
SPAN = profile length between
two fixtures

For any additional information
please contact our technical office.

Legenda

G = Peso
U = Superficie in vista
Wx / Wy = Modulo di resistenza alla
flessione lungo un asse
Ix / Iy = Momento d'inerzia
lungo un asse
SPAN = lunghezza del profilo
fra due fissaggi

Per ulteriori informazioni contattare
l'ufficio tecnico.









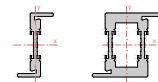



Leyenda

G = Peso
U = Superficie recubierta
Wx / Wy = Módulo de resistencia
a la flexión sobre un eje
Ix / Iy = Momento de inercia
sobre un eje
SPAN = longitud del perfil
entre dos fijaciones

Para más información contactar la
nuestra oficina técnica.

SPAN L1 2500 mm
SPAN L2 4000 mm
SPAN L3 5800 mm



	I_y (cm ⁴)	W_y (cm ³)	I_x (cm ⁴) SPAN L1	I_x (cm ⁴) SPAN L2	I_x (cm ⁴) SPAN L3	W_x (cm ³) SPAN L1	W_x (cm ³) SPAN L2	W_x (cm ³) SPAN L3
FT 7512PU-nn 	0.392	0.653	11.220	14.030	15.340	2.992	3.741	4.091
FT 7550L-nn 	20.374	5.492	21.570	32.620	39.800	5.185	7.841	9.567
FT 7550H-nn 	31.471	7.353	25.150	39.710	49.970	6.149	9.709	12.218
FT 7550T-nn 	26.443	6.578	22.910	35.200	43.420	5.125	7.875	9.714
FT 7550Z-nn 	26.443	6.578	23.680	36.720	45.580	6.265	9.714	12.058
FT 7550LF-nn 	20.807	5.639	22.060	33.340	40.690	5.341	8.073	9.852
FT 7550HF-nn 	32.079	7.530	25.540	40.390	50.830	6.291	9.948	12.520
FT 7550TF-nn 	26.971	6.743	23.420	35.960	44.380	5.275	8.099	9.995
FT 7550ZF-nn 	26.971	6.743	24.100	37.350	46.380	6.427	9.960	12.368
FT 7550PU-nn 	15.805	6.322	20.200	29.860	35.910	5.387	7.963	9.576
FT 6712LB-nn 	0.300	0.461	8.380	10.320	11.190	2.501	3.081	3.340
FT 8312TZ-nn 	2.346	1.102	17.180	22.600	25.390	3.176	4.177	4.693
FT 8312ZR-nn 	3.772	1.392	23.330	30.620	34.750	4.901	6.433	7.300

Legend

G = Weight
U = Coated surface
Wx / Wy = Flexural strength module about one axis
Ix / Iy = Moment of inertia about one axis
SPAN = profile length between two fixtures

For any additional information please contact our technical office.

Legenda

G = Peso
U = Superficie in vista
Wx / Wy = Modulo di resistenza alla flessione lungo un asse
Ix / Iy = Momento d'inertzia lungo un asse
SPAN = lunghezza del profilo fra due fissaggi

Per ulteriori informazioni contattare l'ufficio tecnico.

Leyenda

G = Peso
U = Superficie recubierta
Wx / Wy = Módulo de resistencia a la flexión sobre un eje
Ix / Iy = Momento de inercia sobre un eje
SPAN = longitud del perfil entre dos fijaciones

Para más información contactar la nuestra oficina técnica.

SPAN L1 2500 mm
SPAN L2 4000 mm
SPAN L3 5800 mm

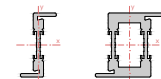

Glazing beads

Profili fermavetro

Junquillos

2.2

Legend

+ = Fixed
— = Open in
- - - = Open out
Dimensions in: mm
Scale 1:1
G = Weight
U = Coated surface

Legenda

+ = Anta fissa
— = Apertura interna
- - - = Apertura esterna
Misure in: mm
Scala 1:1
G = Peso
U = Superficie in vista

Leyenda

+ = Fijo
— = Apertura interna
- - - = Apertura externa
Medidas en: mm
Escala 1:1
G = Peso
U = Superficie recubierta

Glazing beads

BAR LENGTH: 5800 mm
MATERIALS:
02 - Galvanized steel
05 - Stainless steel AISI 316L 2B
07 - Cor-Ten steel
12 - Bright steel

Fermavetri

LUNGHEZZA BARRA: 5800 mm
MATERIALI:
02 - Acciaio zincato
05 - Acciaio inox AISI 316L 2B
07 - Acciaio Cor-Ten
12 - Acciaio decapato

Junquillos

LONGITUD DE LA BARRA: 5800 mm
MATERIALES:
02 - Acero galvanizado
05 - Acero inoxidable AISI 316L 2B
07 - Acero Cor-Ten
12 - Acero bruto

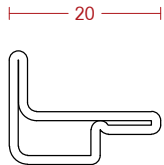
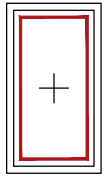

FV 1520E-nn

-02	G = 0.58	U = 0.067
-05	G = 0.59	U = 0.067
-07	G = 0.58	U = 0.067
-12	G = 0.58	U = 0.067
	kg/m	m ² /m

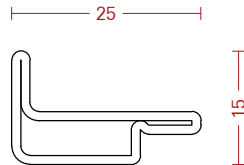

FV 1525E-nn

-02	G = 0.67	U = 0.077
-05	G = 0.69	U = 0.077
-07	G = 0.67	U = 0.077
-12	G = 0.67	U = 0.077
	kg/m	m ² /m

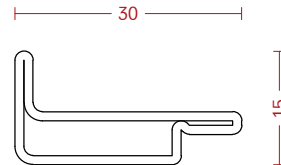

FV 1530E-nn

-02	G = 0.77	U = 0.087
-05	G = 0.78	U = 0.087
-07	G = 0.77	U = 0.087
-12	G = 0.77	U = 0.087
	kg/m	m ² /m

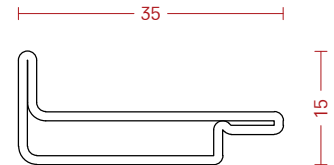

FV 1535E-nn

-02	G = 0.86	U = 0.097
-05	G = 0.88	U = 0.097
-07	G = 0.86	U = 0.097
-12	G = 0.86	U = 0.097
	kg/m	m ² /m

Fixing screw

PU: 100 pc
MATERIAL: Stainless steel A2

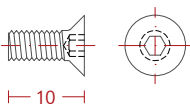

D99880-03
M4 x 10 mm

Vite di fissaggio

UV: 100 pezzi
MATERIALE: Acciaio inox A2

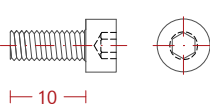

D99882-03
M4 x 10 mm

Tornillo de fijación

CANTIDAD: 100 uds.
MATERIAL: Acero inoxidable A2

Glazing beads

BAR LENGTH: 5800 mm
MATERIALS:
01 - Hot Rolled Steel
02 - Galvanized steel

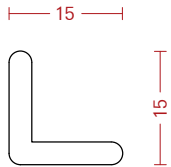

FV 1515A-02

-02 G = 0.62 U = 0.057
kg/m m²/m

Fermavetri

LUNGHEZZA BARRA: 5800 mm
MATERIALI:
01 - Acciaio laminato a caldo
02 - Acciaio zincato

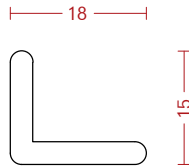

FV 1815A-02

-02 G = 0.69 U = 0.063
kg/m m²/m

Junquillos

LONGITUD DE LA BARRA: 5800 mm
MATERIALES:
01 - Acero laminado en caliente
02 - Acero galvanizado

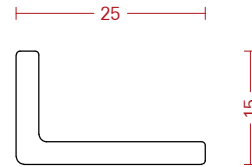

FV 1525A-01

-01 G = 0.85 U = 0.078
kg/m m²/m

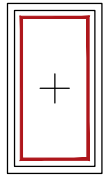

Fixing screw

PU: 100 pc
MATERIAL: Stainless steel A2

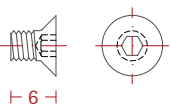

D99867-03
M4 x 6 mm

Vite di fissaggio

UV: 100 pezzi
MATERIALE: Acciaio inox A2

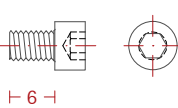

D99866-03
M4 x 6 mm

Tornillo de fijación

CANTIDAD: 100 uds.
MATERIAL: Acero inoxidable A2

Glazing beads

BAR LENGTH: 5800 mm
MATERIALS:
02 - Galvanized steel
05 - Stainless steel AISI 316L 2B
07 - Cor-Ten steel
12 - Bright steel

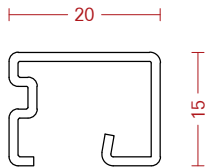

FV 1520R-nn

-02	G = 0.56	U = 0.125
-05	G = 0.57	U = 0.125
-07	G = 0.56	U = 0.125
-12	G = 0.56	U = 0.125
	kg/m	m ² /m

Fermavetri

LUNGHEZZA BARRA: 5800 mm
MATERIALI:
02 - Acciaio zincato
05 - Acciaio inox AISI 316L 2B
07 - Acciaio Cor-Ten
12 - Acciaio decapato

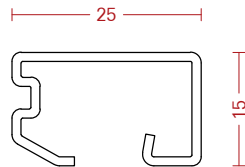

FV 1525R-nn

-02	G = 0.64	U = 0.141
-05	G = 0.69	U = 0.141
-07	G = 0.64	U = 0.141
-12	G = 0.64	U = 0.141
	kg/m	m ² /m

Junquillos

LONGITUD DE LA BARRA: 5800 mm
MATERIALES:
02 - Acero galvanizado
05 - Acero inoxidable AISI 316L 2B
07 - Acero Cor-Ten
12 - Acero bruto

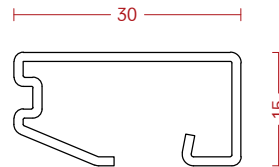

FV 1530R-nn

-02	G = 0.72	U = 0.159
-05	G = 0.73	U = 0.159
-07	G = 0.72	U = 0.159
-12	G = 0.72	U = 0.159
	kg/m	m ² /m

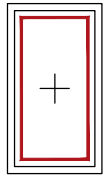

Fixing screw

PU: 100 pc
MATERIALS:
02 - Galvanized Steel
03 - Stainless steel A2

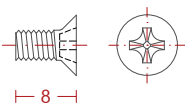

D99980-02
M4 x 8 mm
for FV15XXR-02, FV15XXR-12
per FV15XXR-02, FV15XXR-12
para FV15XXR-02, FV15XXR-12

Vite di fissaggio

UV: 100 pezzi
MATERIALI:
02 - Acciaio zincato
03 - Acciaio inox A2

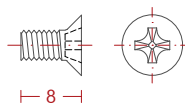

D99980-03
M4 x 8 mm
for FV15XXR-05, FV15XXR-07
per FV15XXR-05, FV15XXR-07
para FV15XXR-05, FV15XXR-07

Tornillo de fijación

CANTIDAD: 100 uds.
MATERIALES:
02 - Acero galvanizado
03 - Acero inoxidable A2

Fixing bushings

PU: 50 pc
MATERIAL: Stainless steel A2

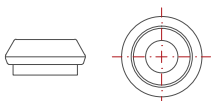

F99063-03

Boccole di fissaggio

UV: 50 pezzi
MATERIALE: Acciaio inox A2

Bujes de fijación

CANTIDAD: 50 uds.
MATERIAL: Acero inoxidable A2

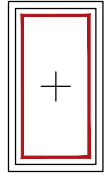

Glazing beads

BAR LENGTH: 5800 mm
MATERIALS:
02 - Galvanized steel
06 - Satin stainless steel AISI 316L
07 - Cor-Ten steel
12 - Bright steel

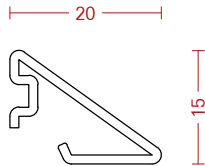

FV 1520S-nn

-02	G = 0.49	U = 0.061
-06	G = 0.50	U = 0.061
-07	G = 0.49	U = 0.061
-12	G = 0.49	U = 0.061
	kg/m	m ² /m

Fermavetri

LUNGHEZZA BARRA: 5800 mm
MATERIALI:
02 - Acciaio zincato
06 - Acciaio inox satinato AISI 316L
07 - Acciaio Cor-Ten
12 - Acciaio decapato

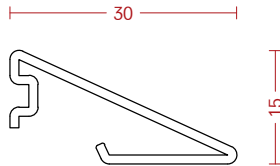

FV 1530S-nn

-02	G = 0.62	U = 0.079
-06	G = 0.63	U = 0.079
-07	G = 0.62	U = 0.079
-12	G = 0.62	U = 0.079
	kg/m	m ² /m

Junquillos

LONGITUD DE LA BARRA: 5800 mm
MATERIALES:
02 - Acero galvanizado
06 - Acero inoxidable satinado AISI 316L
07 - Acero Cor-Ten
12 - Acero bruto

Glazing bead - clips

PU: 100 pc
MATERIAL:
Stainless steel AISI 304 2B

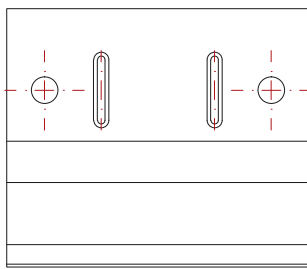

F99020-03

Fermavetri - clips

UV: 100 pezzi
MATERIALE:
Acciaio inox AISI 304 2B

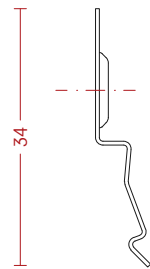

Clips para junquillos

CANTIDAD: 100 uds.
MATERIAL:
Acero inoxidable AISI 304 2B

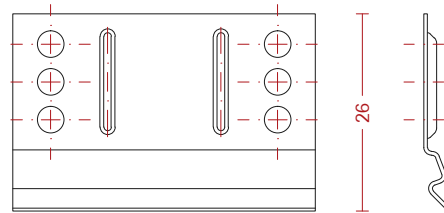

F99021-03

Compatible only with profiles FT 7512LR-nn, FT 7512TR-nn, FT 7512ZR-nn, FT 7512HR-nn and FT 8312ZR-nn
Compatibile solo con i profili FT 7512LR-nn, FT 7512TR-nn, FT 7512ZR-nn, FT 7512HR-nn e FT 8312ZR-nn
Compatible solo con perfiles FT 7512LR-nn, FT 7512TR-nn, FT 7512ZR-nn, FT 7512HR-nn y FT 8312ZR-nn

Fixture - clips

PU: 100 pc
MATERIAL: Stainless steel A2

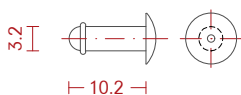

D99950-03
Ø3.2 x 8 mm

Fissaggio clips

UV: 100 pezzi
MATERIALE: Acciaio inox A2

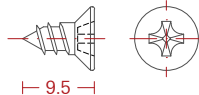

D99815-03
Ø4.2 x 9.5 mm
[See glazing table page](#)

Fijacion - clips

CANTIDAD: 100 uds.
MATERIAL: Acero inoxidable A2

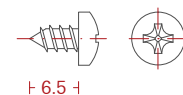

D99801-03
Ø3.5 x 6.5 mm

Glazing beads

BAR LENGTH: 5800 mm
MATERIALS:
00 - Aluminium

Suitable on galvanized steel (-02)
and bright steel (-12) profiles.

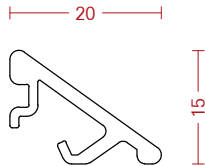

FV 1520S-00
G = 0.19 U = 0.063
kg/m m²/m

Fermavetri

LUNGHEZZA BARRA: 5800 mm
MATERIALE:
00 - Alluminio

Utilizzabile su profili in acciaio
zincato (-02) e decapato (-12).

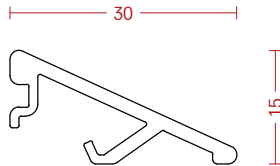

FV 1530S-00
G = 0.23 U = 0.078
kg/m m²/m

Junquillos

LONGITUD DE LA BARRA: 5800 mm
MATERIALES:
00 - Aluminio

Utilizable en perfiles en acero
galvanizado (-02) y bruto (-12).

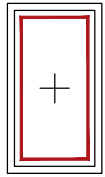

Glazing bead - clips

PU: 100 pc
MATERIAL:
Stainless steel AISI 304 2B

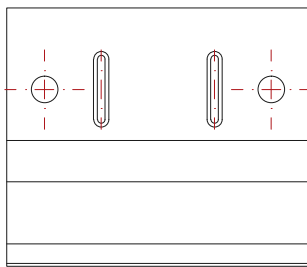

F99020-03

Fermavetri - clips

UV: 100 pezzi
MATERIALE:
Acciaio inox AISI 304 2B

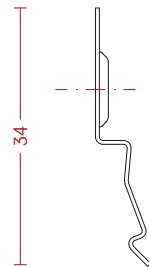

F99021-03

Clips para junquillos

CANTIDAD: 100 uds.
MATERIAL:
Acero inoxidable AISI 304 2B

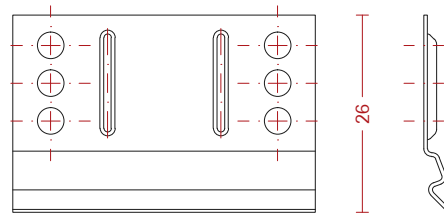

Compatible only with profiles FT 7512LR-nn, FT 7512TR-nn, FT 7512ZR-nn, FT 7512HR-nn and FT 8312ZR-nn
Compatibile solo con i profili FT 7512LR-nn, FT 7512TR-nn, FT 7512ZR-nn, FT 7512HR-nn e FT 8312ZR-nn
Compatible solo con perfiles FT 7512LR-nn, FT 7512TR-nn, FT 7512ZR-nn, FT 7512HR-nn y FT 8312ZR-nn

Fixture - clips

PU: 100 pc
MATERIAL: Stainless steel A2

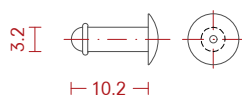

D99950-03
Ø3.2 x 8 mm

Fissaggio clips

UV: 100 pezzi
MATERIALE: Acciaio inox A2

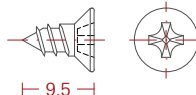

D99815-03
Ø4.2 x 9.5 mm
See glazing table page

Fijacion - clips

CANTIDAD: 100 uds.
MATERIAL: Acero inoxidable A2

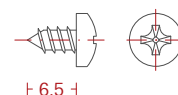

D99801-03
Ø3.5 x 6.5 mm

Glazing beads

BAR LENGTH: 5800 mm
MATERIALS:
00 - Aluminium

Suitable on galvanized steel (-02)
and bright steel (-12) profiles.

Fermavetri

LUNGHEZZA BARRA: 5800 mm
MATERIALI:
00 - Alluminio

Utilizzabile su profili in acciaio
zincato (-02) e decapato (-12).

Junquillos

LONGITUD DE LA BARRA: 5800 mm
MATERIALES:
00 - Aluminio

Utilizable en perfiles en acero
galvanizado (-02) y bruto (-12).

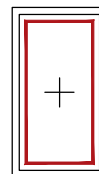

15

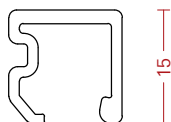

FV 1515R-00

G = 0.22 U = 0.113

kg/m m²/m

20

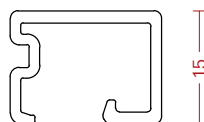

FV 1520R-00

G = 0.24 U = 0.119

kg/m m²/m

25

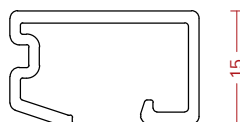

FV 1525R-00

G = 0.28 U = 0.136

kg/m m²/m

30

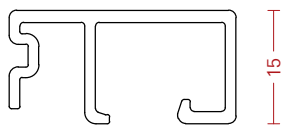

FV 1530R-00

G = 0.33 U = 0.161

kg/m m²/m

35

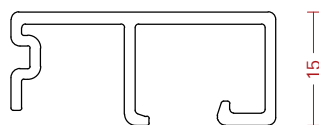

FV 1535R-00

G = 0.35 U = 0.171

kg/m m²/m

Fixing screw

PU: 100 pc
MATERIALS:
02 - Galvanized Steel
03 - Stainless steel A2

Vite di fissaggio

UV: 100 pezzi
MATERIALE:
02 - Acciaio zincato
03 - Acciaio inox A2

Tornillo de fijación

CANTIDAD: 100 uds.
MATERIALES:
02 - Acero galvanizado
03 - Acero inoxidable A2

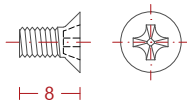

D99980-02
D99980-03
M4 x 8 mm

Fixing bushings

PU: 50 pc
MATERIAL: Stainless steel A2

Boccole di fissaggio

UV: 50 pezzi
MATERIALE: Acciaio inox A2

Bujes de fijación

CANTIDAD: 50 uds.
MATERIAL: Acero inoxidable A2

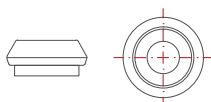

F99063-03

Glazing beads

BAR LENGTH: 5800 mm

MATERIALS:

00 - Aluminium

Suitable on galvanized steel (-02)
and bright steel (-12) profiles.

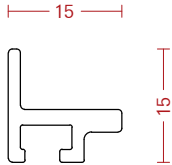

FV 1515E-00

G = 0.22 U = 0.113

kg/m m²/m

Fermavetri

LUNGHEZZA BARRA: 5800 mm

MATERIALI:

00 - Alluminio

Utilizzabile su profili in acciaio
zincato (-02) e decapato (-12).

Junquillos

LONGITUD DE LA BARRA: 5800 mm

MATERIALES:

00 - Aluminio

Utilizable en perfiles en acero
galvanizado (-02) y bruto (-12).

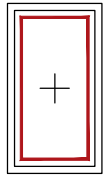

Fixing screw

PU: 100 pc

MATERIAL: Stainless steel A2

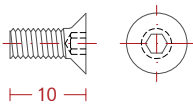

D99880-03
M4 x 10 mm

Vite di fissaggio

UV: 100 pezzi

MATERIALE: Acciaio inox A2

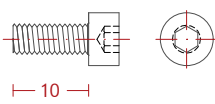

D99882-03
M4 x 10 mm

Tornillo de fijación

CANTIDAD: 100 uds.

MATERIAL: Acero inoxidable A2

Glazing table

Tabella vetrazioni

Tabla de acristalamiento

2.3

Important notes:

The glazing tables and sealing guidelines are based on the nominal sizes of the profiles and glazing. Due to the production tolerances (profiles, glazing beads, panes) we advise double checking your selection.

Note importanti:

Le tabelle vetrazioni si riferiscono alle misure nominali dei profili e delle vetrate. A causa delle tolleranze di produzione (profili, profili fermavetro, spessori) è preferibile effettuare una seconda verifica della selezione.

Notas importantes:

Las tablas de acristalamiento hacen referencia a las medidas nominales de los perfiles y los acristalamientos. Debido a las tolerancias de fabricación (perfiles, junquillos y espesores de vidrio), debe comprobarse la gama en caso necesario.

Legend

+ = Fixed
— = Open in
- - - = Open out
Dimensions in: mm
Scale 1:1
A = External gaskets
B = Internal gaskets
C = Glazing bead
D = Screw connection
E = Offset

Legenda

+ = Anta fissa
— = Apertura interna
- - - = Apertura esterna
Misure in: mm
Scala 1:1
A = Guarnizioni esterne
B = Guarnizioni interne
C = Fermavetro
D = Vite di fissaggio
E = Scarto

Leyenda

+ = Fijo
— = Apertura interna
- - - = Apertura externa
Medidas en: mm
Escala 1:1
A = Juntas exteriores
B = Juntas interiores
C = Junquillo
D = Tornillo de fijación
E = Residuos

Glazing table



Tabella vetrazioni

Tabla de acristamiento

00 - Aluminium

00 - Alluminio

00 - Aluminio

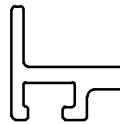
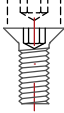
						
F	A		B		C	D
mm	code	mm	code	mm	mm	mm
46	G99103-62	5	G99204-61	5.5	15	9
47	G99103-62	5	G99203-61	4.5	15	9
48	G99102-61	3	G99204-61	5.5	15	9
49	G99102-61	3	G99203-61	4.5	15	9
50	G99102-61	3	G99202-61	3.5	15	9
51	G99102-61	3	G99201-61	2.5	15	9

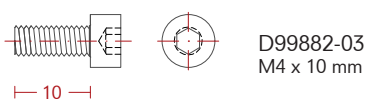
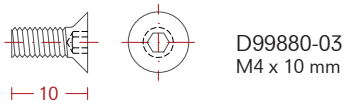
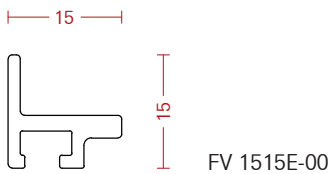

* Glazing table for 75 mm depth profiles.

* Tabella vetrazioni per profili di profondità 75 mm

* Mesa de acristamiento para perfiles de 75 mm de profundidad.

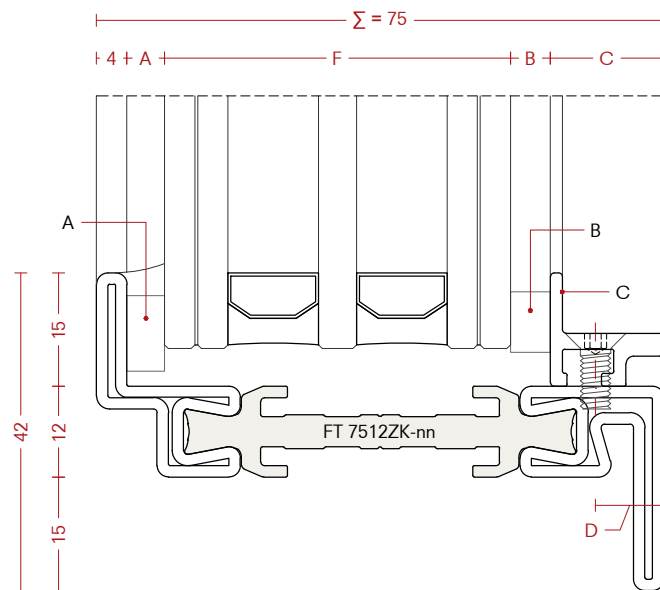
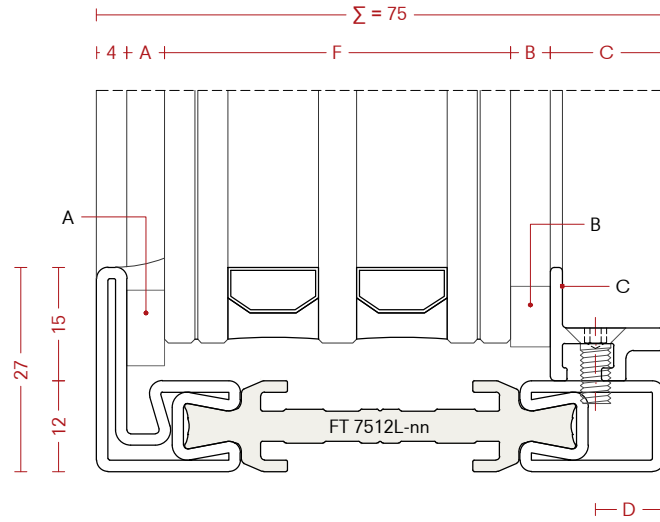

Glazing table



02 - Galvanized steel
05 - Stainless steel AISI 316L 2B
07 - Cor-Ten steel
12 - Bright steel

Tabella vetrazioni

02 - Acciaio zincato
05 - Acciaio inox AISI 316L 2B
07 - Acciaio Cor-Ten
12 - Acciaio decapato

Tabla de acristalamiento

02 - Acero galvanizado
05 - Acero inoxidable AISI 316L 2B
07 - Acero Cor-Ten
12 - Acero bruto

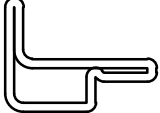
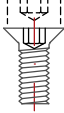
 F mm	 A		 B		 C mm	 D mm
	code	mm	code	mm		
41	G99103-62	5	G99204-61	5.5	20	13.5
42	G99103-62	5	G99203-61	4.5	20	13.5
43	G99102-61	3	G99204-61	5.5	20	13.5
44	G99102-61	3	G99203-61	4.5	20	13.5
45	G99102-61	3	G99202-61	3.5	20	13.5
46	G99102-61	3	G99201-61	2.5	20	13.5

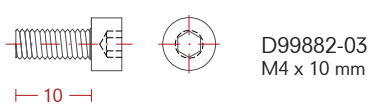
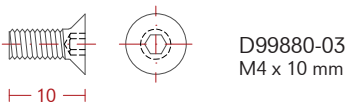
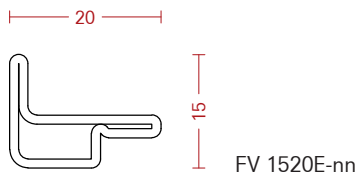

* Glazing table for 75 mm depth profiles.

* Tabella vetrazioni per profili di profondità 75 mm

* Mesa de acristalamiento para perfiles de 75 mm de profundidad.

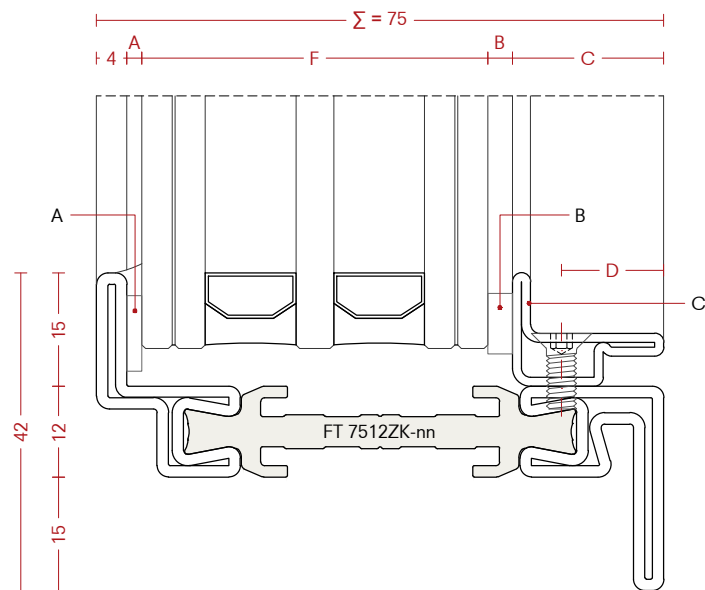
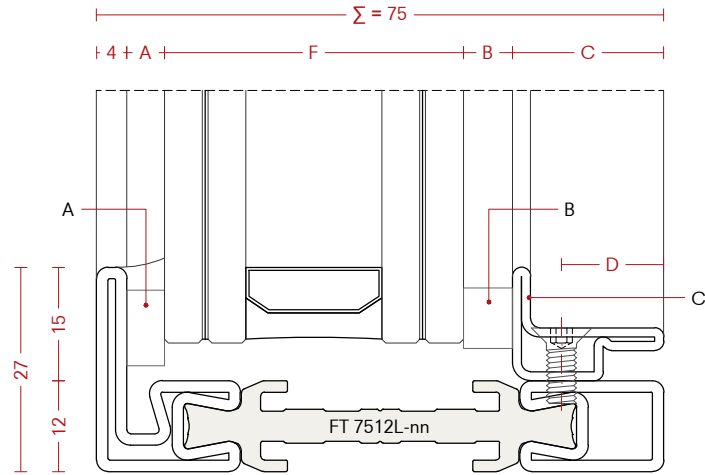

Glazing table



02 - Galvanized steel
05 - Stainless steel AISI 316L 2B
07 - Cor-Ten steel
12 - Bright steel

Tabella vetrazioni

02 - Acciaio zincato
05 - Acciaio inox AISI 316L 2B
07 - Acciaio Cor-Ten
12 - Acciaio decapato

Tabla de acristalamiento

02 - Acero galvanizado
05 - Acero inoxidable AISI 316L 2B
07 - Acero Cor-Ten
12 - Acero bruto

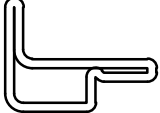
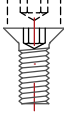
 F mm	 A		 B		 C mm	 D mm
	code	mm	code	mm		
36	G99103-62	5	G99204-61	5.5	25	13.5
37	G99103-62	5	G99203-61	4.5	25	13.5
38	G99102-61	3	G99204-61	5.5	25	13.5
39	G99102-61	3	G99203-61	4.5	25	13.5
40	G99102-61	3	G99202-61	3.5	25	13.5
41	G99102-61	3	G99201-61	2.5	25	13.5

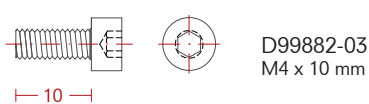
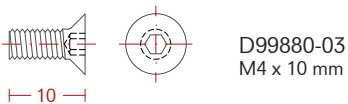
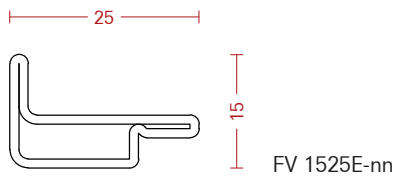

* Glazing table for 75 mm depth profiles.

* Tabella vetrazioni per profili di profondità 75 mm

* Mesa de acristalamiento para perfiles de 75 mm de profundidad.

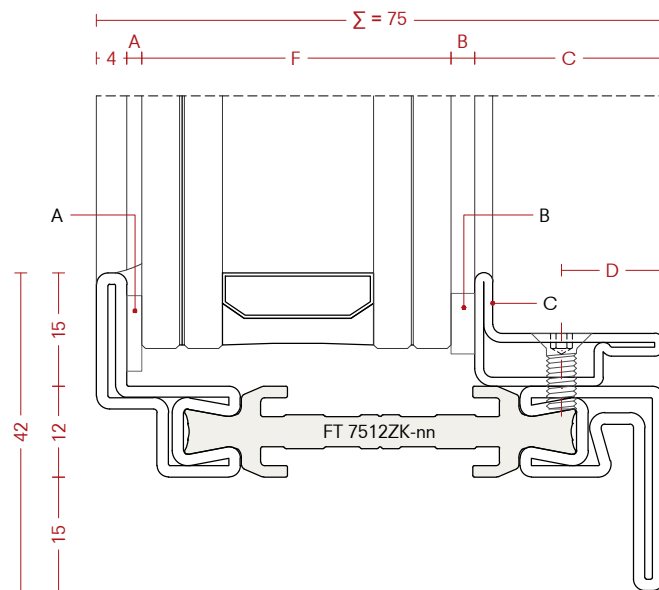
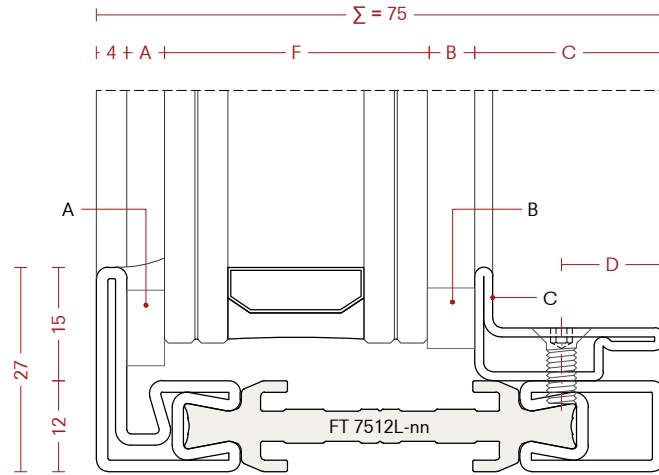

Glazing table

02 - Galvanized steel
05 - Stainless steel AISI 316L 2B
07 - Cor-Ten steel
12 - Bright steel

Tabella vetrazioni

02 - Acciaio zincato
05 - Acciaio inox AISI 316L 2B
07 - Acciaio Cor-Ten
12 - Acciaio decapato

Tabla de acristalamiento

02 - Acero galvanizado
05 - Acero inoxidable AISI 316L 2B
07 - Acero Cor-Ten
12 - Acero bruto

F mm	A		B		C mm	D mm
	code	mm	code	mm		
31	G99103-62	5	G99204-61	5.5	30	13.5
32	G99103-62	5	G99203-61	4.5	30	13.5
33	G99102-61	3	G99204-61	5.5	30	13.5
34	G99102-61	3	G99203-61	4.5	30	13.5
35	G99102-61	3	G99202-61	3.5	30	13.5
36	G99102-61	3	G99201-61	2.5	30	13.5

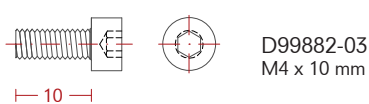
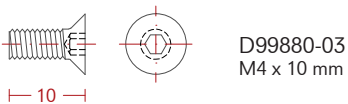
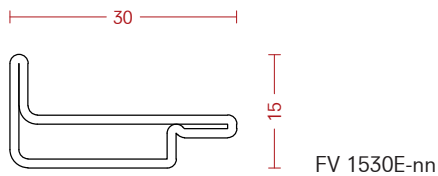

* Glazing table for 75 mm depth profiles.

* Tabella vetrazioni per profili di profondità 75 mm

* Mesa de acristalamiento para perfiles de 75 mm de profundidad.

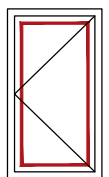
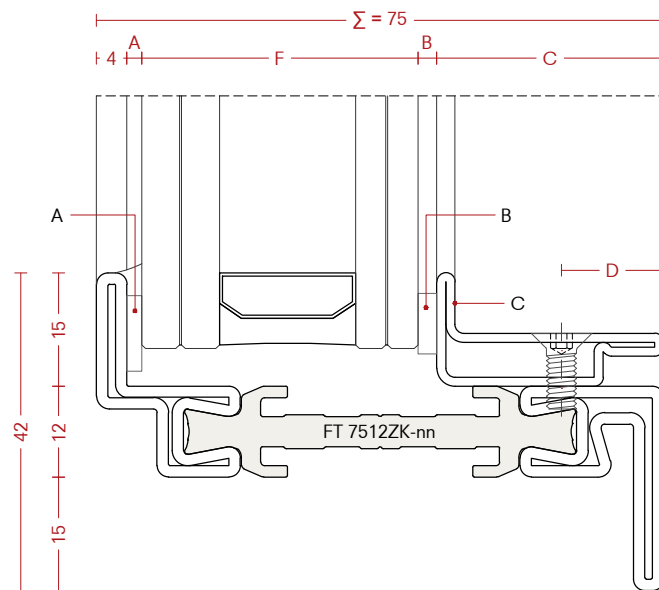
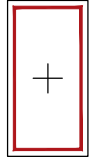
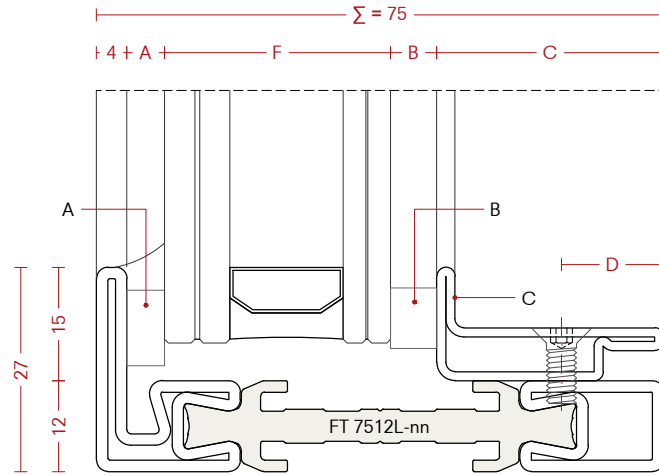

Glazing table



02 - Galvanized steel
05 - Stainless steel AISI 316L 2B
07 - Cor-Ten steel
12 - Bright steel

Tabella vetrazioni

02 - Acciaio zincato
05 - Acciaio inox AISI 316L 2B
07 - Acciaio Cor-Ten
12 - Acciaio decapato

Tabla de acristalamiento

02 - Acero galvanizado
05 - Acero inoxidable AISI 316L 2B
07 - Acero Cor-Ten
12 - Acero bruto

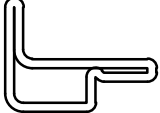
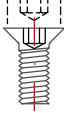
 F	 A		 B		 C	 D
	mm	code	mm	code		
26	G99103-62	5	G99204-61	5.5	35	13.5
27	G99103-62	5	G99203-61	4.5	35	13.5
28	G99102-61	3	G99204-61	5.5	35	13.5
29	G99102-61	3	G99203-61	4.5	35	13.5
30	G99102-61	3	G99202-61	3.5	35	13.5
31	G99102-61	3	G99201-61	2.5	35	13.5

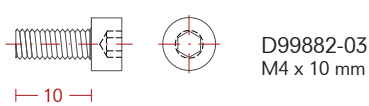
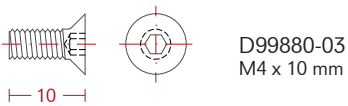
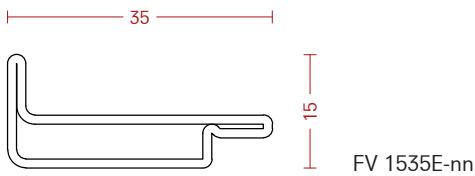

* Glazing table for 75 mm depth profiles.

* Tabella vetrazioni per profili di profondità 75 mm

* Mesa de acristalamiento para perfiles de 75 mm de profundidad.

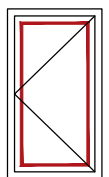
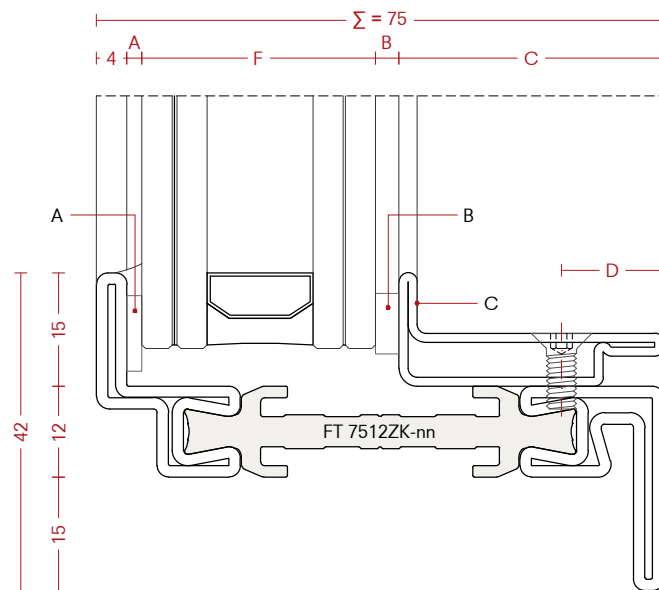
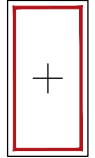
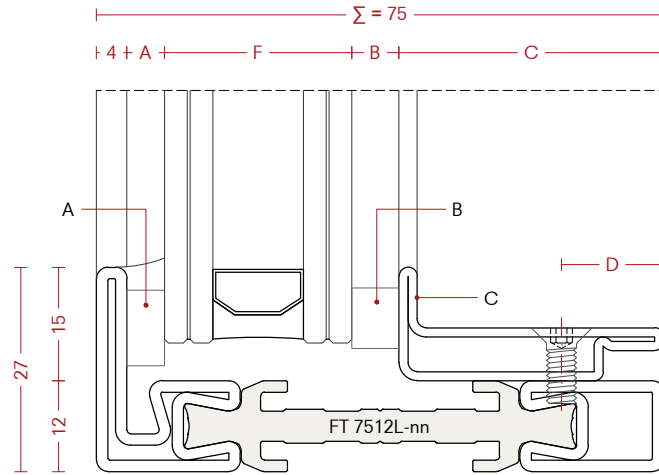

Glazing table





Tabella vetrazioni

Tabla de acristamiento

00 - Aluminium

00 - Alluminio

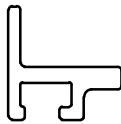
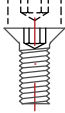
00 - Aluminio

							
	F mm	code	mm	code			
51	G99103-62	5	G99204-61	5.5	15	12	3
52	G99103-62	5	G99203-61	4.5	15	12	3
53	G99102-61	3	G99204-61	5.5	15	12	3
54	G99102-61	3	G99203-61	4.5	15	12	3
55	G99102-61	3	G99202-61	3.5	15	12	3
56	G99102-61	3	G99201-61	2.5	15	12	3

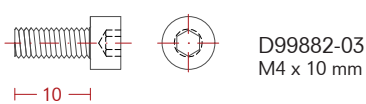
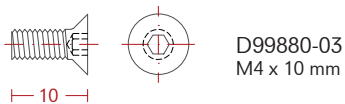
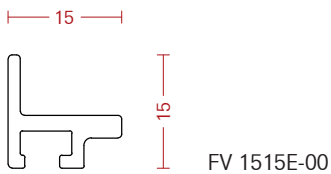

* Glazing table for 83 mm depth profiles.

* Tabella vetrazioni per profili di profondità 83 mm

* Mesa de acristamiento para perfiles de 83 mm de profundidad.

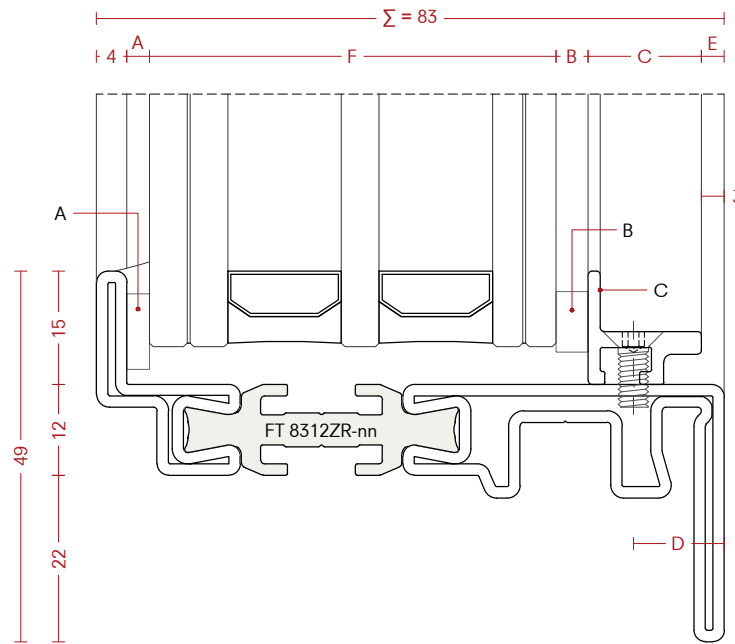
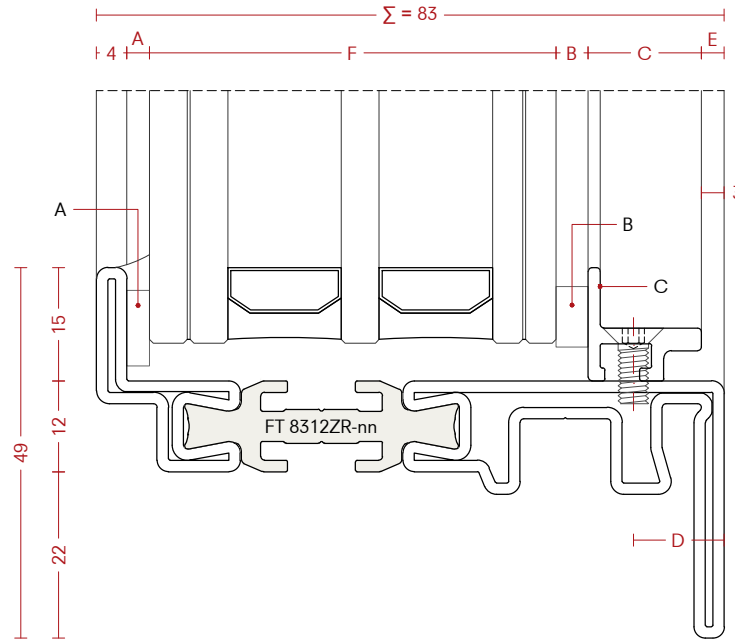

Glazing table



02 - Galvanized steel
05 - Stainless steel AISI 316L 2B
07 - Cor-Ten steel
12 - Bright steel

Tabella vetrazioni

02 - Acciaio zincato
05 - Acciaio inox AISI 316L 2B
07 - Acciaio Cor-Ten
12 - Acciaio decapato

Tabla de acristalamiento

02 - Acero galvanizado
05 - Acero inoxidable AISI 316L 2B
07 - Acero Cor-Ten
12 - Acero bruto

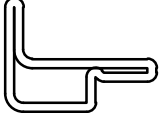
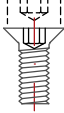
 F mm	 A code mm		 B code mm		 C mm	 D mm
	code	mm	code	mm		
49	G99103-62	5	G99204-61	5.5	20	12
50	G99103-62	5	G99203-61	4.5	20	12
51	G99102-61	3	G99204-61	5.5	20	12
52	G99102-61	3	G99203-61	4.5	20	12
53	G99102-61	3	G99202-61	3.5	20	12
54	G99102-61	3	G99201-61	2.5	20	12

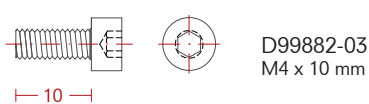
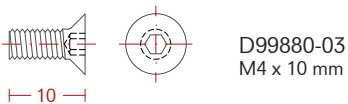
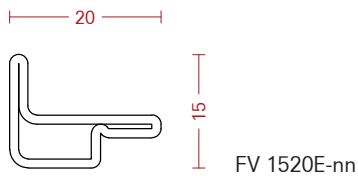

* Glazing table for 83 mm depth profiles.

* Tabella vetrazioni per profili di profondità 83 mm

* Mesa de acristalamiento para perfiles de 83 mm de profundidad.

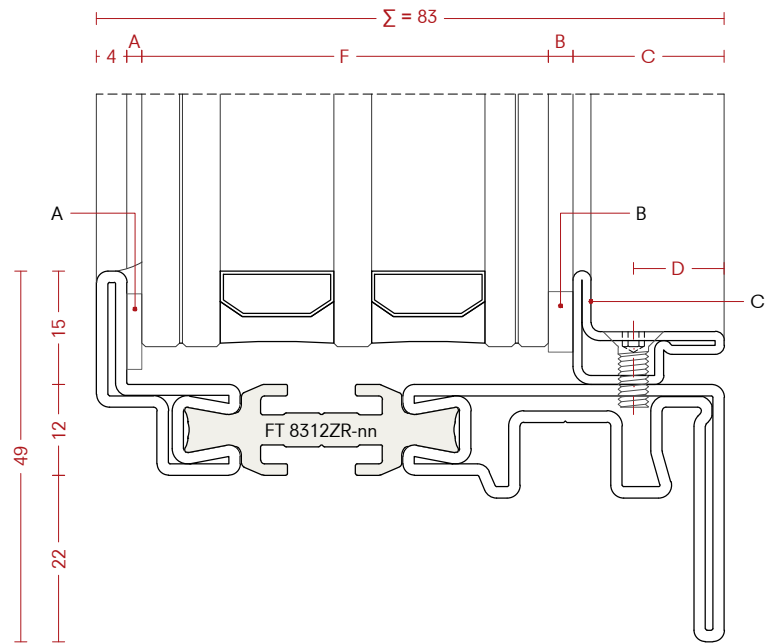
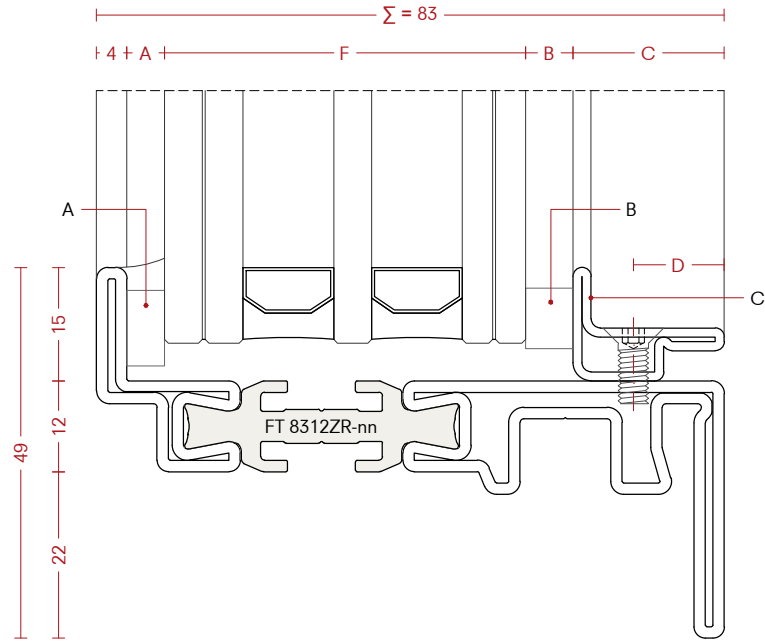

Glazing table



02 - Galvanized steel
05 - Stainless steel AISI 316L 2B
07 - Cor-Ten steel
12 - Bright steel

Tabella vetrazioni

02 - Acciaio zincato
05 - Acciaio inox AISI 316L 2B
07 - Acciaio Cor-Ten
12 - Acciaio decapato

Tabla de acristalamiento

02 - Acero galvanizado
05 - Acero inoxidable AISI 316L 2B
07 - Acero Cor-Ten
12 - Acero bruto

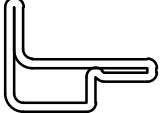
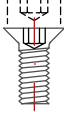
						
F	A		B		C	D
mm	code	mm	code	mm	mm	mm
44	G99103-62	5	G99204-61	5.5	25	13.5
45	G99103-62	5	G99203-61	4.5	25	13.5
46	G99102-61	3	G99204-61	5.5	25	13.5
47	G99102-61	3	G99203-61	4.5	25	13.5
48	G99102-61	3	G99202-61	3.5	25	13.5
49	G99102-61	3	G99201-61	2.5	25	13.5

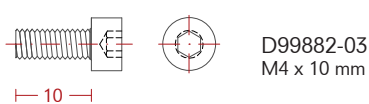
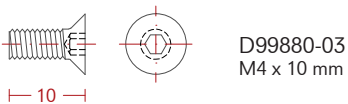
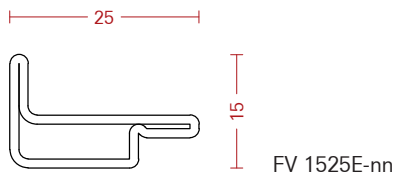

* Glazing table for 83 mm depth profiles.

* Tabella vetrazioni per profili di profondità 83 mm

* Mesa de acristalamiento para perfiles de 83 mm de profundidad.

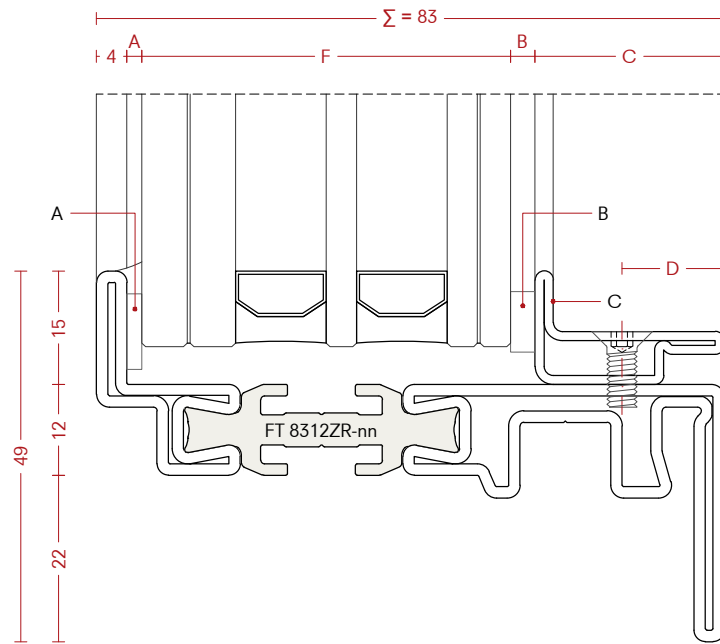
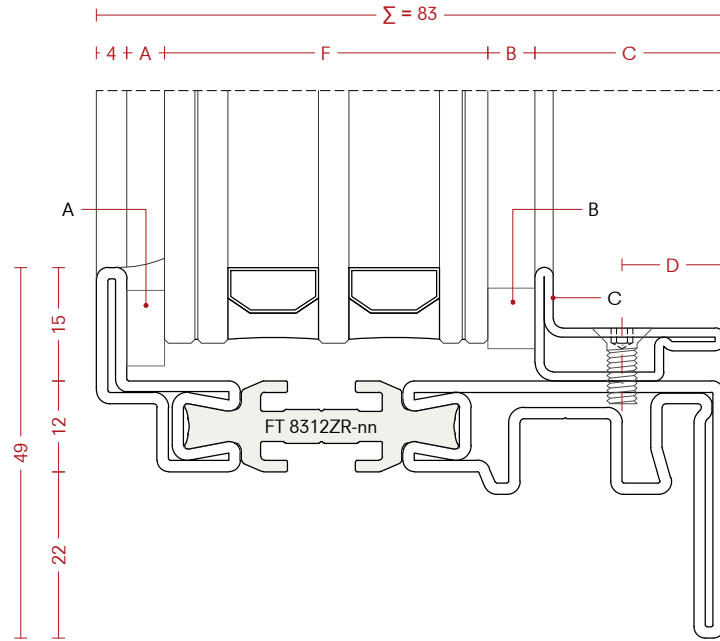

Glazing table



02 - Galvanized steel
05 - Stainless steel AISI 316L 2B
07 - Cor-Ten steel
12 - Bright steel

Tabella vetrazioni

02 - Acciaio zincato
05 - Acciaio inox AISI 316L 2B
07 - Acciaio Cor-Ten
12 - Acciaio decapato

Tabla de acristamiento

02 - Acero galvanizado
05 - Acero inoxidable AISI 316L 2B
07 - Acero Cor-Ten
12 - Acero bruto

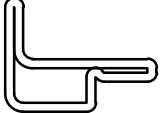
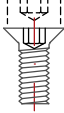
						
F	A		B		C	D
mm	code	mm	code	mm	mm	mm
39	G99103-62	5	G99204-61	5.5	30	13.5
40	G99103-62	5	G99203-61	4.5	30	13.5
41	G99102-61	3	G99204-61	5.5	30	13.5
42	G99102-61	3	G99203-61	4.5	30	13.5
43	G99102-61	3	G99202-61	3.5	30	13.5
44	G99102-61	3	G99201-61	2.5	30	13.5

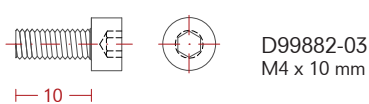
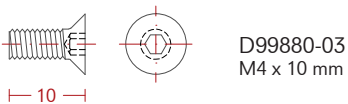
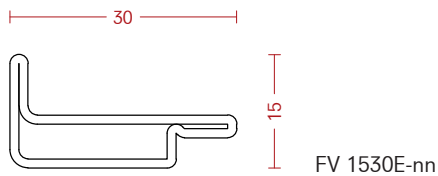

* Glazing table for 83 mm depth profiles.

* Tabella vetrazioni per profili di profondità 83 mm

* Mesa de acristamiento para perfiles de 83 mm de profundidad.

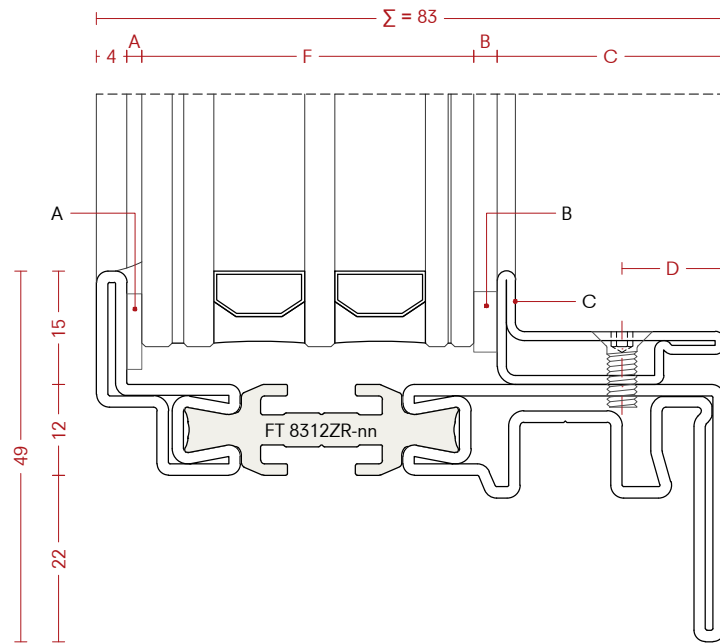
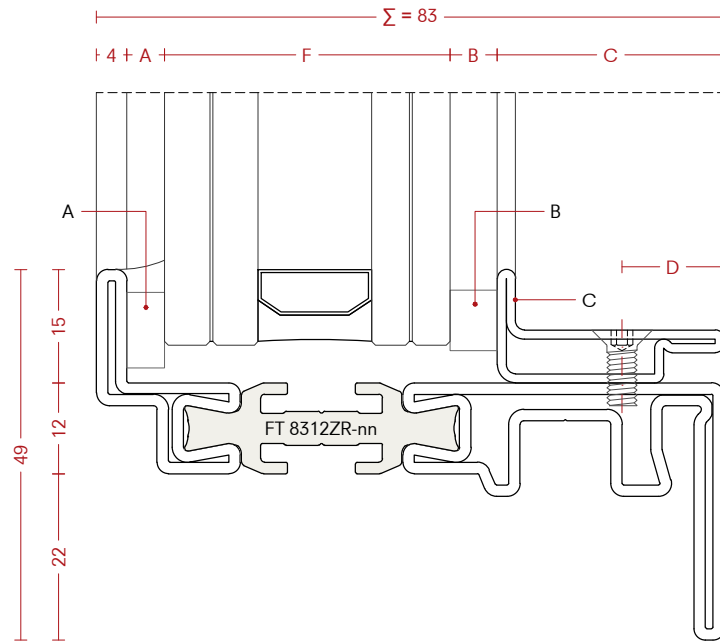

Glazing table



02 - Galvanized steel
05 - Stainless steel AISI 316L 2B
07 - Cor-Ten steel
12 - Bright steel

Tabella vetrazioni

02 - Acciaio zincato
05 - Acciaio inox AISI 316L 2B
07 - Acciaio Cor-Ten
12 - Acciaio decapato

Tabla de acristamiento

02 - Acero galvanizado
05 - Acero inoxidable AISI 316L 2B
07 - Acero Cor-Ten
12 - Acero bruto

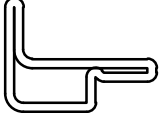
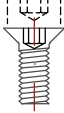
 F mm	 A code mm		 B code mm		 C mm	 D mm
34	G99103-62	5	G99204-61	5.5	35	13.5
35	G99103-62	5	G99203-61	4.5	35	13.5
36	G99102-61	3	G99204-61	5.5	35	13.5
37	G99102-61	3	G99203-61	4.5	35	13.5
38	G99102-61	3	G99202-61	3.5	35	13.5
39	G99102-61	3	G99201-61	2.5	35	13.5

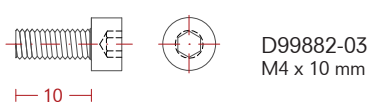
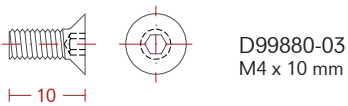
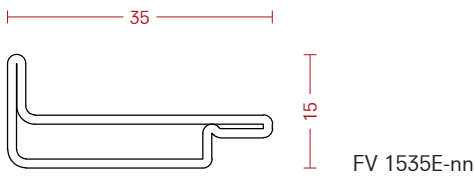

* Glazing table for 83 mm depth profiles.

* Tabella vetrazioni per profili di profondità 83 mm

* Mesa de acristalamiento para perfiles de 83 mm de profundidad.

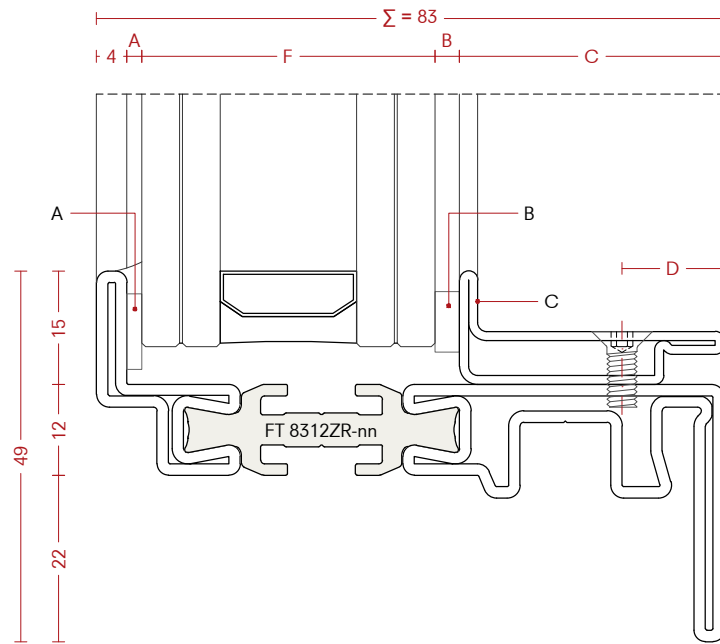
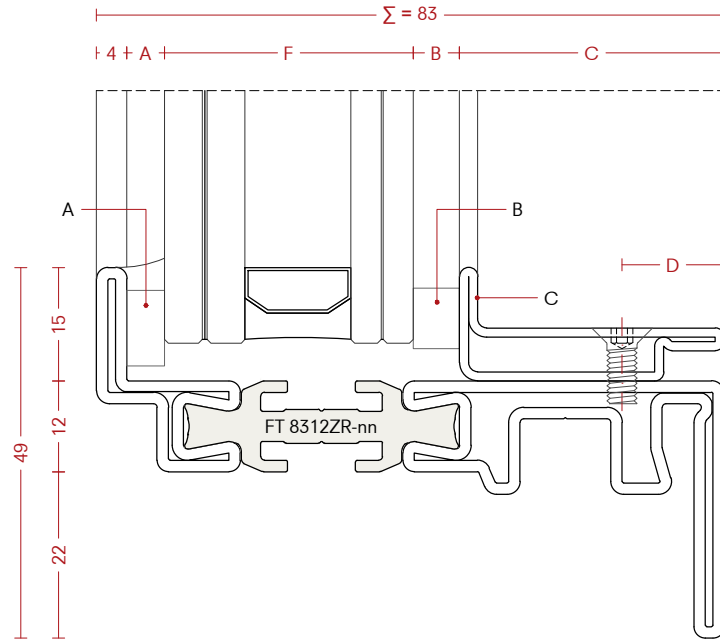

Glazing table



Tabella vetrazioni

Tabla de acristamiento

02 - Galvanized steel

02 - Acciaio zincato

02 - Acero galvanizado

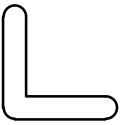
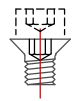
							
F	A		B		C	D	E
mm	code	mm	code	mm	mm	mm	mm
44	G99103-62	5	G99204-61	5.5	15	7.8 / 16.2	1 / 9.5
45	G99103-62	5	G99203-61	4.5	15	7.8 / 16.2	1 / 9.5
46	G99102-61	5	G99202-61	3.5	15	7.8 / 16.2	1 / 9.5
47	G99102-61	3	G99203-61	4.5	15	7.8 / 16.2	1 / 9.5
48	G99102-61	3	G99202-61	3.5	15	7.8 / 16.2	1 / 9.5
49	G99102-61	3	G99201-61	2.5	15	7.8 / 16.2	1 / 9.5

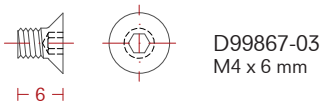
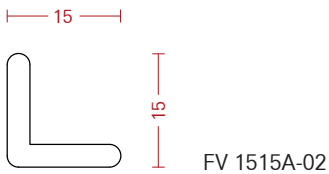

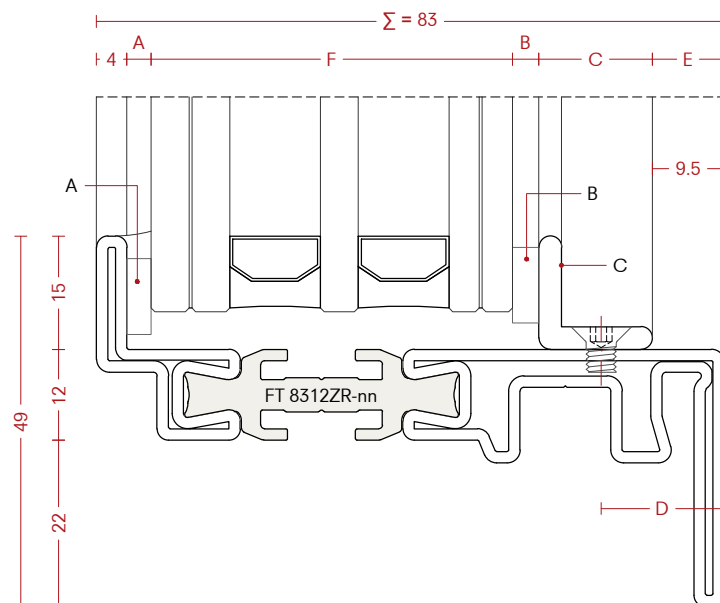
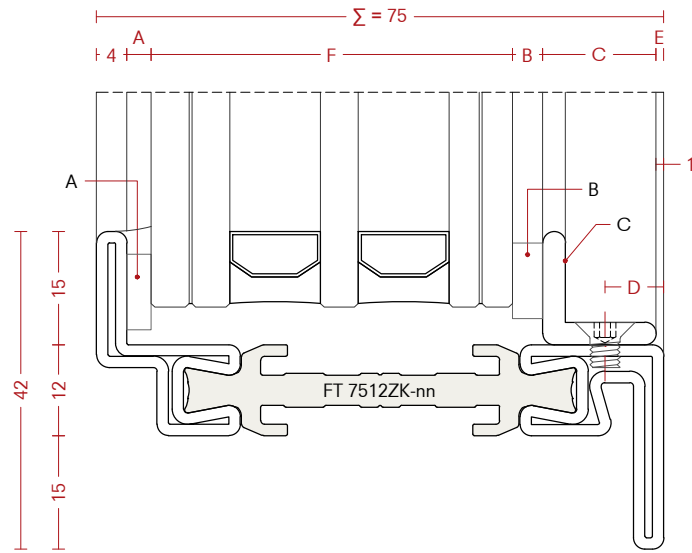
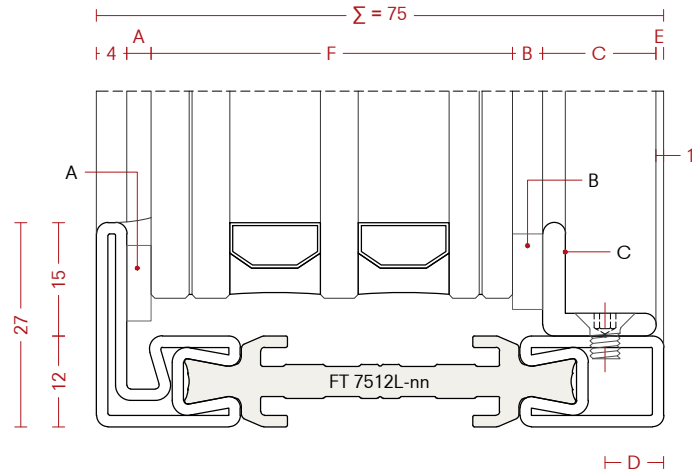

Glazing table





Tabella vetrazioni

Tabla de acristamiento

02 - Galvanized steel

02 - Acciaio zincato

02 - Acero galvanizado

							
F	A		B		C	D	E
mm	code	mm	code	mm	mm	mm	mm
41	G99103-62	5	G99204-61	5.5	18	7.8 / 16.2	1 / 9.5
42	G99103-62	5	G99203-61	4.5	18	7.8 / 16.2	1 / 9.5
43	G99102-61	5	G99202-61	3.5	18	7.8 / 16.2	1 / 9.5
44	G99102-61	3	G99203-61	4.5	18	7.8 / 16.2	1 / 9.5
45	G99102-61	3	G99202-61	3.5	18	7.8 / 16.2	1 / 9.5
46	G99102-61	3	G99201-61	2.5	18	7.8 / 16.2	1 / 9.5

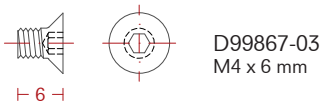
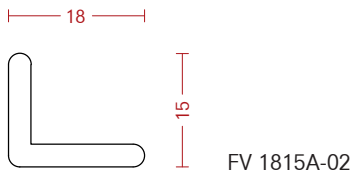

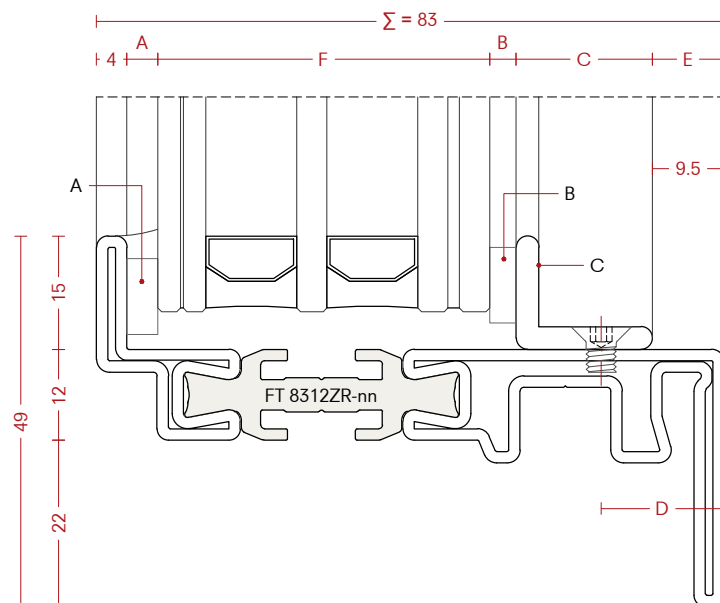
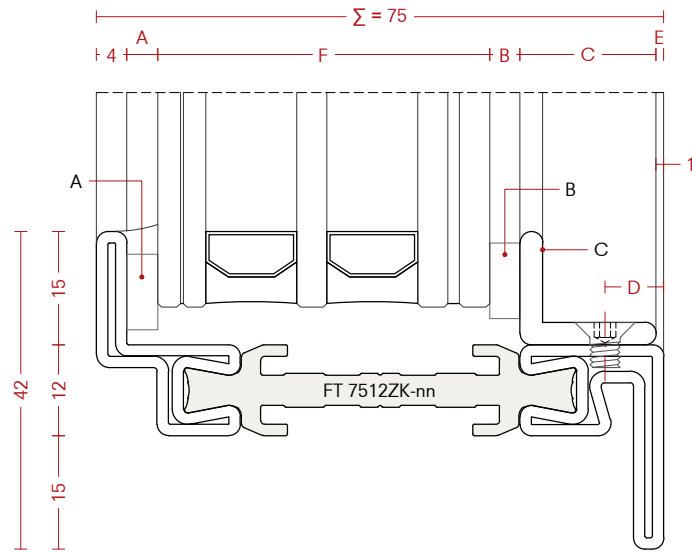
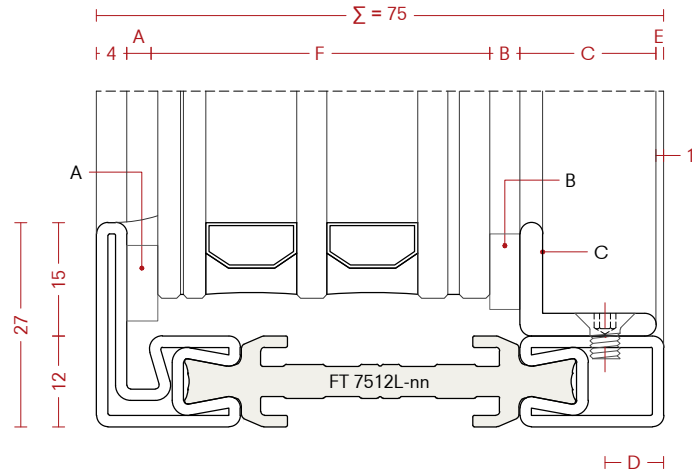

Glazing table





Tabella vetrazioni

Tabla de acristamiento

01 - Hot Rolled Steel

01 - Acciaio laminato a caldo

01 - Acero laminado en caliente

 F mm	 A code mm		 B code mm		 C mm	 D mm	E mm
	code	mm	code	mm			
34	G99103-62	5	G99204-61	5.5	25	13.3 / 21.8	1 / 9.5
35	G99103-62	5	G99203-61	4.5	25	13.3 / 21.8	1 / 9.5
36	G99102-61	5	G99202-61	3.5	25	13.3 / 21.8	1 / 9.5
37	G99102-61	3	G99203-61	4.5	25	13.3 / 21.8	1 / 9.5
38	G99102-61	3	G99202-61	3.5	25	13.3 / 21.8	1 / 9.5
39	G99102-61	3	G99201-61	2.5	25	13.3 / 21.8	1 / 9.5

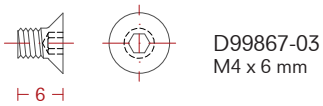
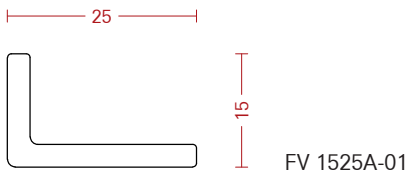

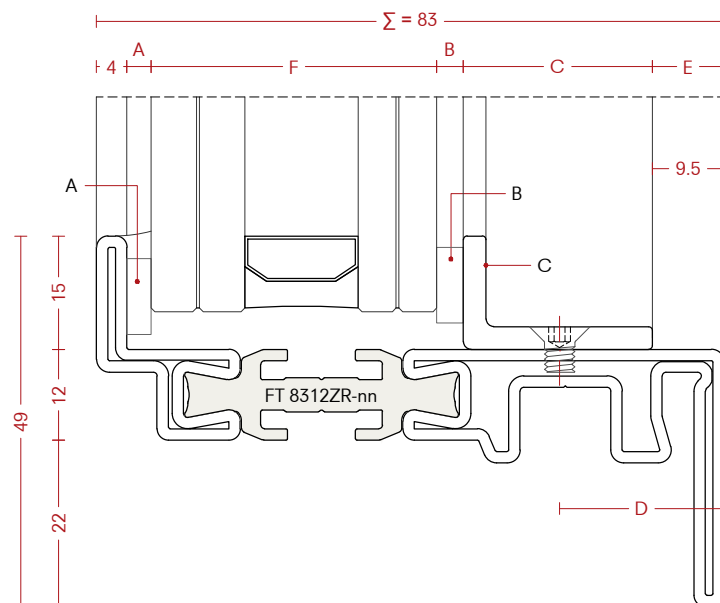
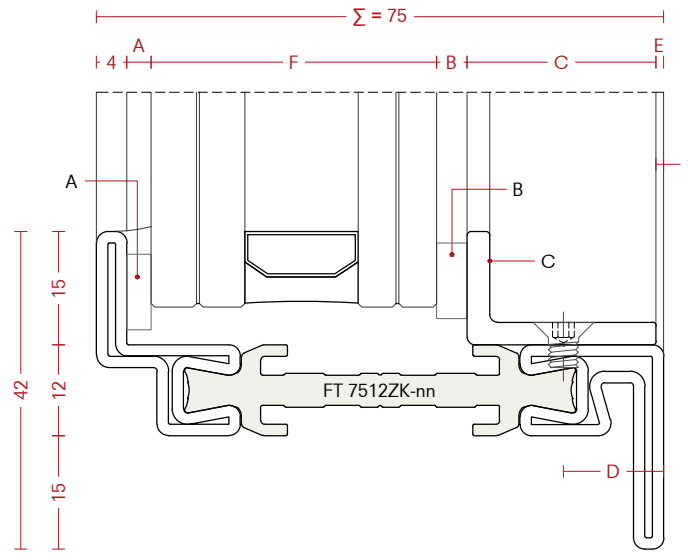
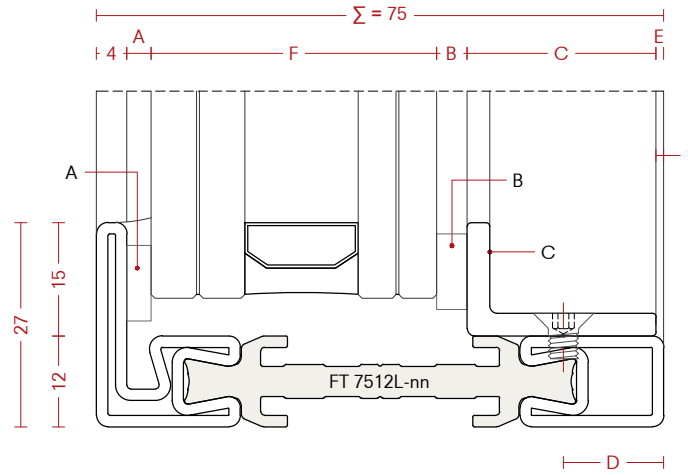

Glazing table

00 - Aluminium
02 - Galvanized steel
06 - Satin stainless steel AISI 316L
07 - Cor-Ten steel
12 - Bright steel

Tabella vetrazioni

00 - Alluminio
02 - Acciaio zincato
06 - Acciaio inox satinato AISI 316L
07 - Acciaio Cor-Ten
12 - Acciaio decapato

Tabla de acristamiento

00 - Aluminio
02 - Acero galvanizado
06 - Acero inoxidable satinado AISI 316L
07 - Acero Cor-Ten
12 - Acero bruto

F mm	A		B		C mm	D E	
	code	mm	code	mm		mm	mm
29	G99103-62	5	G99218-60	6	20	42.5	11
30	G99103-62	5	G99217-60	5	20	42.5	11
31	G99103-62	5	G99216-60	4	20	42.5	11
32	G99102-61	3	G99217-60	5	20	42.5	11
33	G99102-61	3	G99216-60	4	20	42.5	11
34	G99102-61	3	G99215-60	3	20	42.5	11
34	G99103-62	5	G99218-60	6	20	37.5	6
35	G99103-62	5	G99217-60	5	20	37.5	6
36	G99103-62	5	G99216-60	4	20	37.5	6
37	G99102-61	3	G99217-60	5	20	37.5	6
38	G99102-61	3	G99216-60	4	20	37.5	6
39	G99102-61	3	G99215-60	3	20	37.5	6
39	G99103-62	5	G99218-60	6	20	32.5	1
40	G99103-62	5	G99217-60	5	20	32.5	1
41	G99103-62	5	G99216-60	4	20	32.5	1
42	G99102-61	3	G99217-60	5	20	32.5	1
43	G99102-61	3	G99216-60	4	20	32.5	1
44	G99102-61	3	G99215-60	3	20	32.5	1

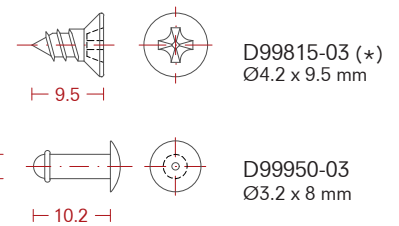
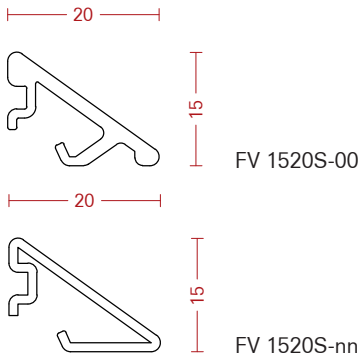

* Glazing table for 75 mm depth profiles.

* Tabella vetrazioni per profili di profondità 75 mm

* Mesa de acristamiento para perfiles de 75 mm de profundidad.

(*) Only in case of multipoint lock installation use externally installed screw D99815-03.

(*) Solamente nel caso di installazione chiusura multipoint usare vite D99815-03 installata dall'esterno.

(*) Solo en caso de instalación de bloqueo multipunto, utilice el tornillo D99815-03 instalado externamente.

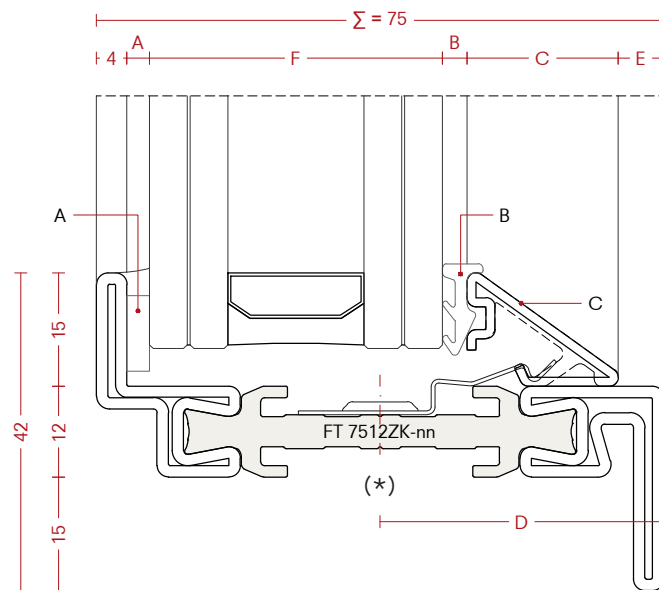
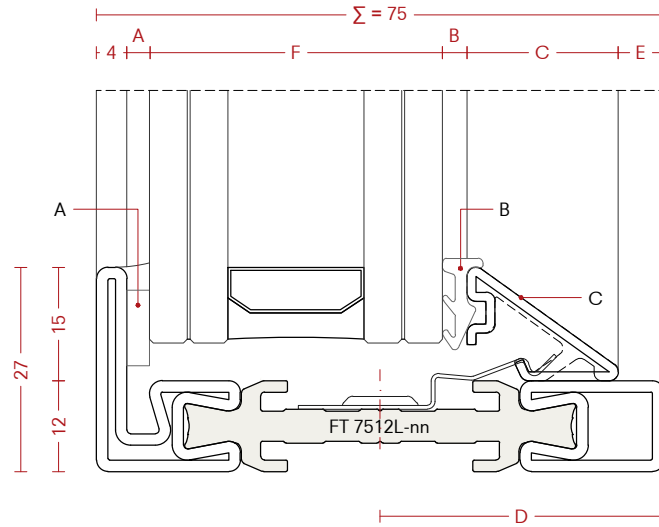

(*) Only in case of multipoint lock installation use externally installed screw D99815-03.

(*) Solamente nel caso di installazione chiusura multipoint usare vite D99815-03 installata dall'esterno.

(*) Solo en caso de instalación de bloqueo multipunto, utilice el tornillo D99815-03 instalado externamente.

Glazing table

- 00 - Aluminium
- 02 - Galvanized steel
- 06 - Satin stainless steel AISI 316L
- 07 - Cor-Ten steel
- 12 - Bright steel

Tabella vetrazioni

- 00 - Alluminio
- 02 - Acciaio zincato
- 06 - Acciaio inox satinato AISI 316L
- 07 - Acciaio Cor-Ten
- 12 - Acciaio decapato

Tabla de acristamiento

- 00 - Aluminio
- 02 - Acero galvanizado
- 06 - Acero inoxidable satinado AISI 316L
- 07 - Acero Cor-Ten
- 12 - Acero bruto

F mm	A		B		C mm	D		E mm
	code	mm	code	mm		mm	mm	
34	G99103-62	5	G99218-60	6	20	39	14	
35	G99103-62	5	G99217-60	5	20	39	14	
36	G99103-62	5	G99216-60	4	20	39	14	
37	G99102-61	3	G99217-60	5	20	39	14	
38	G99102-61	3	G99216-60	4	20	39	14	
39	G99102-61	3	G99215-60	3	20	39	14	
39	G99103-62	5	G99218-60	6	20	39	9	
40	G99103-62	5	G99217-60	5	20	39	9	
41	G99103-62	5	G99216-60	4	20	39	9	
42	G99102-61	3	G99217-60	5	20	39	9	
43	G99102-61	3	G99216-60	4	20	39	9	
44	G99102-61	3	G99215-60	3	20	39	9	

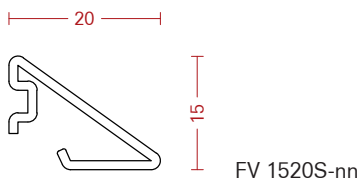
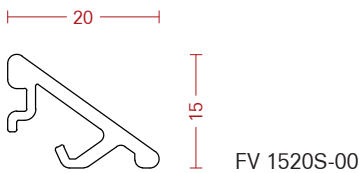

* Glazing table for 83 mm depth profiles.

* Tabella vetrazioni per profili di profondità 83 mm

* Mesa de acristamiento para perfiles de 83 mm de profundidad.

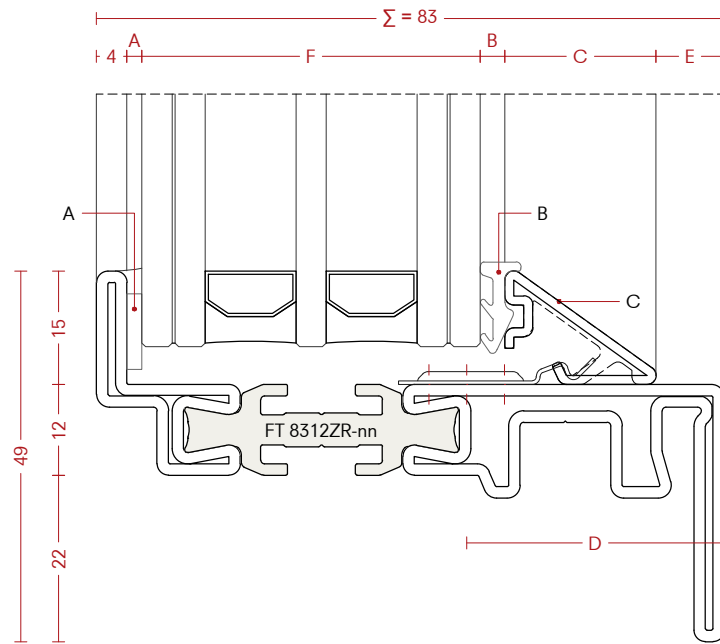
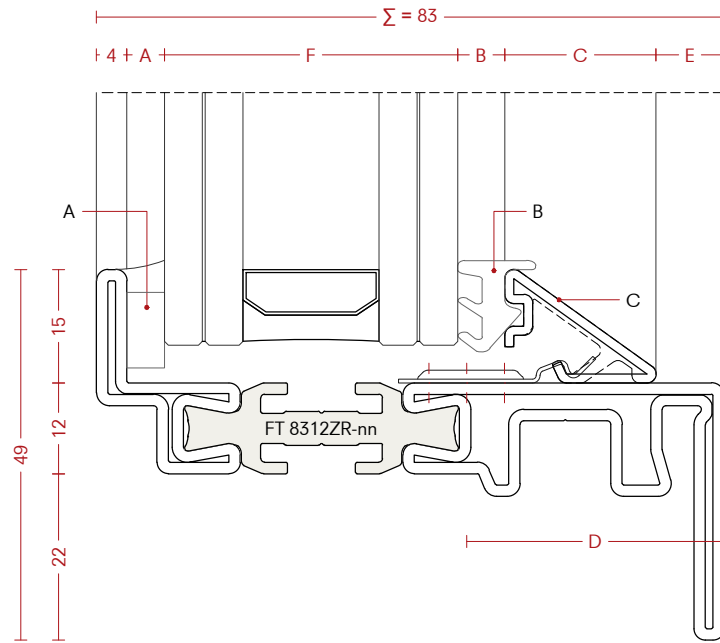

Glazing table

- 00 - Aluminium
- 02 - Galvanized steel
- 06 - Satin stainless steel AISI 316L
- 07 - Cor-Ten steel
- 12 - Bright steel

Tabella vetrazioni

- 00 - Alluminio
- 02 - Acciaio zincato
- 06 - Acciaio inox satinato AISI 316L
- 07 - Acciaio Cor-Ten
- 12 - Acciaio decapato

Tabla de acristamiento

- 00 - Aluminio
- 02 - Acero galvanizado
- 06 - Acero inoxidable satinado AISI 316L
- 07 - Acero Cor-Ten
- 12 - Acero bruto

F mm	A		B		C mm	D		E mm
	code	mm	code	mm		mm	mm	
24	G99103-62	5	G99218-60	6	30	42.5	6	
25	G99103-62	5	G99217-60	5	30	42.5	6	
26	G99103-62	5	G99216-60	4	30	42.5	6	
27	G99102-61	3	G99217-60	5	30	42.5	6	
28	G99102-61	3	G99216-60	4	30	42.5	6	
29	G99102-61	3	G99215-60	3	30	42.5	6	
29	G99103-62	5	G99218-60	6	30	37.5	1	
30	G99103-62	5	G99217-60	5	30	37.5	1	
31	G99103-62	5	G99216-60	4	30	37.5	1	
32	G99102-61	3	G99217-60	5	30	37.5	1	
33	G99102-61	3	G99216-60	4	30	37.5	1	
34	G99102-61	3	G99215-60	3	30	37.5	1	

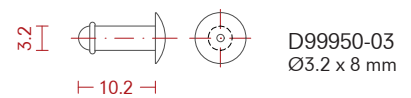
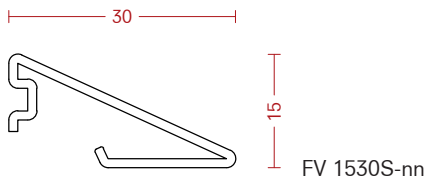
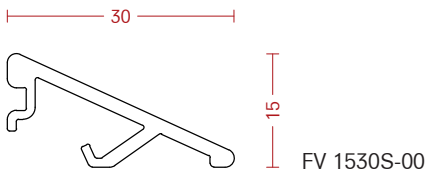

* Glazing table for 75 mm depth profiles.

* Tabella vetrazioni per profili di profondità 75 mm

* Mesa de acristamiento para perfiles de 75 mm de profundidad.

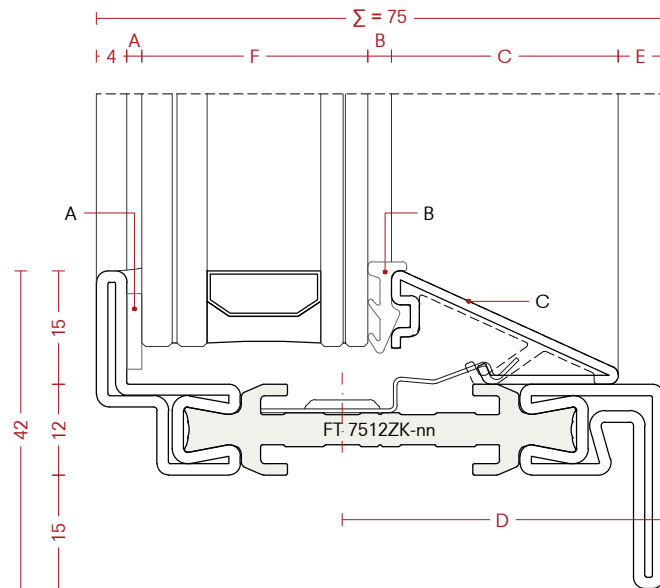
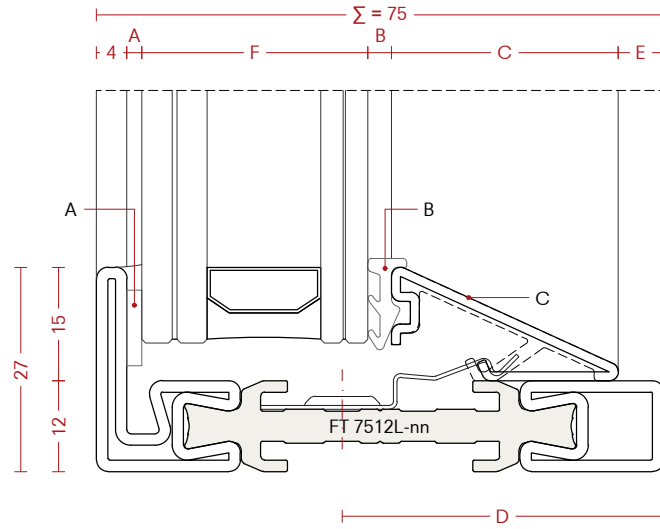

Glazing table

- 00 - Aluminium
- 02 - Galvanized steel
- 06 - Satin stainless steel AISI 316L
- 07 - Cor-Ten steel
- 12 - Bright steel

Tabella vetrazioni

- 00 - Alluminio
- 02 - Acciaio zincato
- 06 - Acciaio inox satinato AISI 316L
- 07 - Acciaio Cor-Ten
- 12 - Acciaio decapato

Tabla de acristamiento

- 00 - Aluminio
- 02 - Acero galvanizado
- 06 - Acero inoxidable satinado AISI 316L
- 07 - Acero Cor-Ten
- 12 - Acero bruto

F mm	A		B		C mm	D mm	E mm
	code	mm	code	mm			
29	G99103-62	5	G99218-60	6	30	39	9
30	G99103-62	5	G99217-60	5	30	39	9
31	G99103-62	5	G99216-60	4	30	39	9
32	G99102-61	3	G99217-60	5	30	39	9
33	G99102-61	3	G99216-60	4	30	39	9
34	G99102-61	3	G99215-60	3	30	39	9
34	G99103-62	5	G99218-60	6	30	39	4
35	G99103-62	5	G99217-60	5	30	39	4
36	G99103-62	5	G99216-60	4	30	39	4
37	G99102-61	3	G99217-60	5	30	39	4
38	G99102-61	3	G99216-60	4	30	39	4
39	G99102-61	3	G99215-60	3	30	39	4

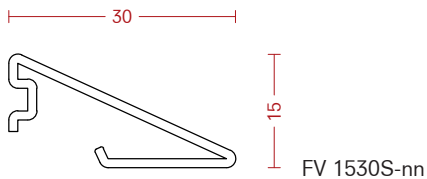
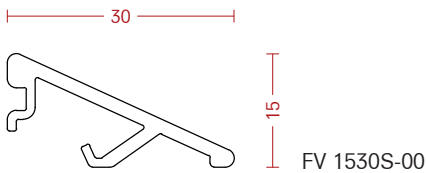

* Glazing table for 83 mm depth profiles.

* Tabella vetrazioni per profili di profondità 83 mm

* Mesa de acristamiento para perfiles de 83 mm de profundidad.

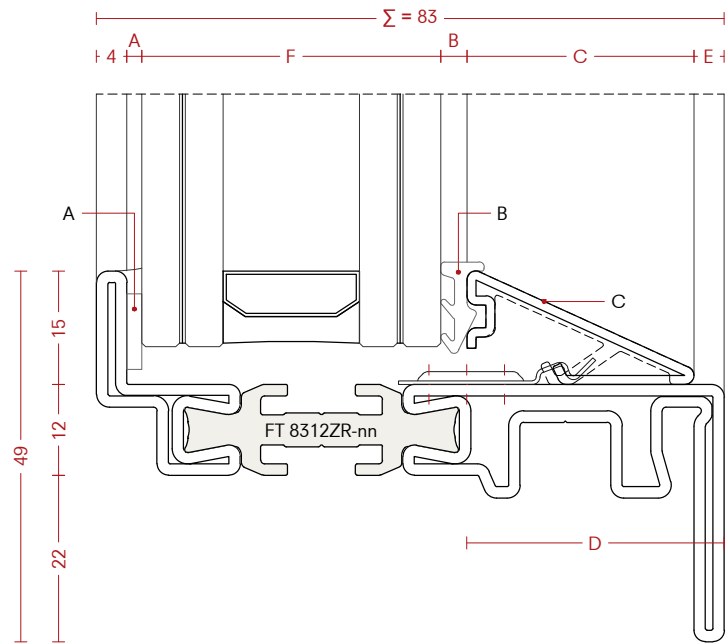
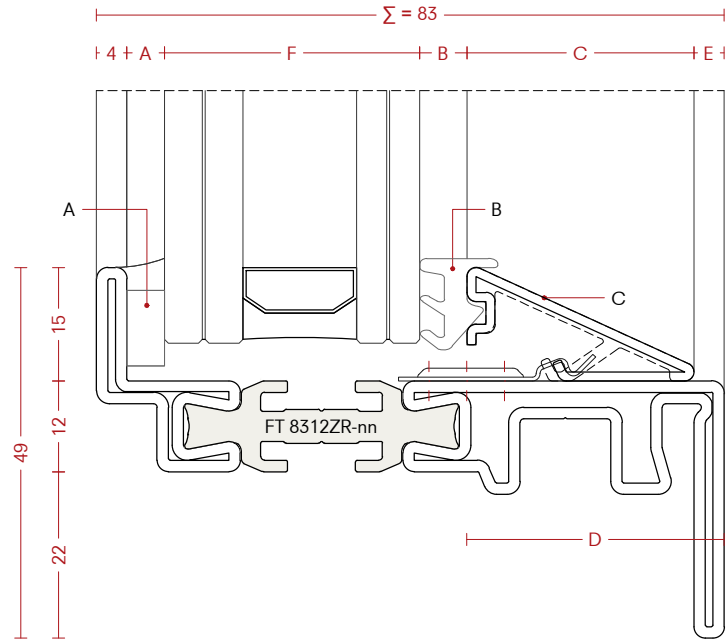

Glazing table





Tabella vetrazioni

Tabla de acristamiento

00 - Aluminium

00 - Alluminio

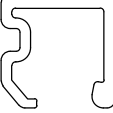
00 - Aluminio

 F mm	 A code mm		 B code mm		 C mm	 D mm	 E mm
	code	mm	code	mm			
44	G99108-60 / G99103-62	5	G99218-60	6	15	8.5 / 16.5	1 / 9
45	G99103-62	5	G99217-60	5	15	8.5 / 16.5	1 / 9
46	G99107-60 / G99102-61	3	G99218-60	6	15	8.5 / 16.5	1 / 9
47	G99107-60 / G99102-61	3	G99217-60	5	15	8.5 / 16.5	1 / 9
48	G99107-60 / G99102-61	3	G99216-60	4	15	8.5 / 16.5	1 / 9
49	G99107-60 / G99102-61	3	G99215-60	3	15	8.5 / 16.5	1 / 9

15

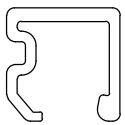

FV 1515R-00

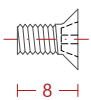

D99980-02
M4 x 8 mm

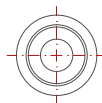

F99063-03

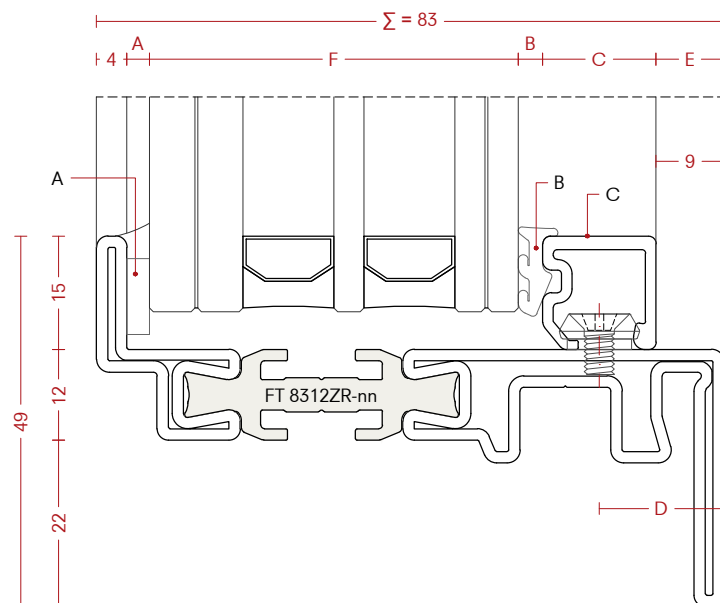
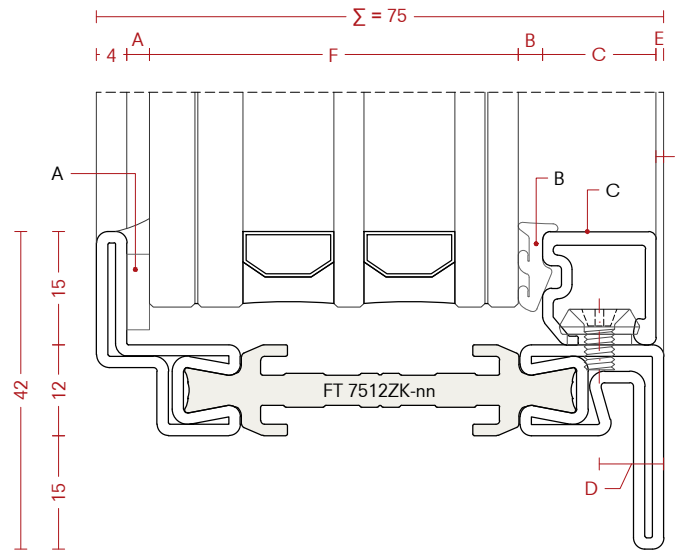
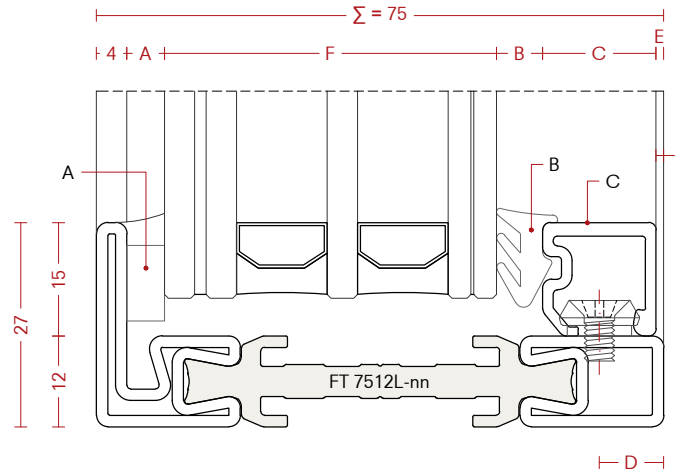

Glazing table



00 - Aluminium
02 - Galvanized steel
05 - Stainless steel AISI 316L 2B
07 - Cor-Ten steel
12 - Bright steel

Tabella vetrazioni

00 - Alluminio
02 - Acciaio zincato
05 - Acciaio inox AISI 316L 2B
07 - Acciaio Cor-Ten
12 - Acciaio decapato

Tabla de acristamiento

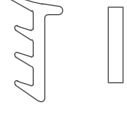
00 - Aluminio
02 - Acero galvanizado
05 - Acero inoxidable AISI 316L 2B
07 - Acero Cor-Ten
12 - Acero bruto

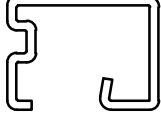
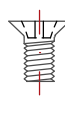
 F mm	 A code		 B code	mm	 C mm	 D mm	E mm
	mm	code					
39	5	G99108-60 / G99103-62	G99218-60	6	20	13.5 / 21.5	1 / 9
40	5	G99103-62	G99217-60	5	20	13.5 / 21.5	1 / 9
41	3	G99107-60 / G99102-61	G99218-60	6	20	13.5 / 21.5	1 / 9
42	3	G99107-60 / G99102-61	G99217-60	5	20	13.5 / 21.5	1 / 9
43	3	G99107-60 / G99102-61	G99216-60	4	20	13.5 / 21.5	1 / 9
44	3	G99107-60 / G99102-61	G99215-60	3	20	13.5 / 21.5	1 / 9

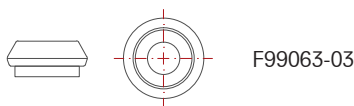
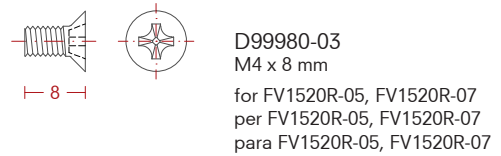
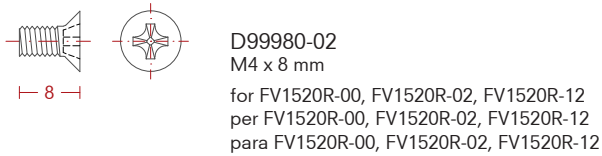
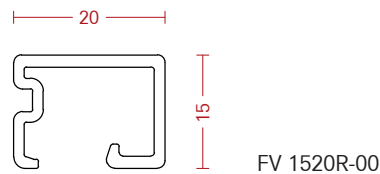
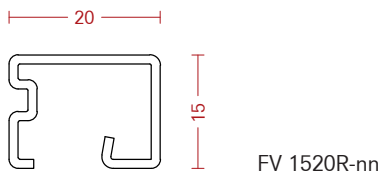

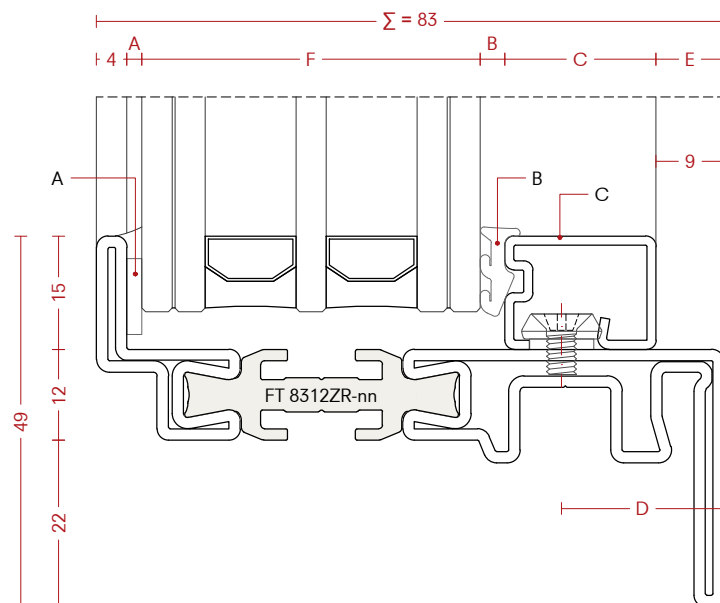
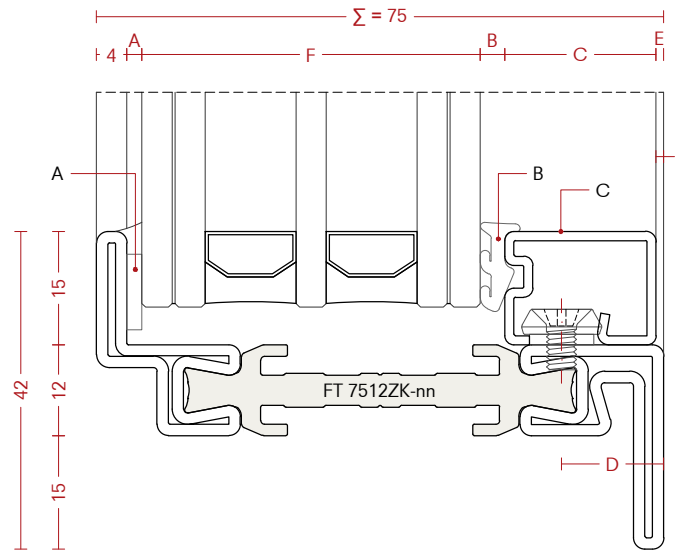
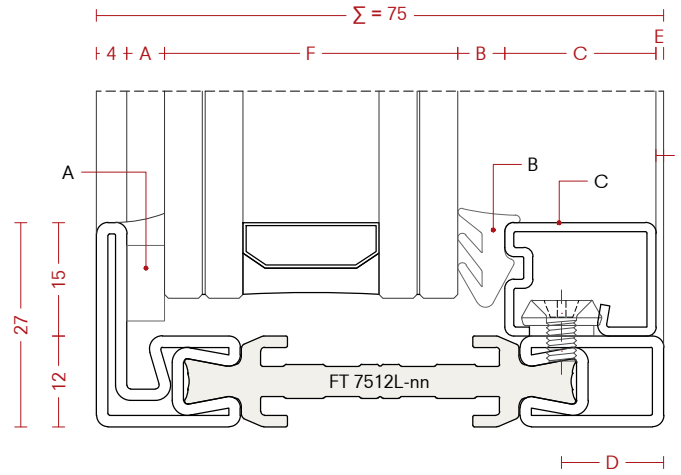

Glazing table





- 00 - Aluminium
- 02 - Galvanized steel
- 05 - Stainless steel AISI 316L 2B
- 07 - Cor-Ten steel
- 12 - Bright steel

Tabella vetrazioni

- 00 - Alluminio
- 02 - Acciaio zincato
- 05 - Acciaio inox AISI 316L 2B
- 07 - Acciaio Cor-Ten
- 12 - Acciaio decapato

Tabla de acristamiento

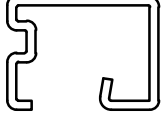
- 00 - Aluminio
- 02 - Acero galvanizado
- 05 - Acero inoxidable AISI 316L 2B
- 07 - Acero Cor-Ten
- 12 - Acero bruto

 F mm	 A code		 B code	mm	 C mm	 D mm	E mm
	mm	code					
34	G99108-60 / G99103-62	5	G99218-60	6	25	13.5 / 21.5	1 / 9
35	G99103-62	5	G99217-60	5	25	13.5 / 21.5	1 / 9
36	G99107-60 / G99102-61	3	G99218-60	6	25	13.5 / 21.5	1 / 9
37	G99107-60 / G99102-61	3	G99217-60	5	25	13.5 / 21.5	1 / 9
38	G99107-60 / G99102-61	3	G99216-60	4	25	13.5 / 21.5	1 / 9
39	G99107-60 / G99102-61	3	G99215-60	3	25	13.5 / 21.5	1 / 9

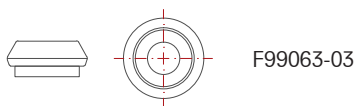
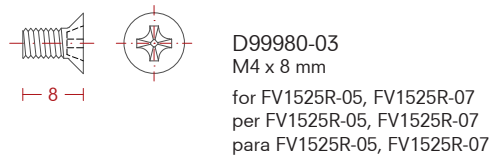
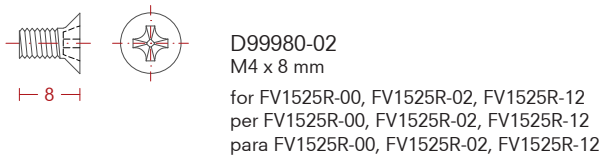
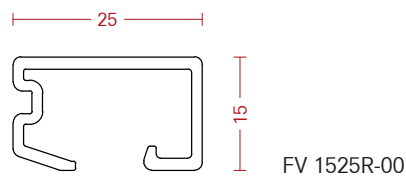
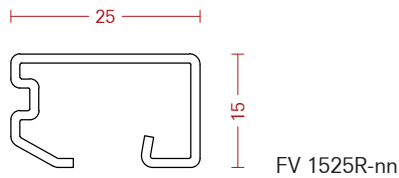

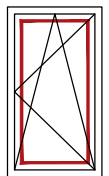
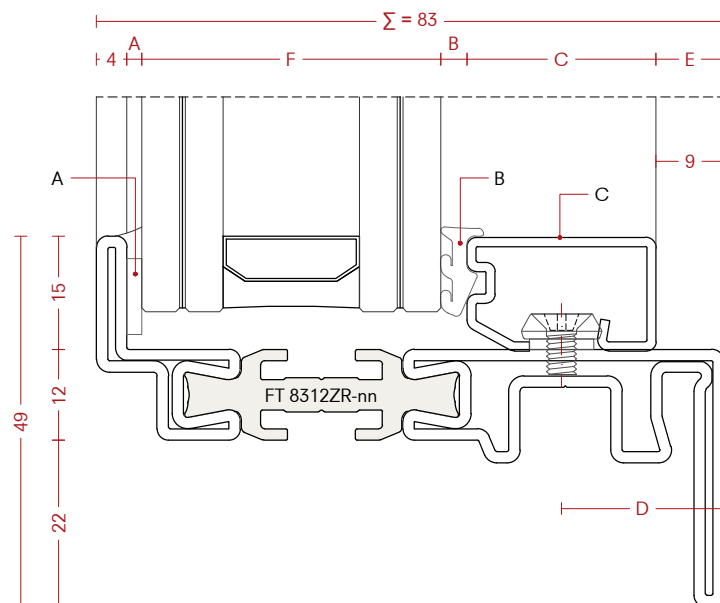
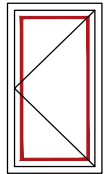
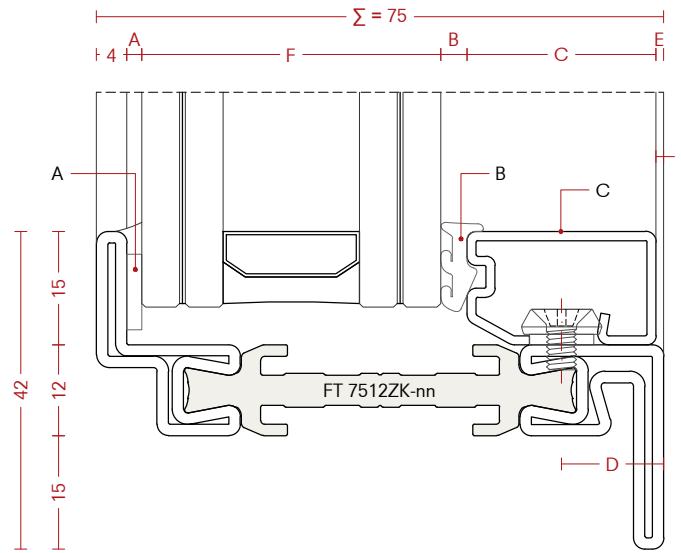
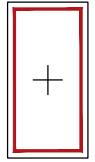
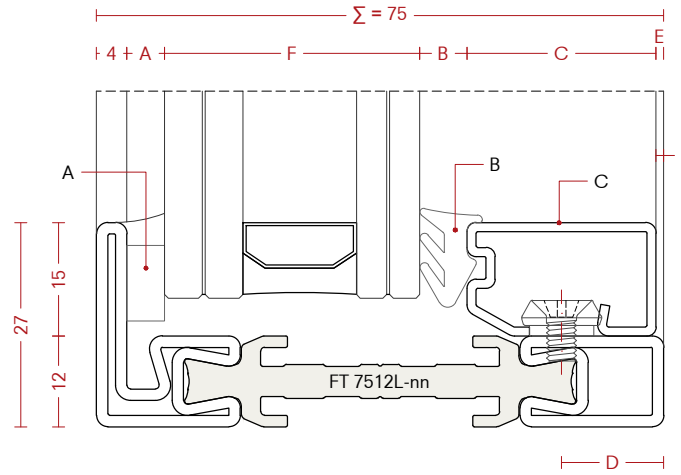

Glazing table





00 - Aluminium
02 - Galvanized steel
05 - Stainless steel AISI 316L 2B
07 - Cor-Ten steel
12 - Bright steel

Tabella vetrazioni

00 - Alluminio
02 - Acciaio zincato
05 - Acciaio inox AISI 316L 2B
07 - Acciaio Cor-Ten
12 - Acciaio decapato

Tabla de acristamiento

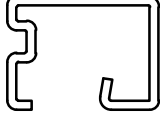
00 - Aluminio
02 - Acero galvanizado
05 - Acero inoxidable AISI 316L 2B
07 - Acero Cor-Ten
12 - Acero bruto

 F mm	 A code		 B code	mm	 C mm	 D mm	E mm
	mm	code					
29	G99108-60 / G99103-62	5	G99218-60	6	30	13.5 / 21.5	1 / 9
30	G99103-62	5	G99217-60	5	30	13.5 / 21.5	1 / 9
31	G99107-60 / G99102-61	3	G99218-60	6	30	13.5 / 21.5	1 / 9
32	G99107-60 / G99102-61	3	G99217-60	5	30	13.5 / 21.5	1 / 9
33	G99107-60 / G99102-61	3	G99216-60	4	30	13.5 / 21.5	1 / 9
34	G99107-60 / G99102-61	3	G99215-60	3	30	13.5 / 21.5	1 / 9

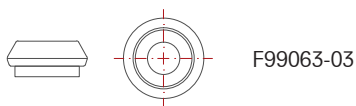
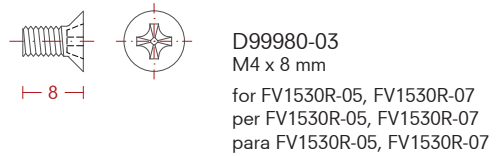
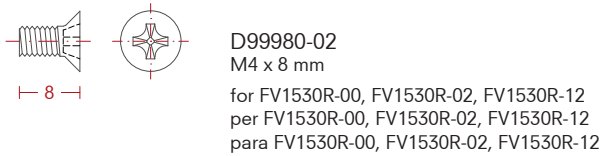
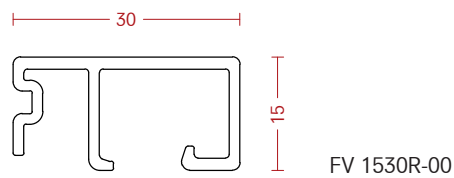
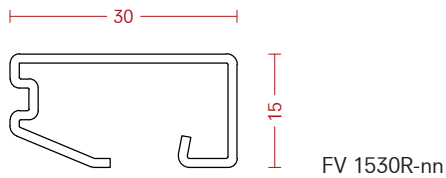

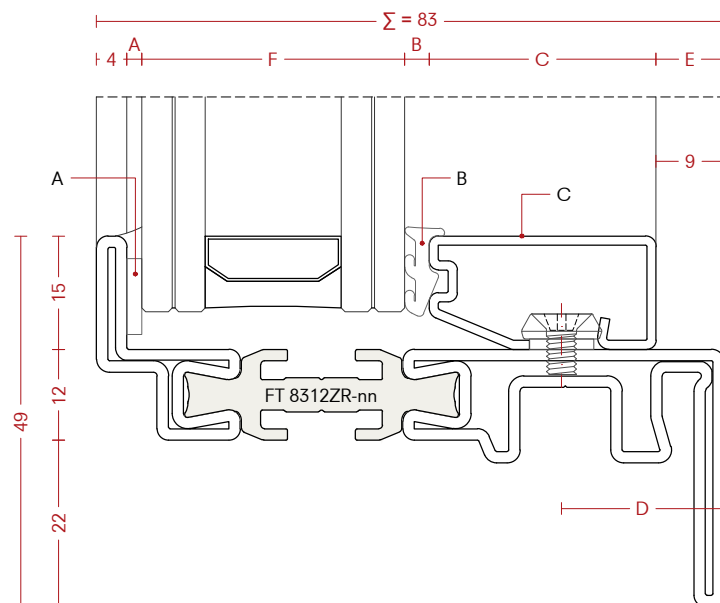
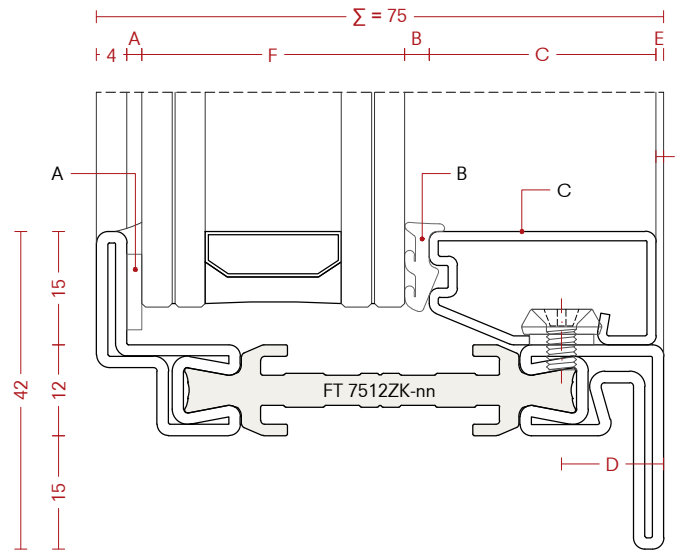
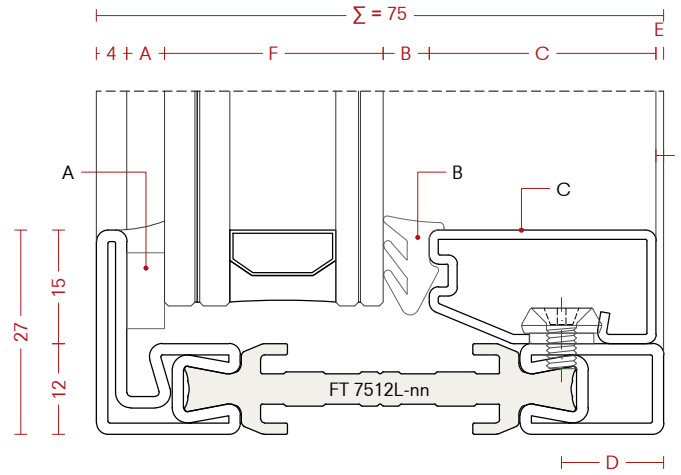

Glazing table

Tabella vetrazioni

Tabla de acristamiento

00 - Aluminium

00 - Alluminio

00 - Aluminio

F mm	A		B		C mm	D mm	E mm
	code	mm	code	mm			
24	G99108-60 / G99103-62	5	G99218-60	6	35	13.5 / 21.5	1 / 9
25	G99103-62	5	G99217-60	5	35	13.5 / 21.5	1 / 9
26	G99107-60 / G99102-61	3	G99218-60	6	35	13.5 / 21.5	1 / 9
27	G99107-60 / G99102-61	3	G99217-60	5	35	13.5 / 21.5	1 / 9
28	G99107-60 / G99102-61	3	G99216-60	4	35	13.5 / 21.5	1 / 9
29	G99107-60 / G99102-61	3	G99215-60	3	35	13.5 / 21.5	1 / 9

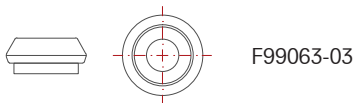
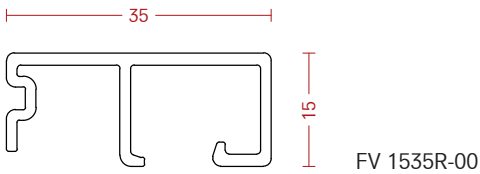

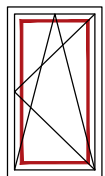
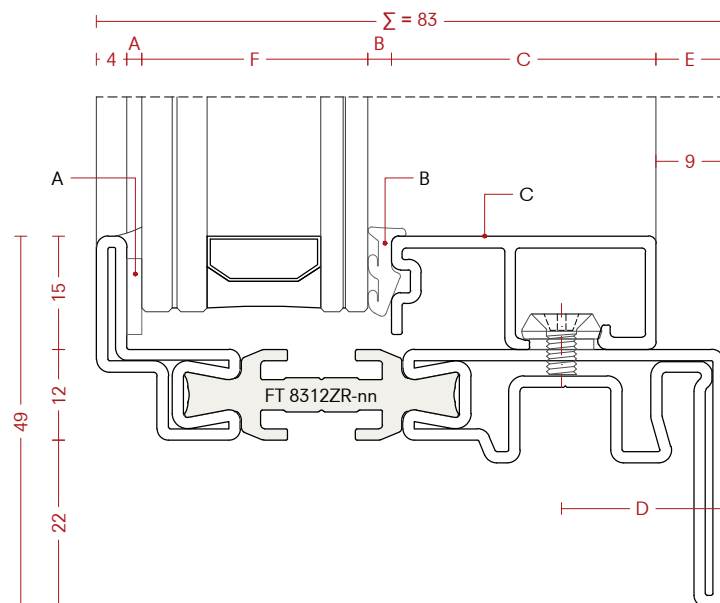
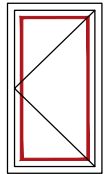
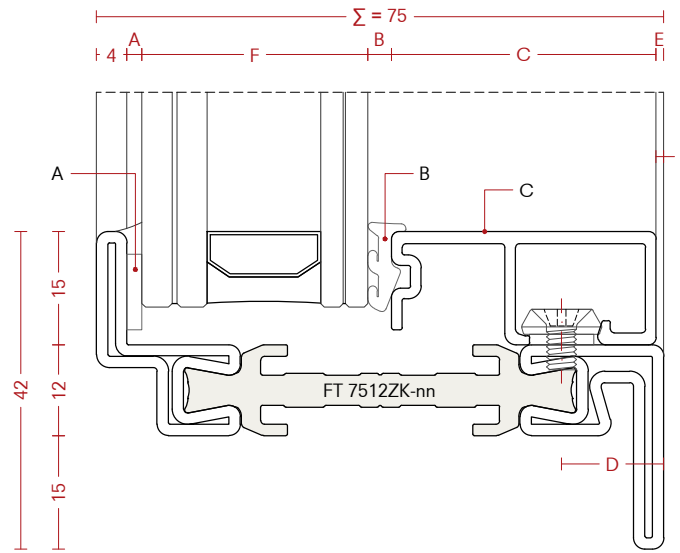
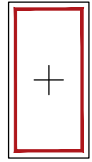
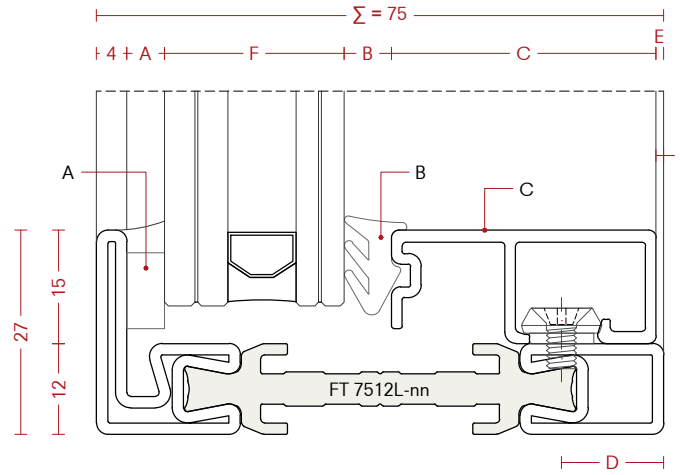

METALFORM

MASTERS OF METAL

UNITED KINGDOM

METALFORM

NORWAYMETAL LTD

53 Chelsea Manor Street

London, SW3 5RZ

SALES@METALFORM.UK

+44 20 81298814

GERMANY

METALFORM GMBH

Carl-Zeiss-Ring 15A

85737 Ismaning

SALES@METALFORMGROUP.DE

+49 17663630406

NORWAY

METALFORM AS

Brochmannsveien 2

1950 Rømskog

SALG@METALFORM.NO

+47 401 62 446

METALFORMGROUP

SALES@METALFORMGROUP.COM