

Examples

Beispiele

Exemples

4.0

Window details
Door details
Details, structural connections
Wall connections

Details Fenster
Details Türen
Details Konstruktion
Bauanschlüsse

Détails fenêtres
Détails portes
Détails de construction
Détails de raccords au mur

4.1
4.2
4.3
4.4

Window details

Details Fenster

Détails fenêtres

4.1

Legend

+ = Fixed
— = Open in
- - - = Open out
Dimensions in: mm
Scale 1:1 - 1:2

Legende

+ = Fixed
— = Innen öffnend
- - - = Außen öffnend
Einheit in: mm
Maßstab 1:1 - 1:2

Légende

+ = Fixe
— = Ouvr. intérieur
- - - = Ouvr. extérieur
Dimensions en: mm
Échelle 1:1 - 1:2

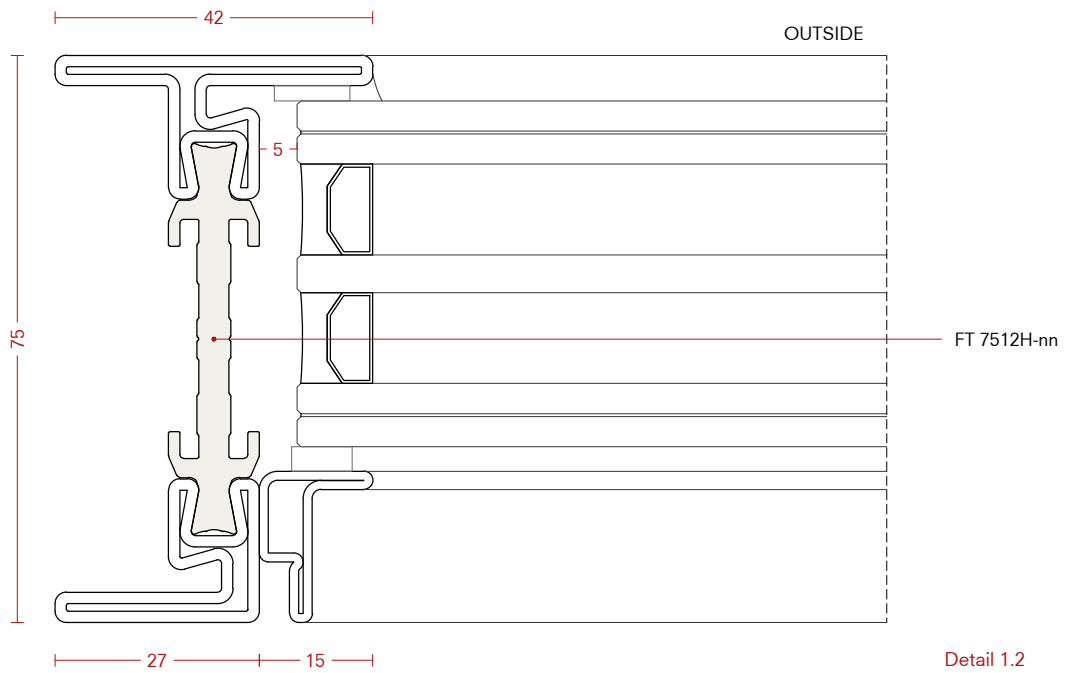
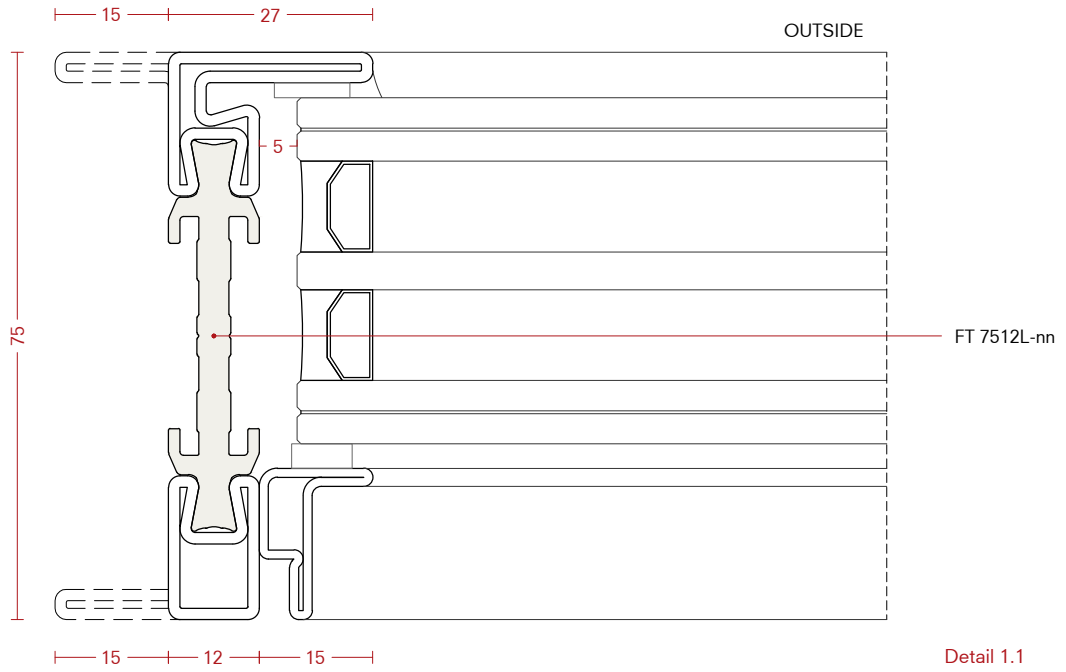
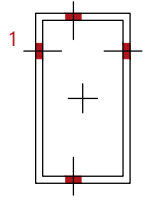

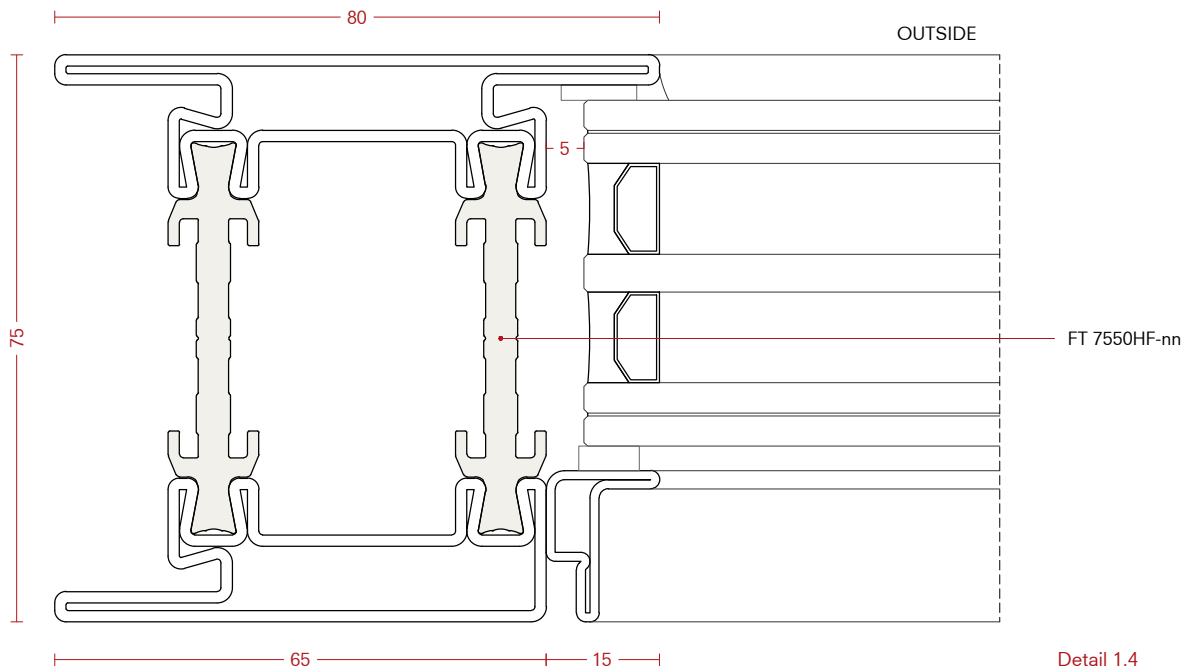
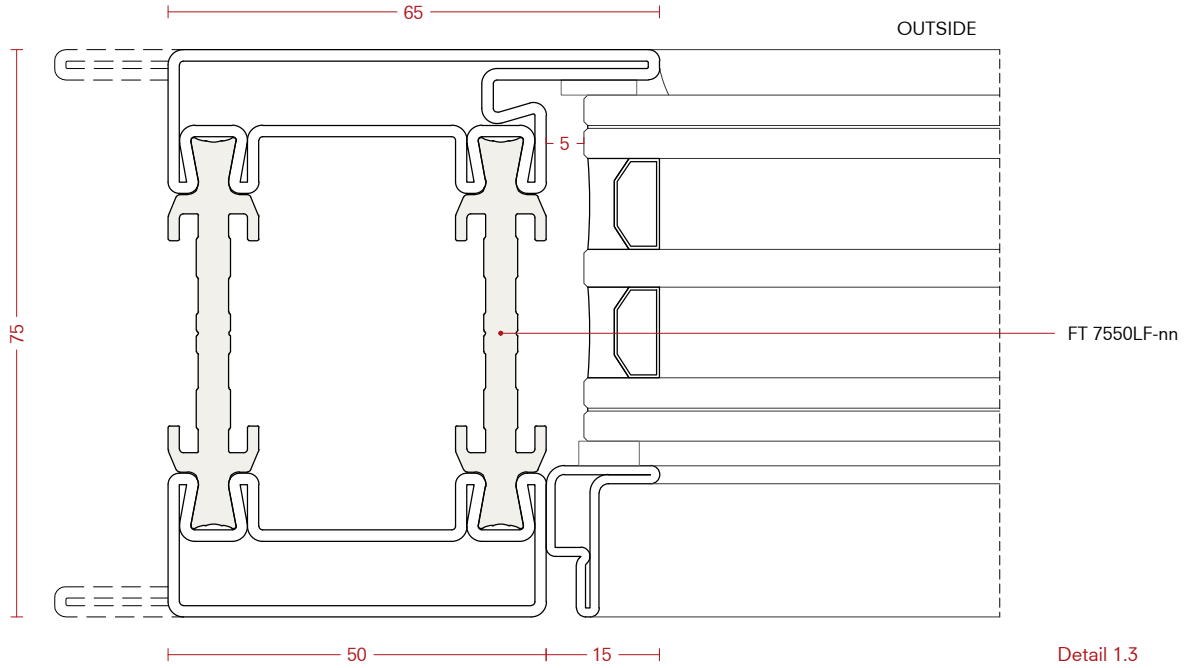
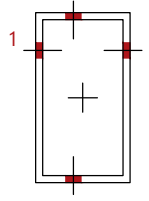

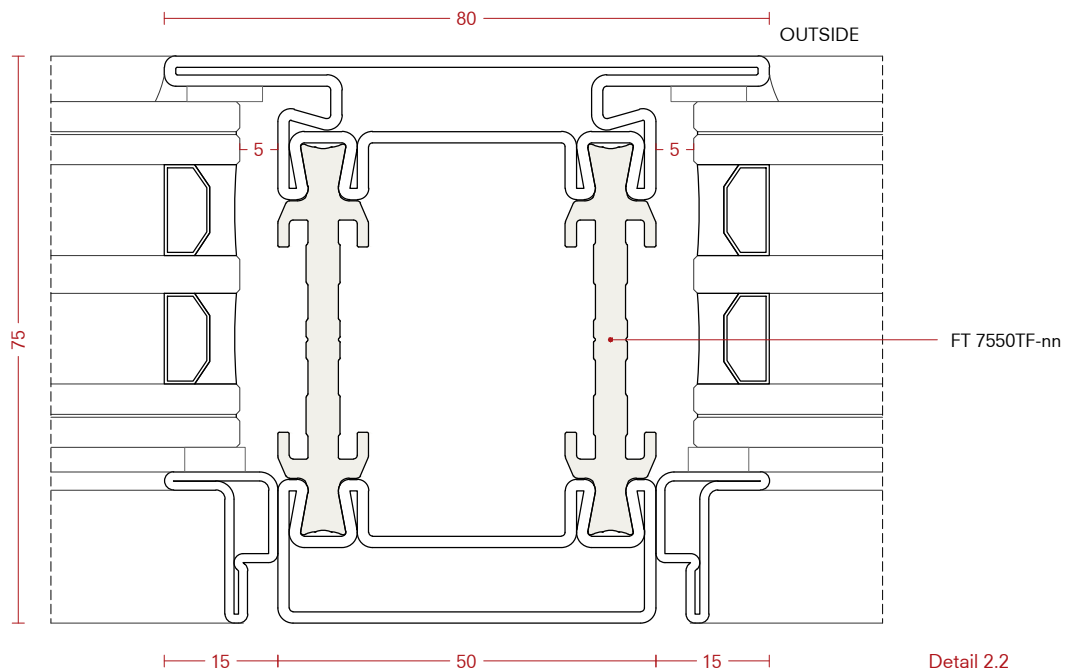
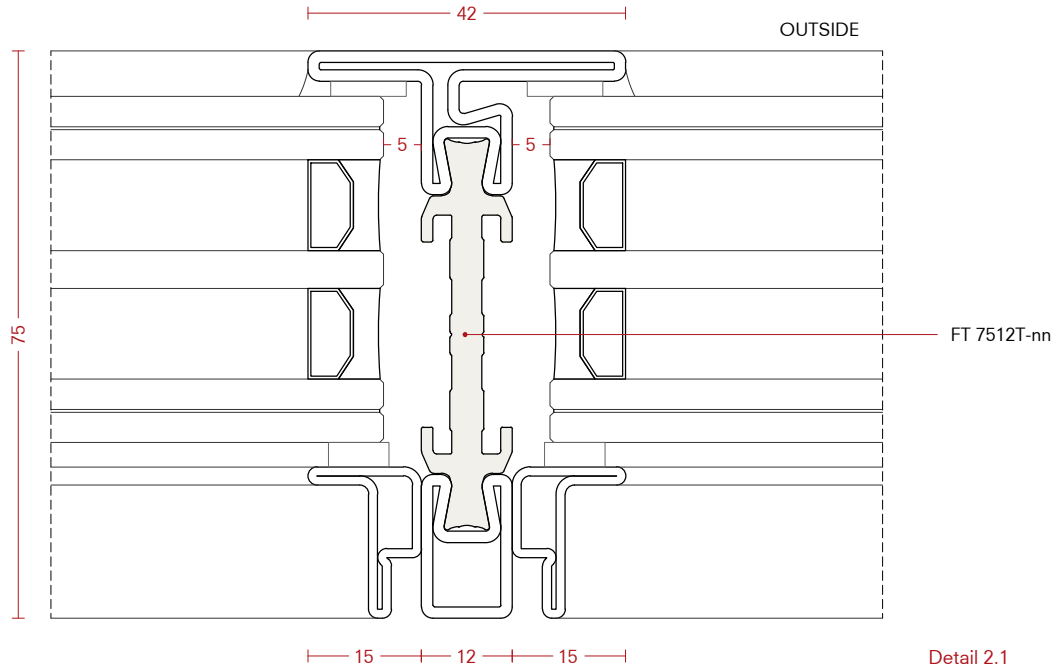
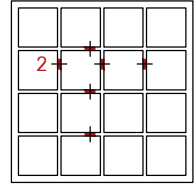

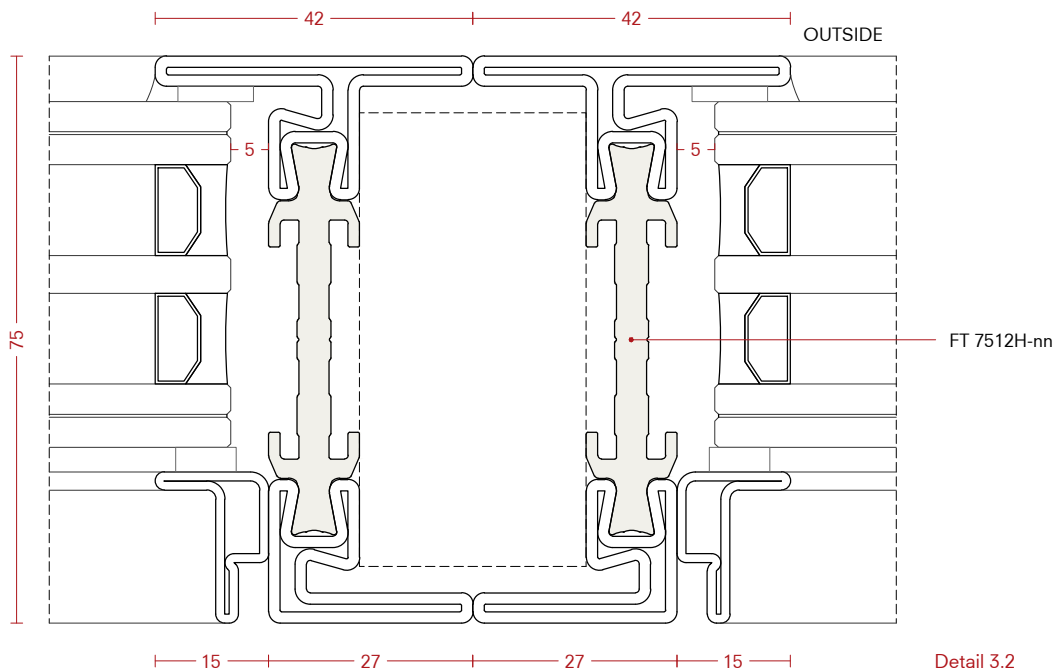
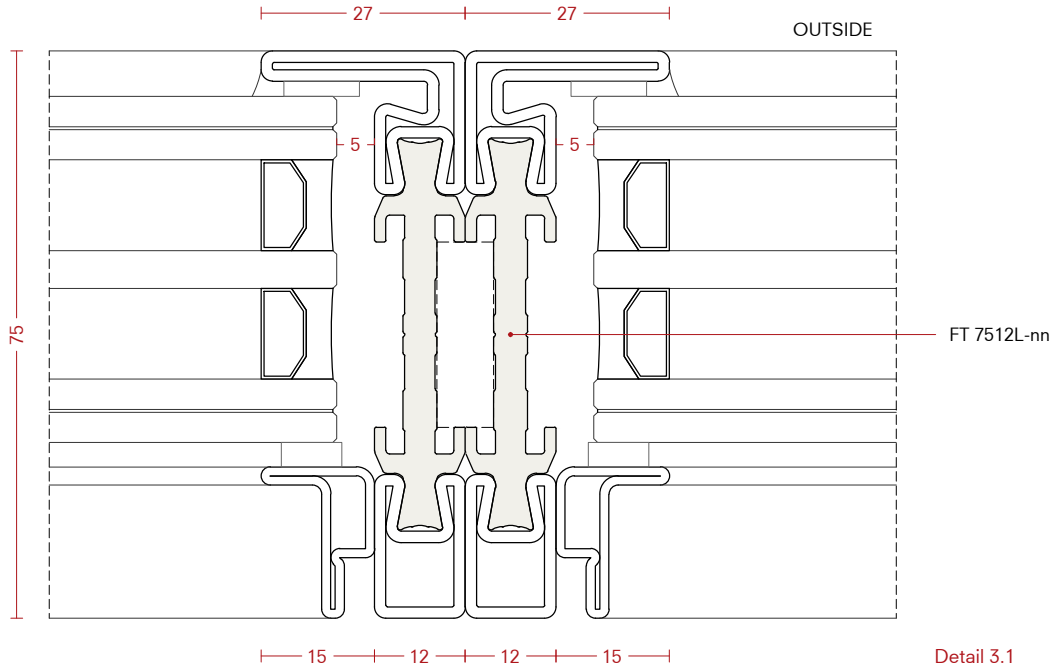
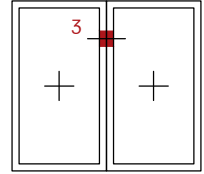

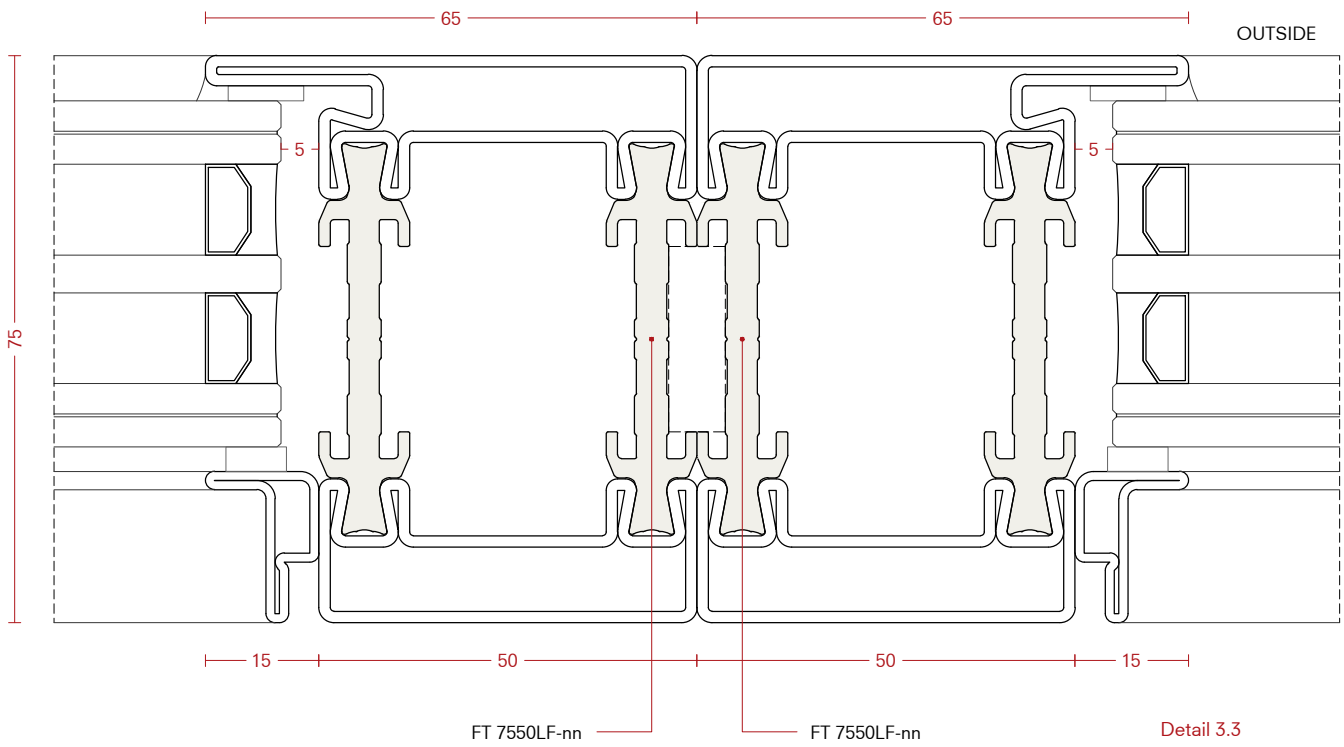
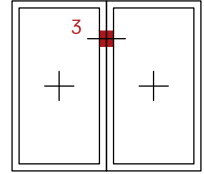

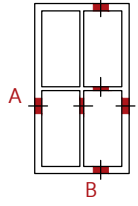

A

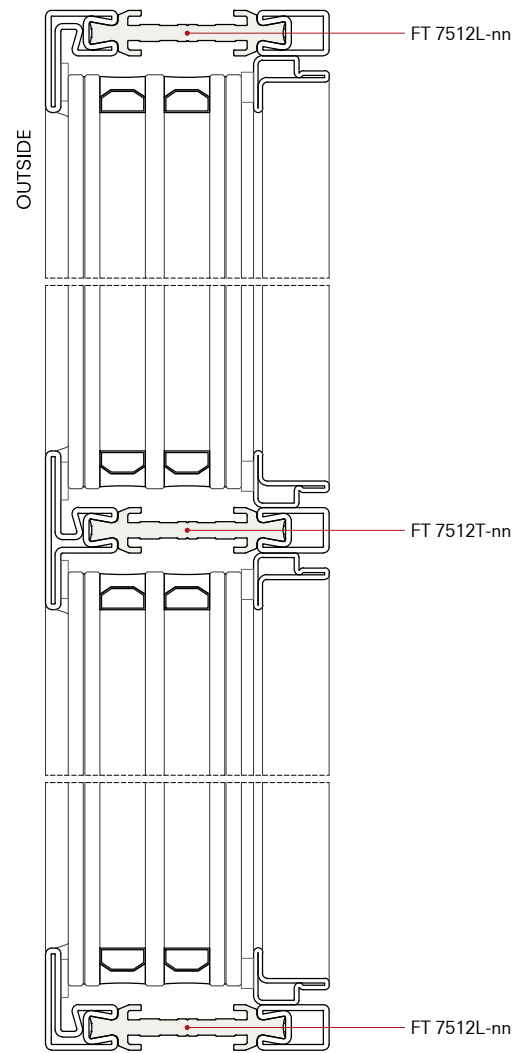
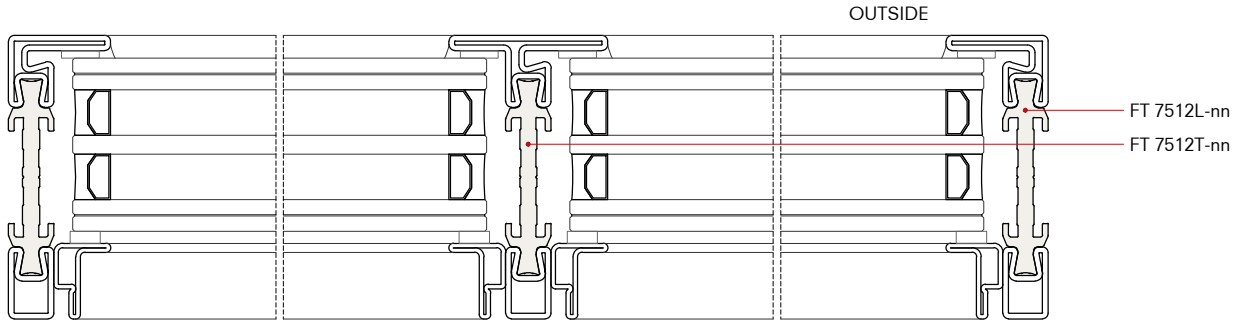

B

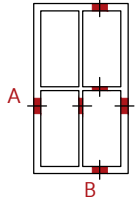

A

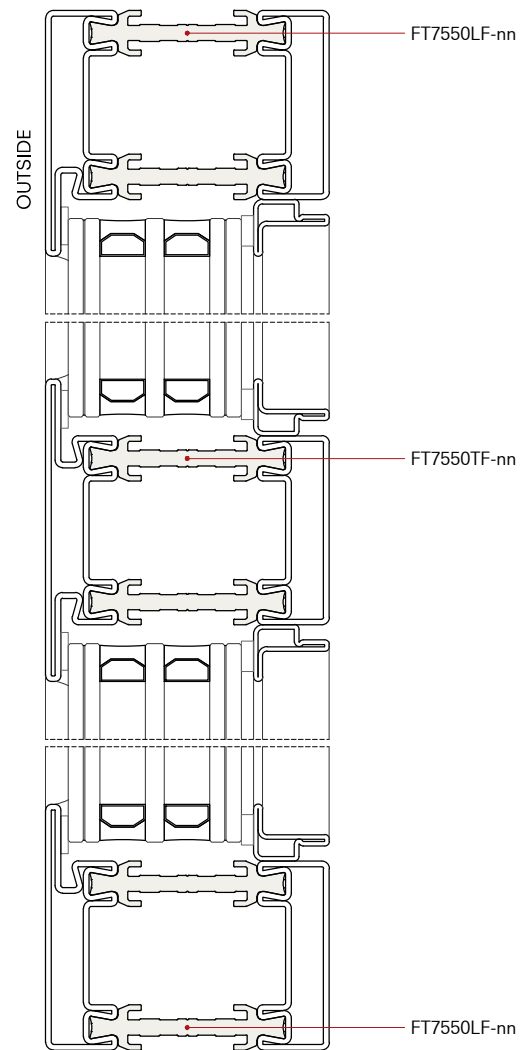
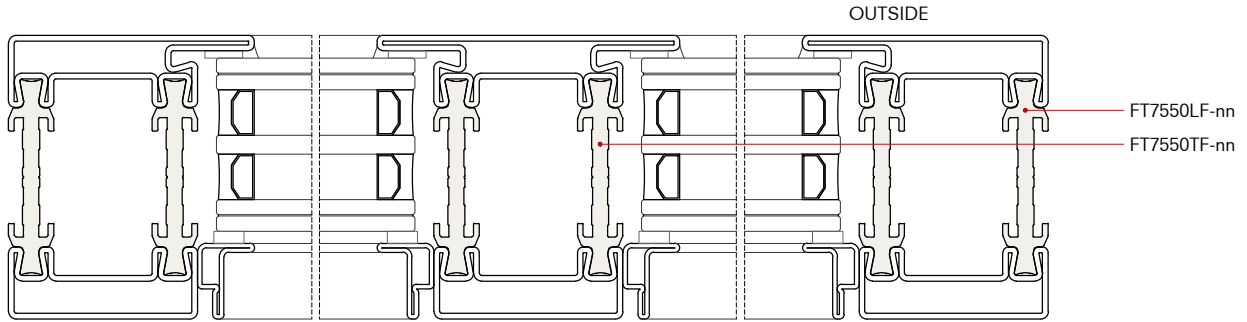

B

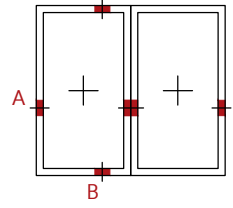

A

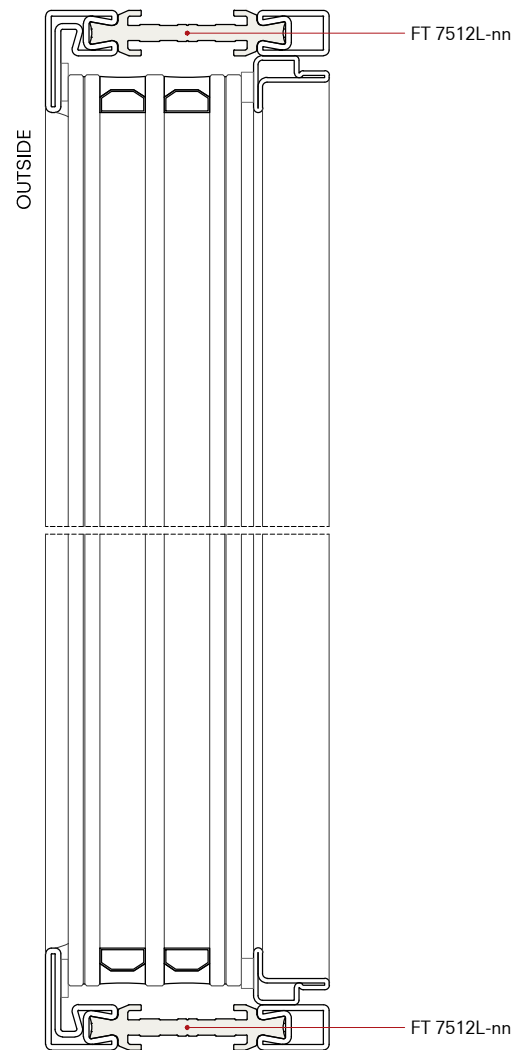
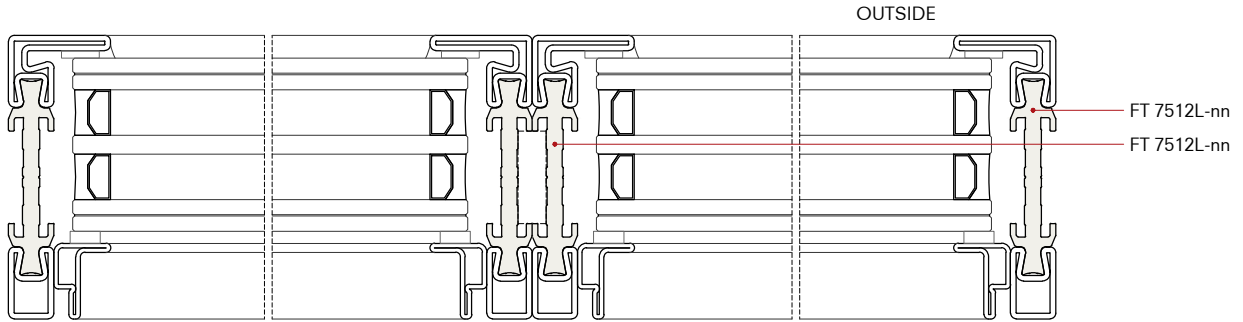

B

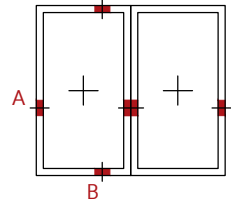

A

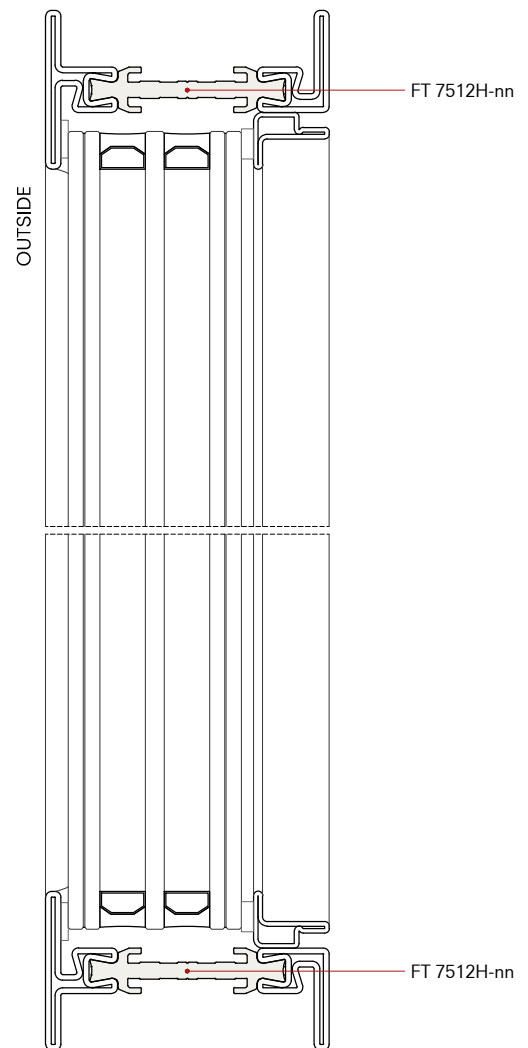
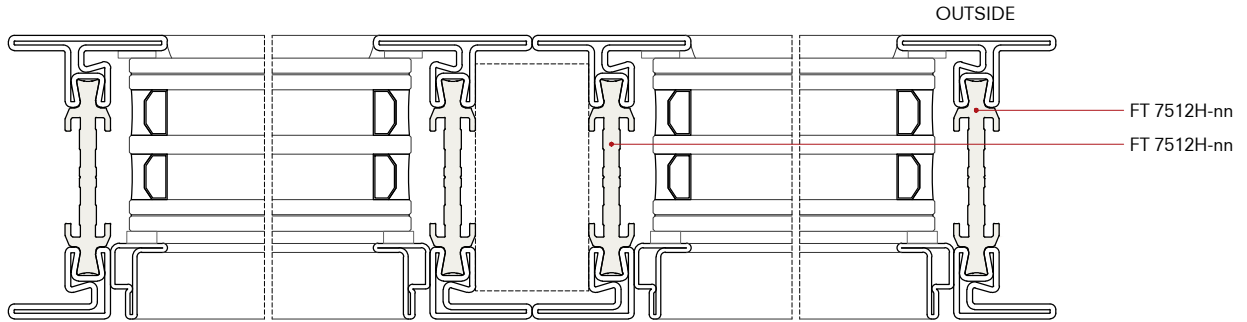

B

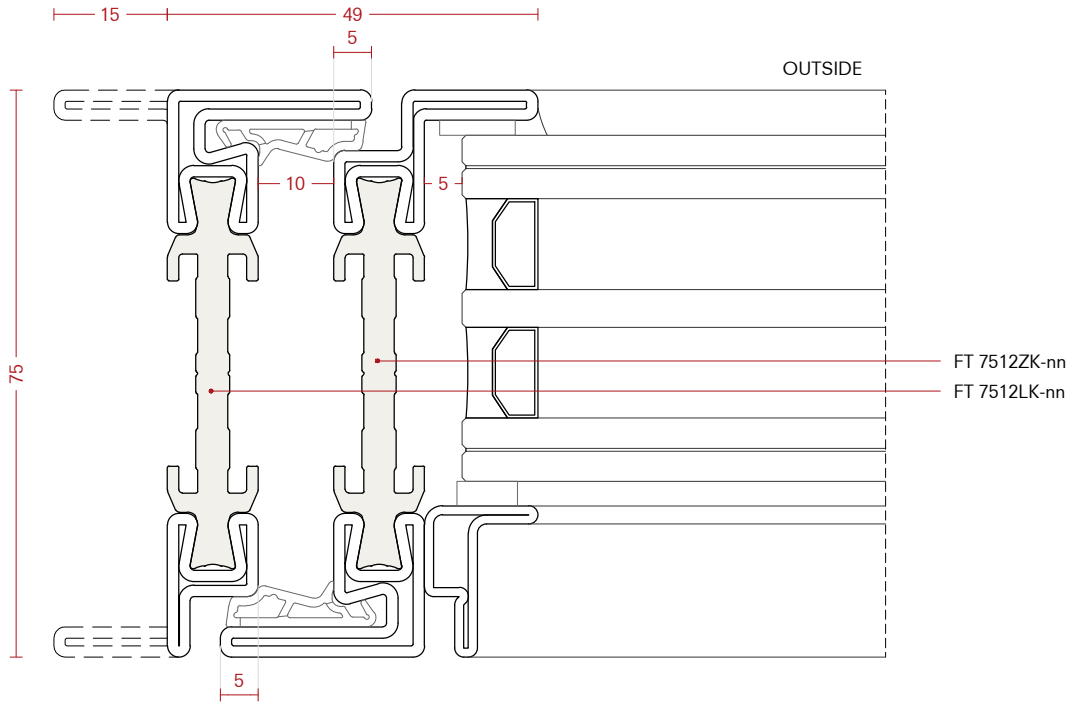
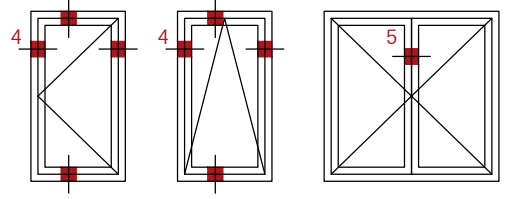

Detail 4.1

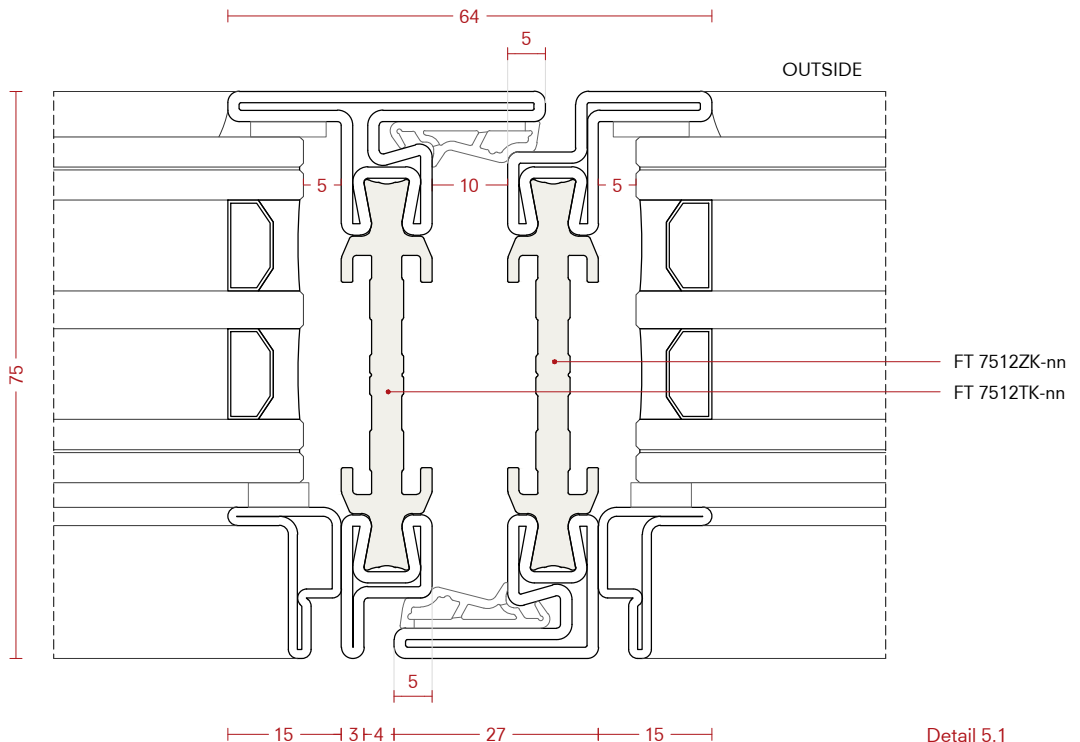

Detail 5.1

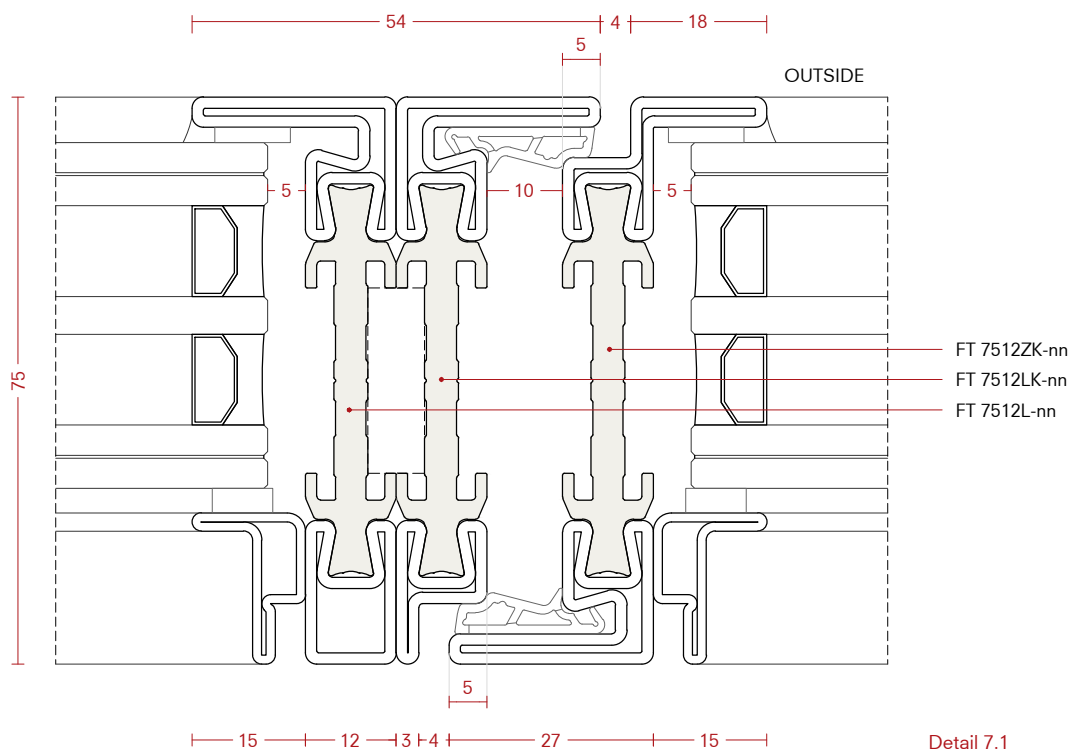
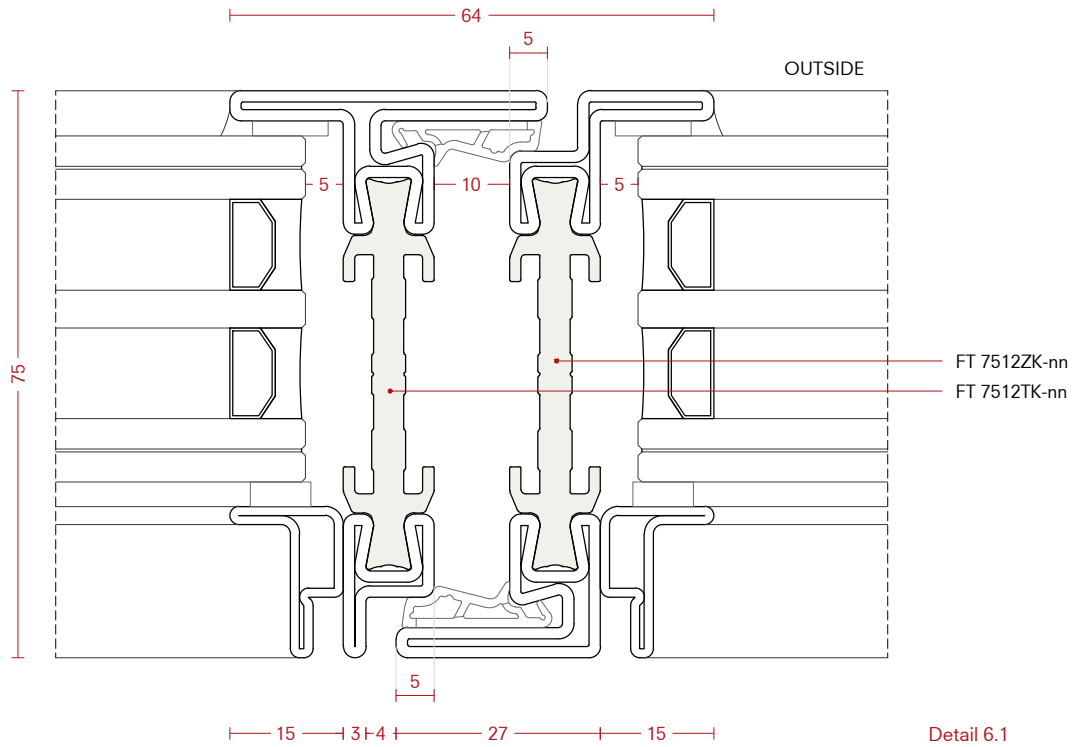
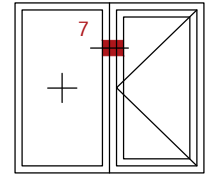
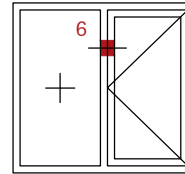

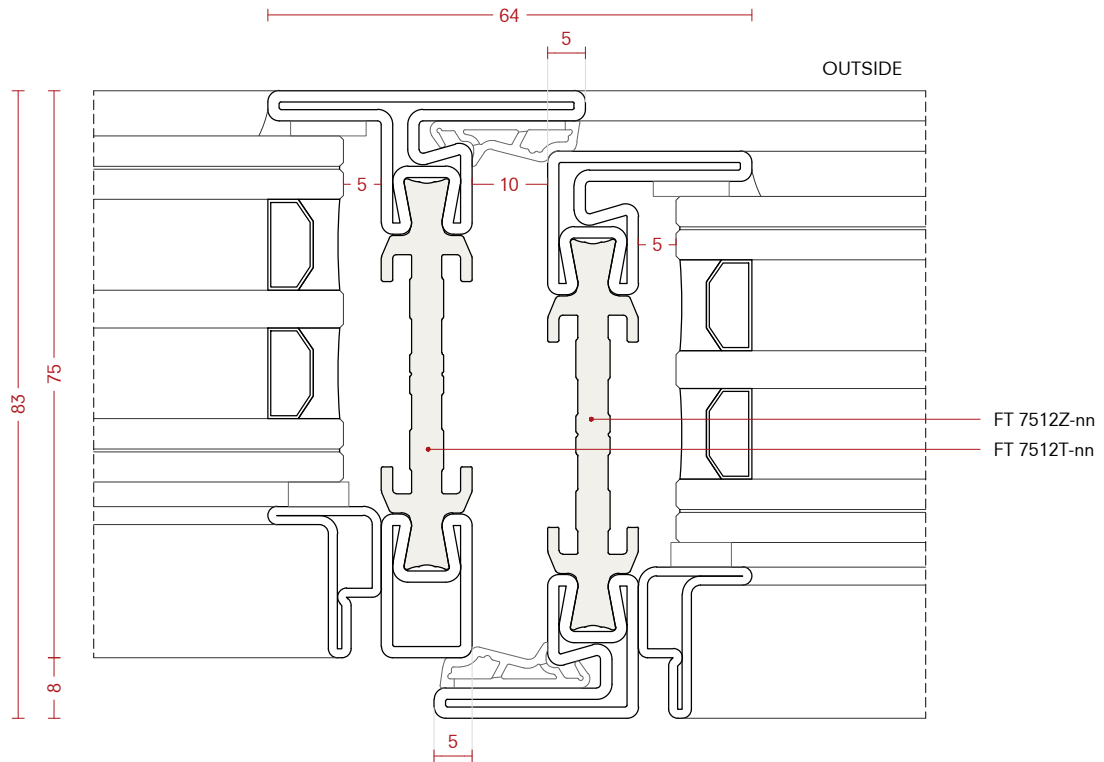
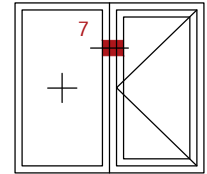
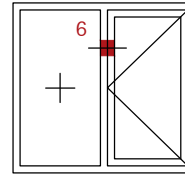

Detail 6.2

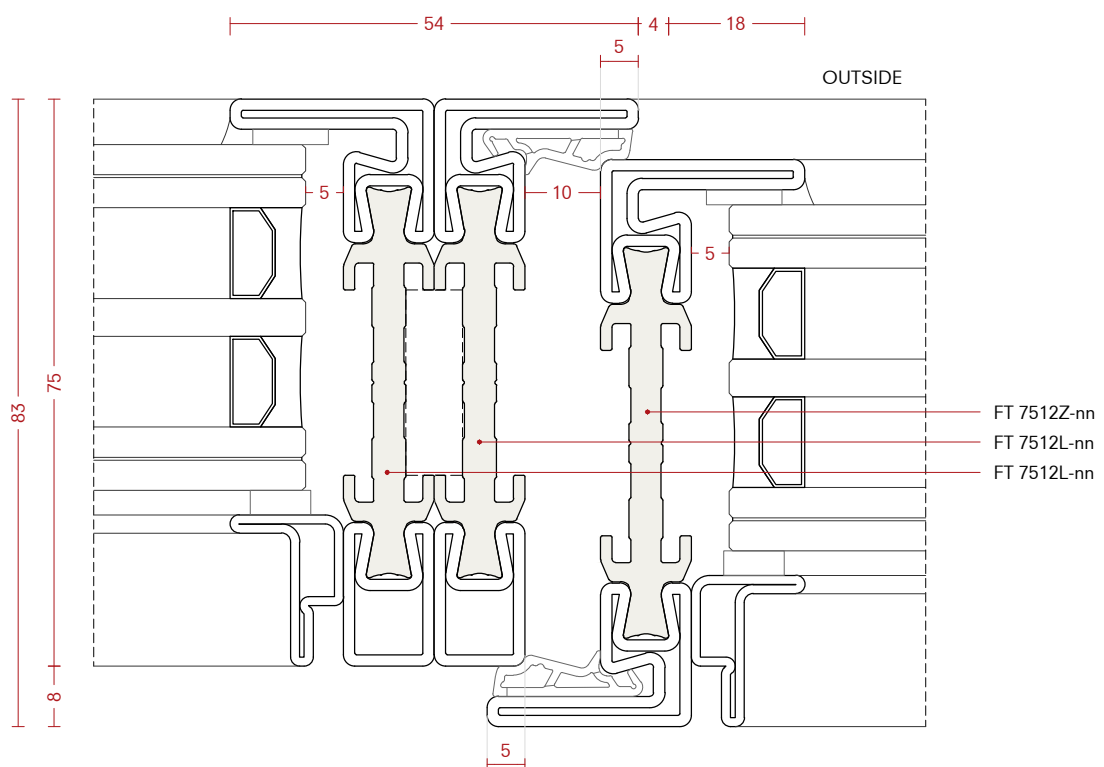

Detail 7.2

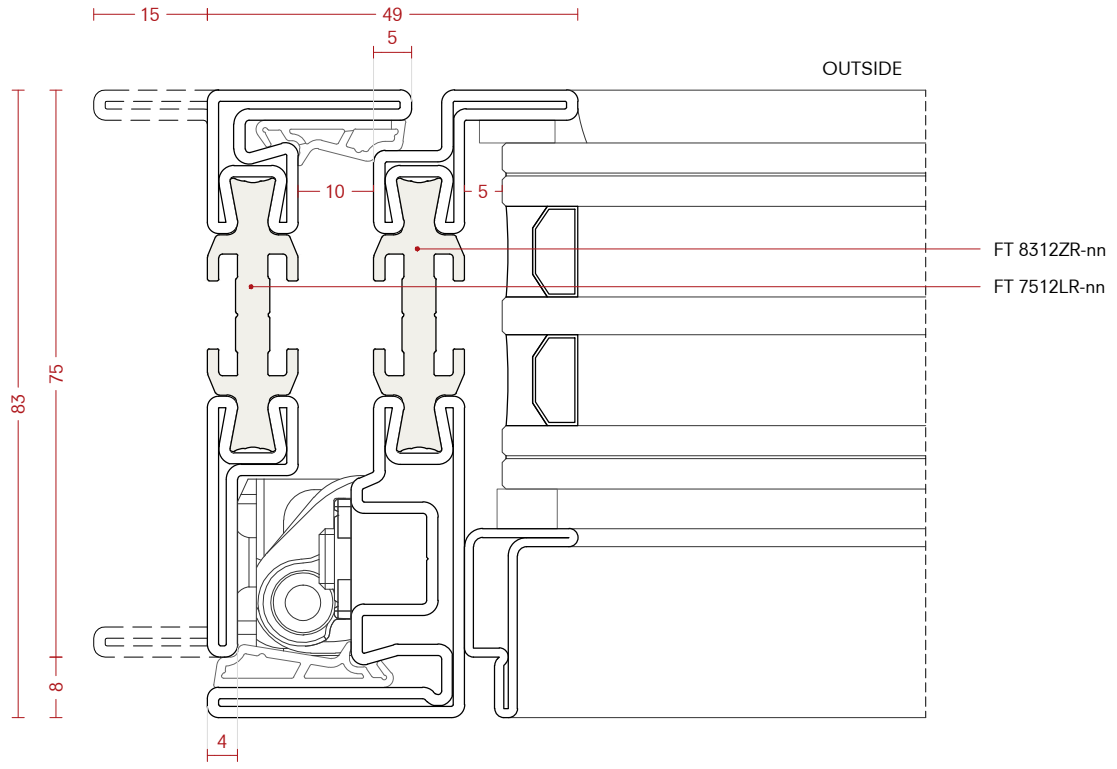
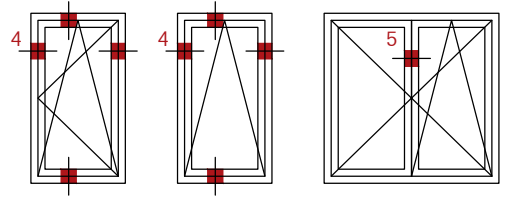

Detail 4.3

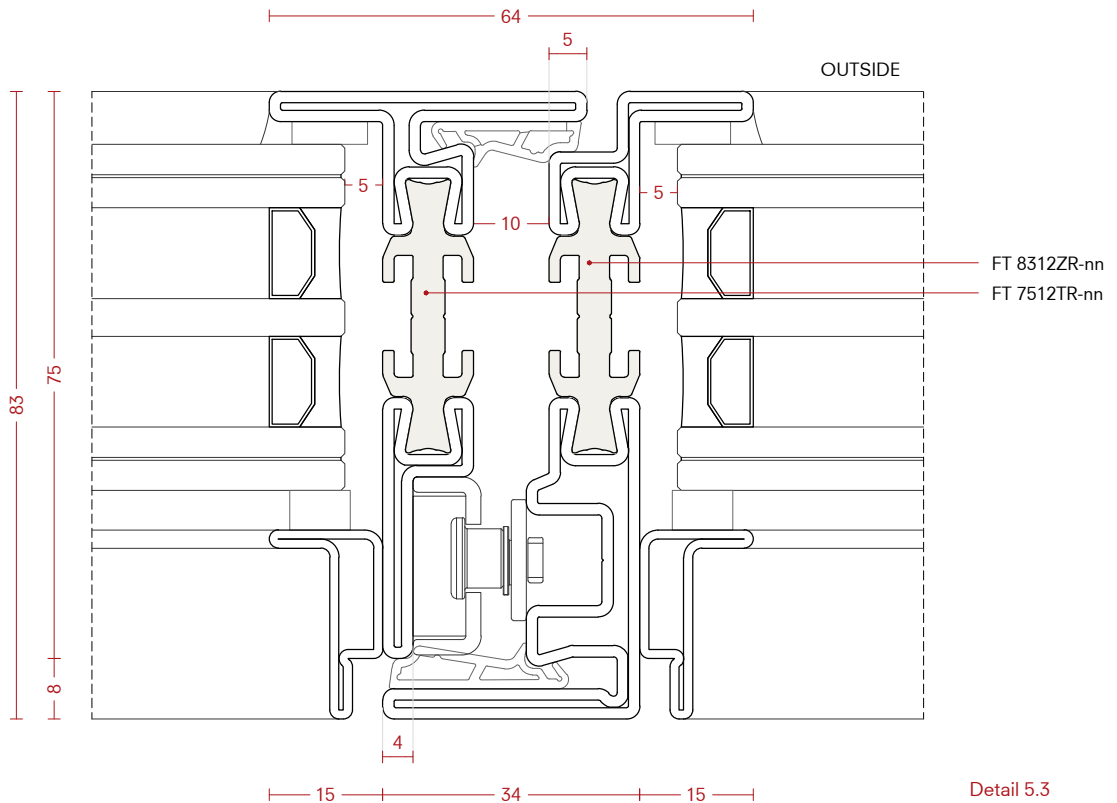

Detail 5.3

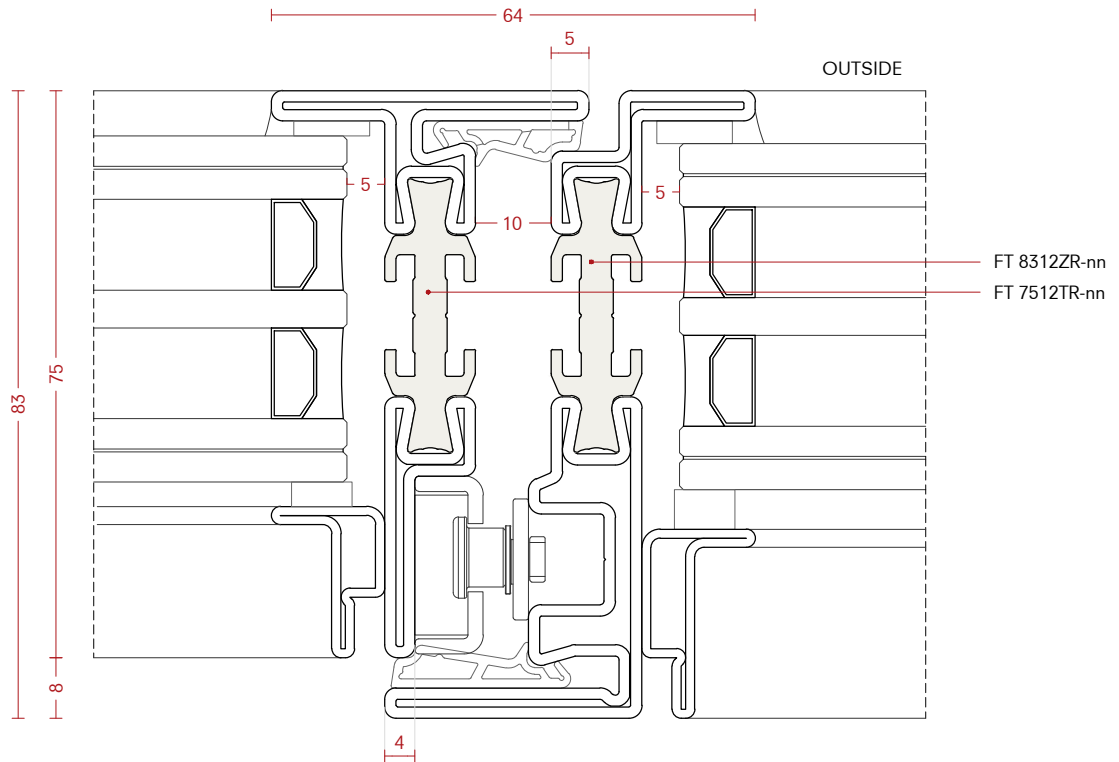
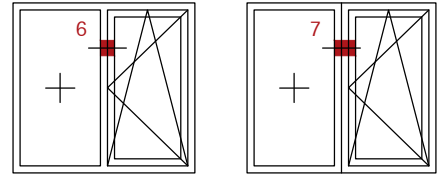

Detail 6.3

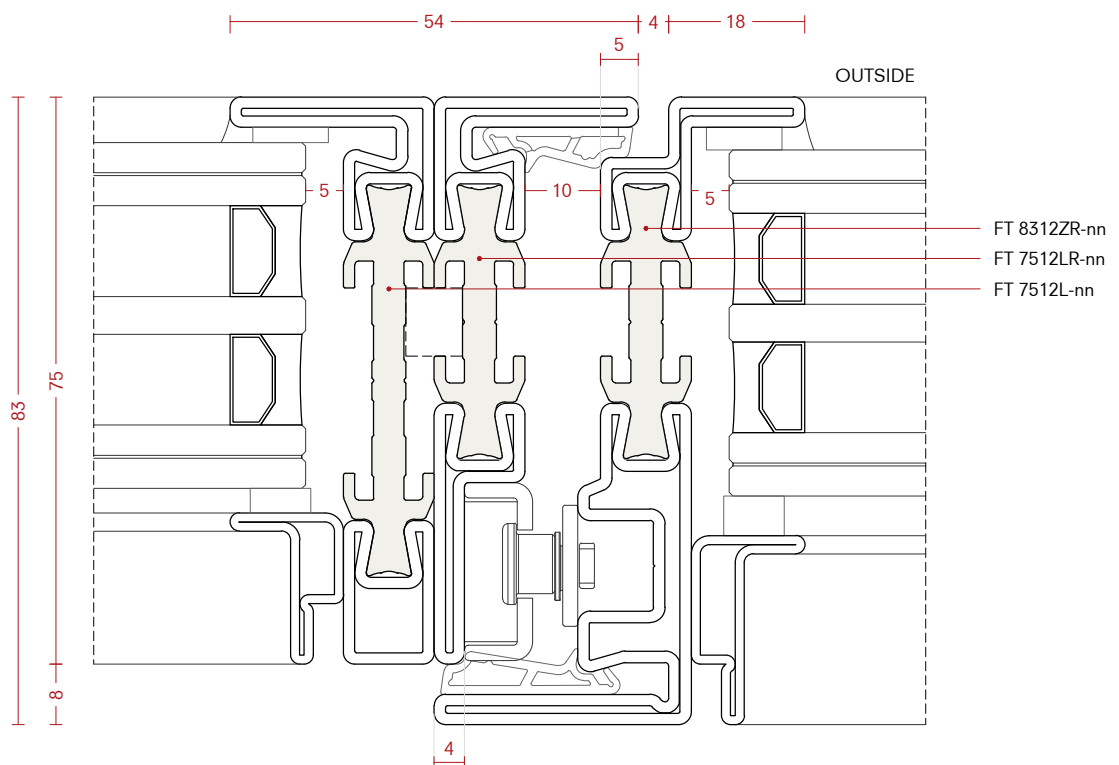

Detail 7.3

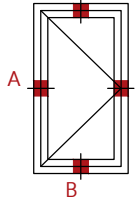

A

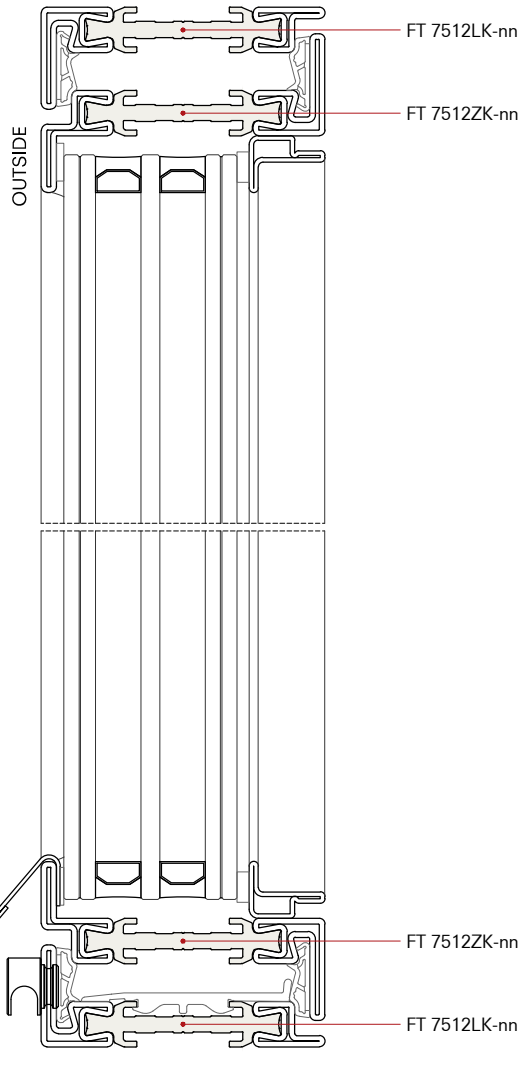
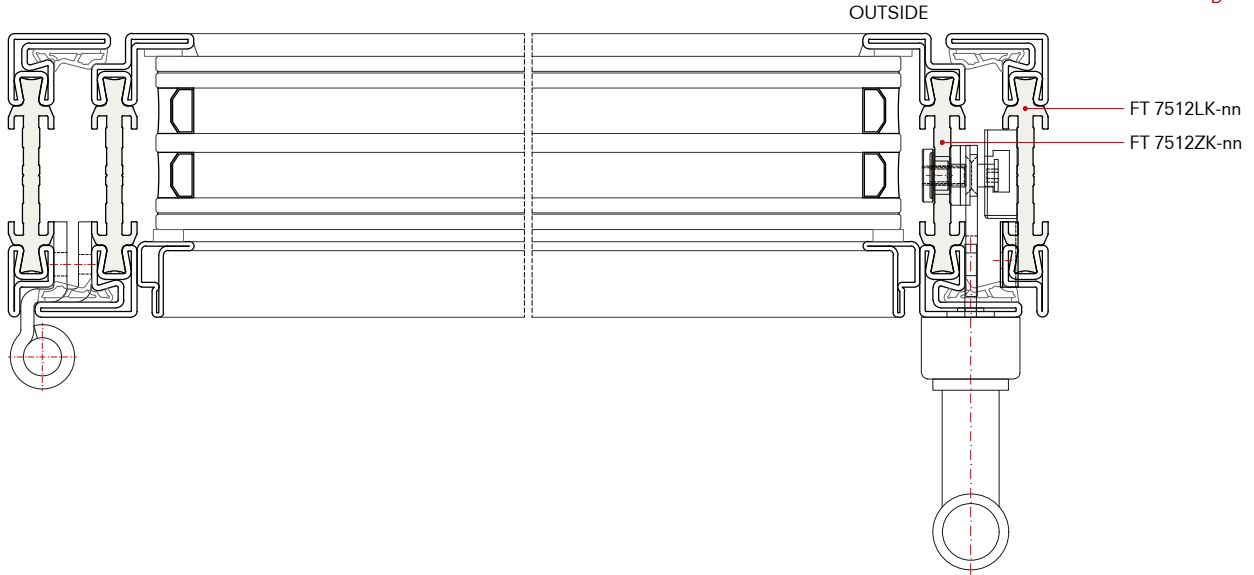

B

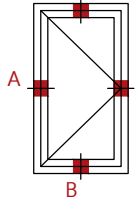

A

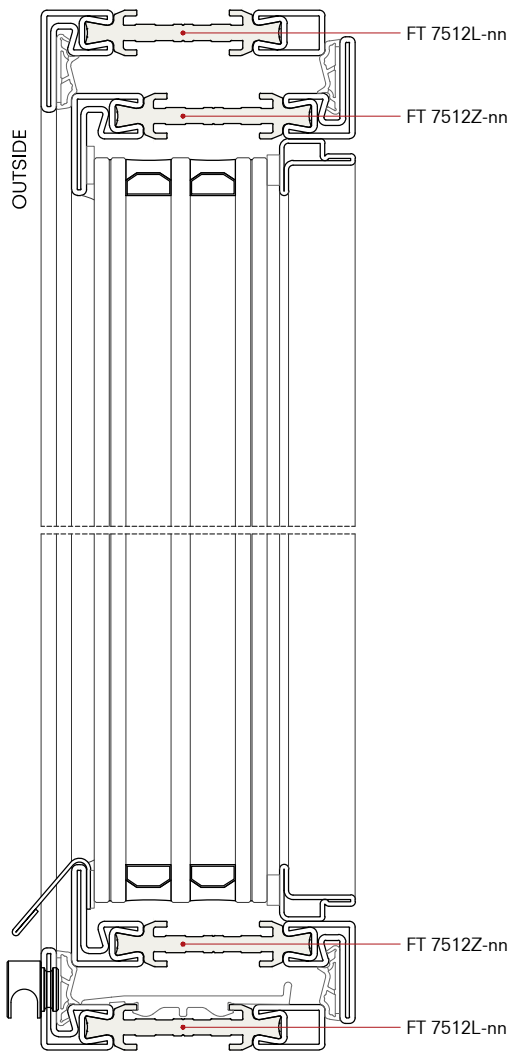
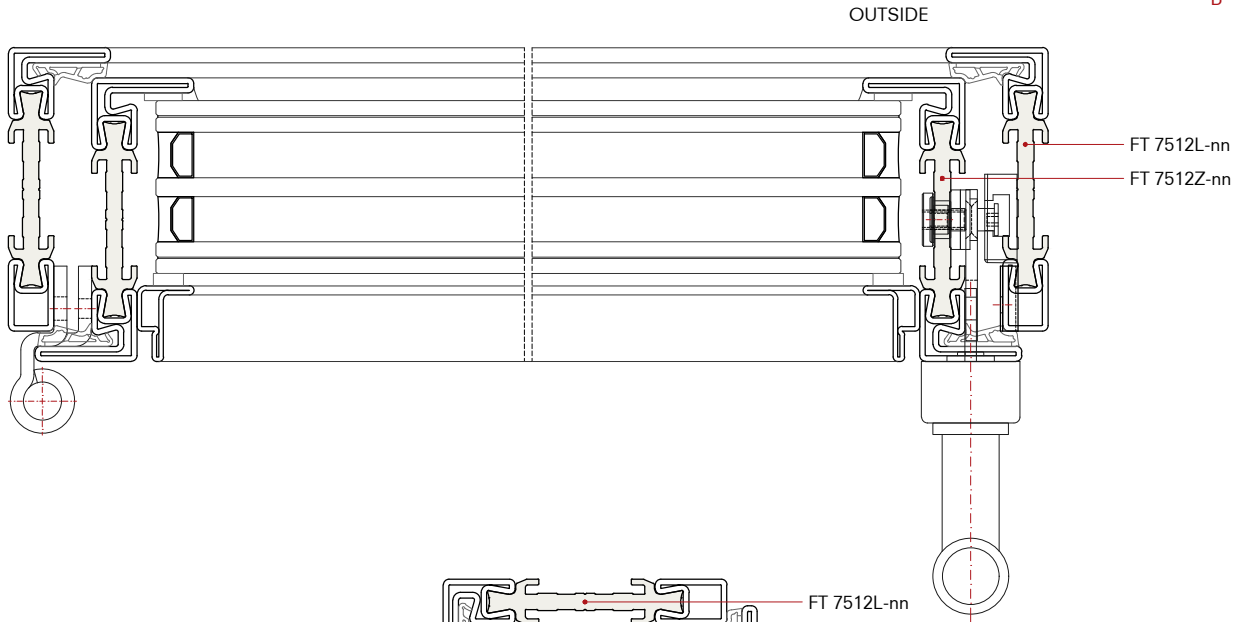

B

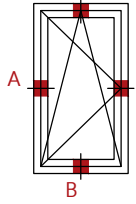

A

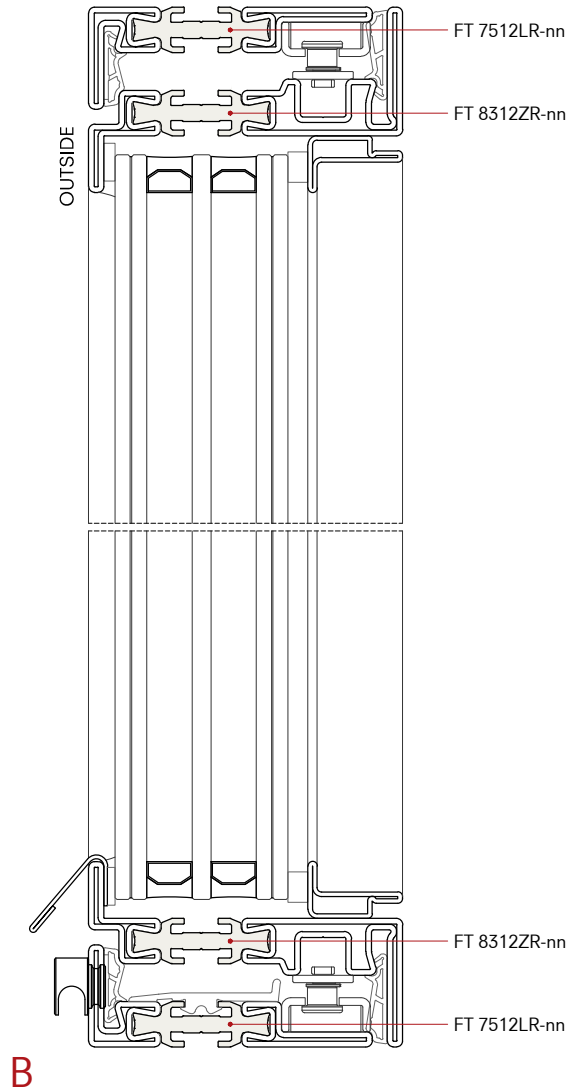
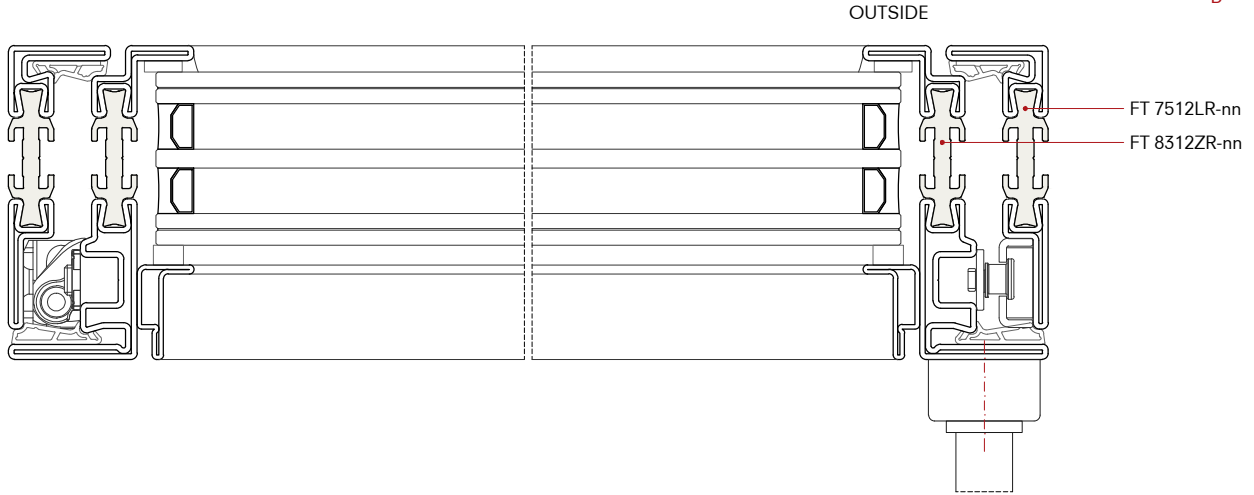

A

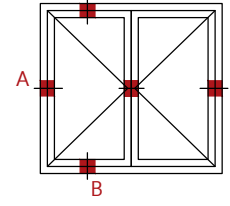
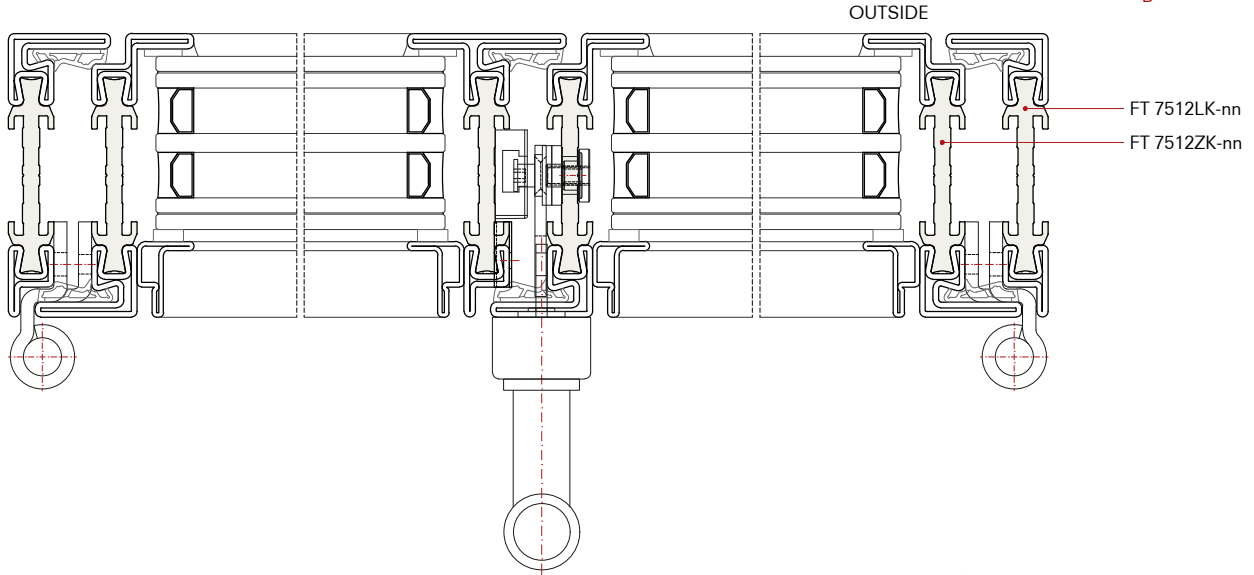

B

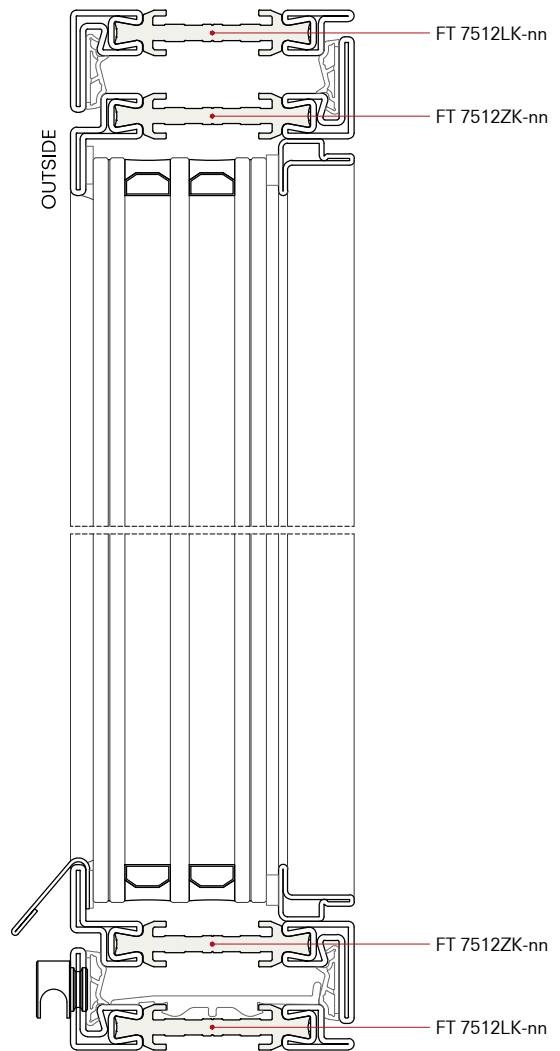

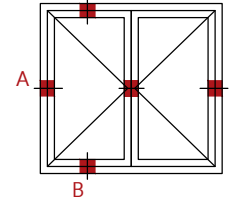

A

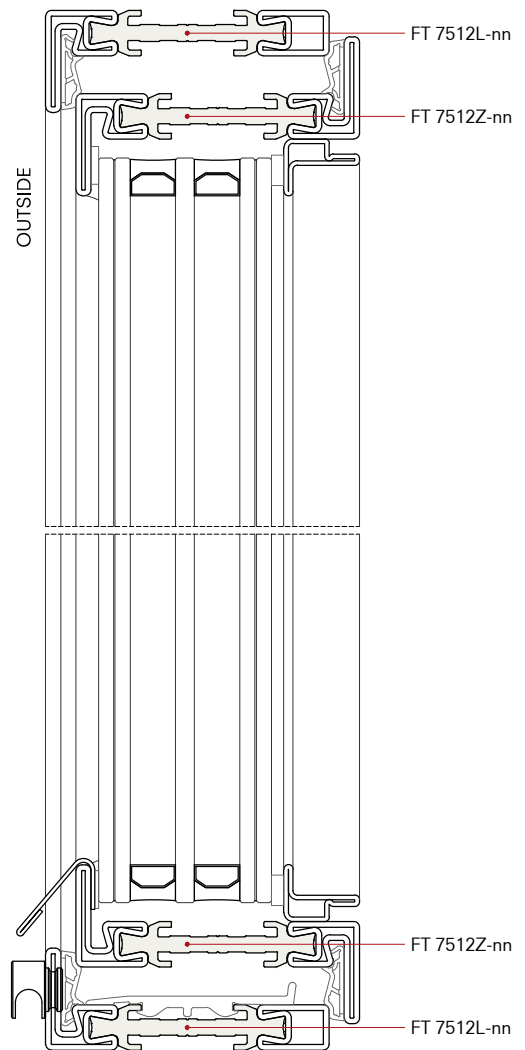
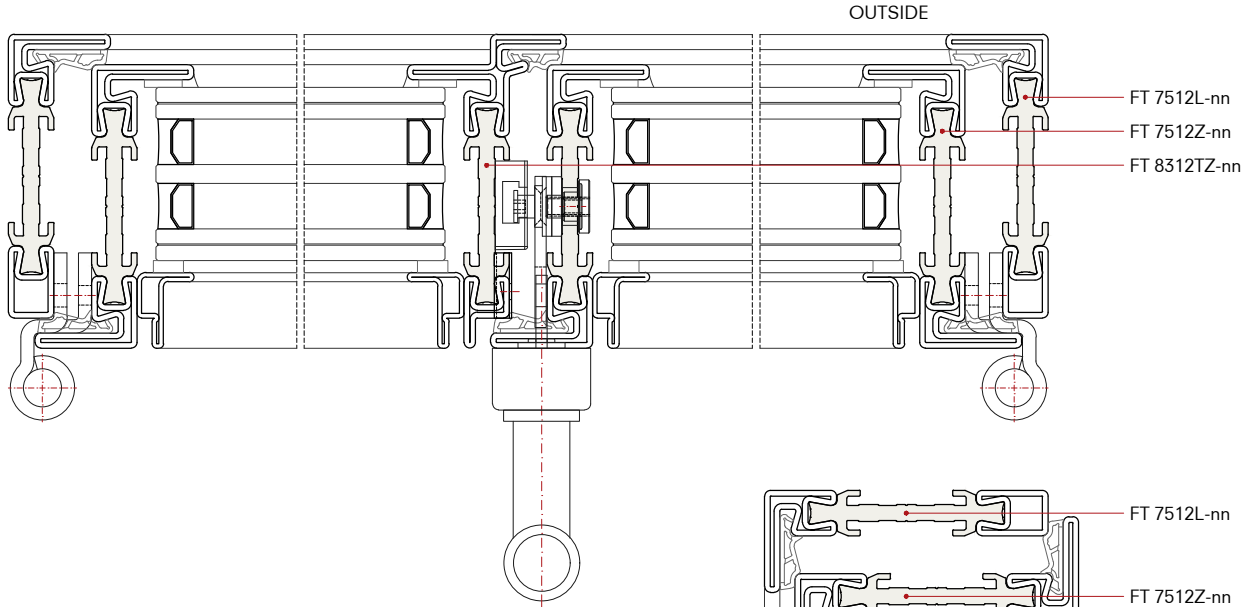

B

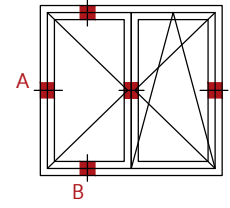

A

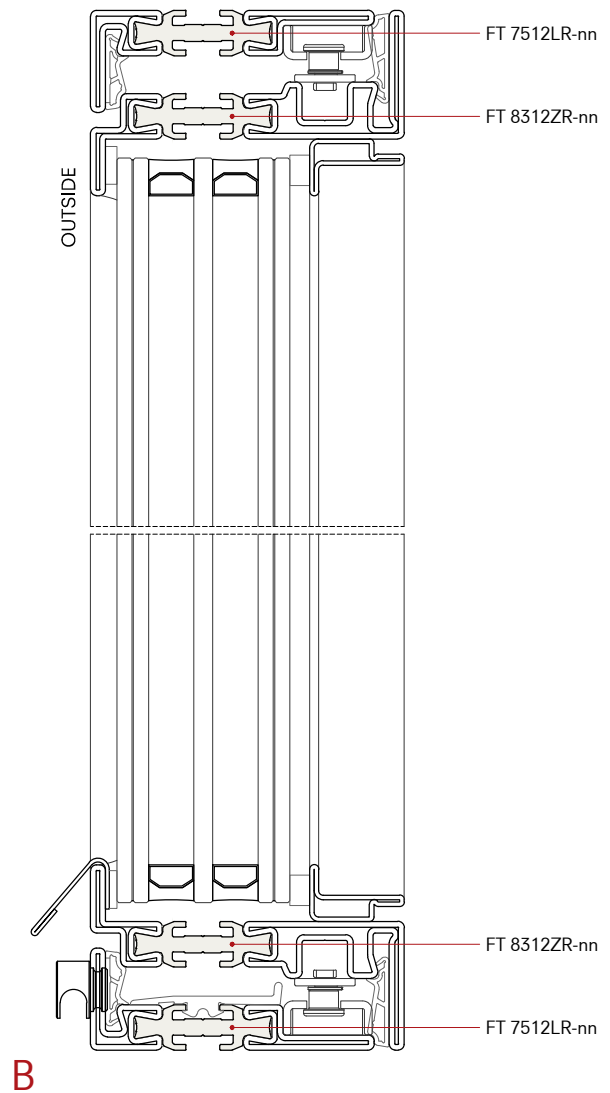
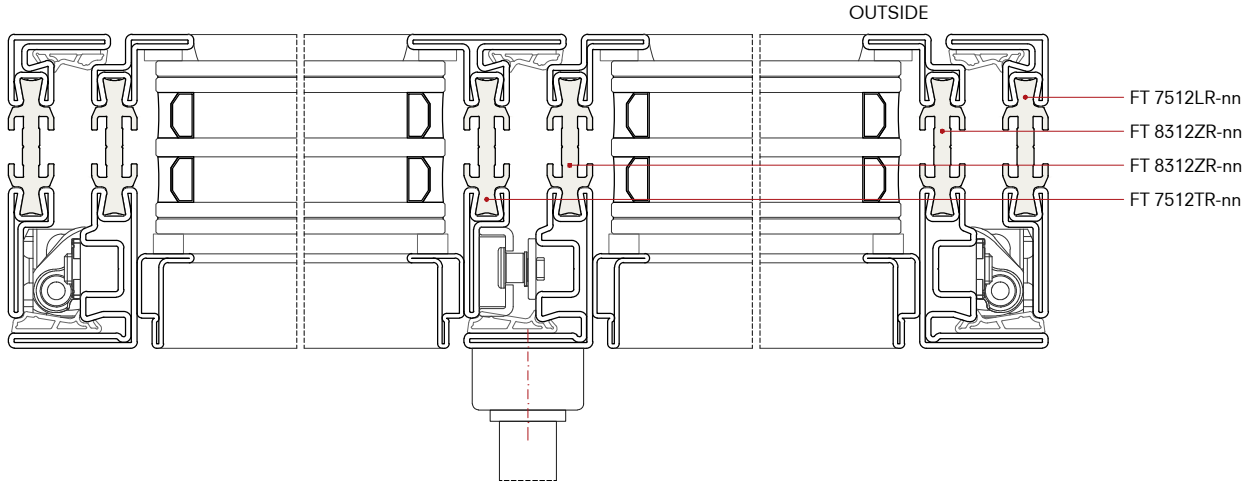

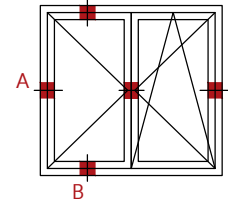

A

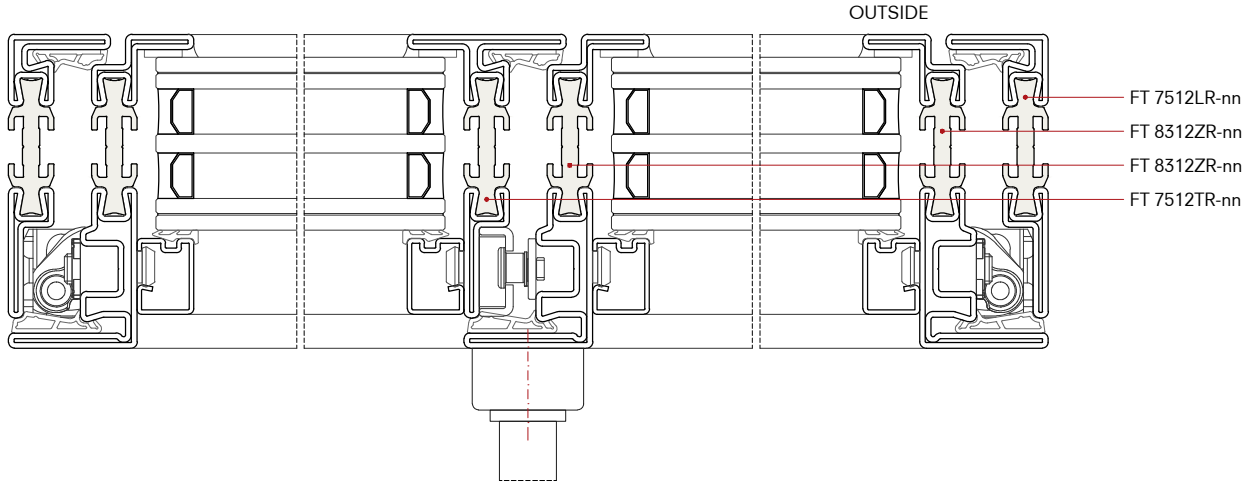

B

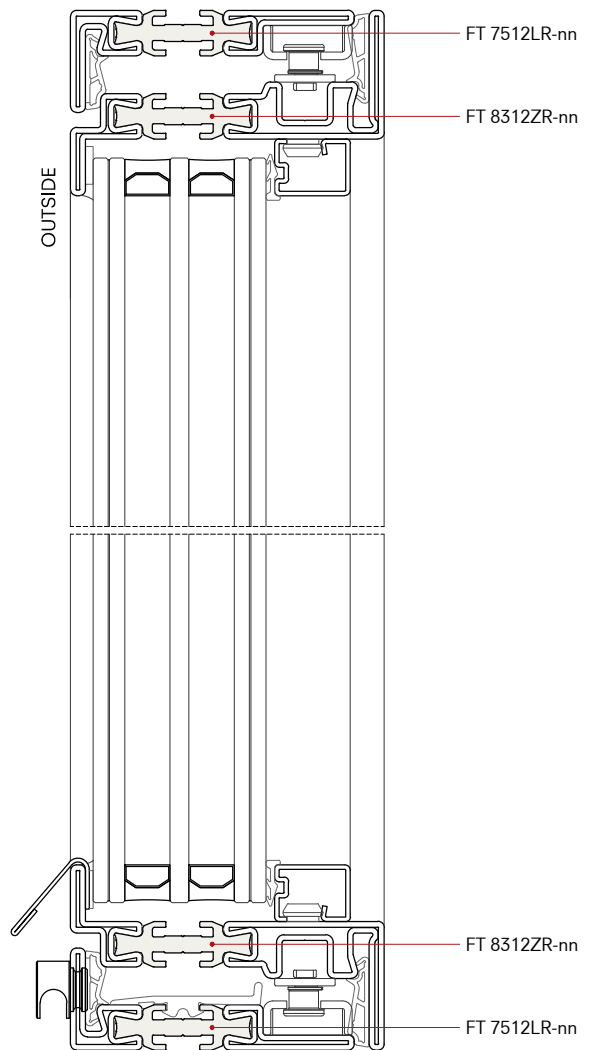

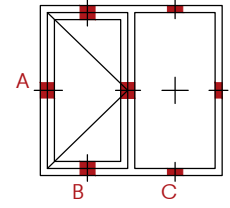

A

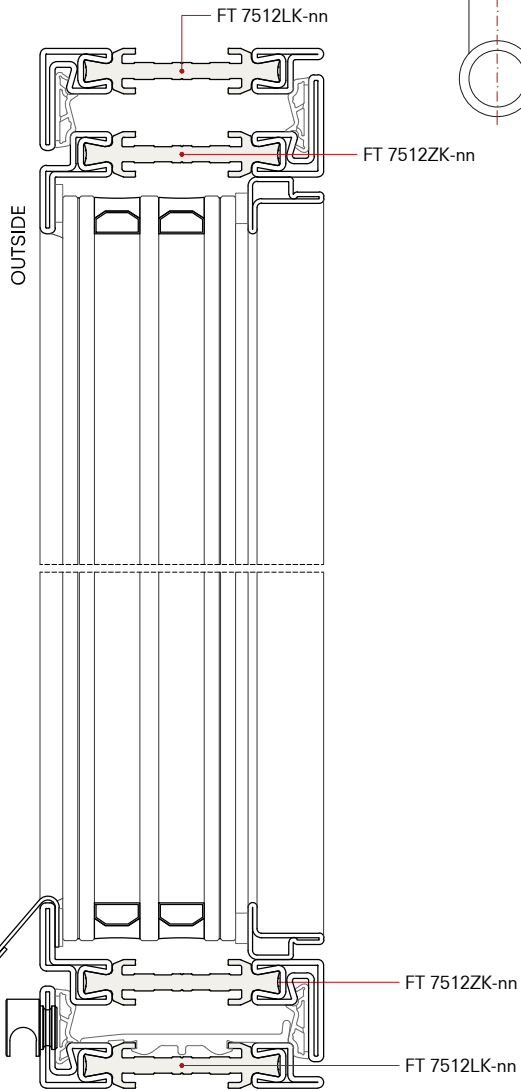
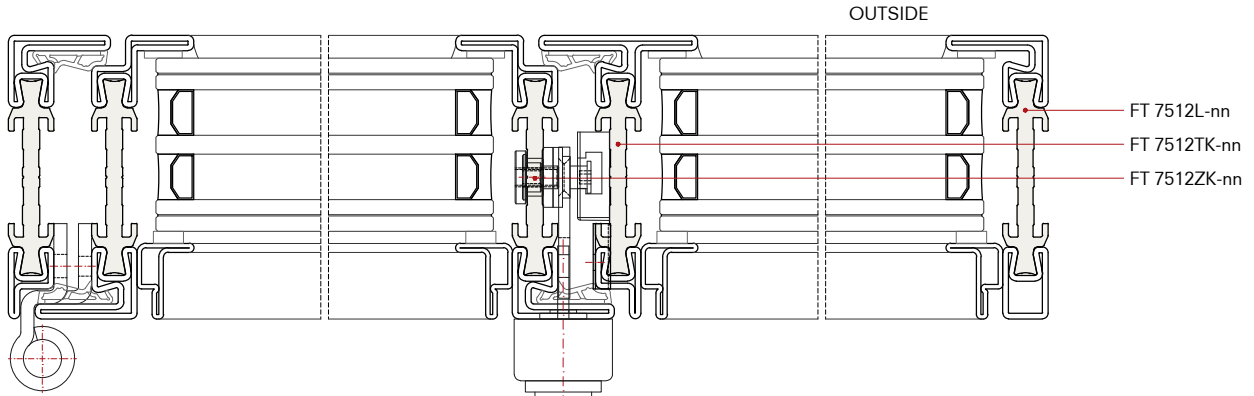

B

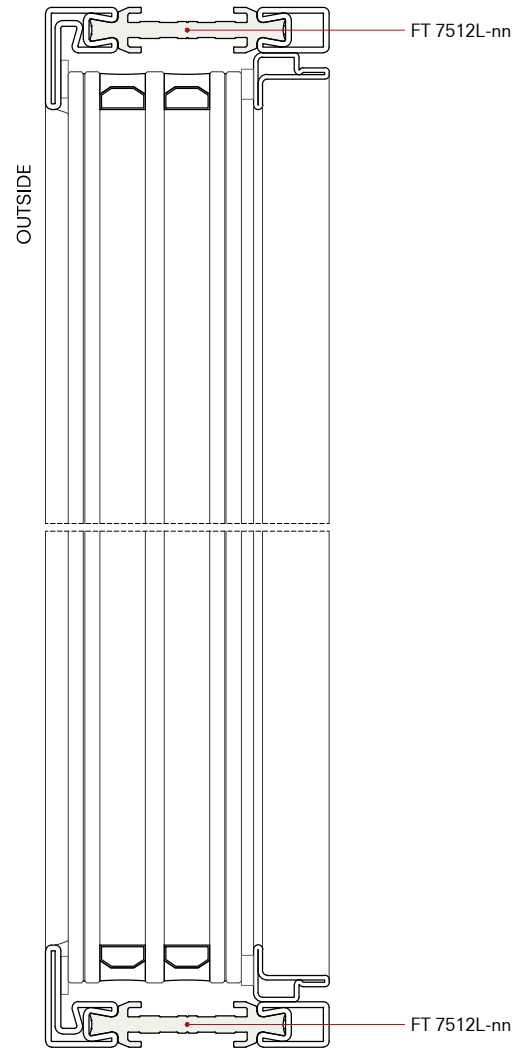

C

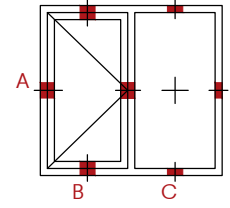

A

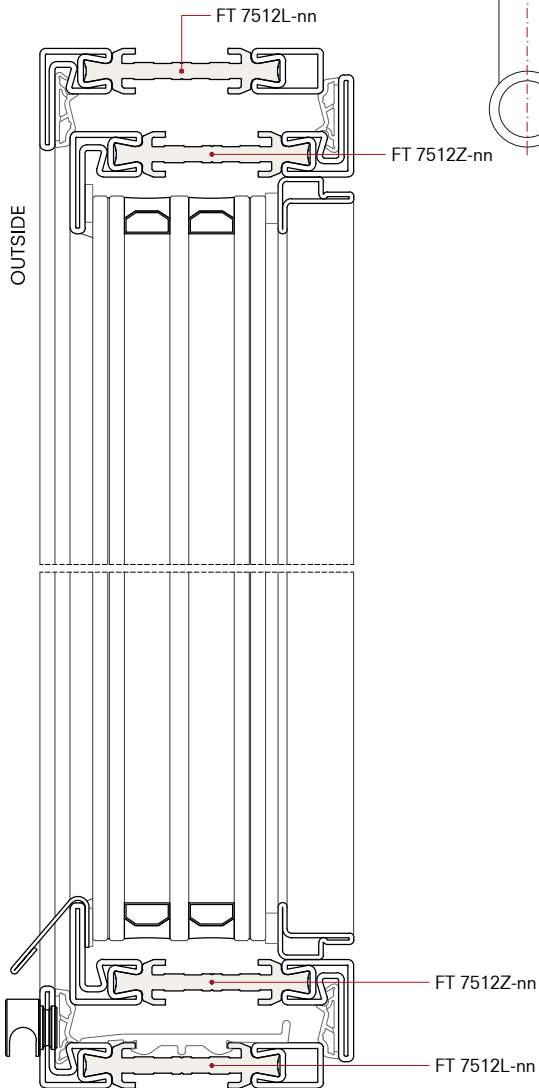
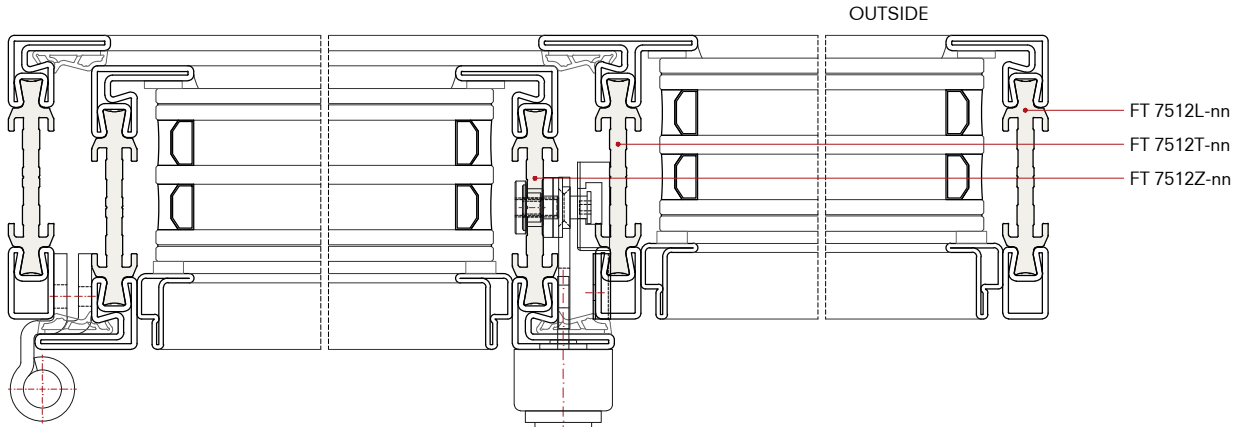

B

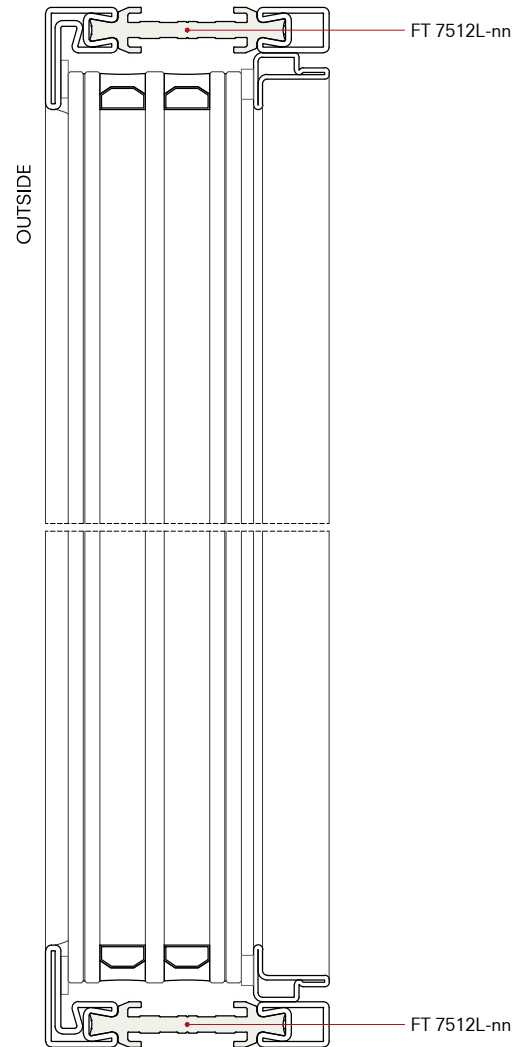

C

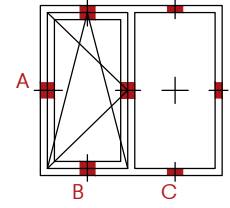

A

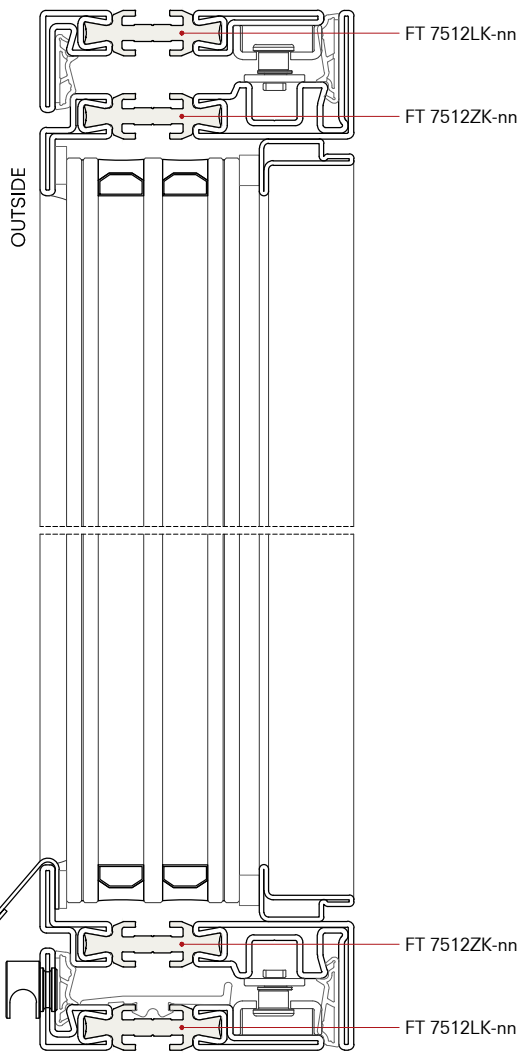
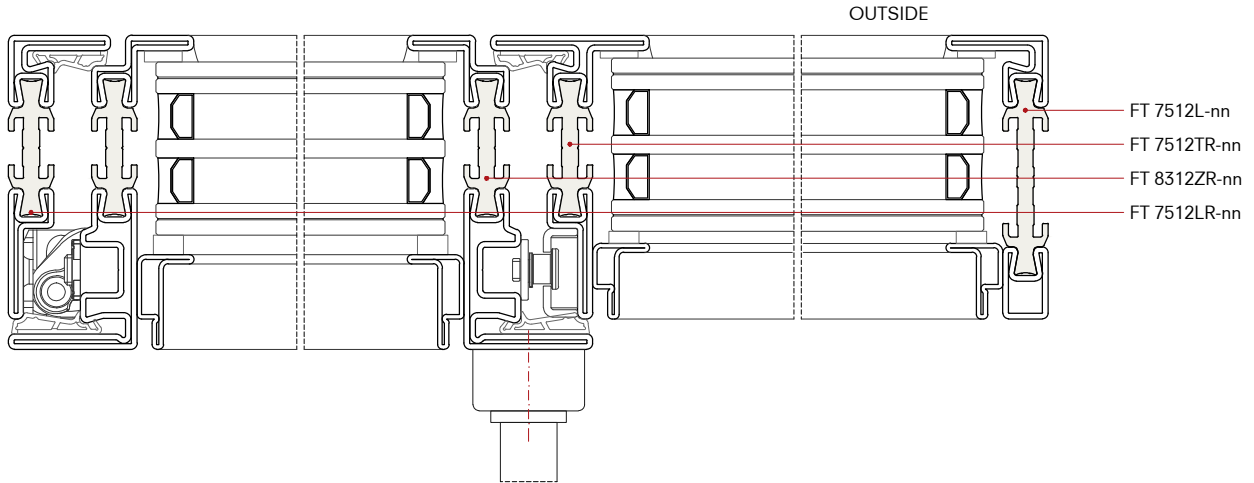

B

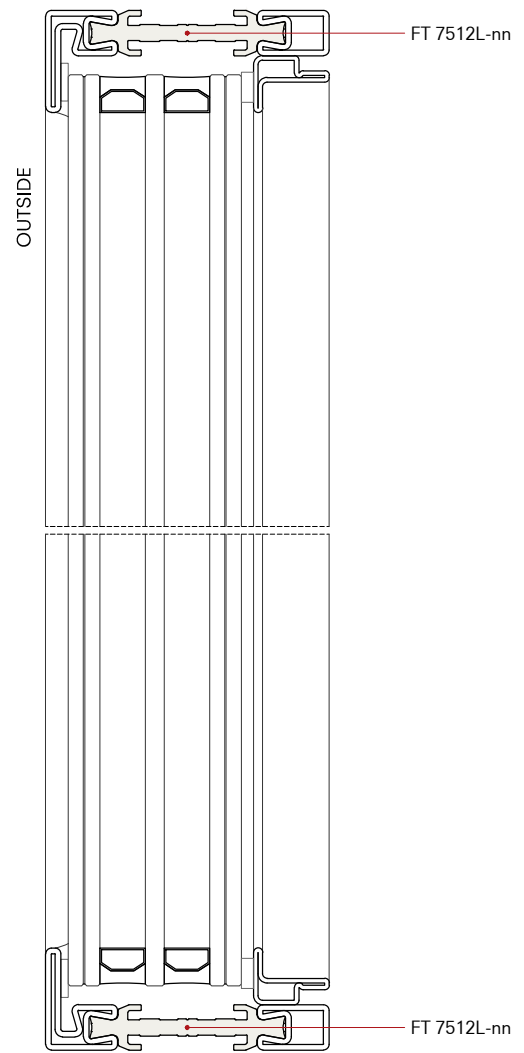

C

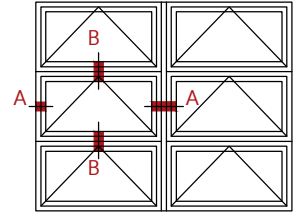

A

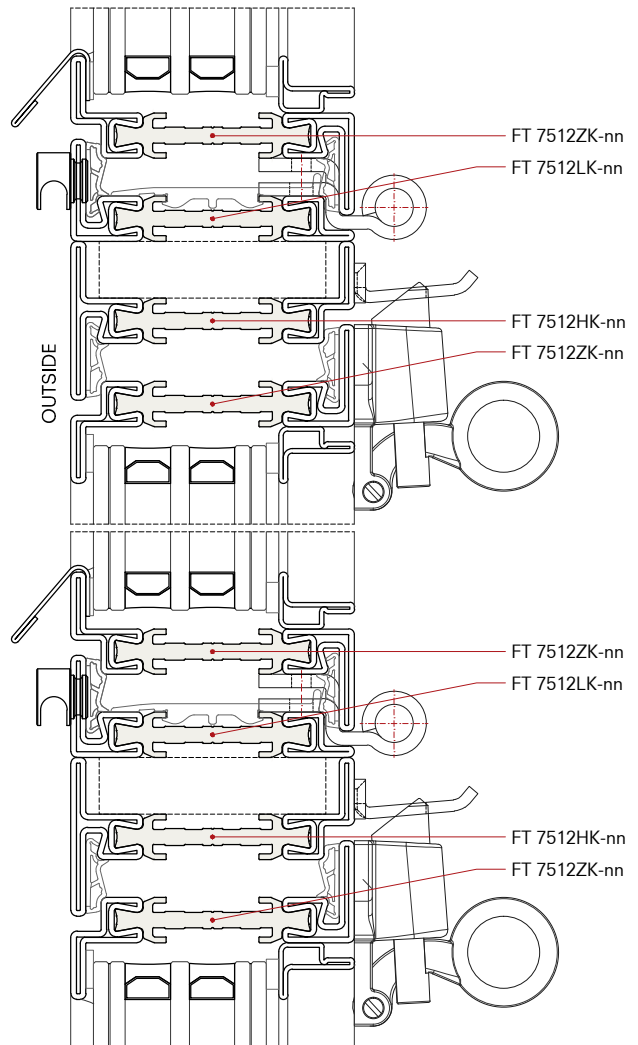
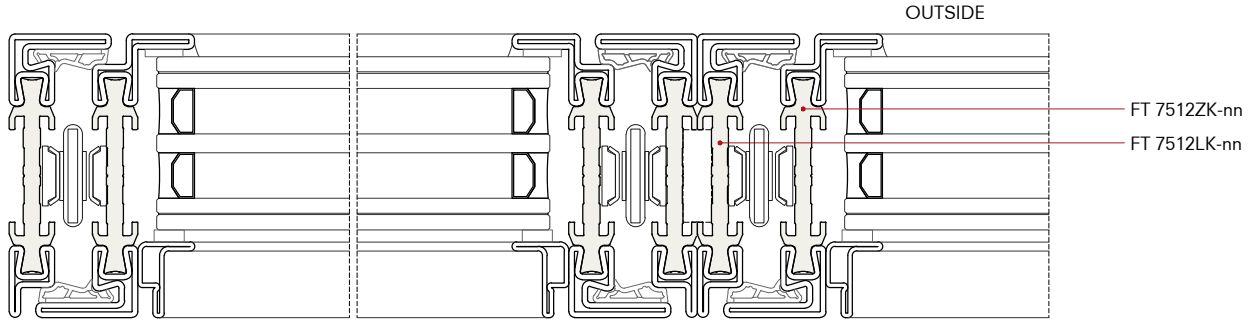

B

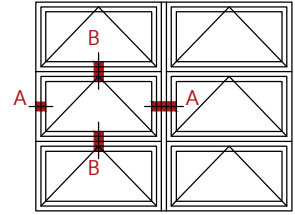

A

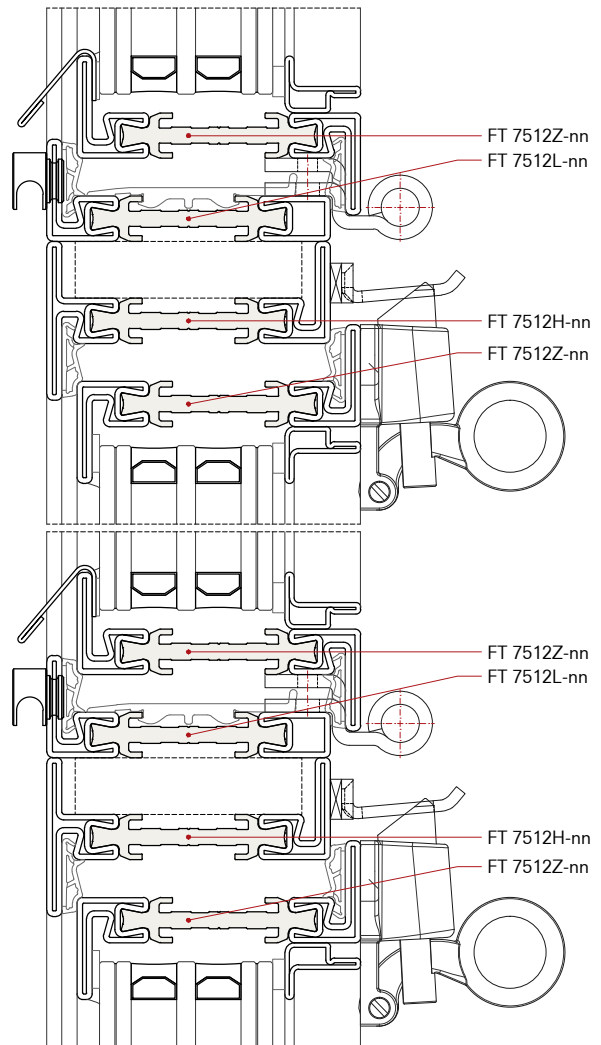
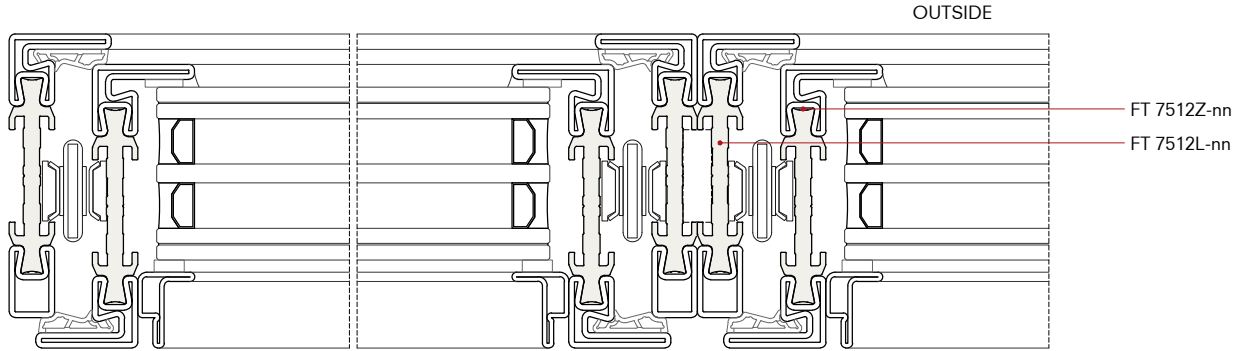

B

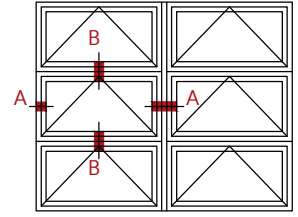

A

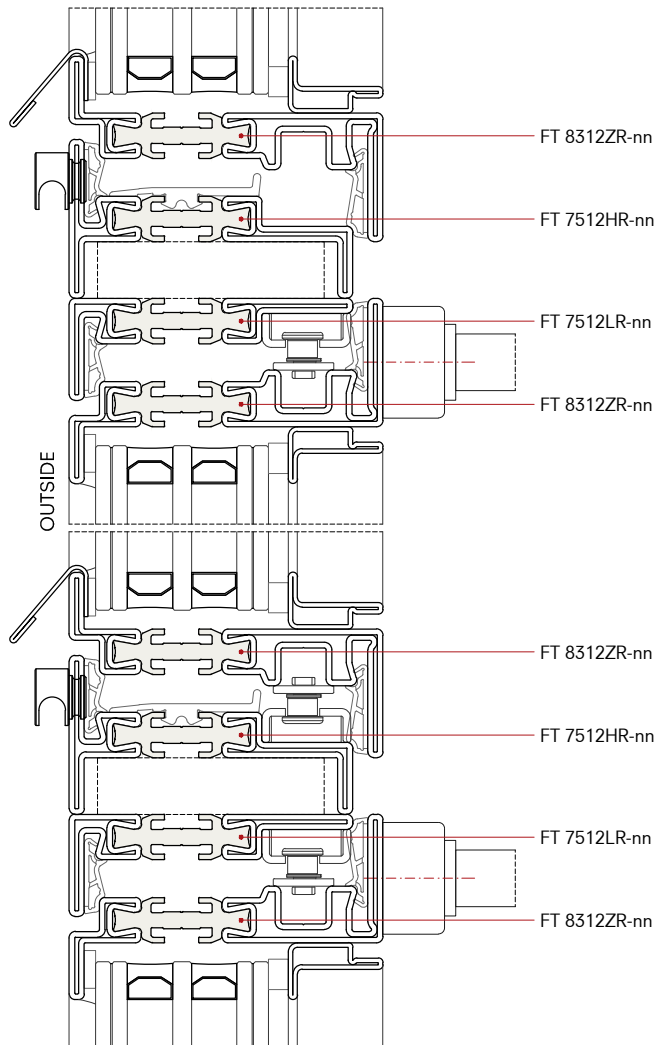
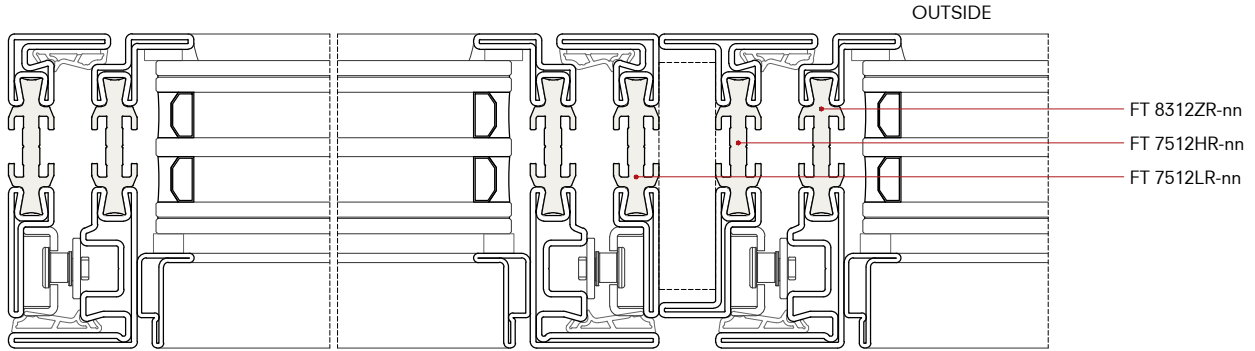

B

A

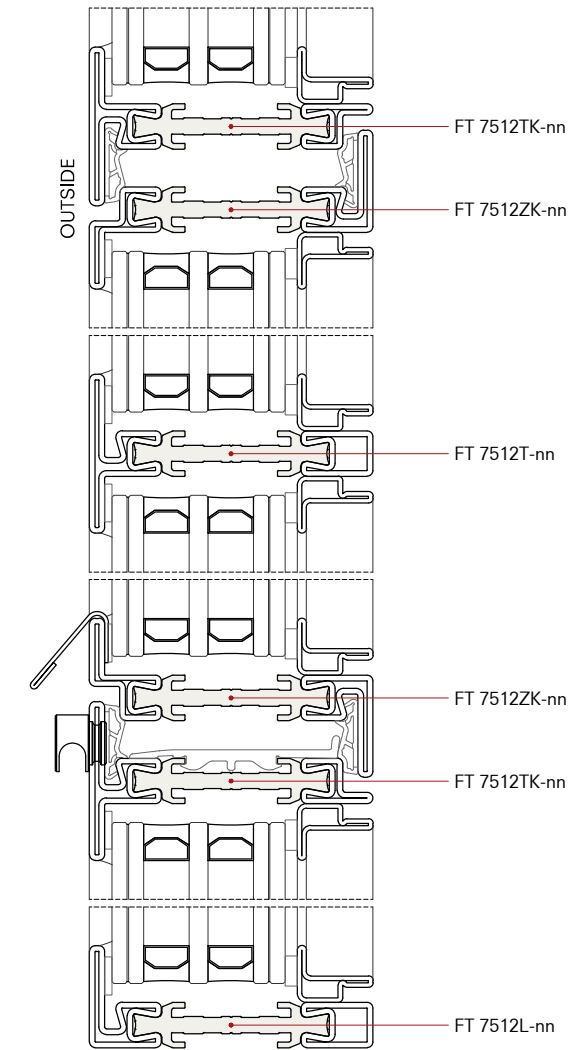
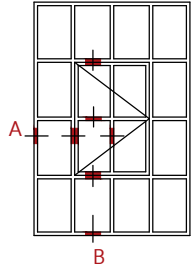
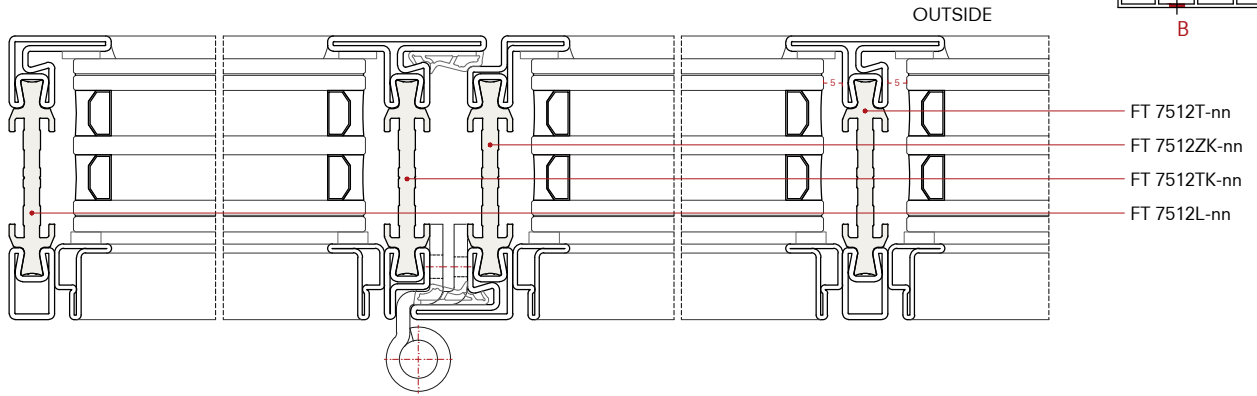

B

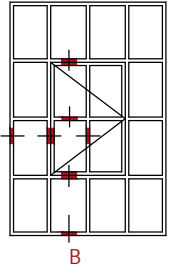

A

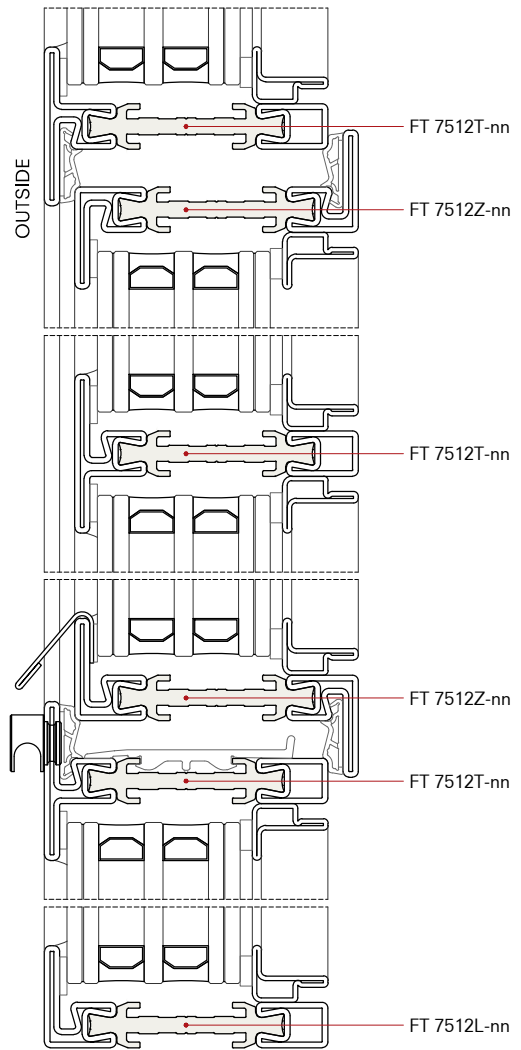
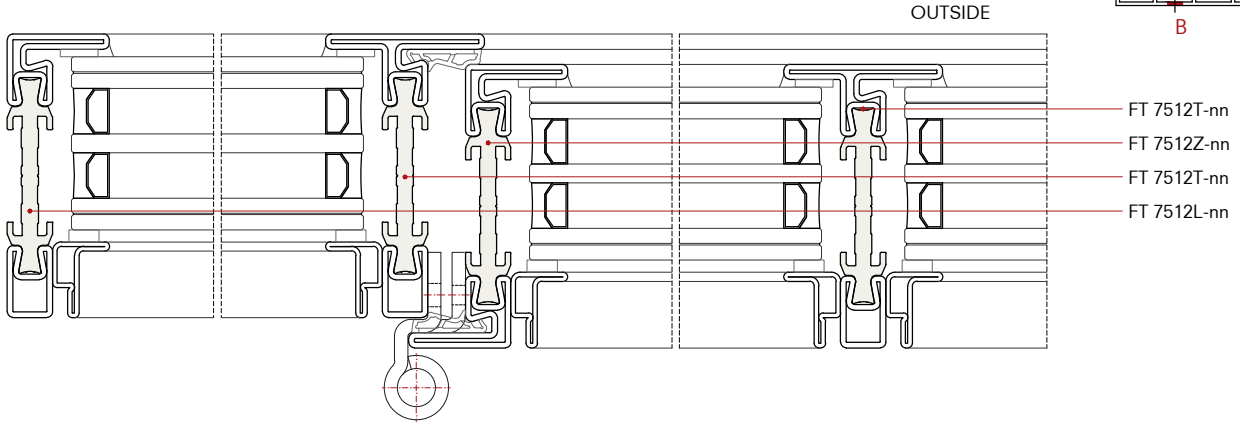

B

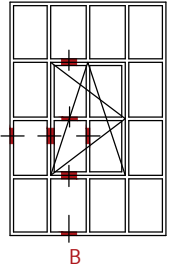

A

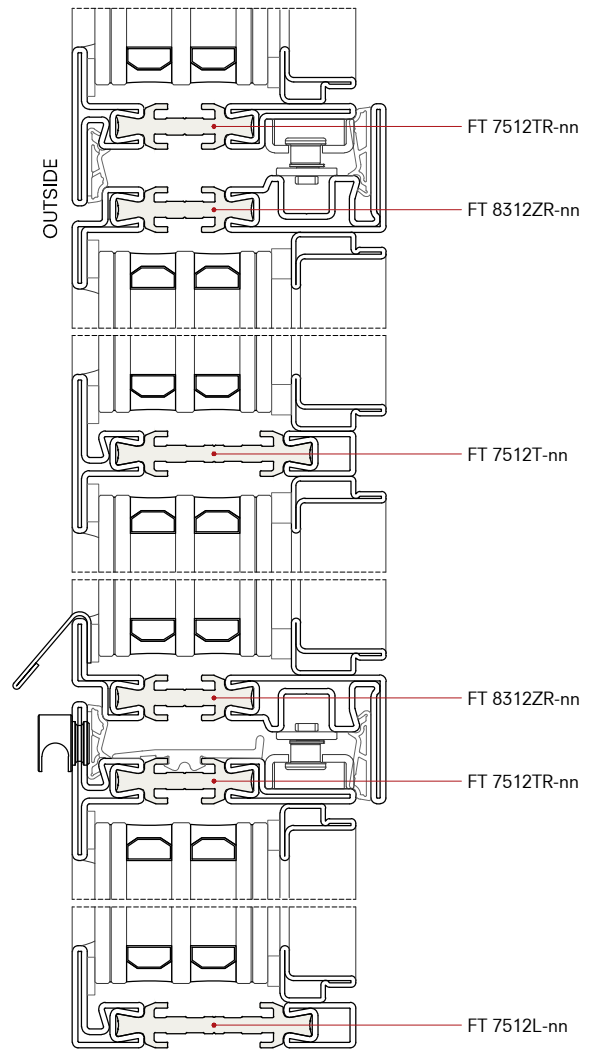
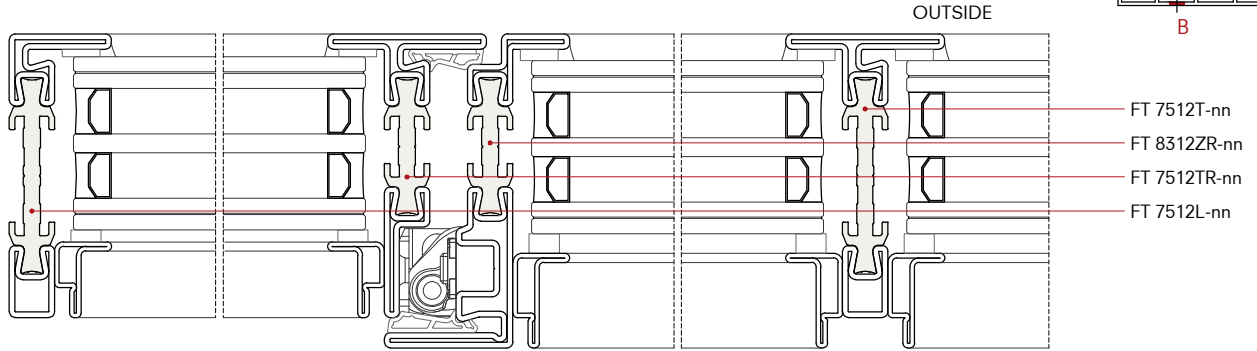

B

A

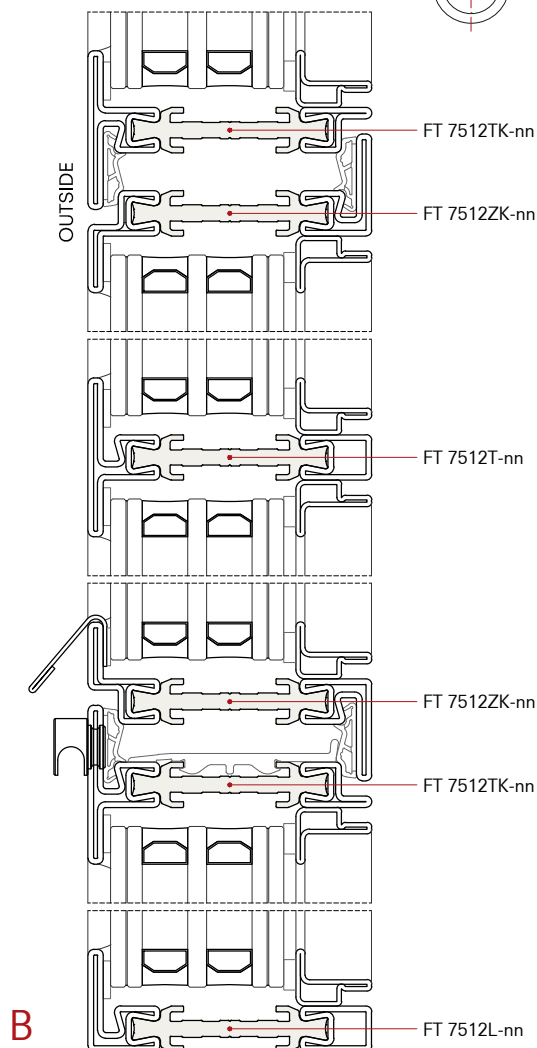
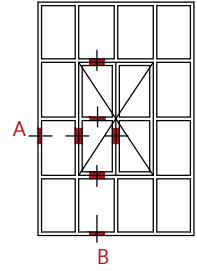
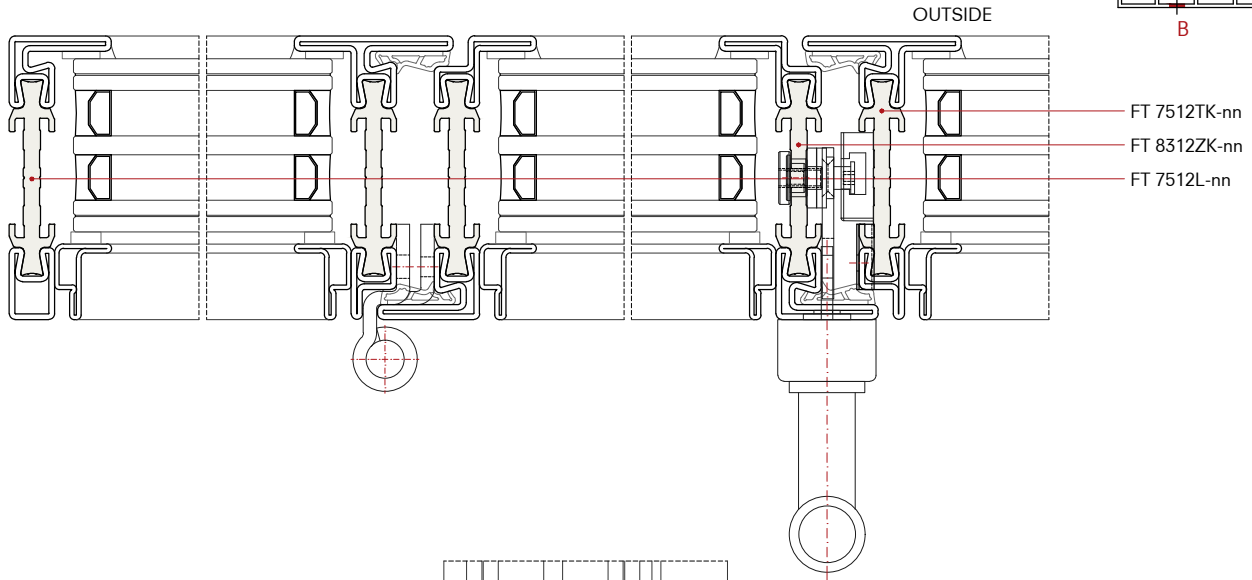

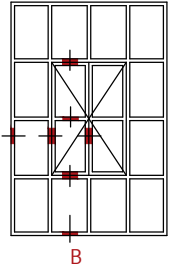

A

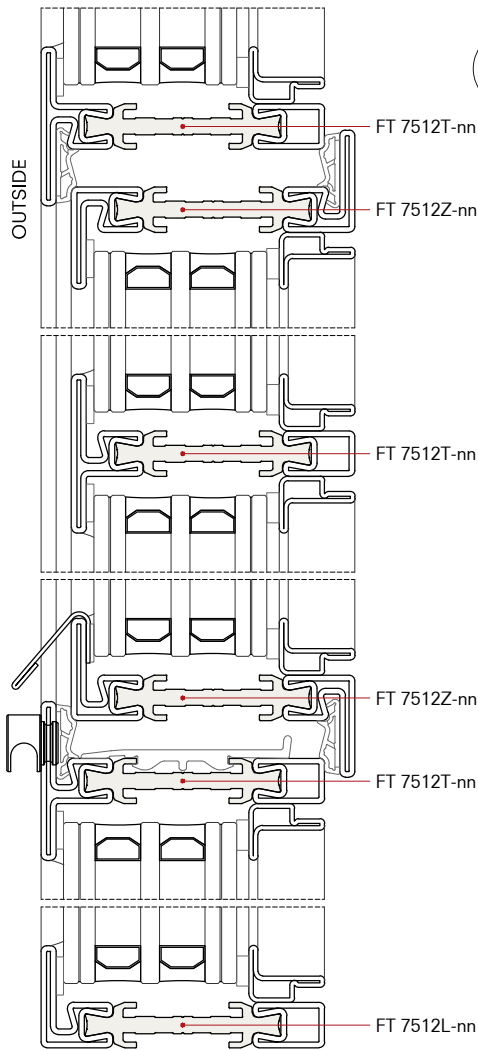
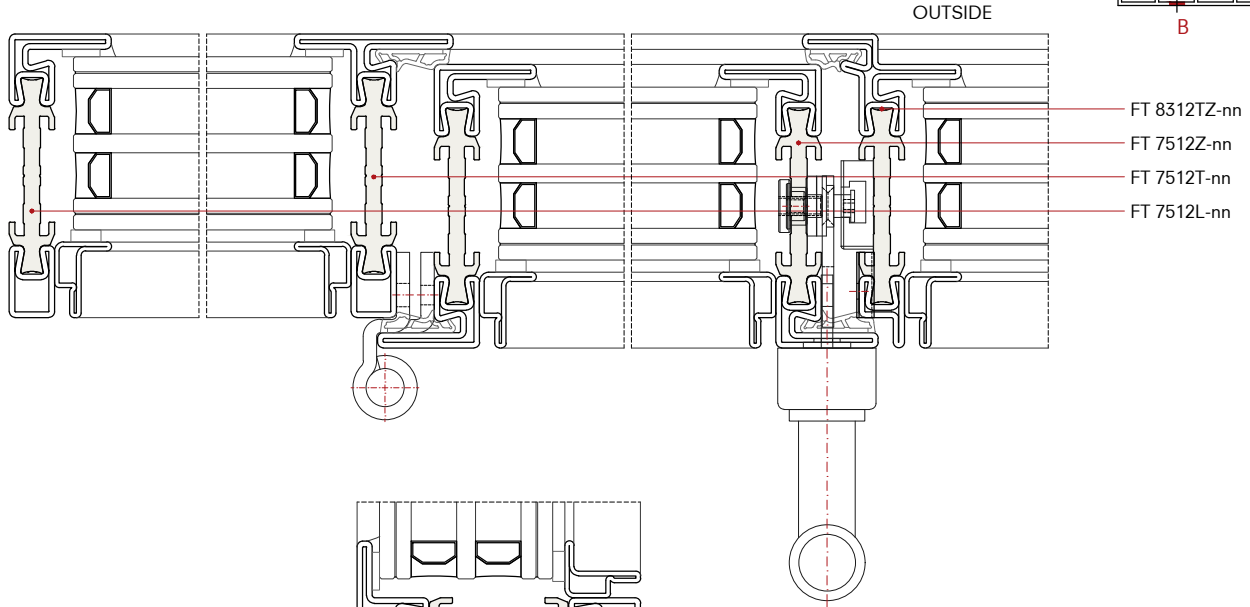

B

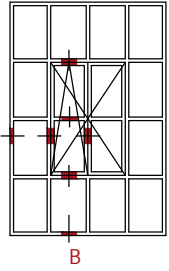

A

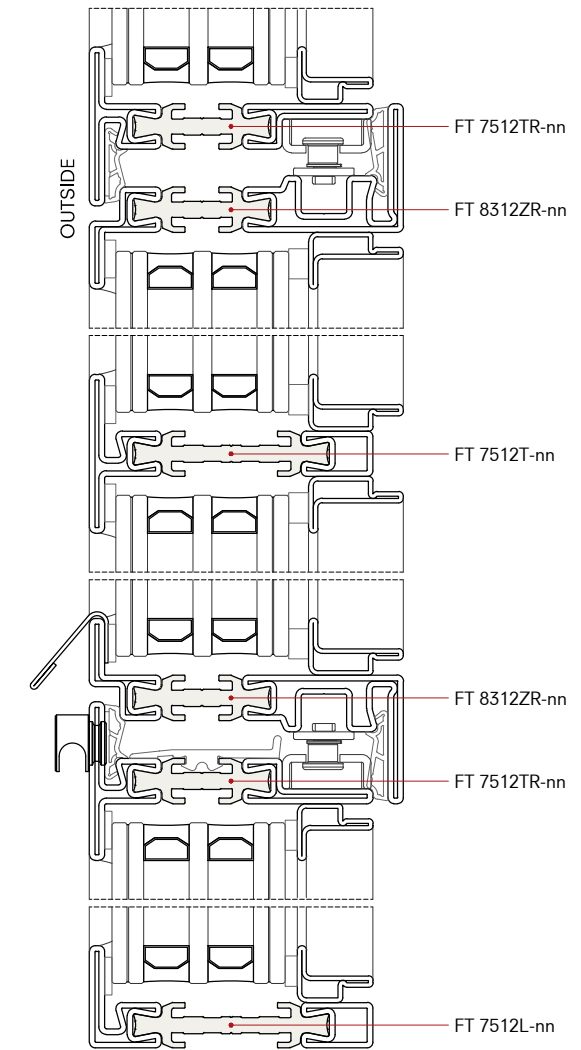
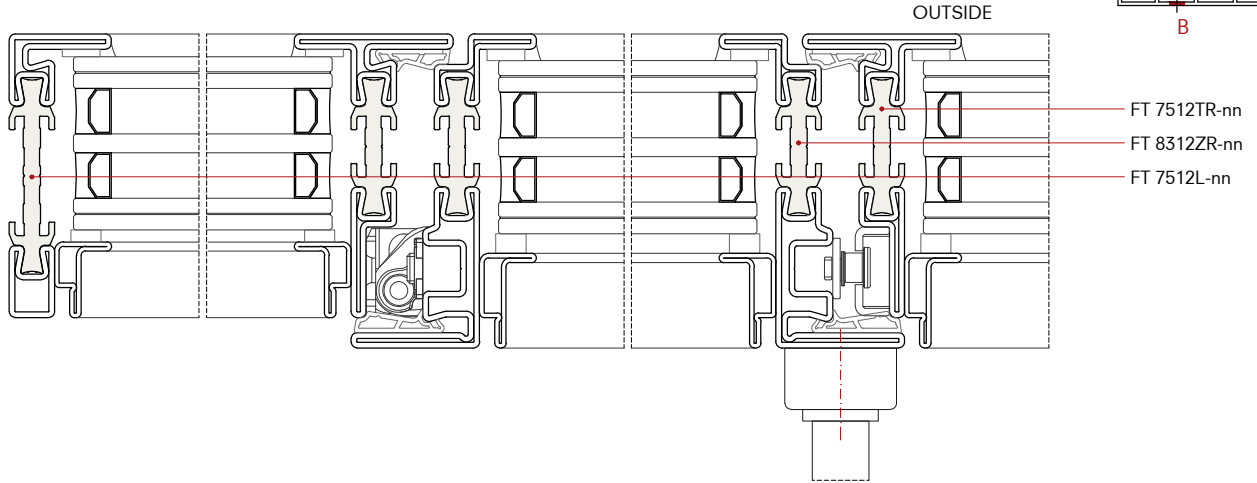

B

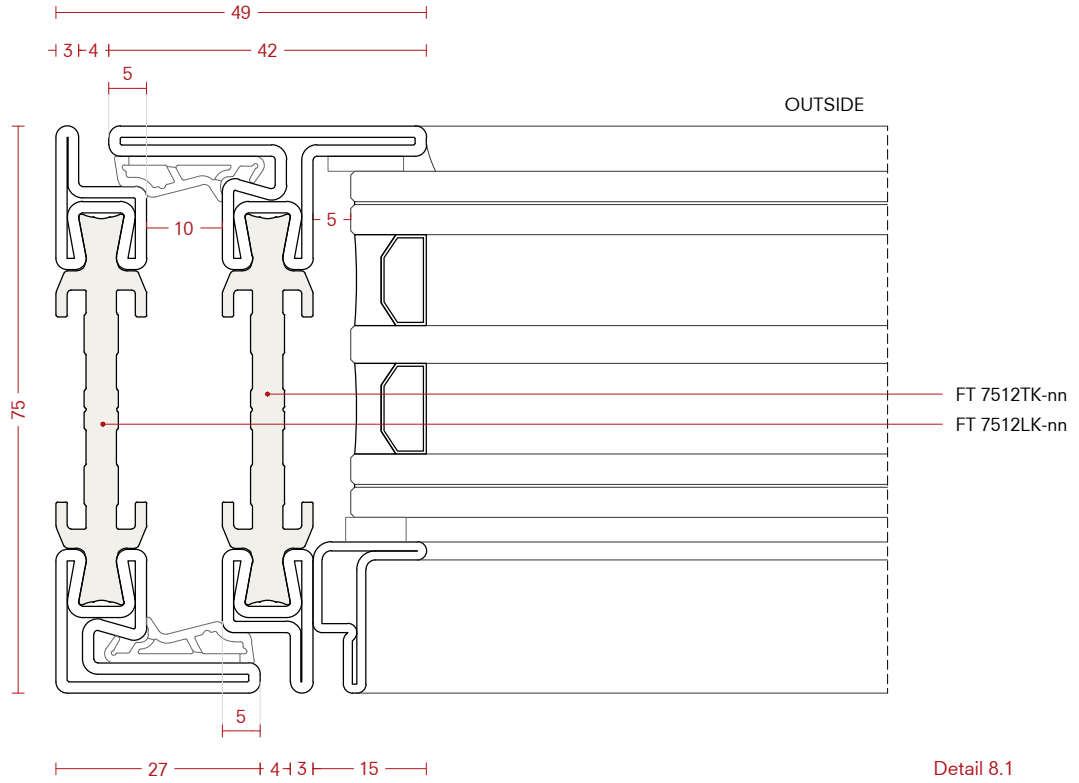
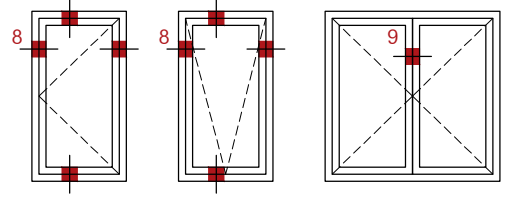

Detail 8.1

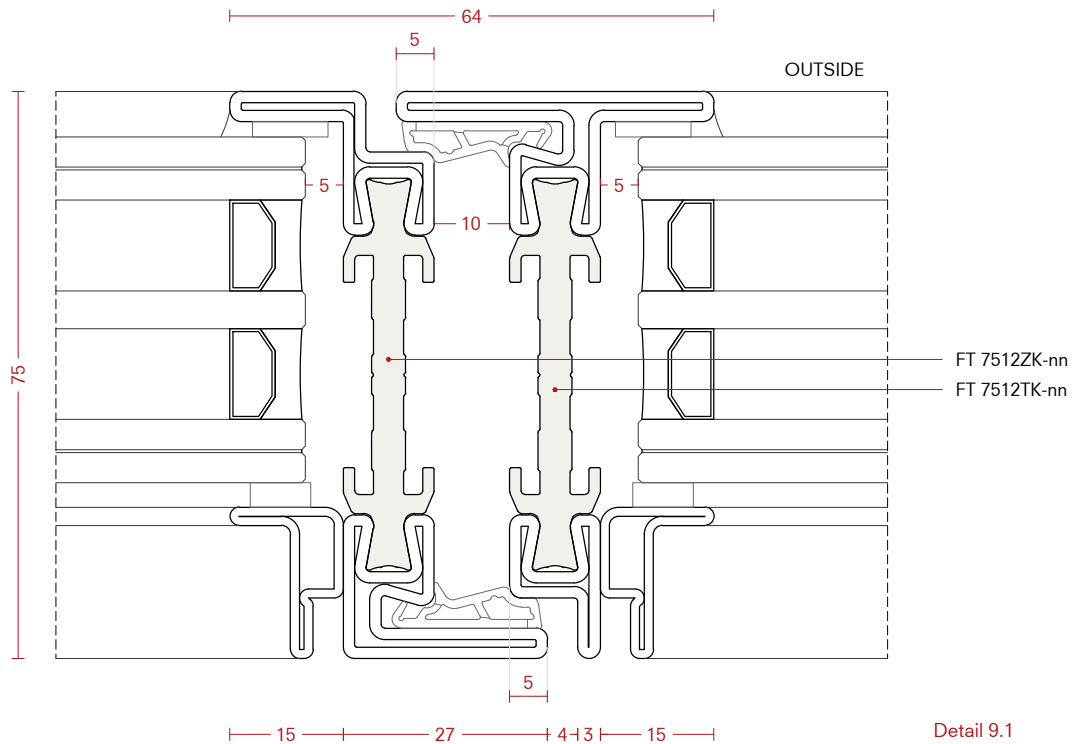

Detail 9.1

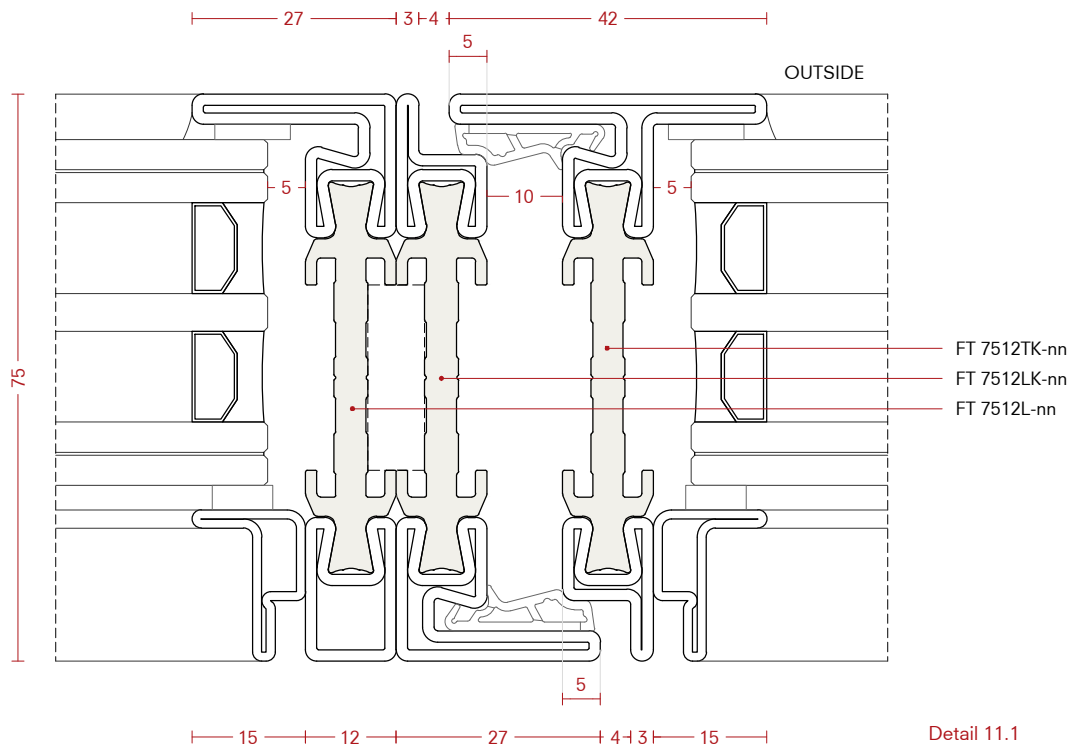
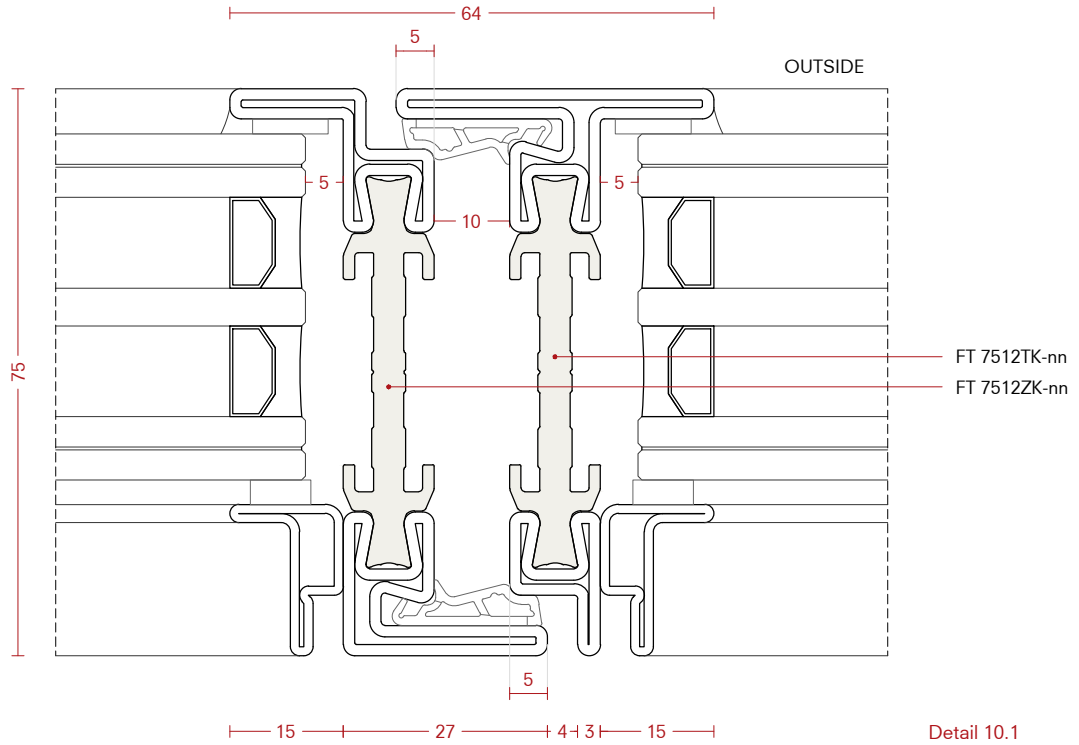
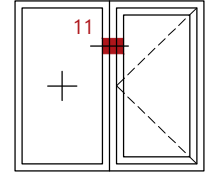
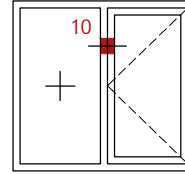

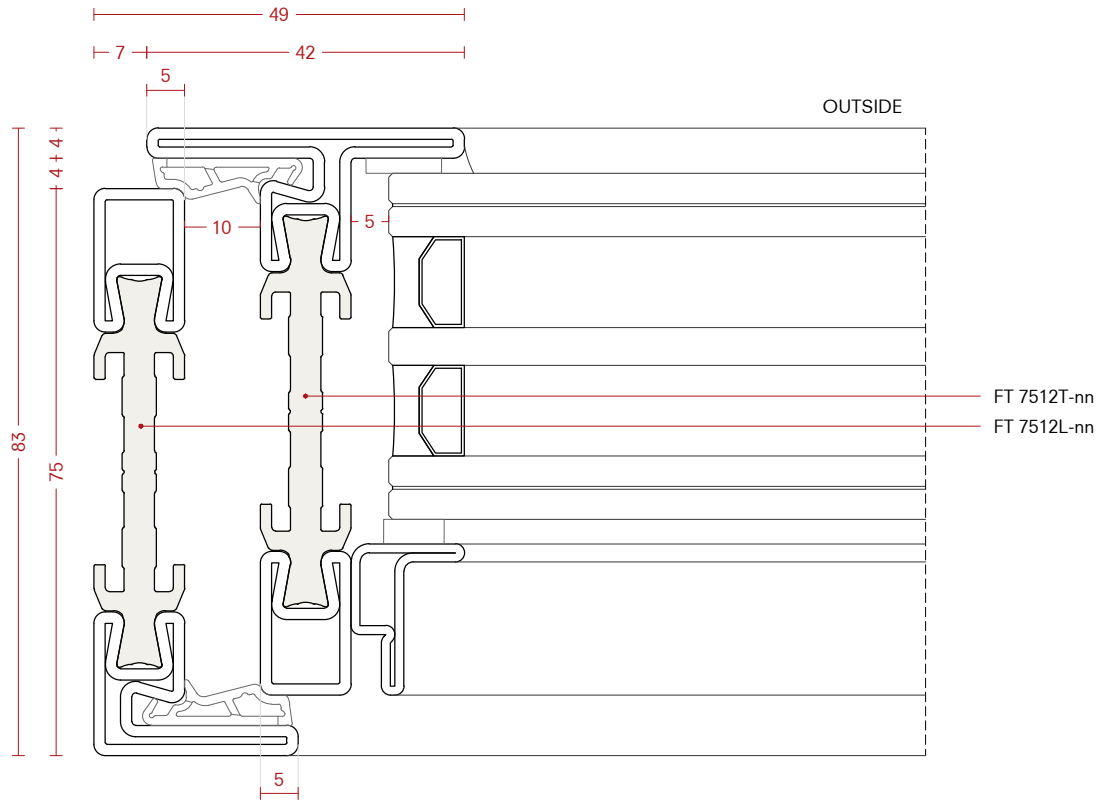
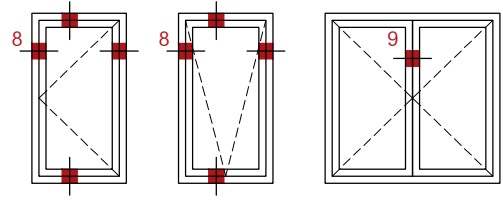

Detail 8.2

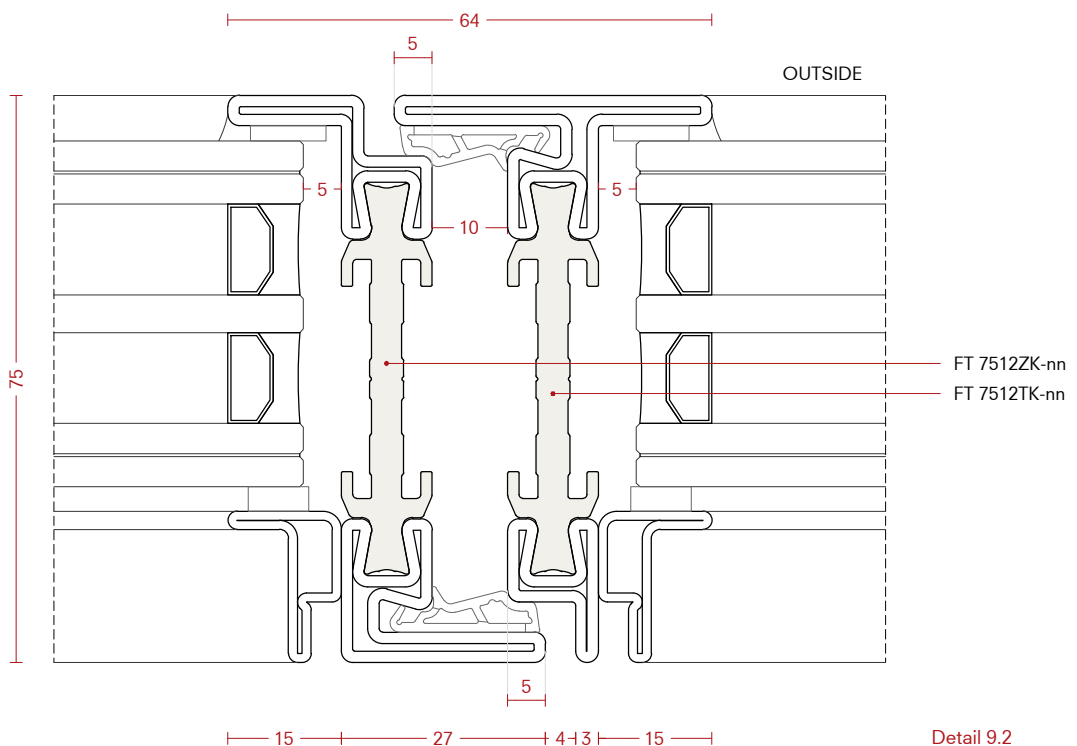

Detail 9.2

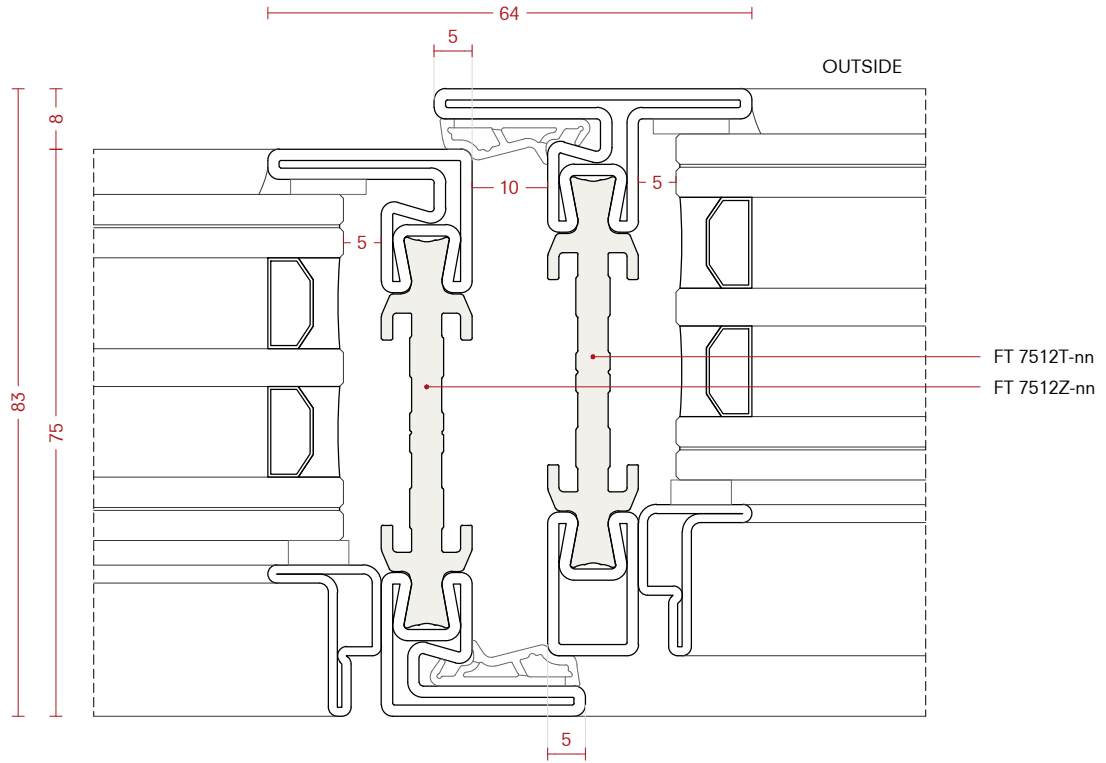
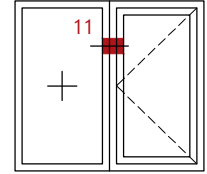
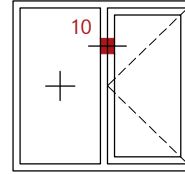

Detail 10.2

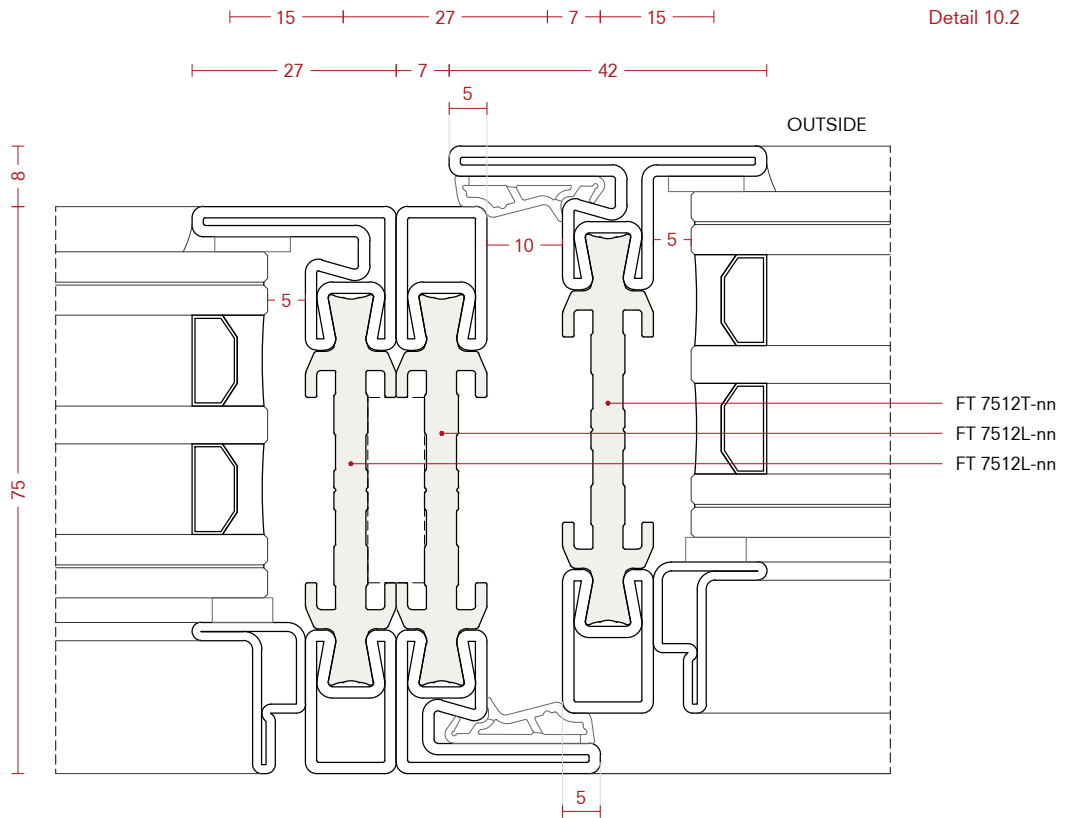

Detail 11.2

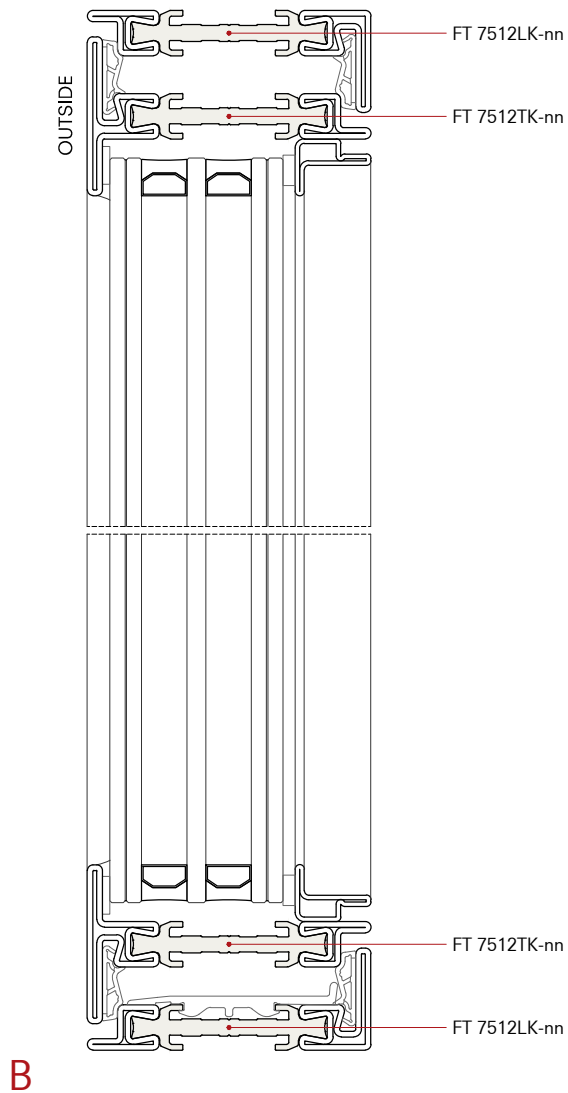
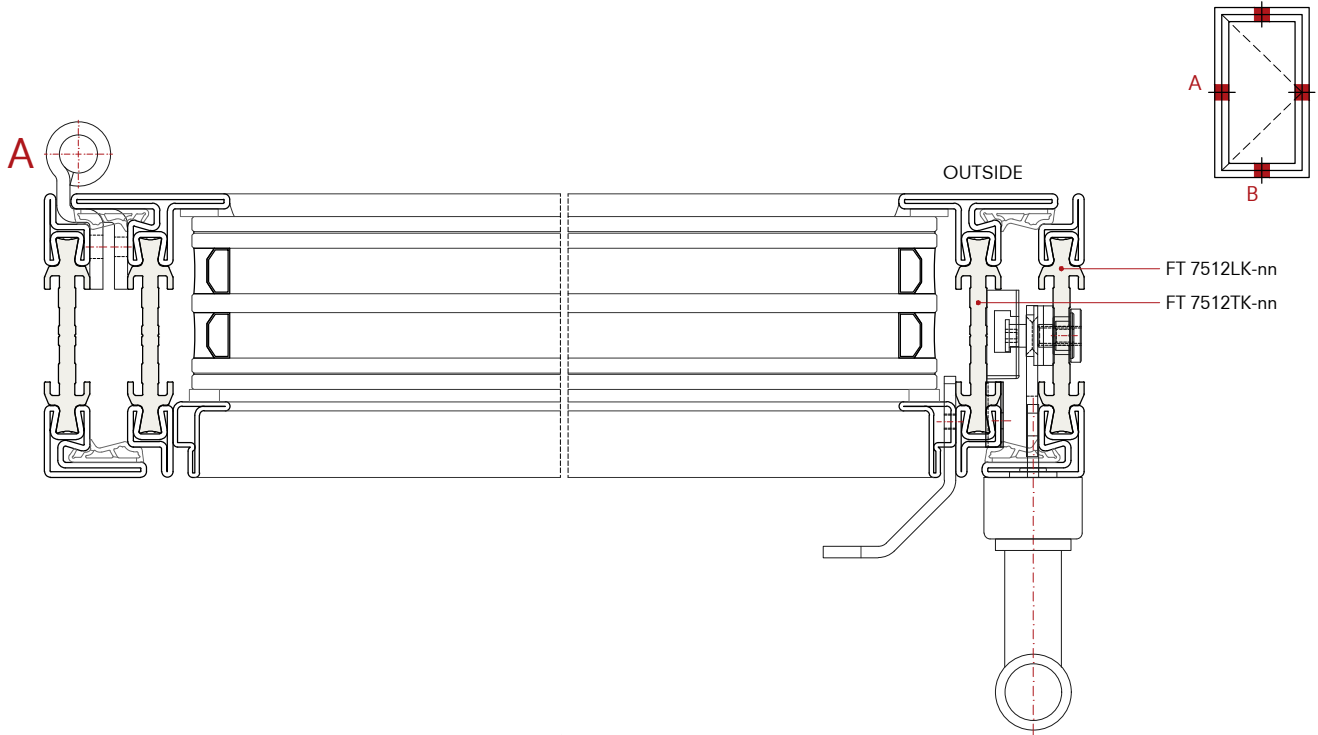

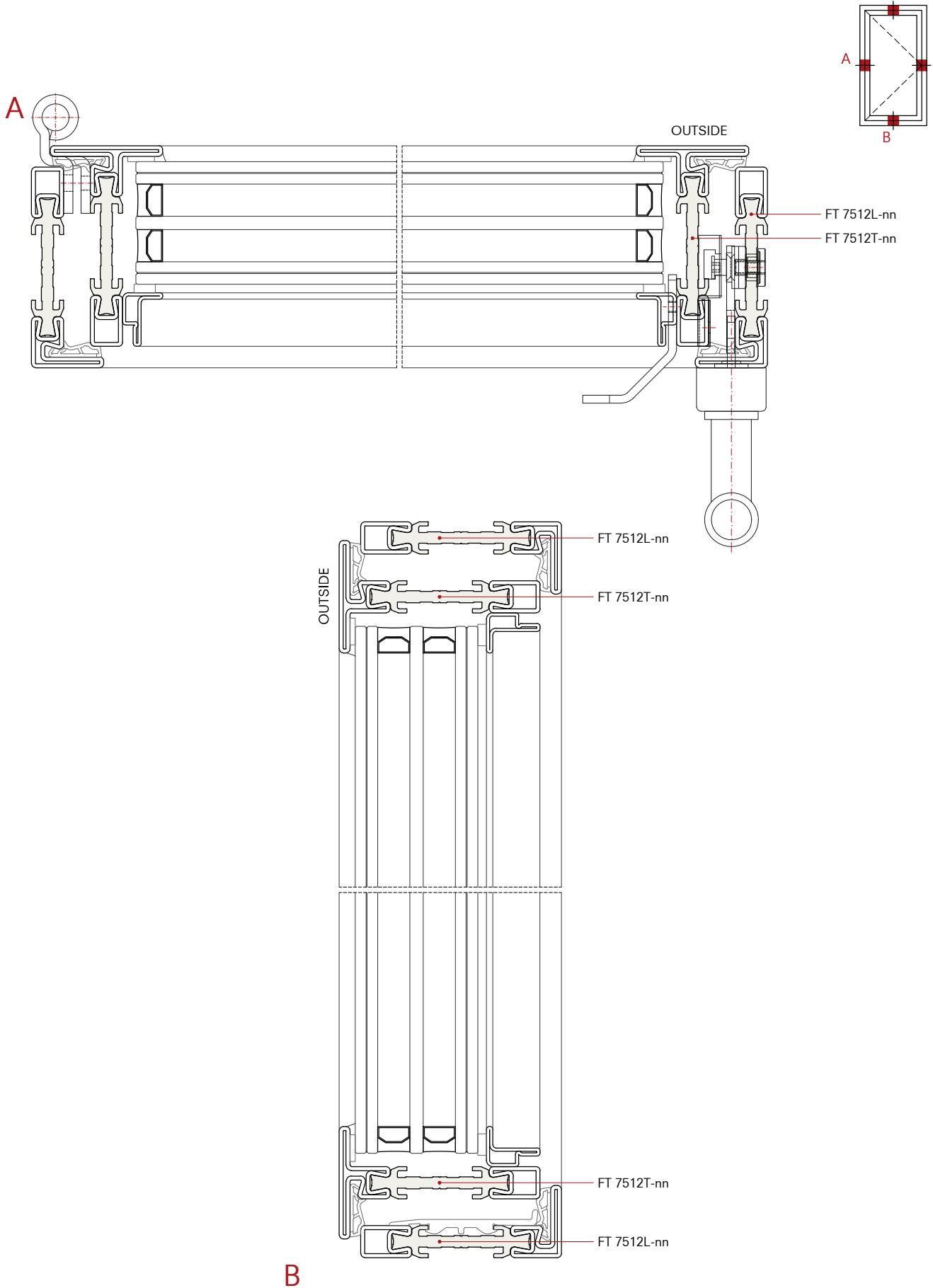

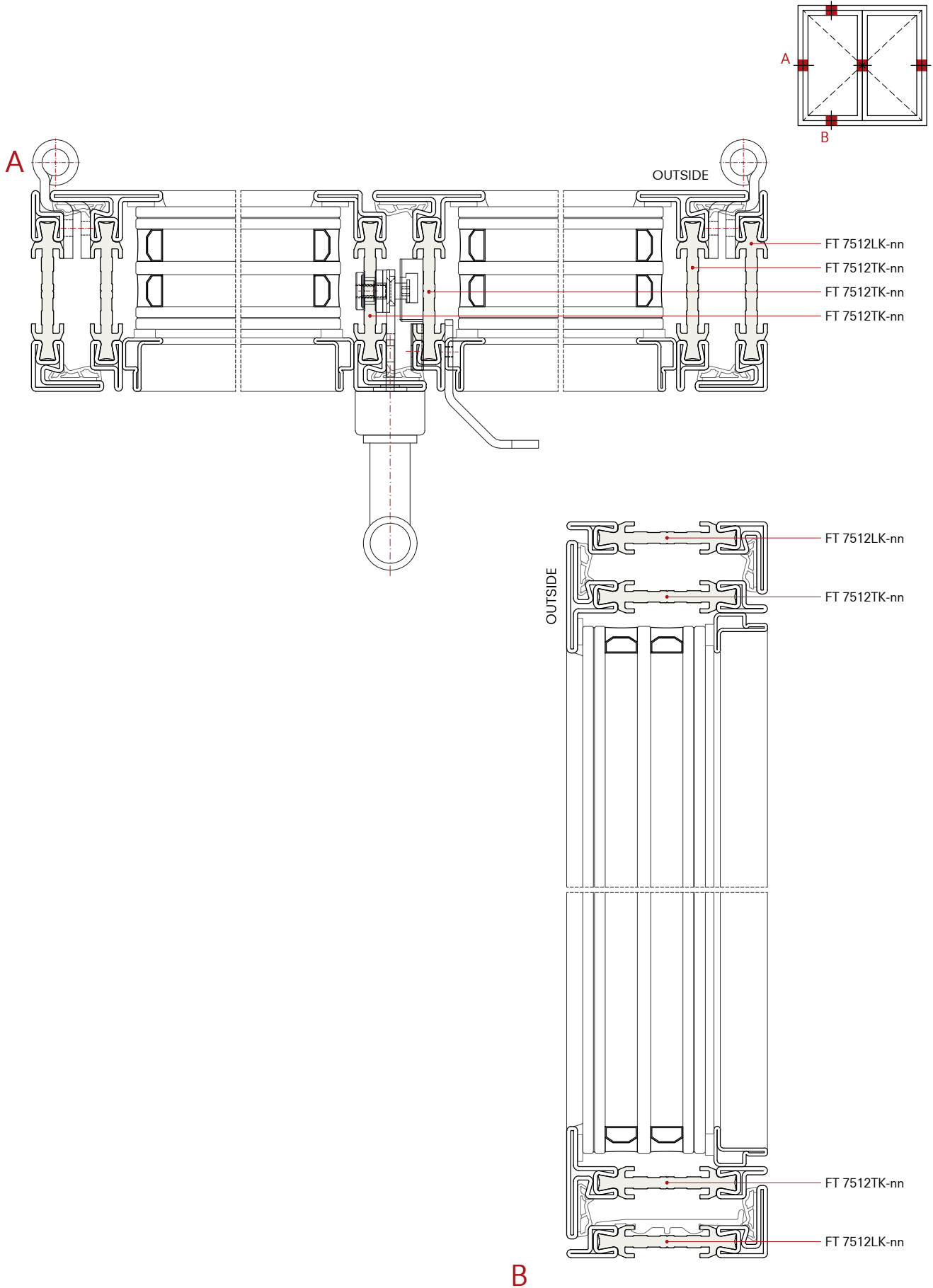

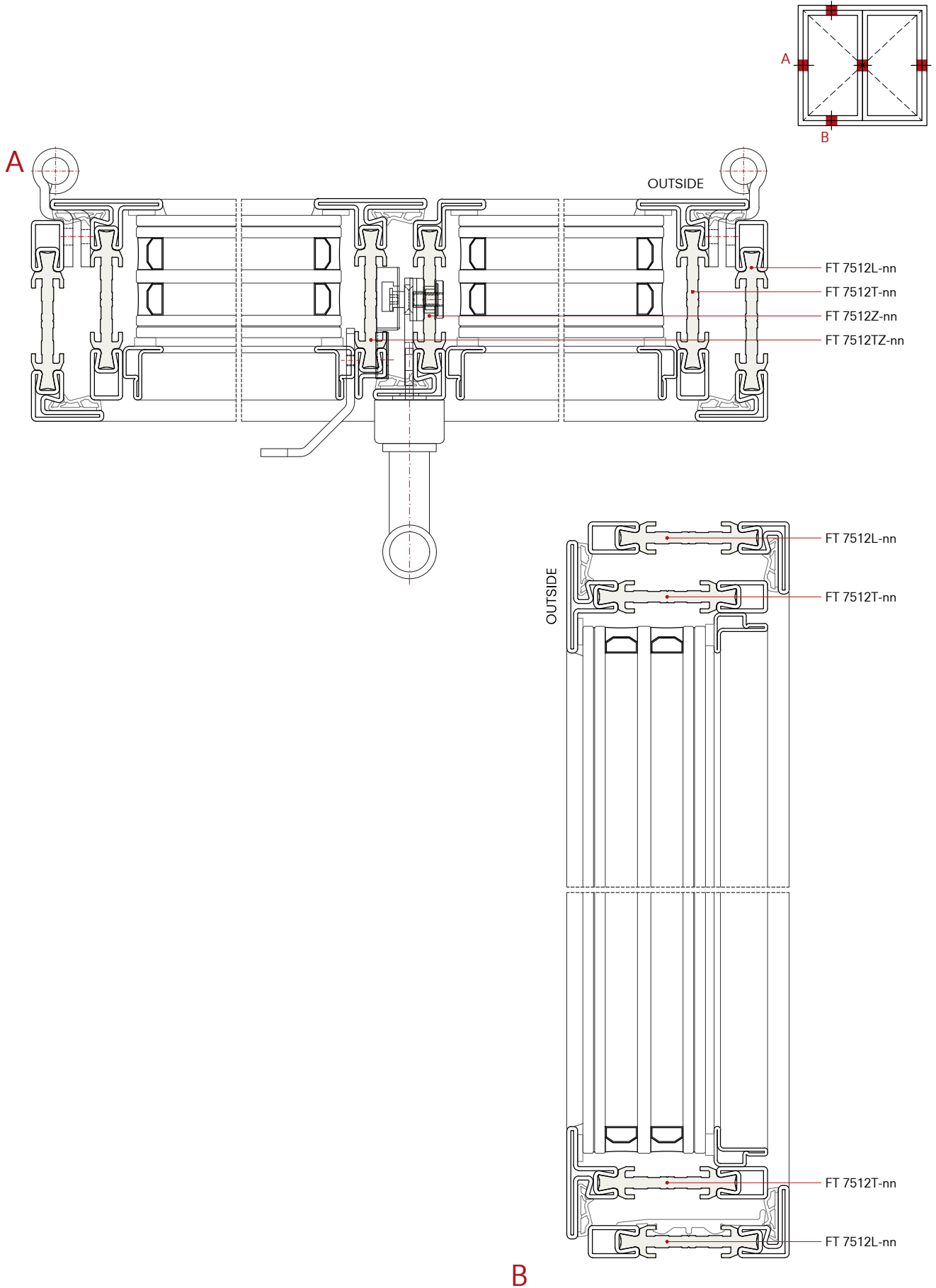

A

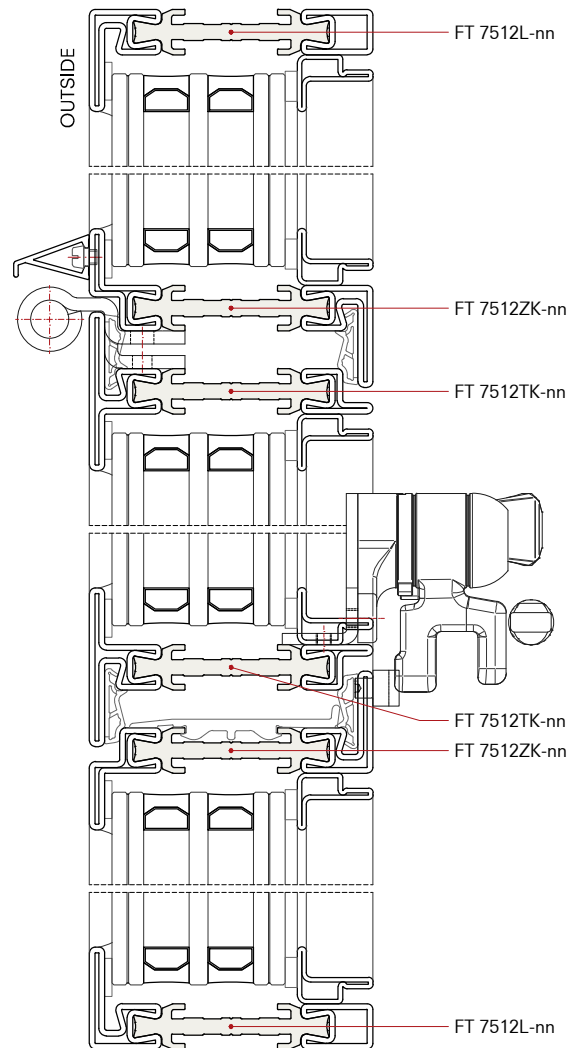
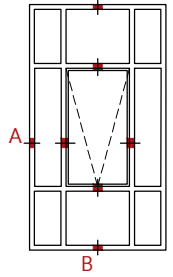
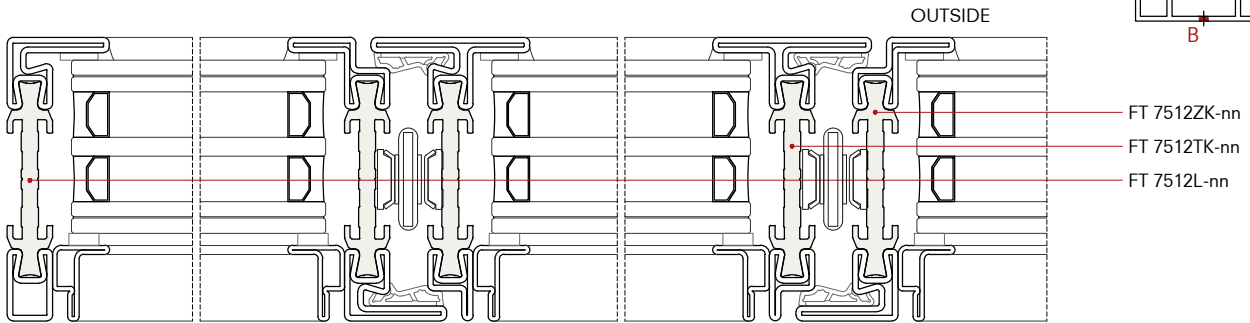

B

A

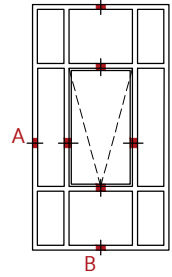
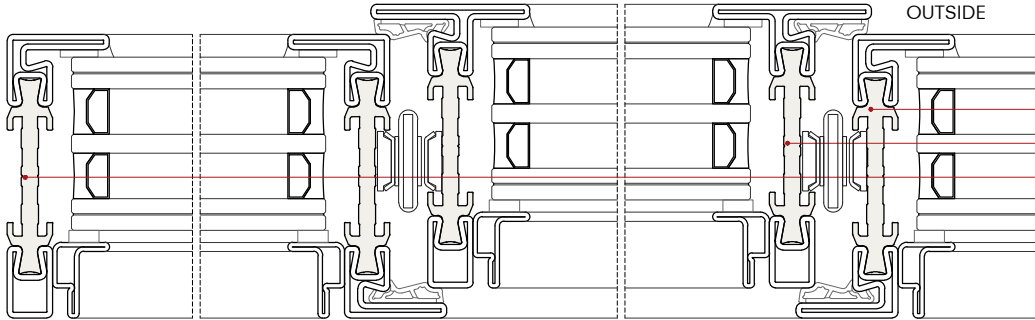

- FT 7512Z-nn
- FT 7512T-nn
- FT 7512L-nn

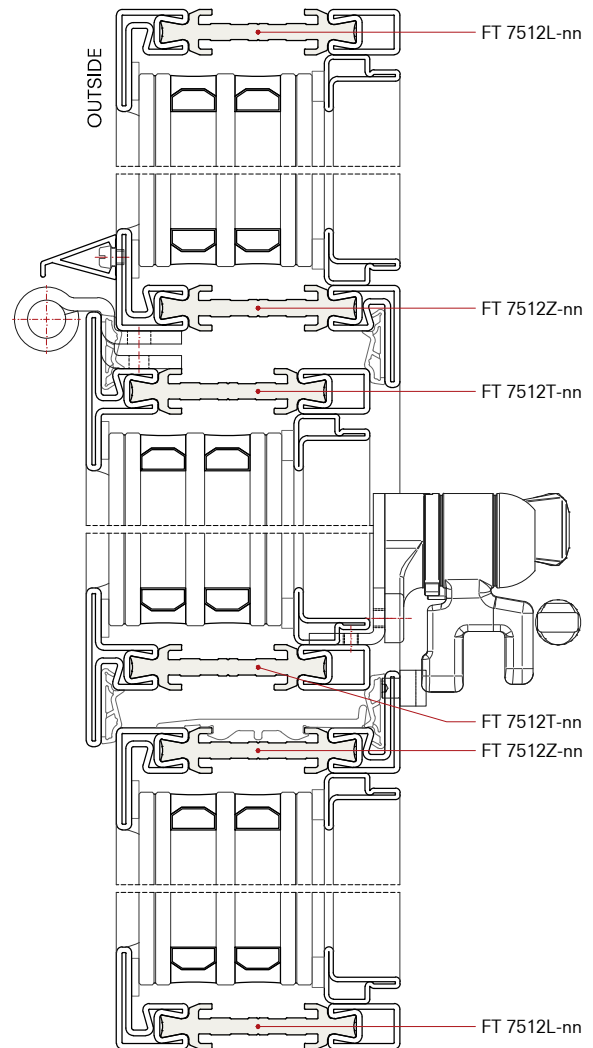

- FT 7512L-nn
- FT 7512Z-nn
- FT 7512T-nn
- FT 7512T-nn
- FT 7512Z-nn
- FT 7512Z-nn
- FT 7512L-nn

B

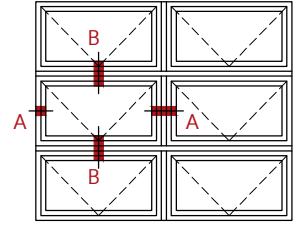

A

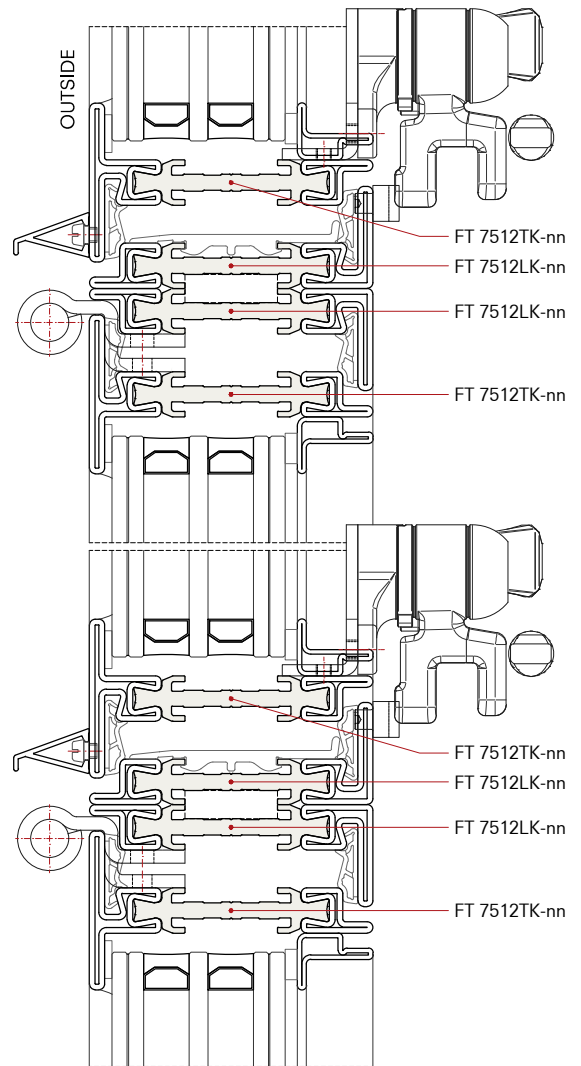
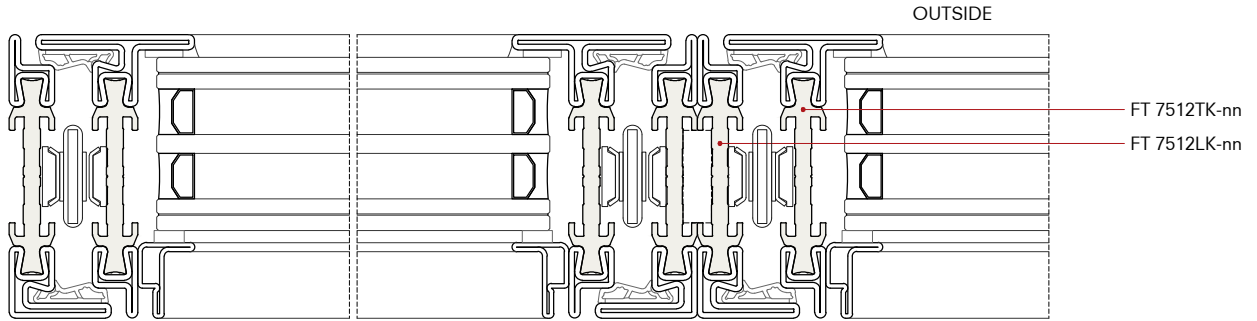

B

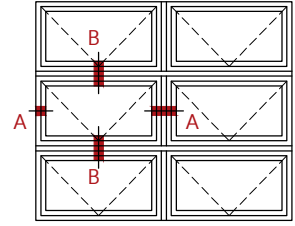

A

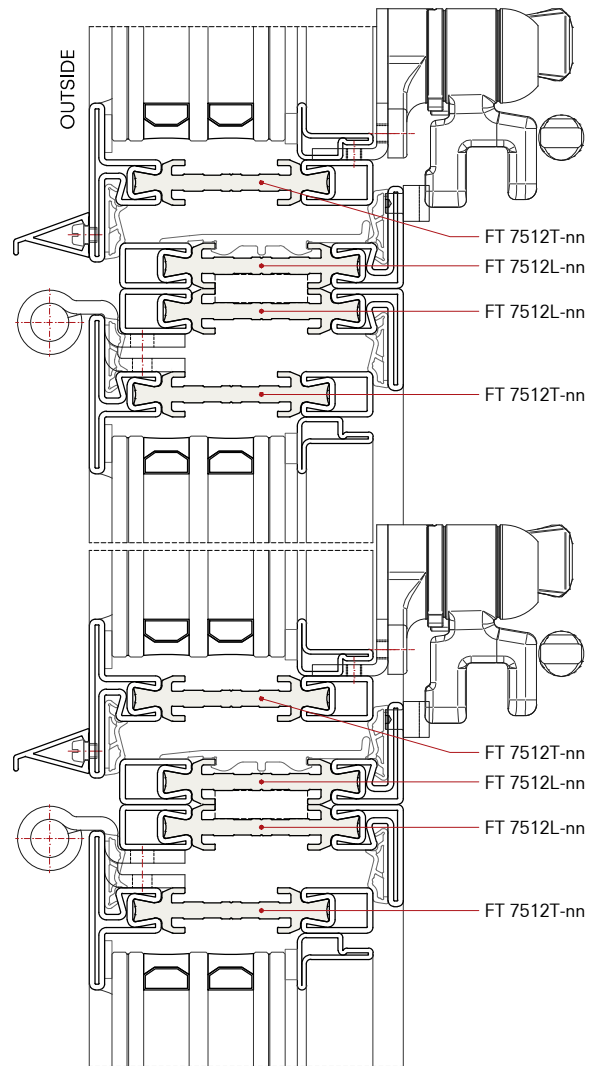
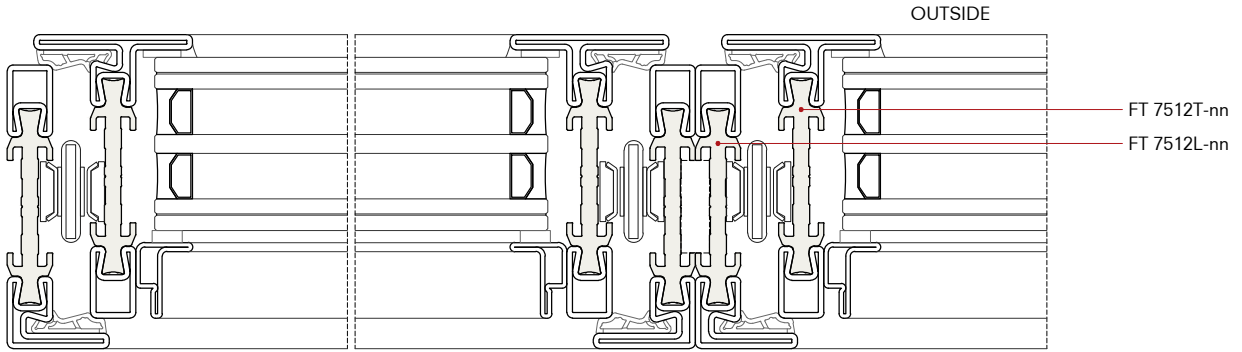

B

Profile matching

Kombination von Profile

Combinaison de profils

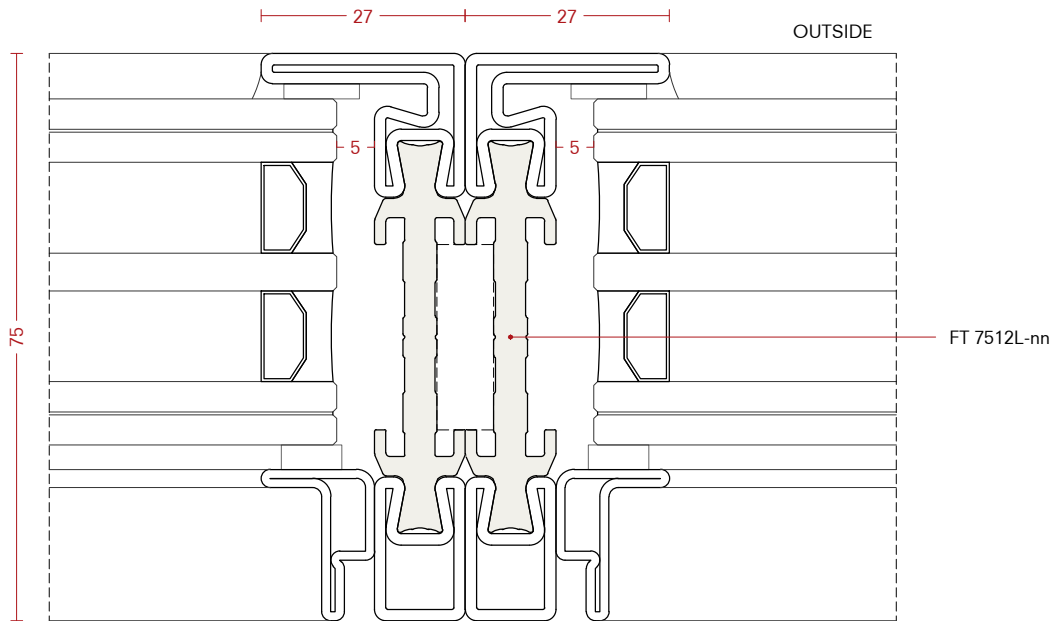
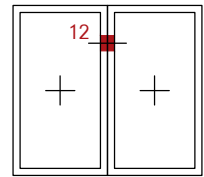

Detail 12.1

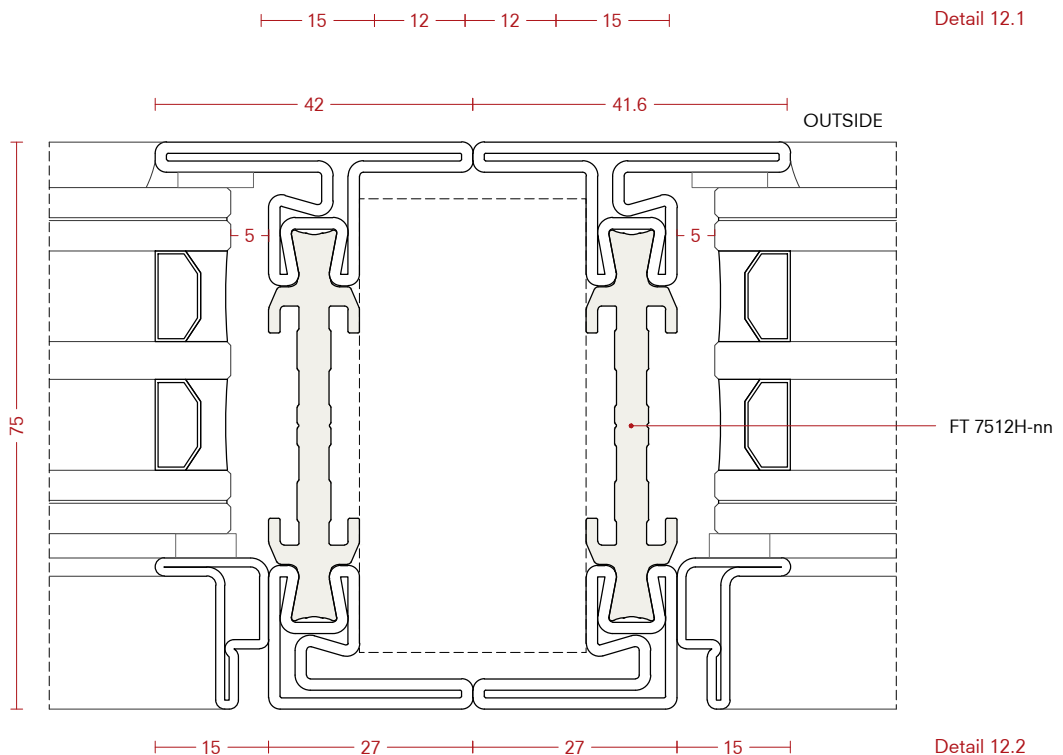

Detail 12.2

Note:

For the cutting list, consider the appropriate machining and welding tolerances in relation to the laying areas and the sealing chosen.

Anmerkung:

Berücksichtigen Sie für die Schnittliste die geeigneten Bearbeitungs- und Schweißtoleranzen in Bezug auf die Verlegebereiche und die ausgewählten Dichtungen.

Remarque:

Pour la liste de coupe, tenez compte des tolérances d'usinage et de soudage appropriées en fonction des zones de pose et des joints choisis.

Profile matching

Kombination von Profile

Combinaison de profils

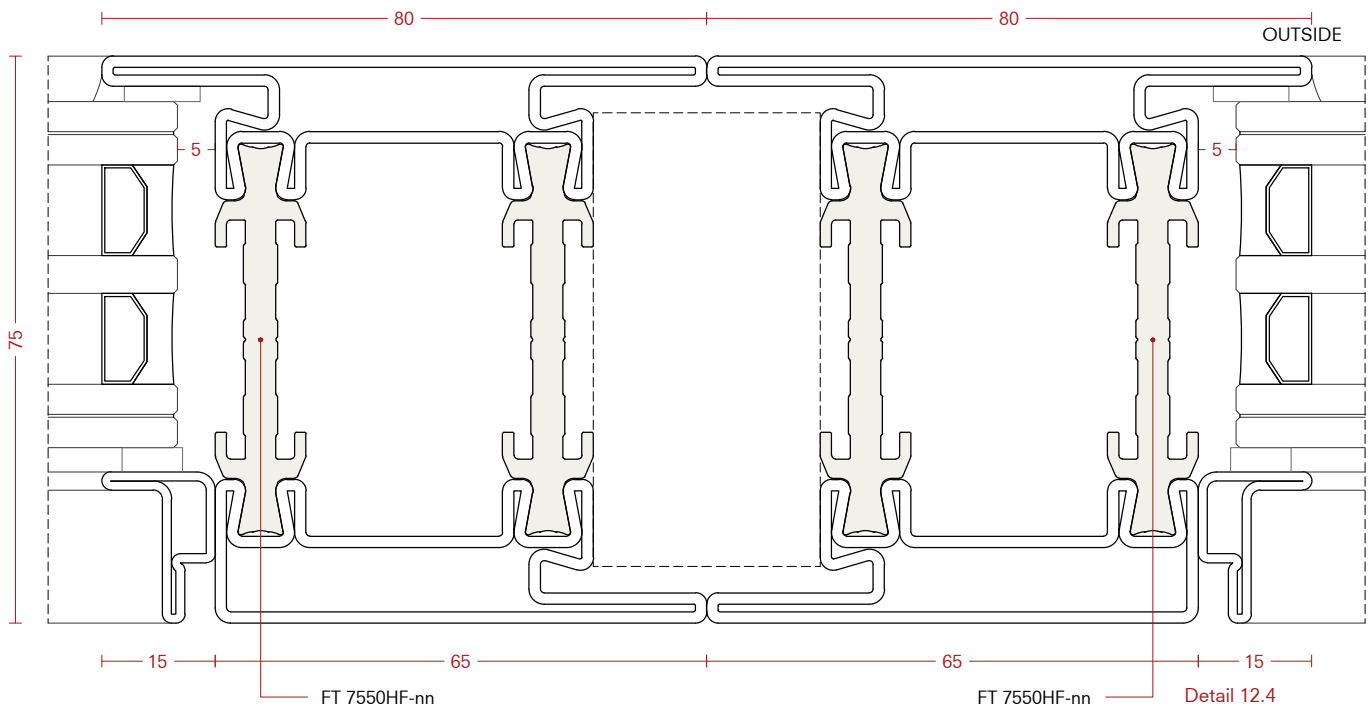
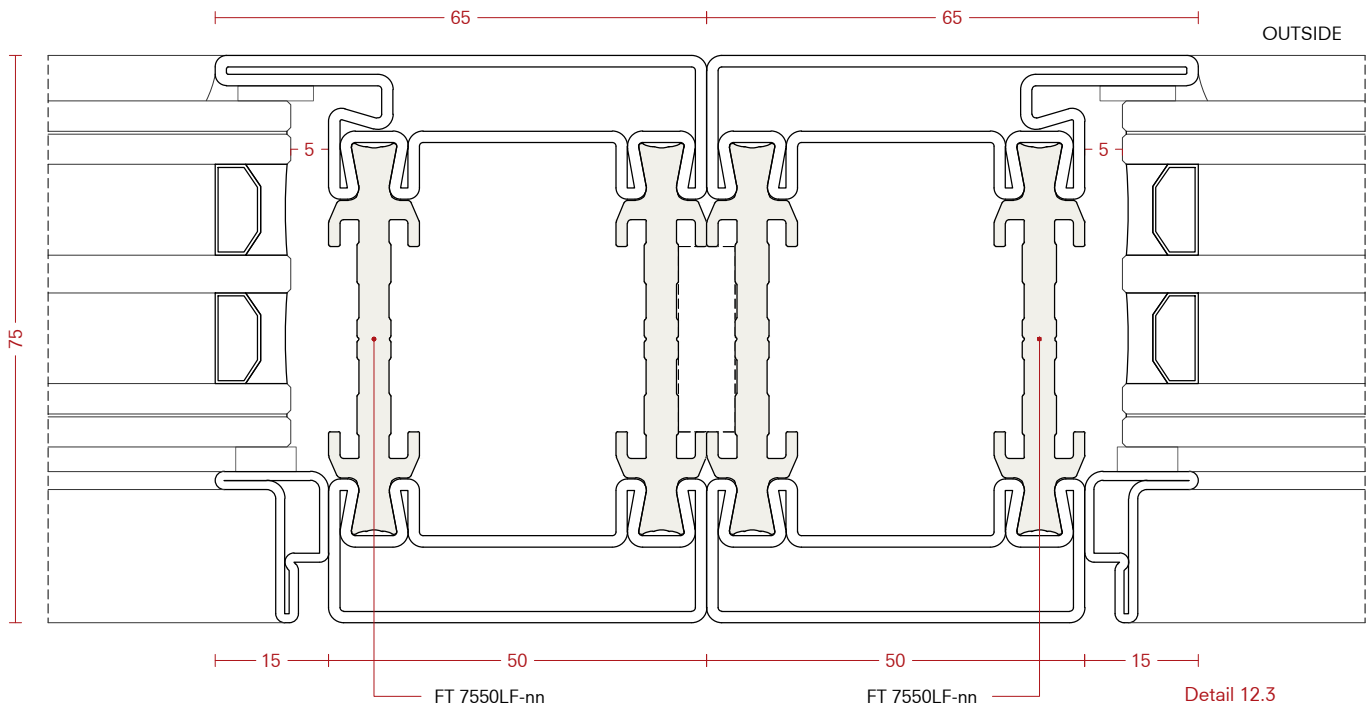
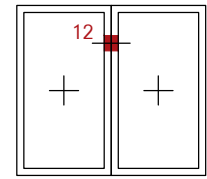

Note:

For the cutting list, consider the appropriate machining and welding tolerances in relation to the laying areas and the sealing chosen.

Anmerkung:

Berücksichtigen Sie für die Schnitliste die geeigneten Bearbeitungs- und Schweißtoleranzen in Bezug auf die Verlegebereiche und die ausgewählten Dichtungen.

Remarque:

Pour la liste de coupe, tenez compte des tolérances d'usinage et de soudage appropriées en fonction des zones de pose et des joints choisis.

Profile matching

Kombination von Profile

Combinaison de profils

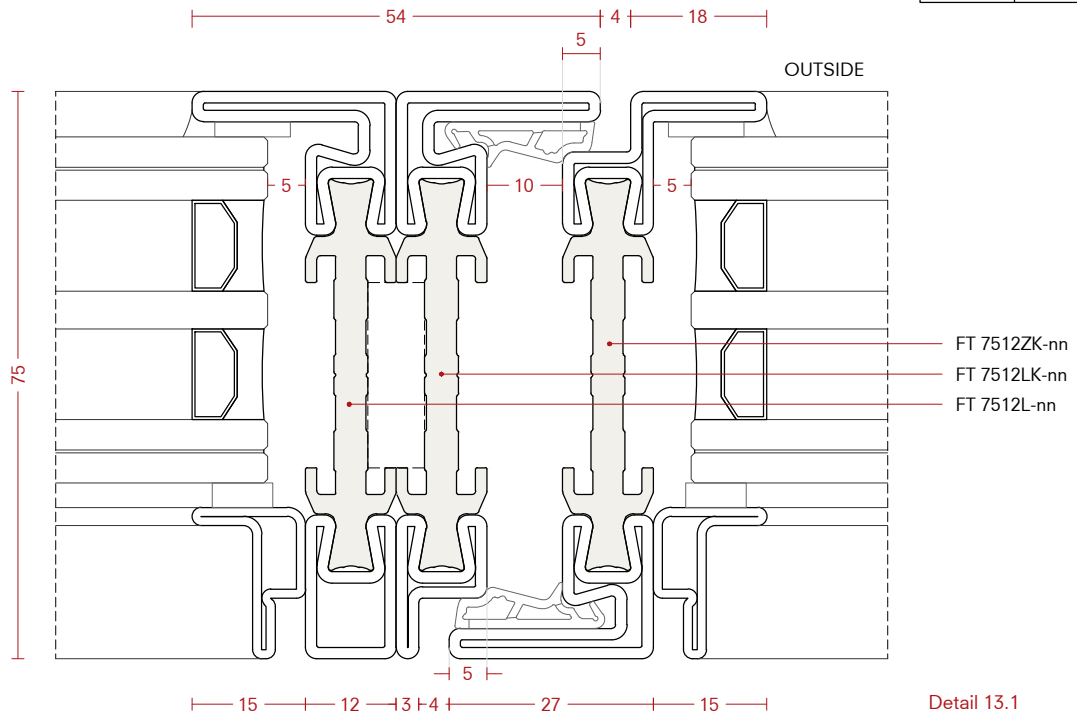
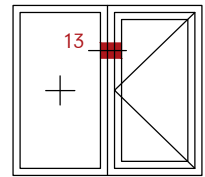

Detail 13.1

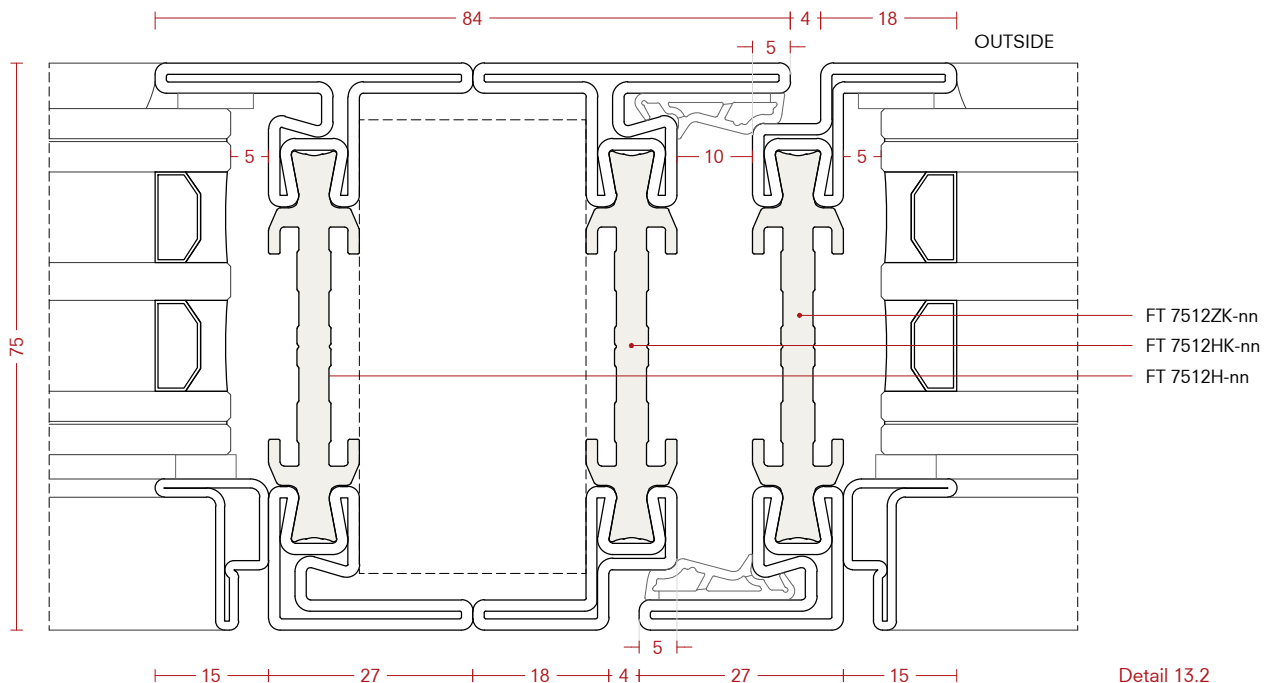

Detail 13.2

Note:

For the cutting list, consider the appropriate machining and welding tolerances in relation to the laying areas and the sealing chosen.

Anmerkung:

Berücksichtigen Sie für die Schnittliste die geeigneten Bearbeitungs- und Schweißtoleranzen in Bezug auf die Verlegebereiche und die ausgewählten Dichtungen.

Remarque:

Pour la liste de coupe, tenez compte des tolérances d'usinage et de soudage appropriées en fonction des zones de pose et des joints choisis.

Profile matching

Kombination von Profile

Combinaison de profils

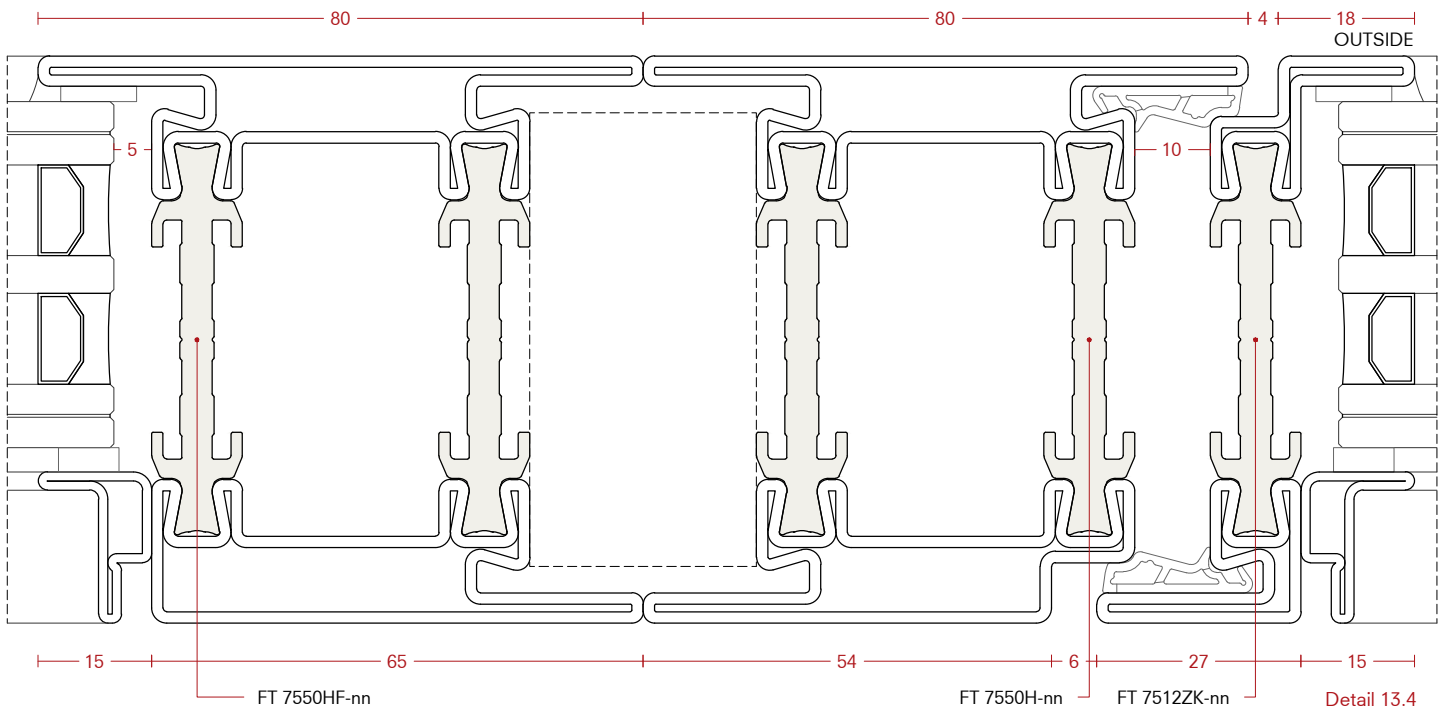
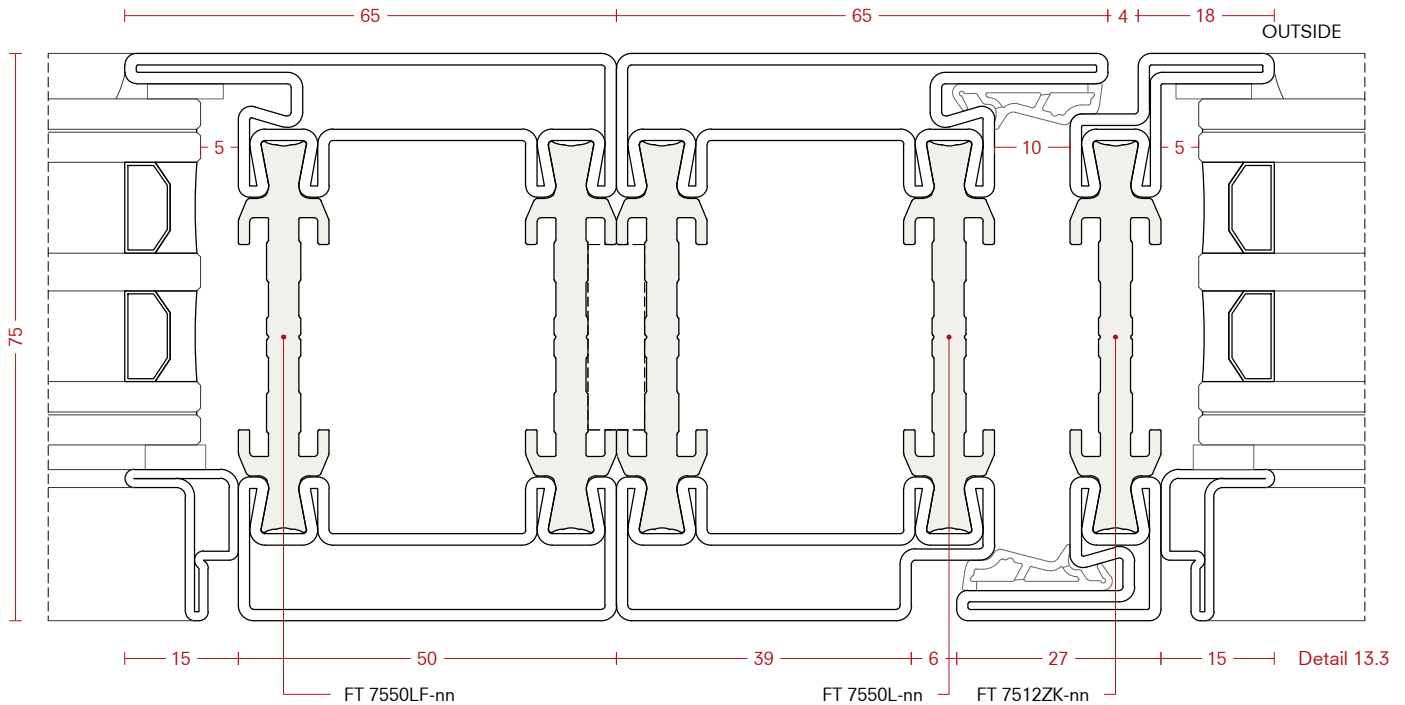
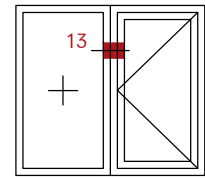

Note:

For the cutting list, consider the appropriate machining and welding tolerances in relation to the laying areas and the sealing chosen.

Anmerkung:

Berücksichtigen Sie für die Schnitliste die geeigneten Bearbeitungs- und Schweißtoleranzen in Bezug auf die Verlegebereiche und die ausgewählten Dichtungen.

Remarque:

Pour la liste de coupe, tenez compte des tolérances d'usinage et de soudage appropriées en fonction des zones de pose et des joints choisis.

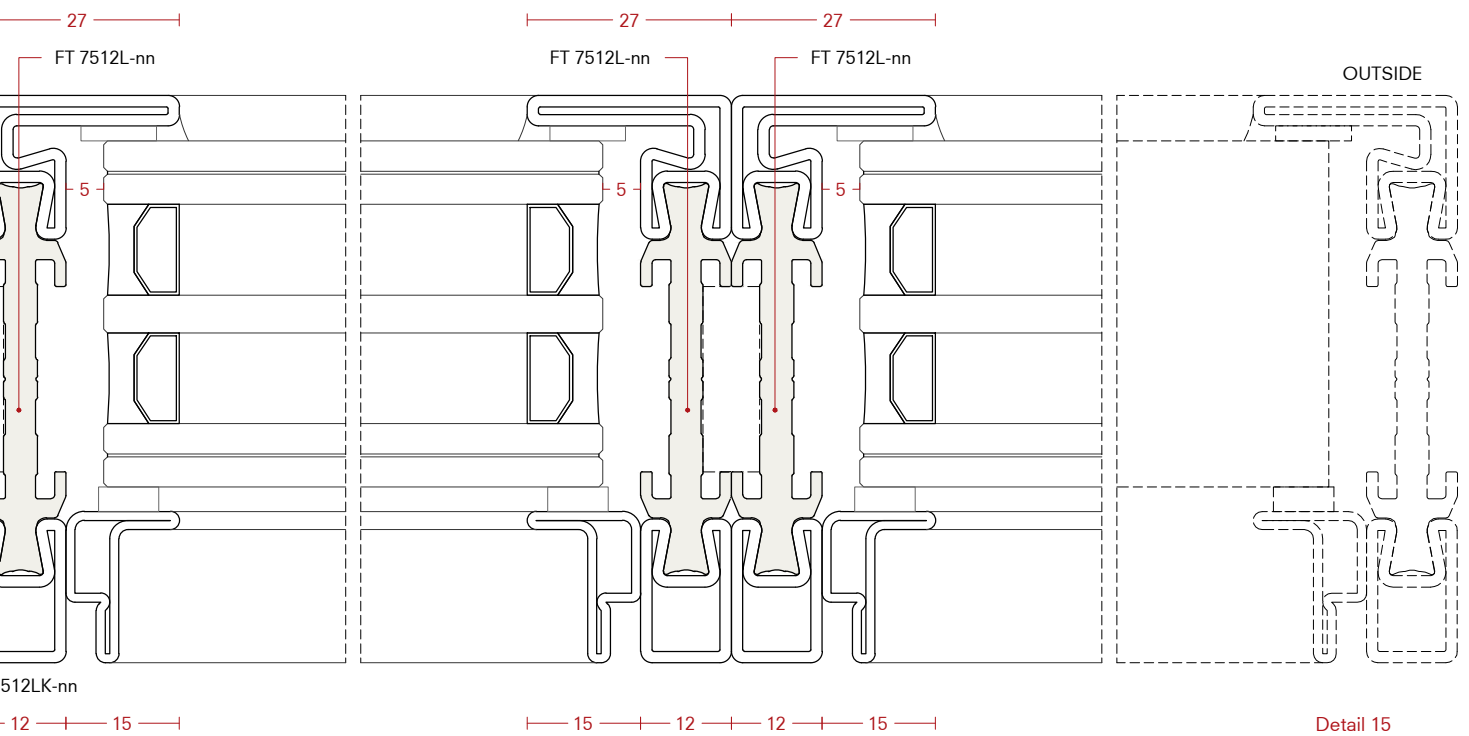
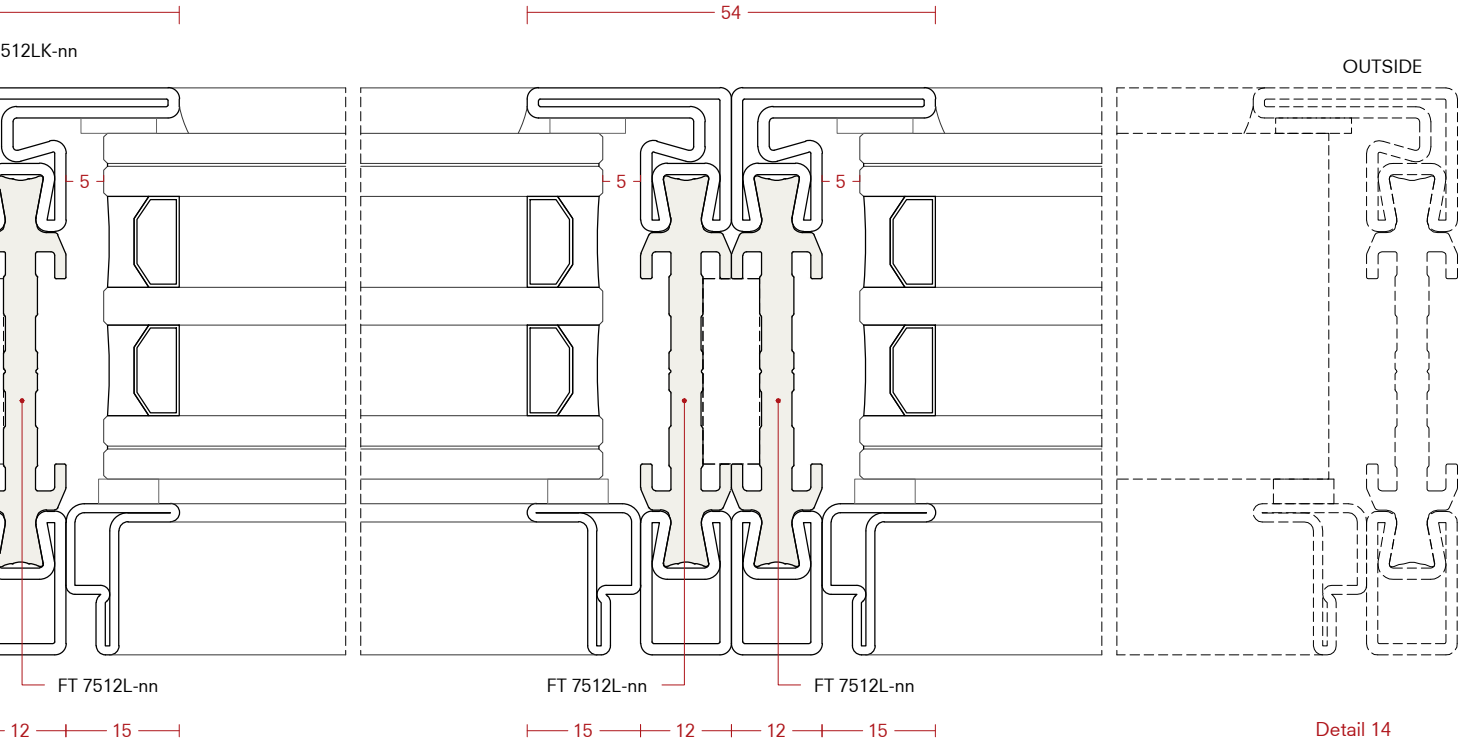
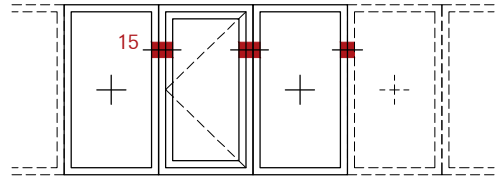
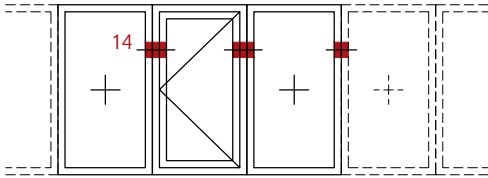

Door details

Details Türen

Détails portes

4.2

Legend

+ = Fixed
— = Open in
- - - = Open out
Dimensions in: mm
Scale 1:1 - 1:2

Legende

+ = Fixed
— = Innen öffnend
- - - = Außen öffnend
Einheit in: mm
Maßstab 1:1 - 1:2

Légende

+ = Fixe
— = Ouvr. intérieur
- - - = Ouvr. extérieur
Dimensions en: mm
Échelle 1:1 - 1:2

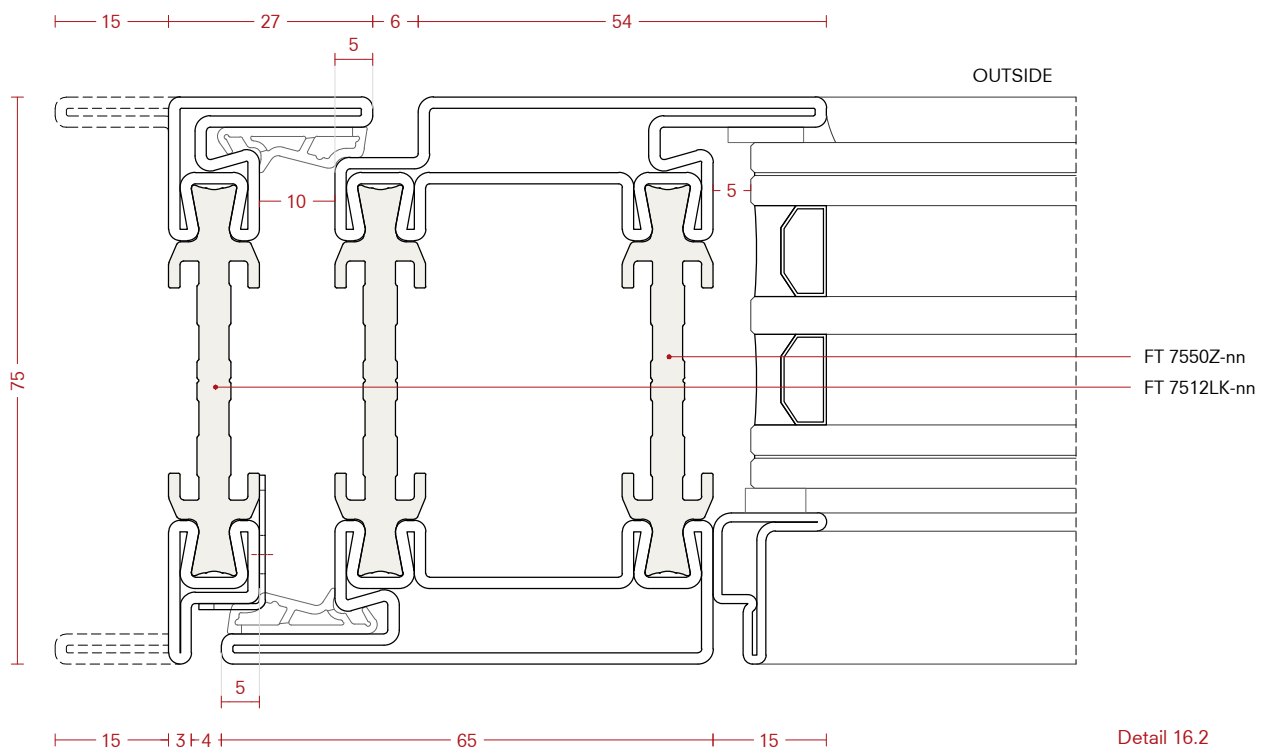
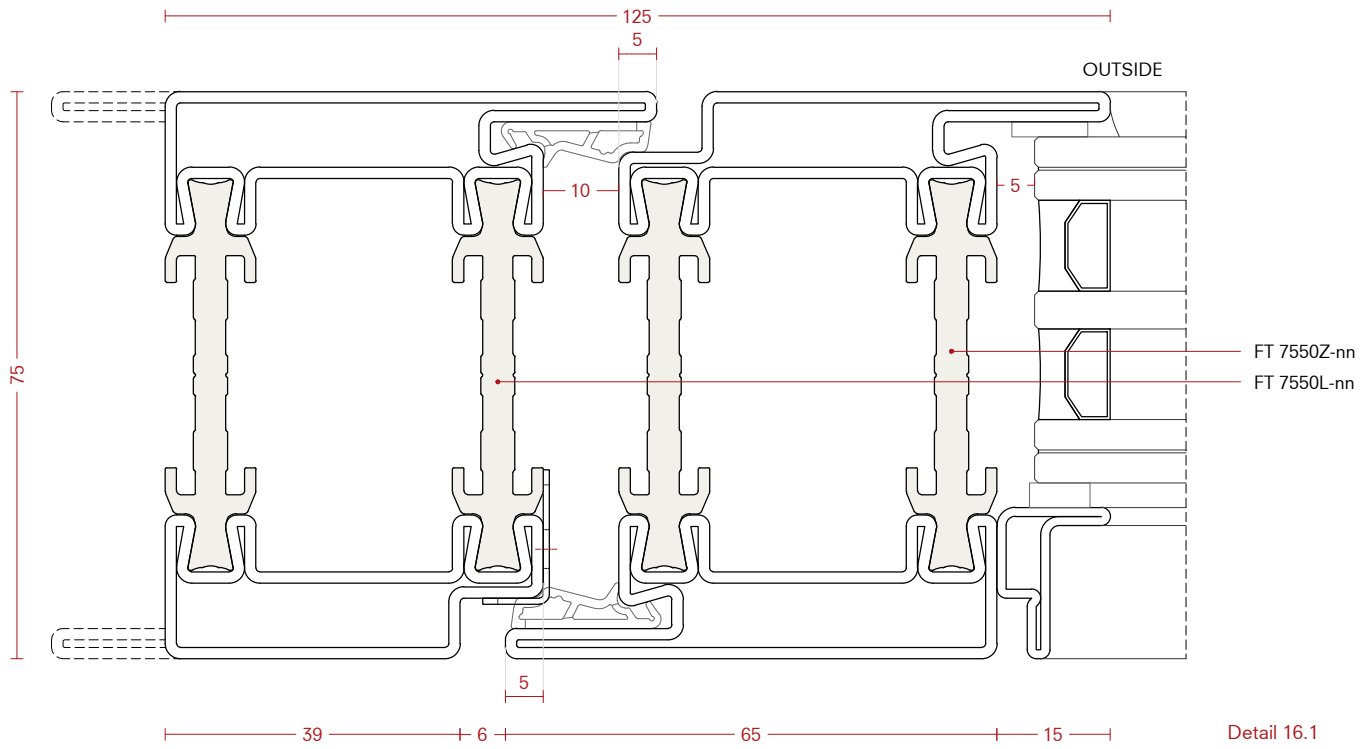
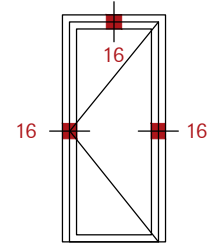

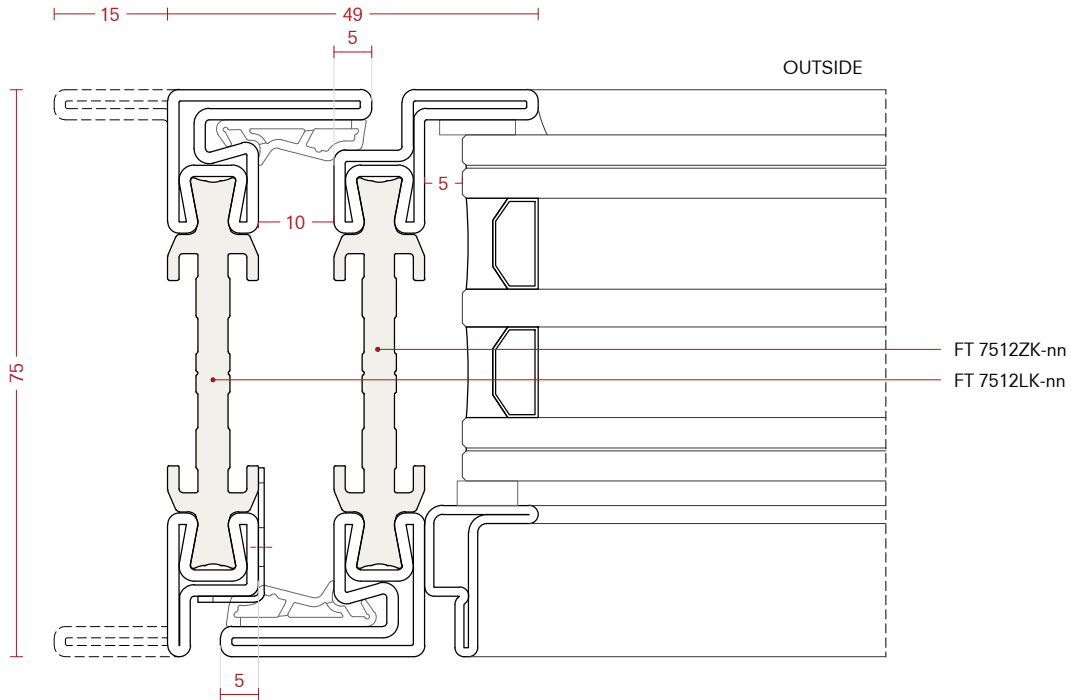
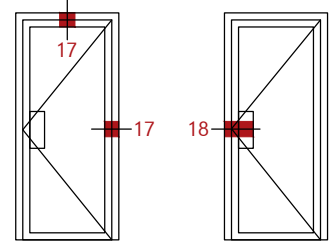

Detail 17

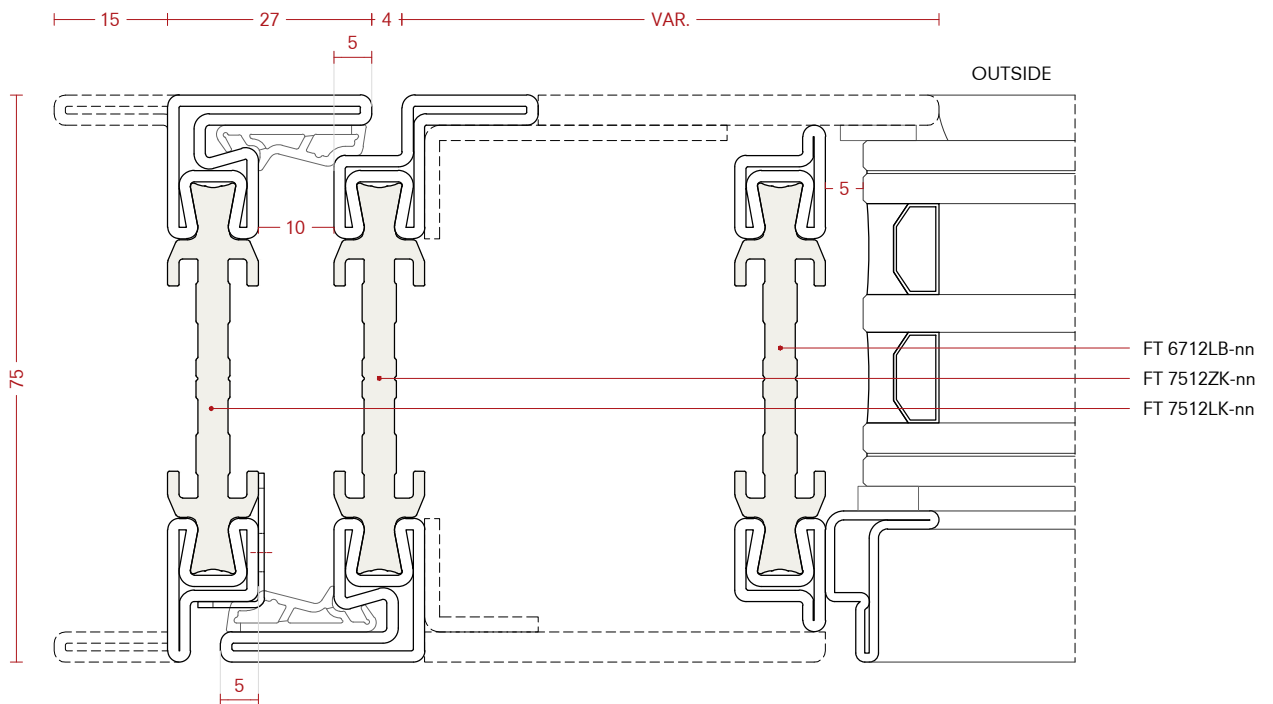

Detail 18

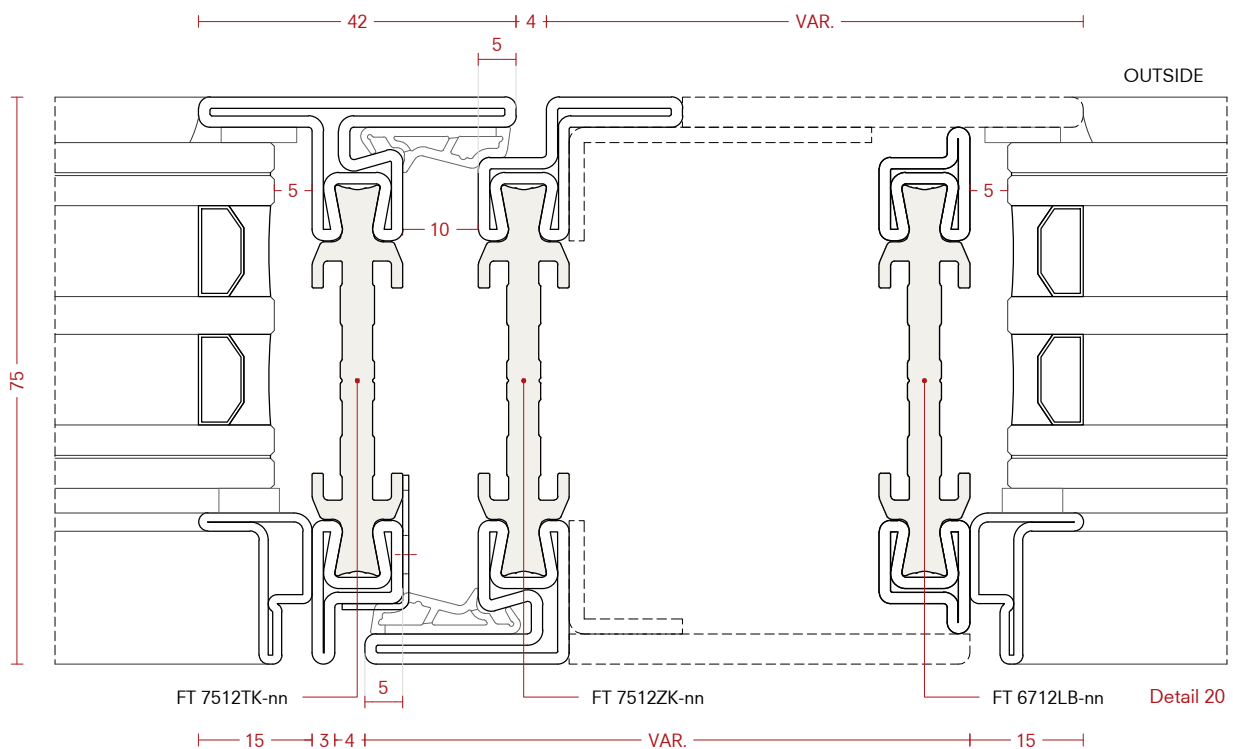
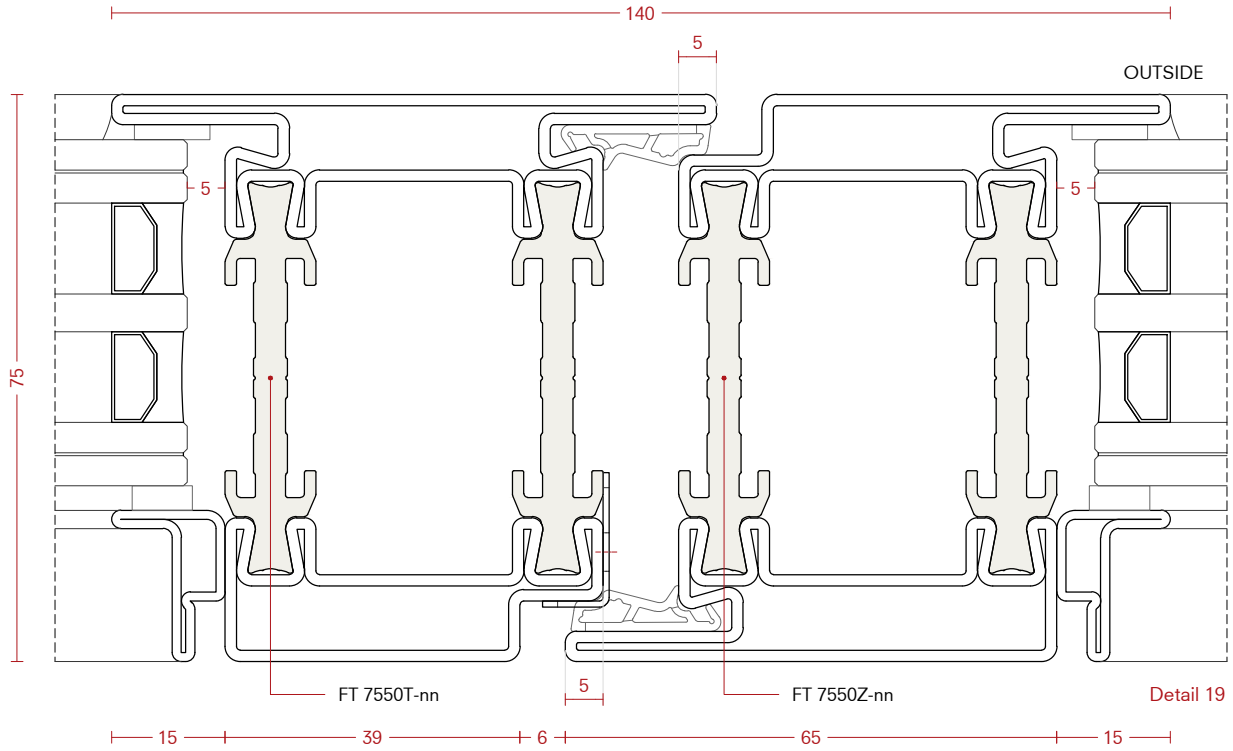
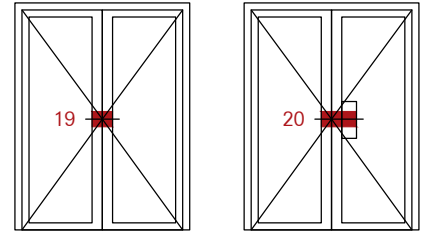

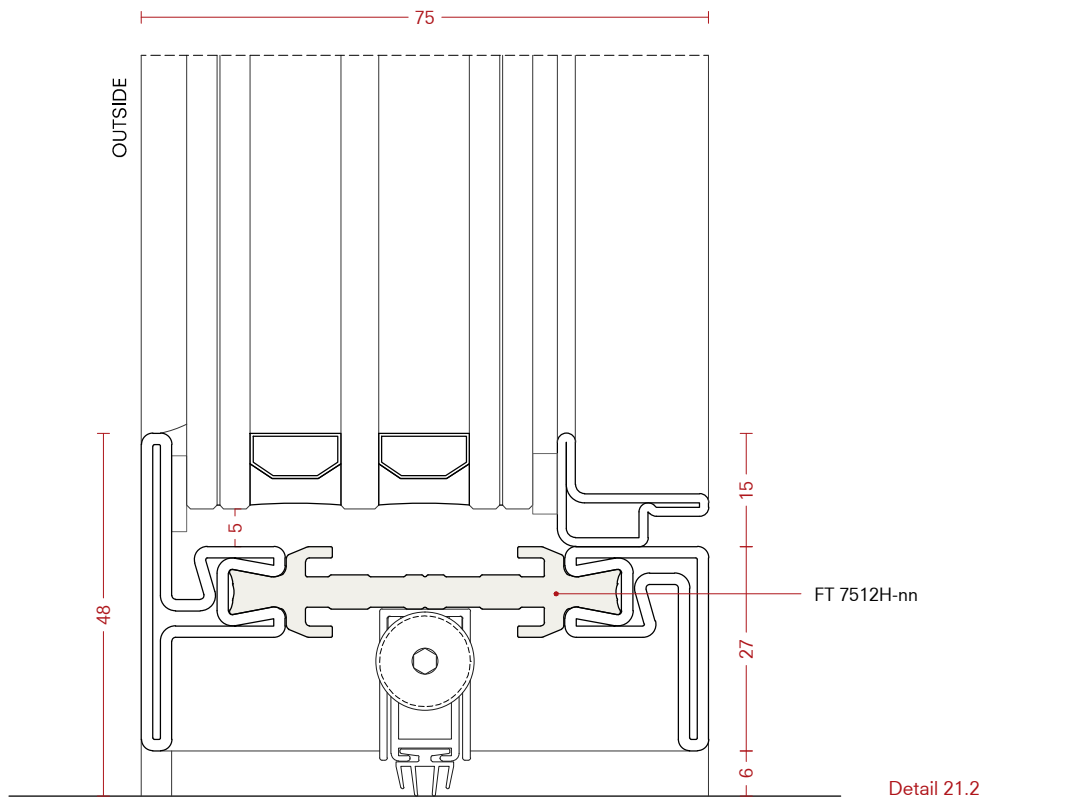
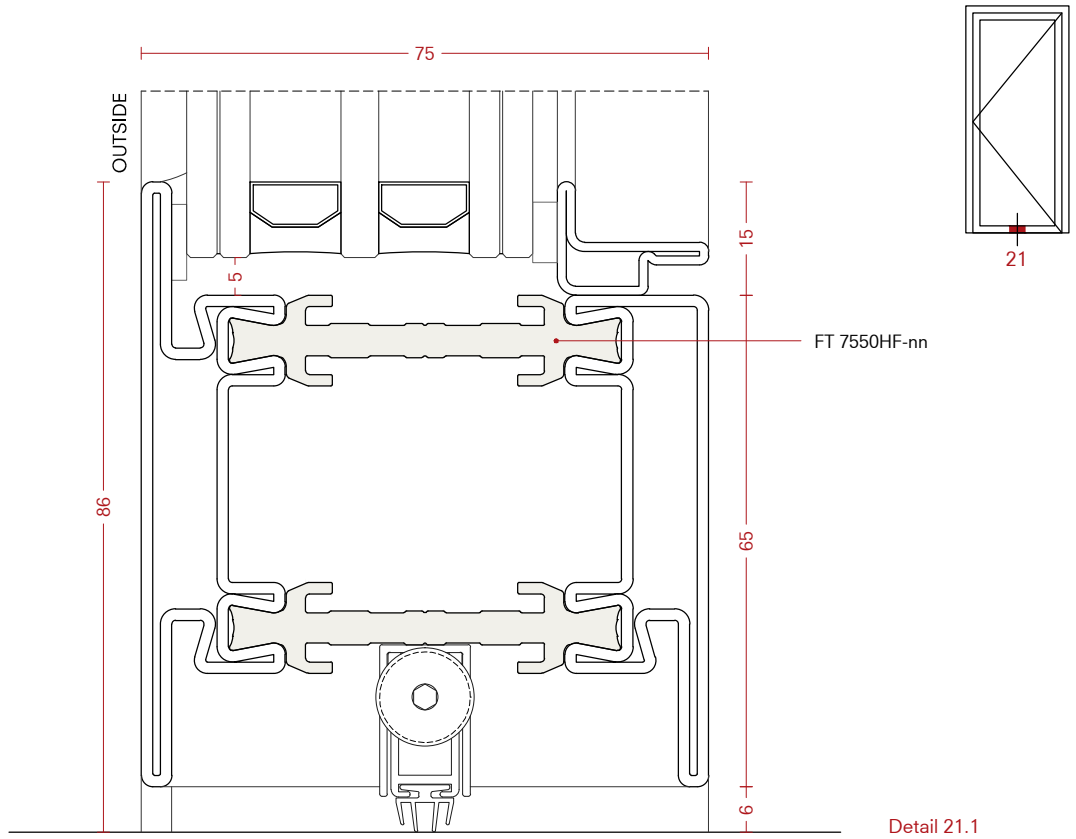

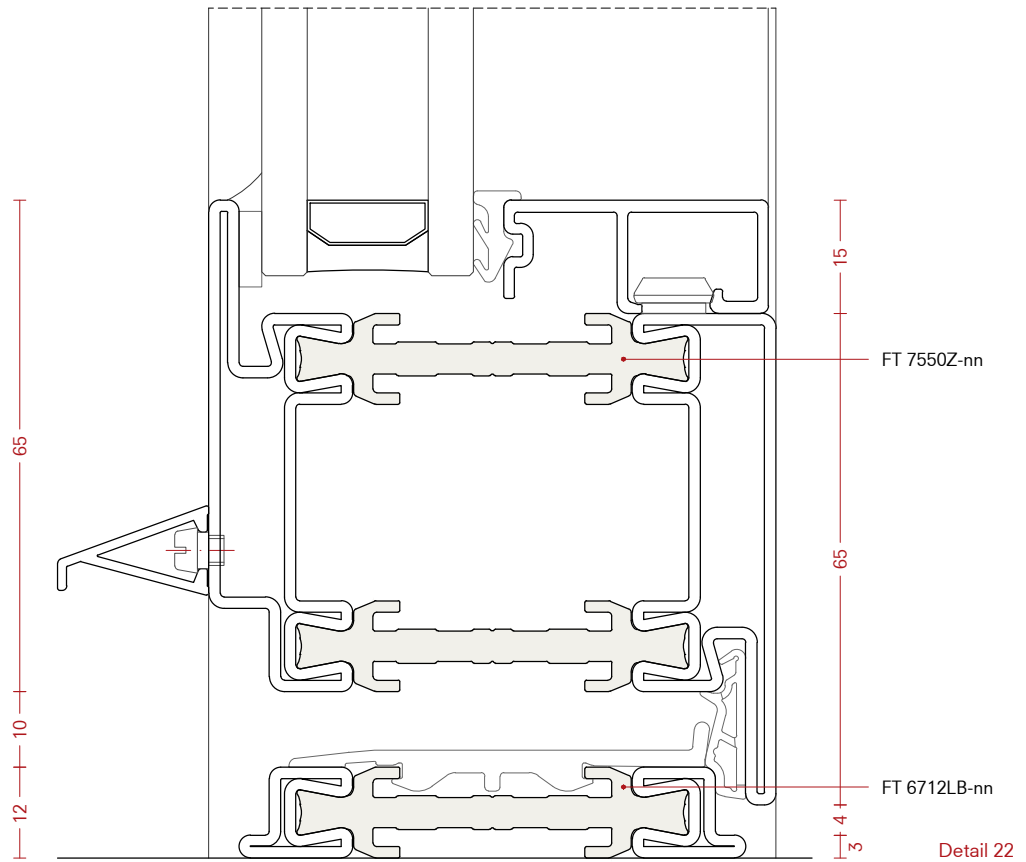
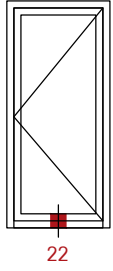

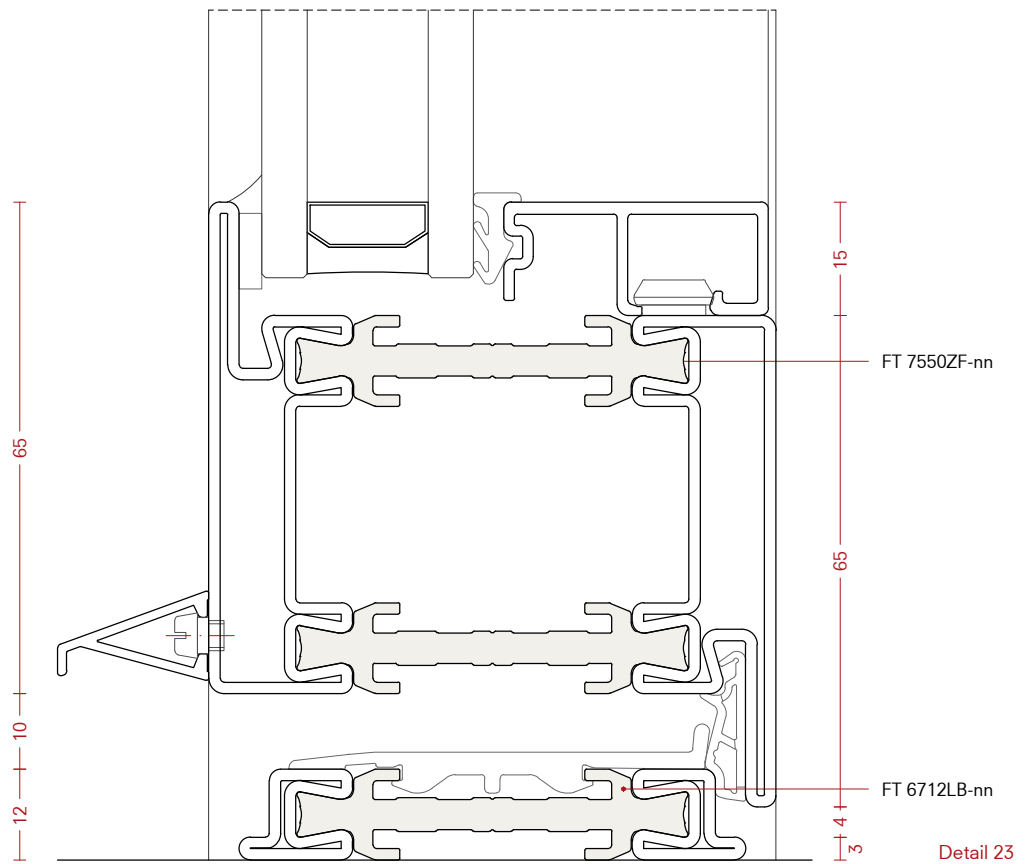
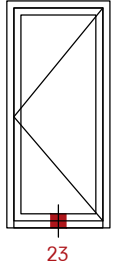

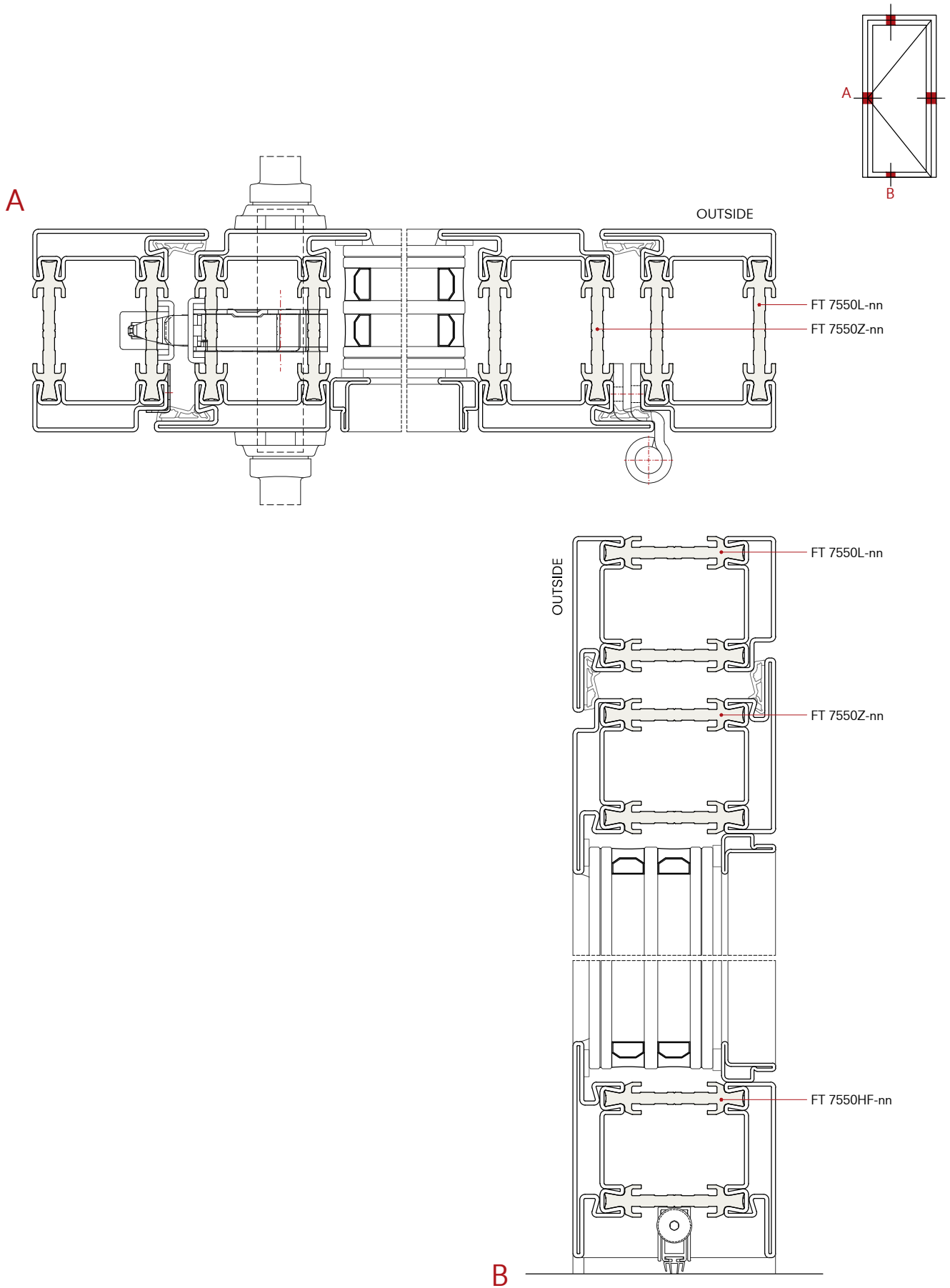

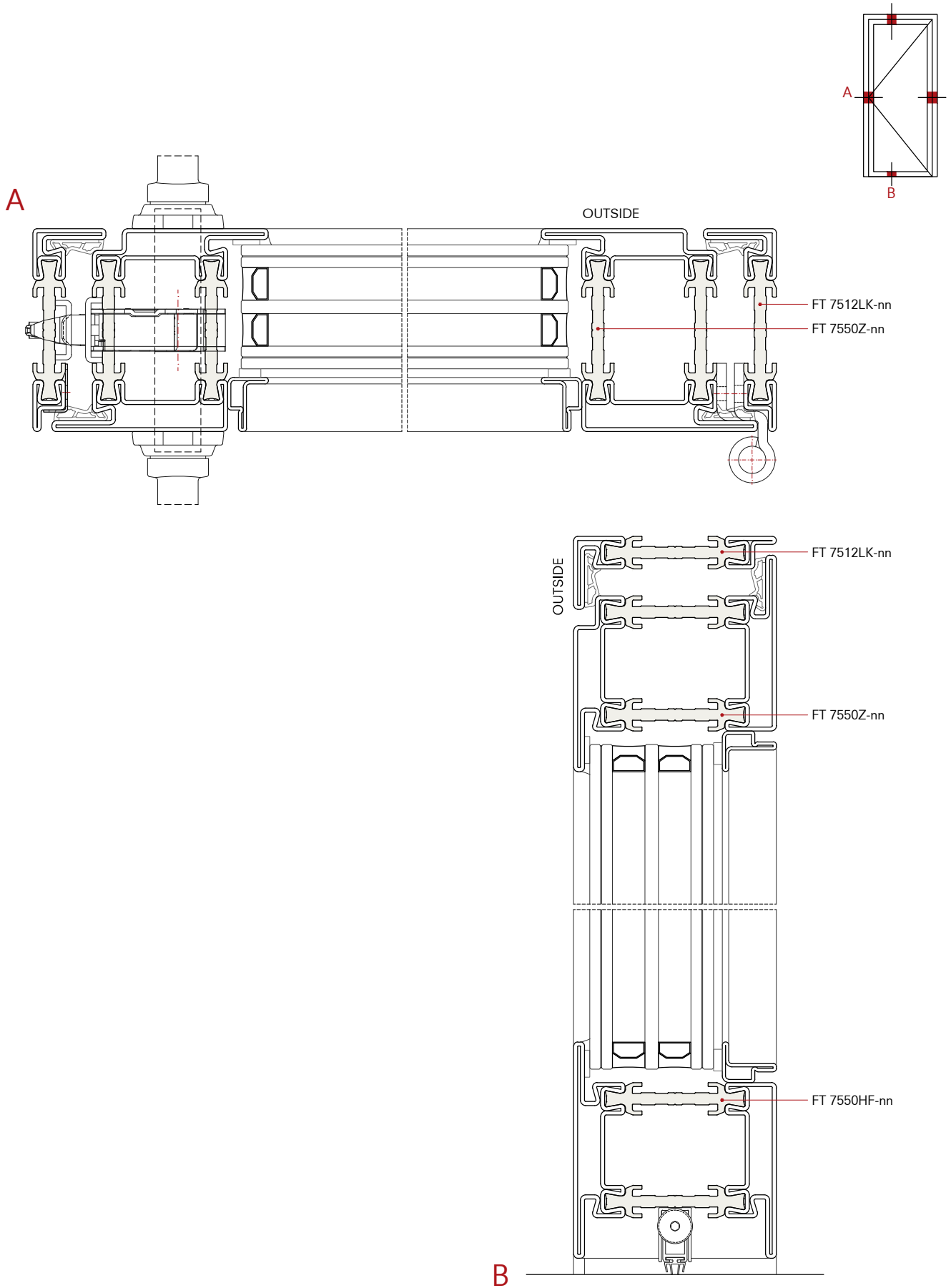

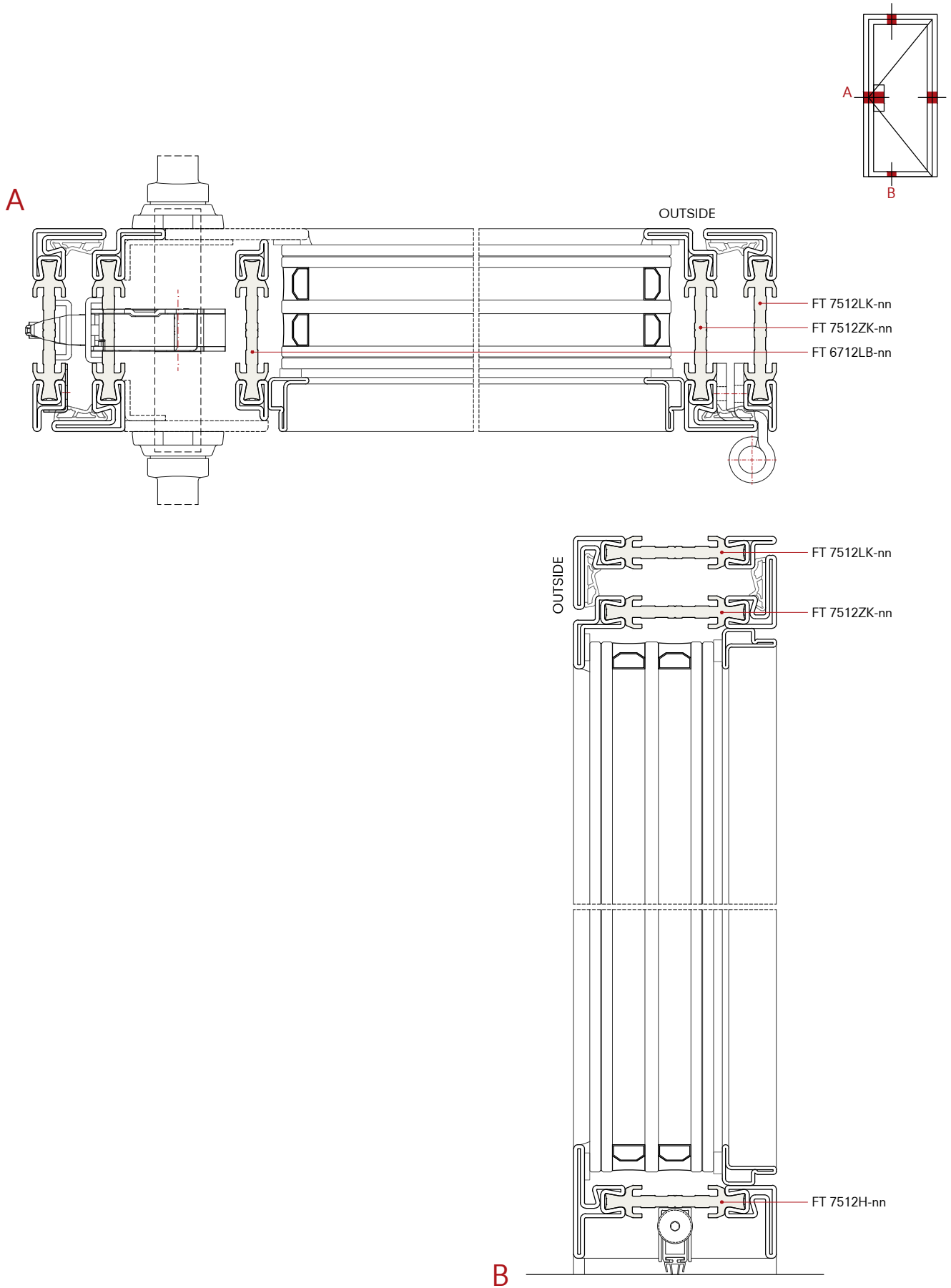

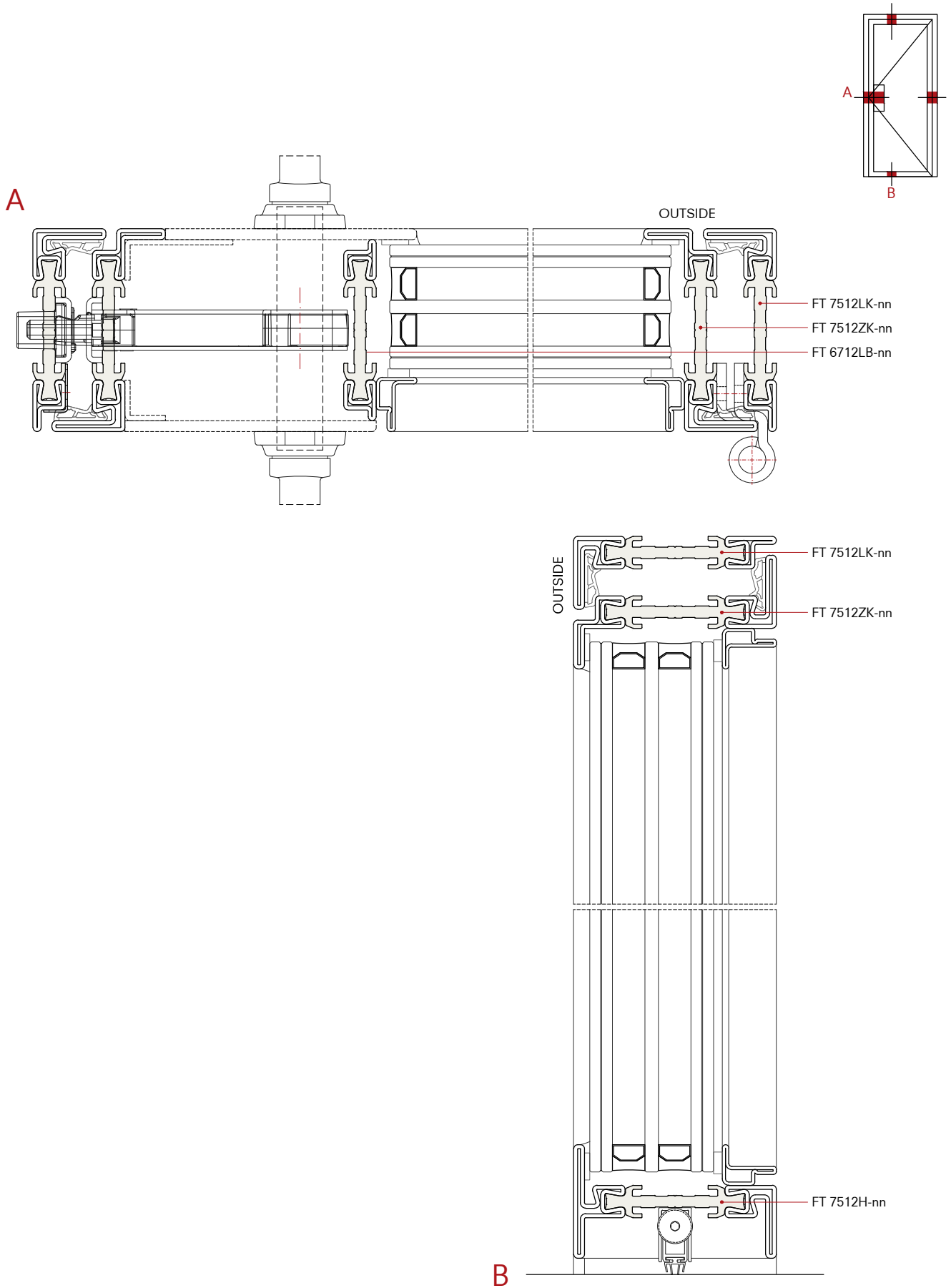

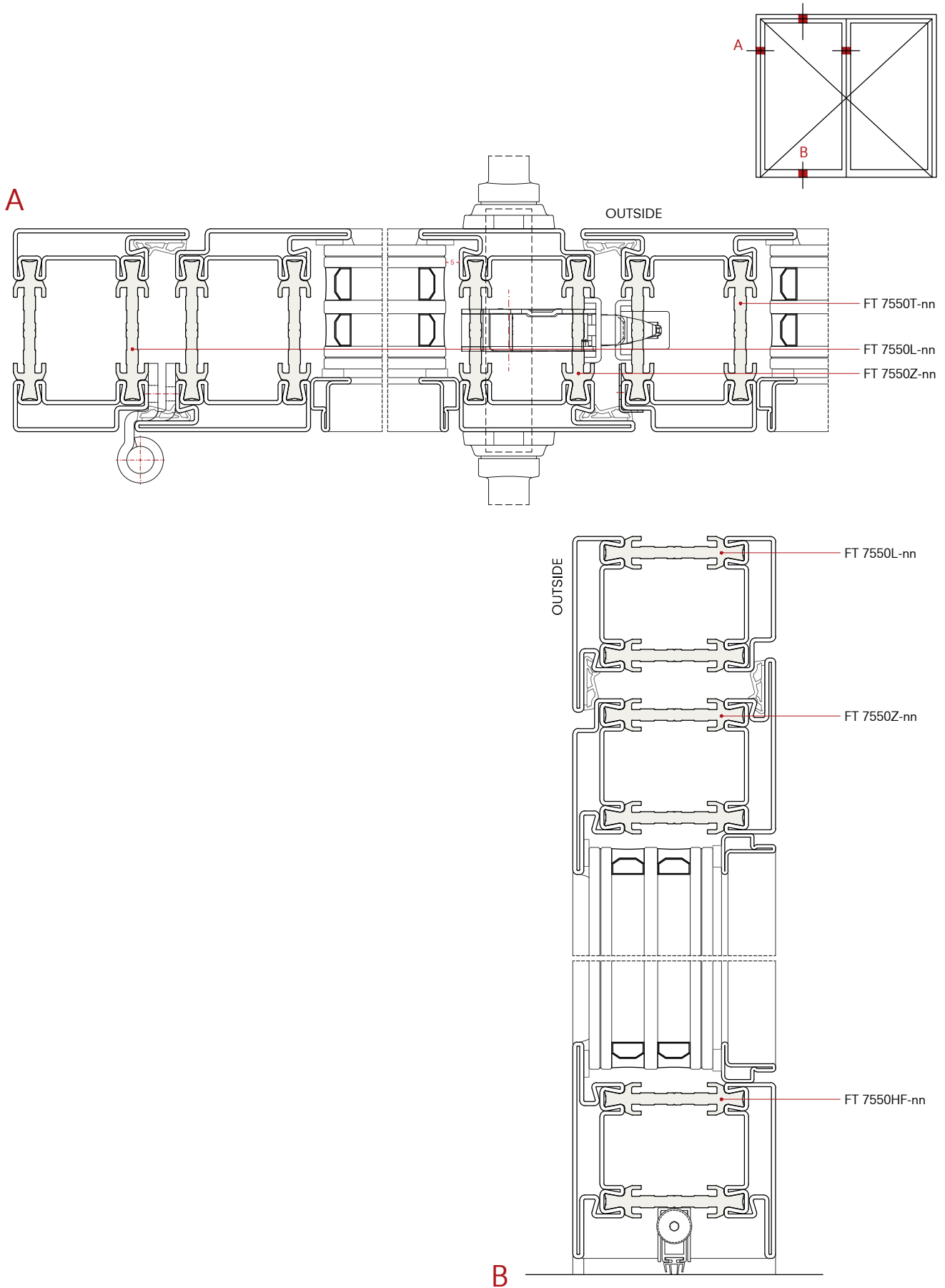

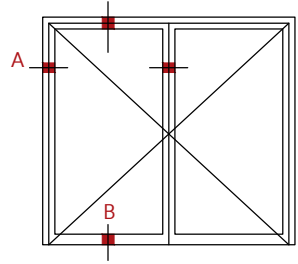

A

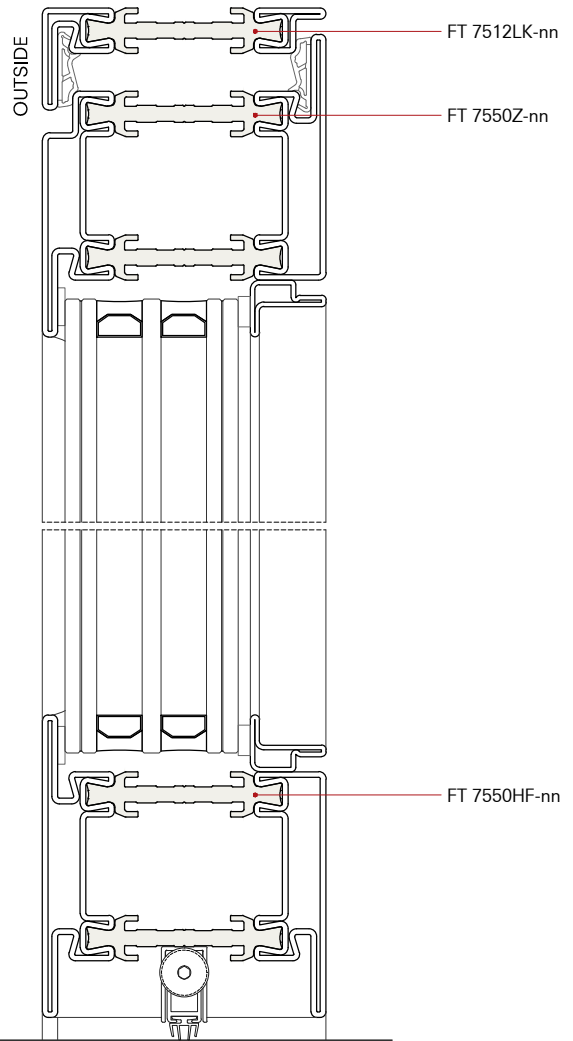
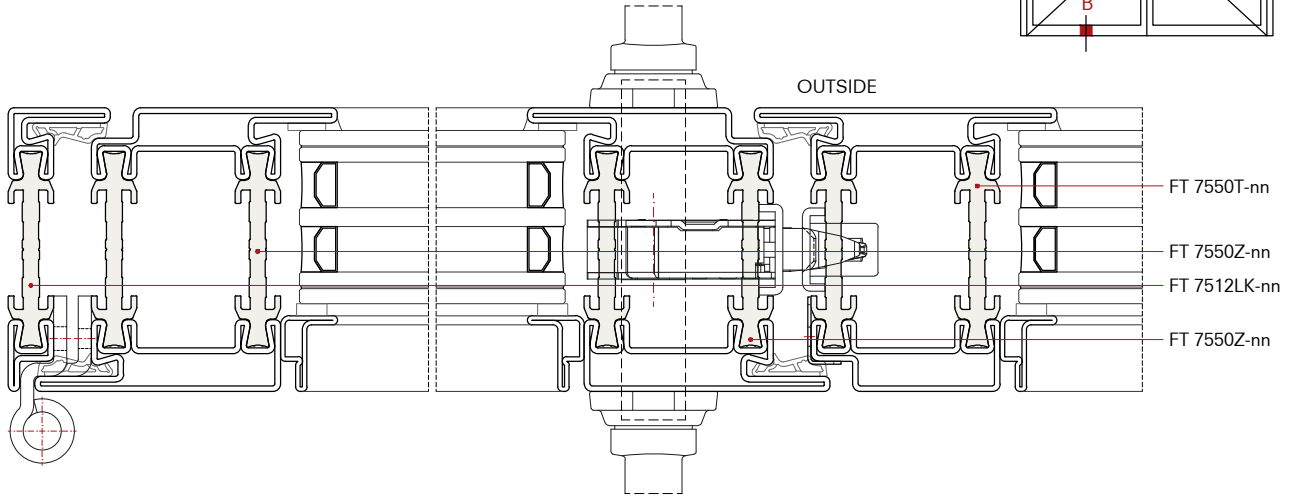

B

A

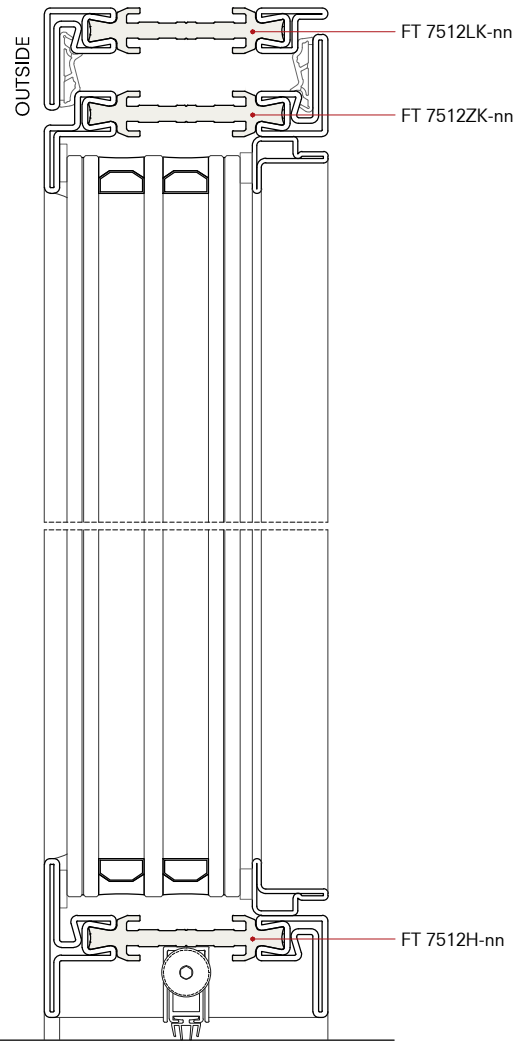
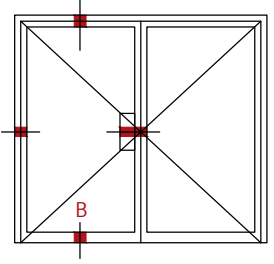
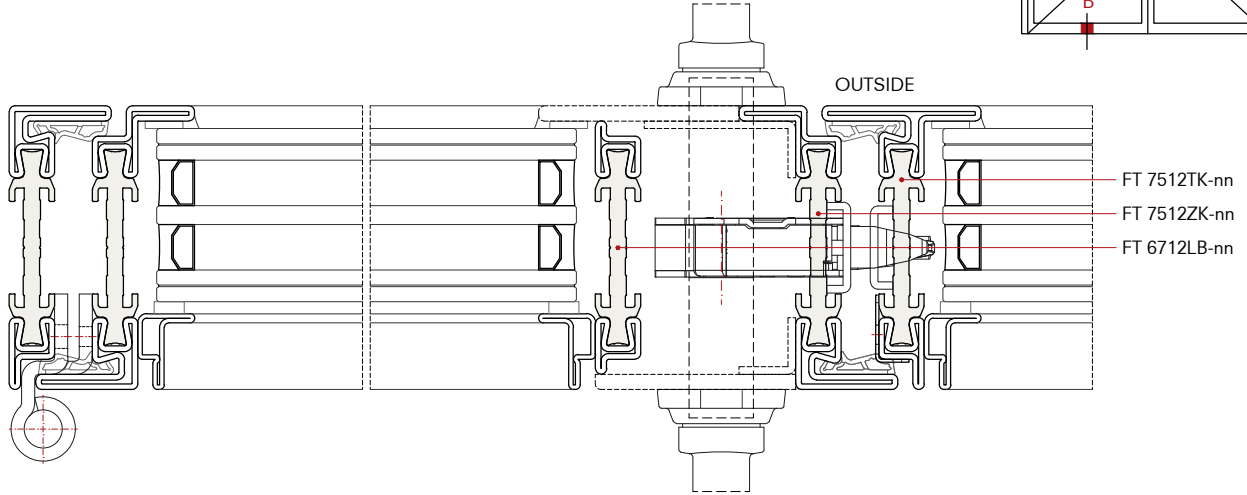

B

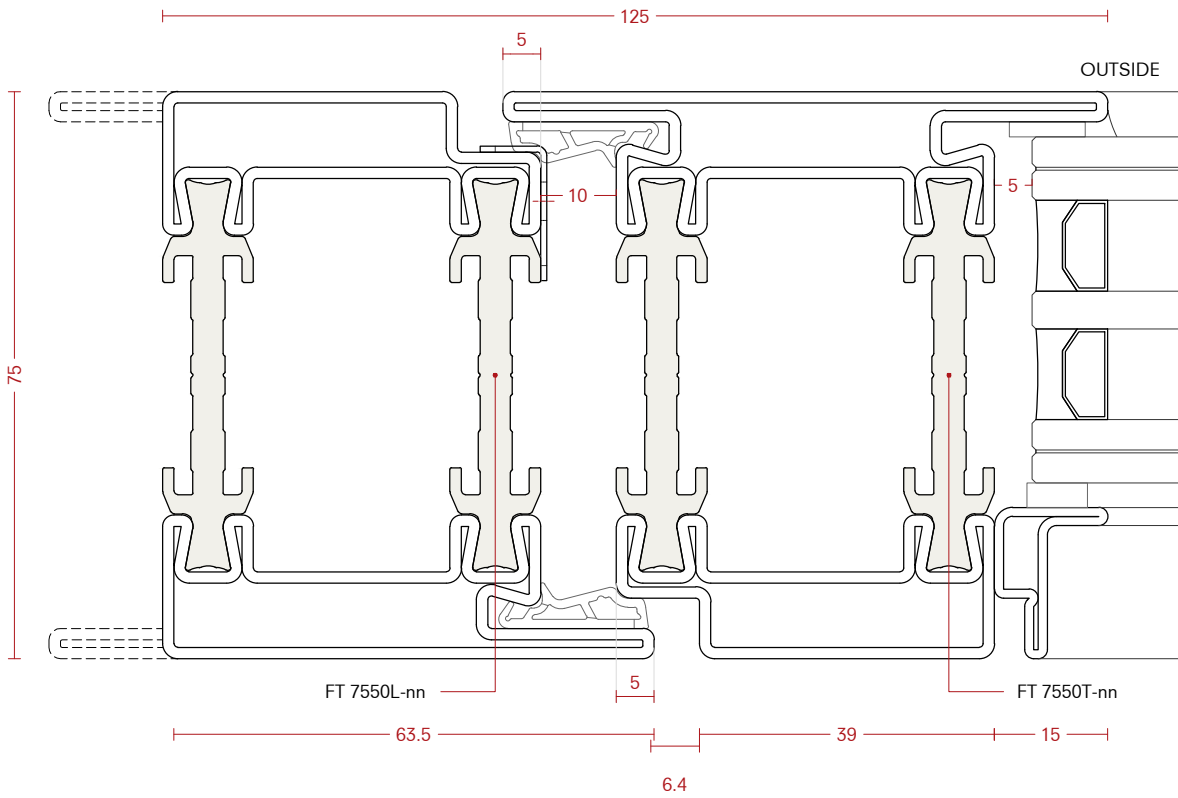
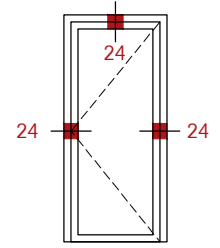

Detail 24

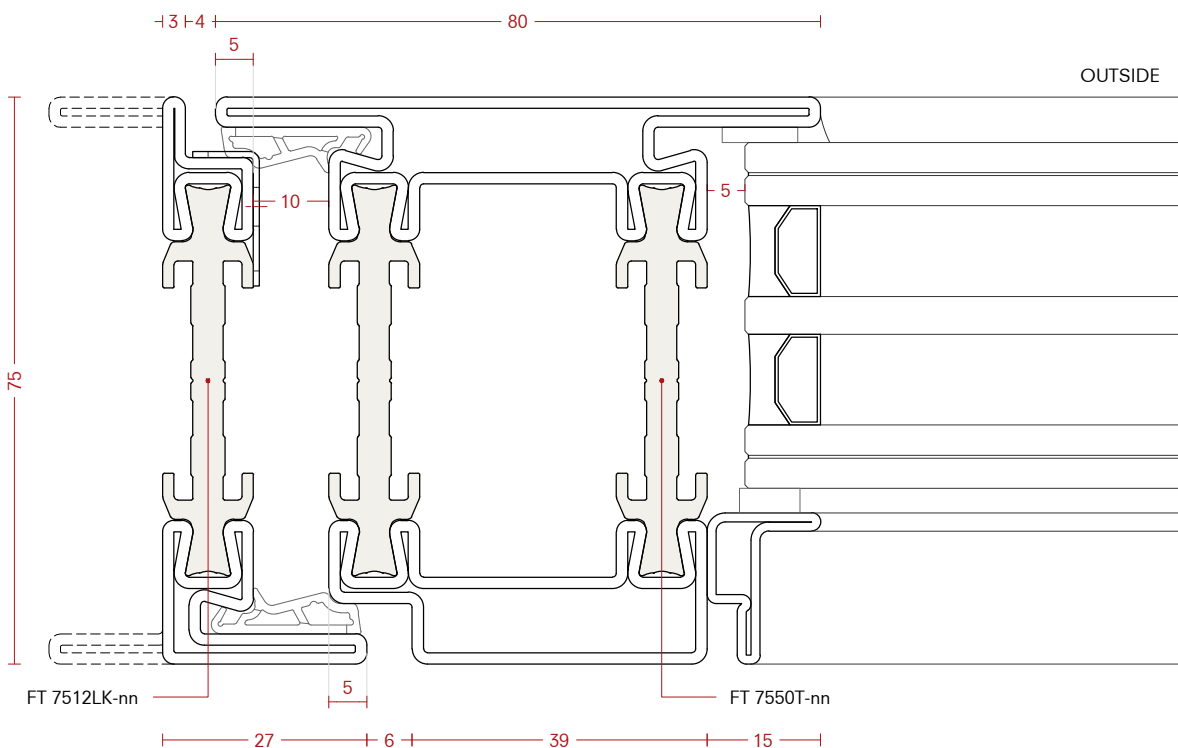

Detail 24

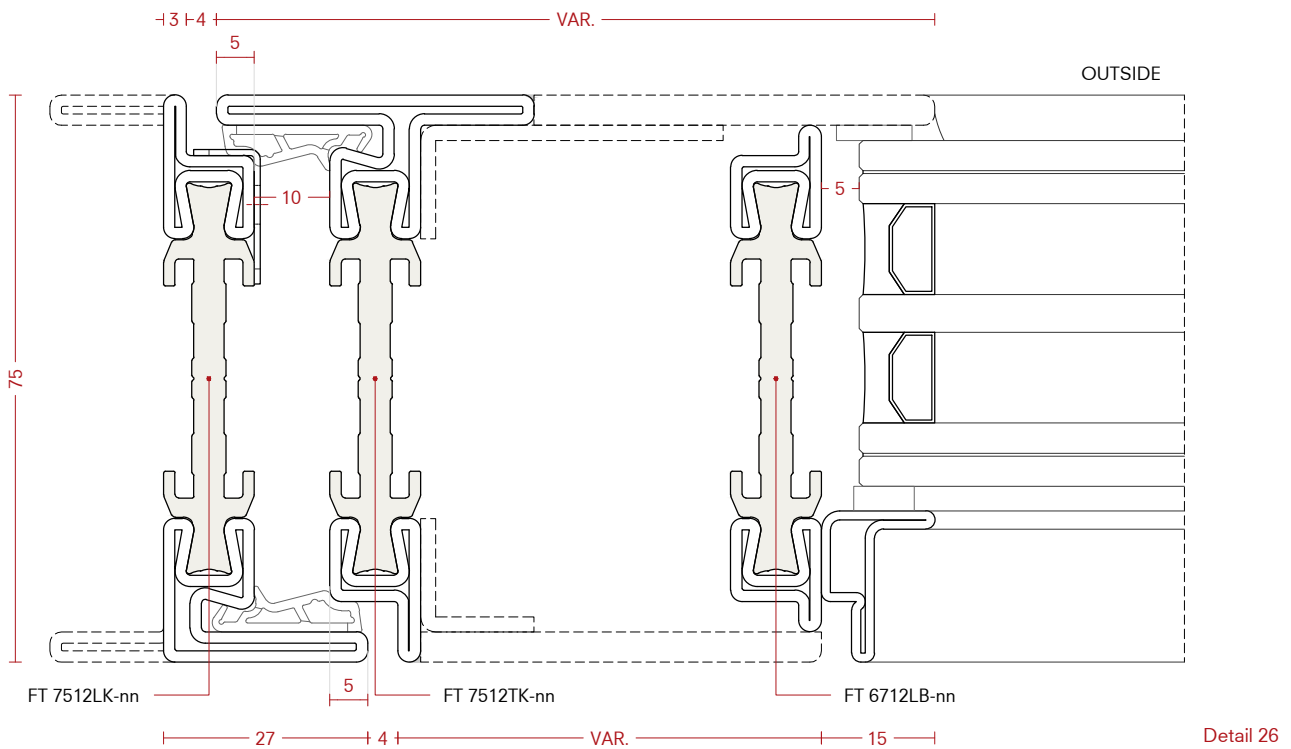
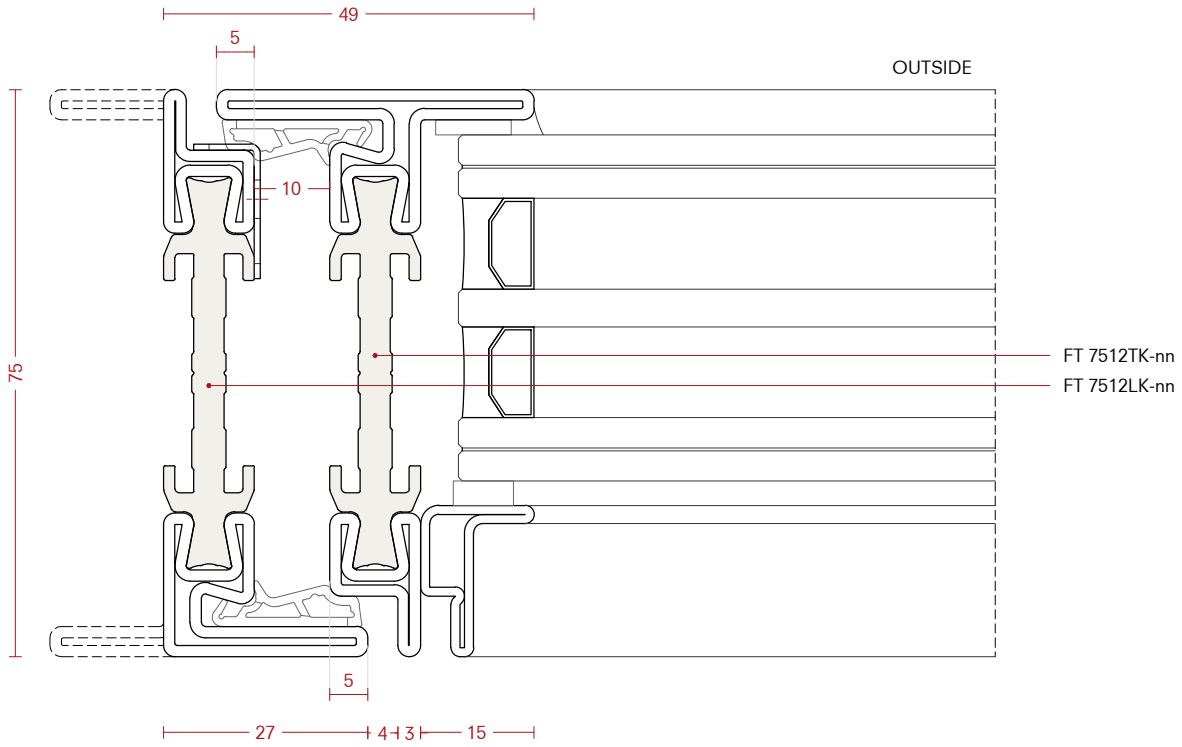
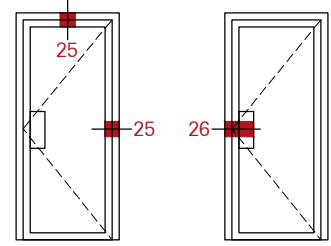

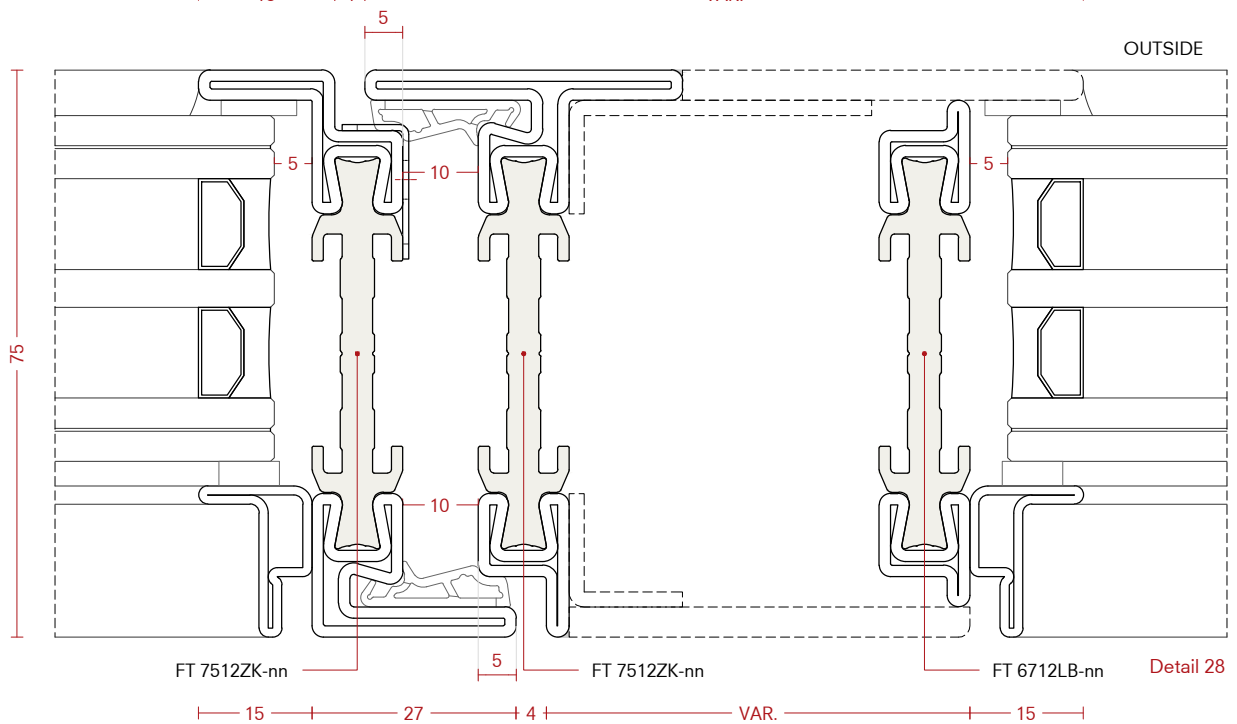
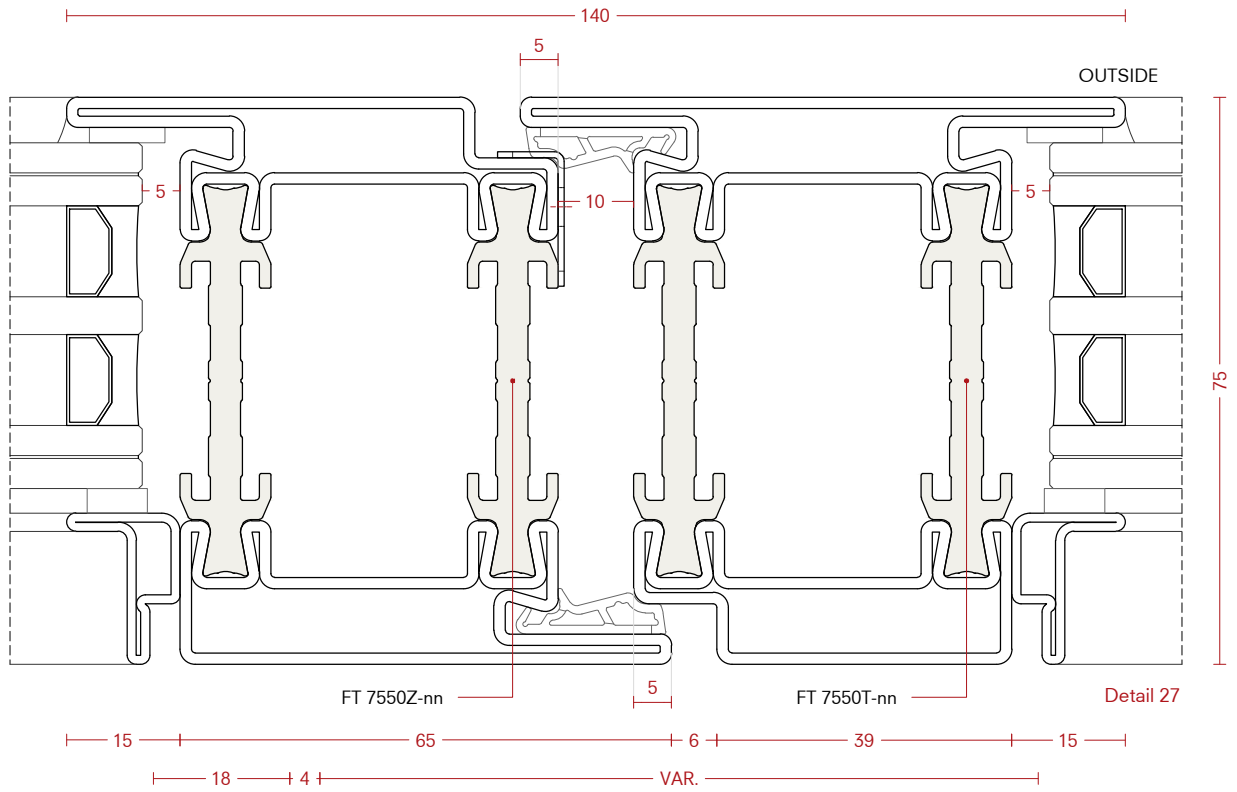
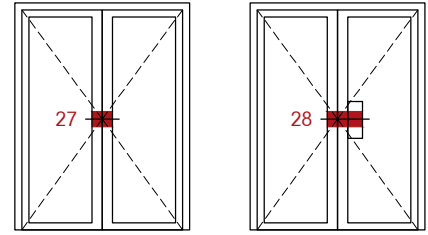

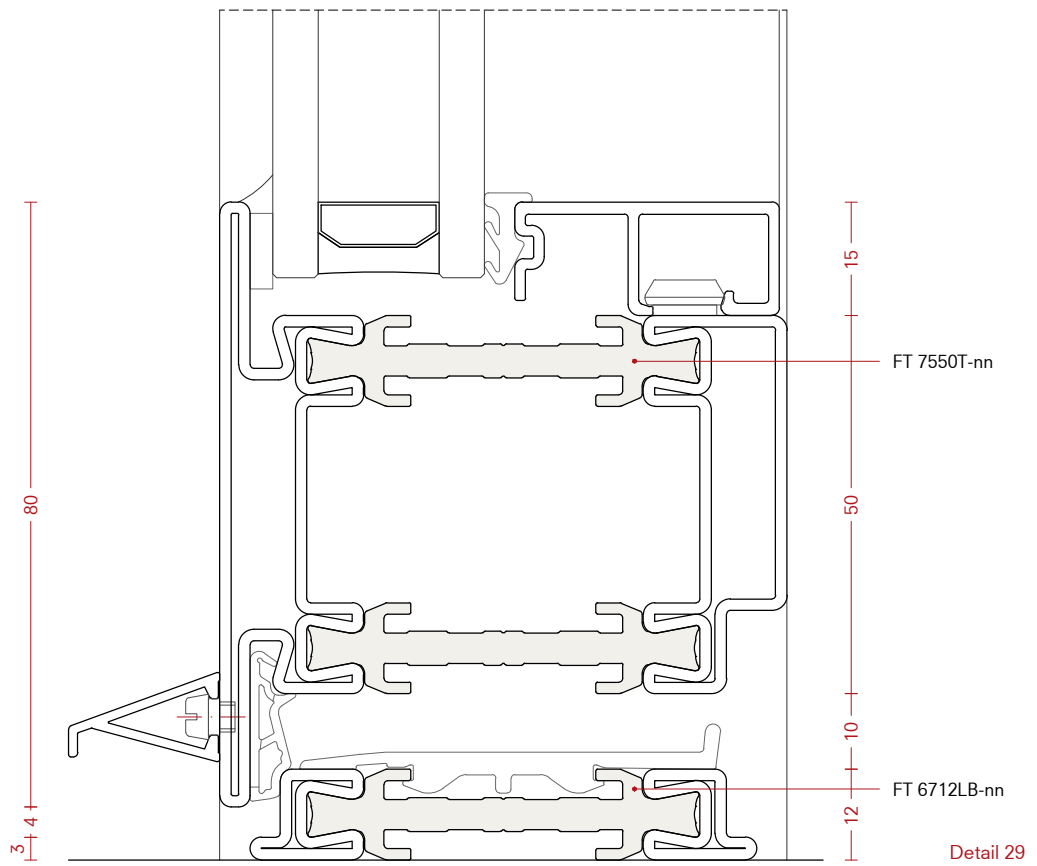
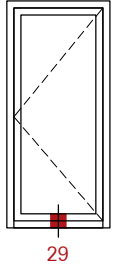

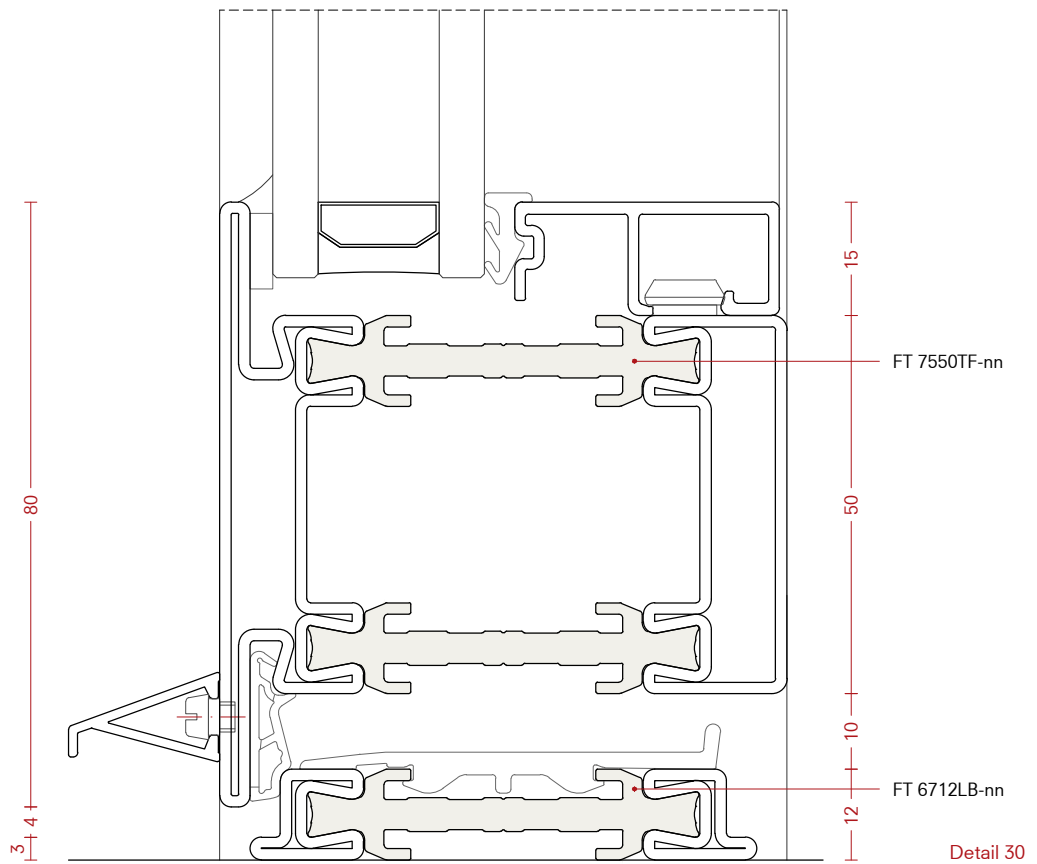
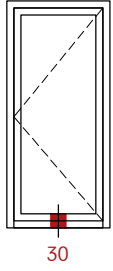

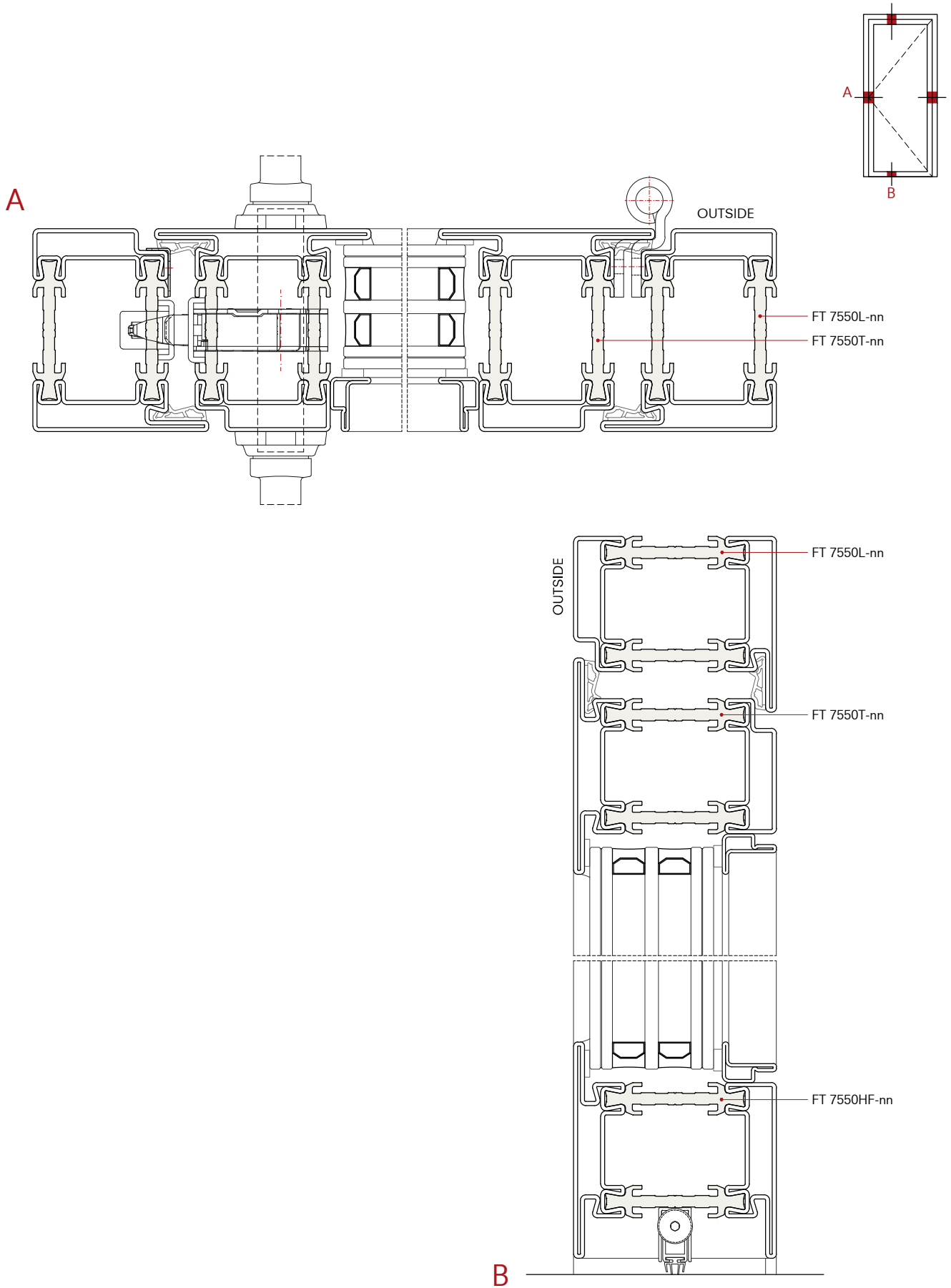

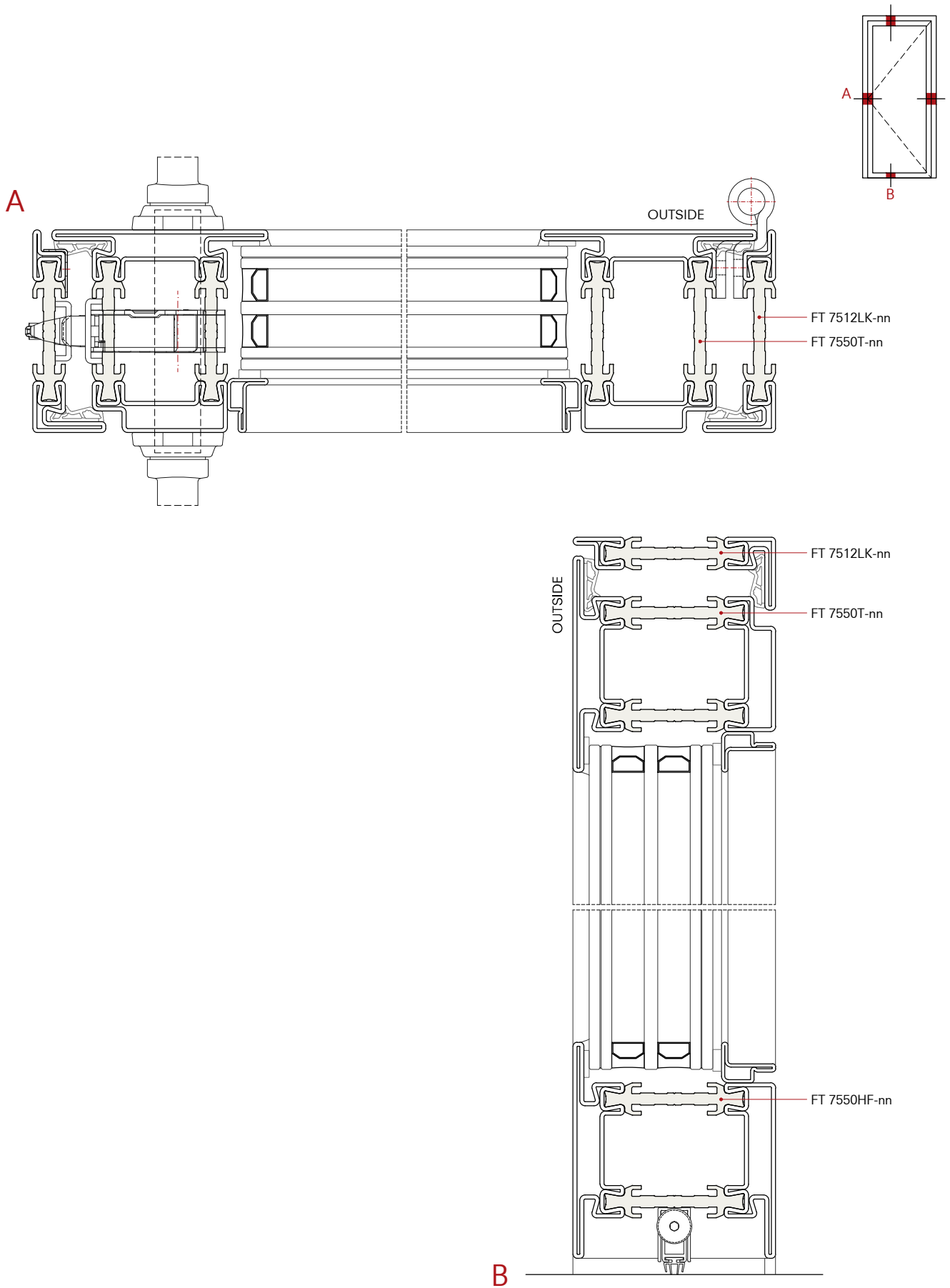

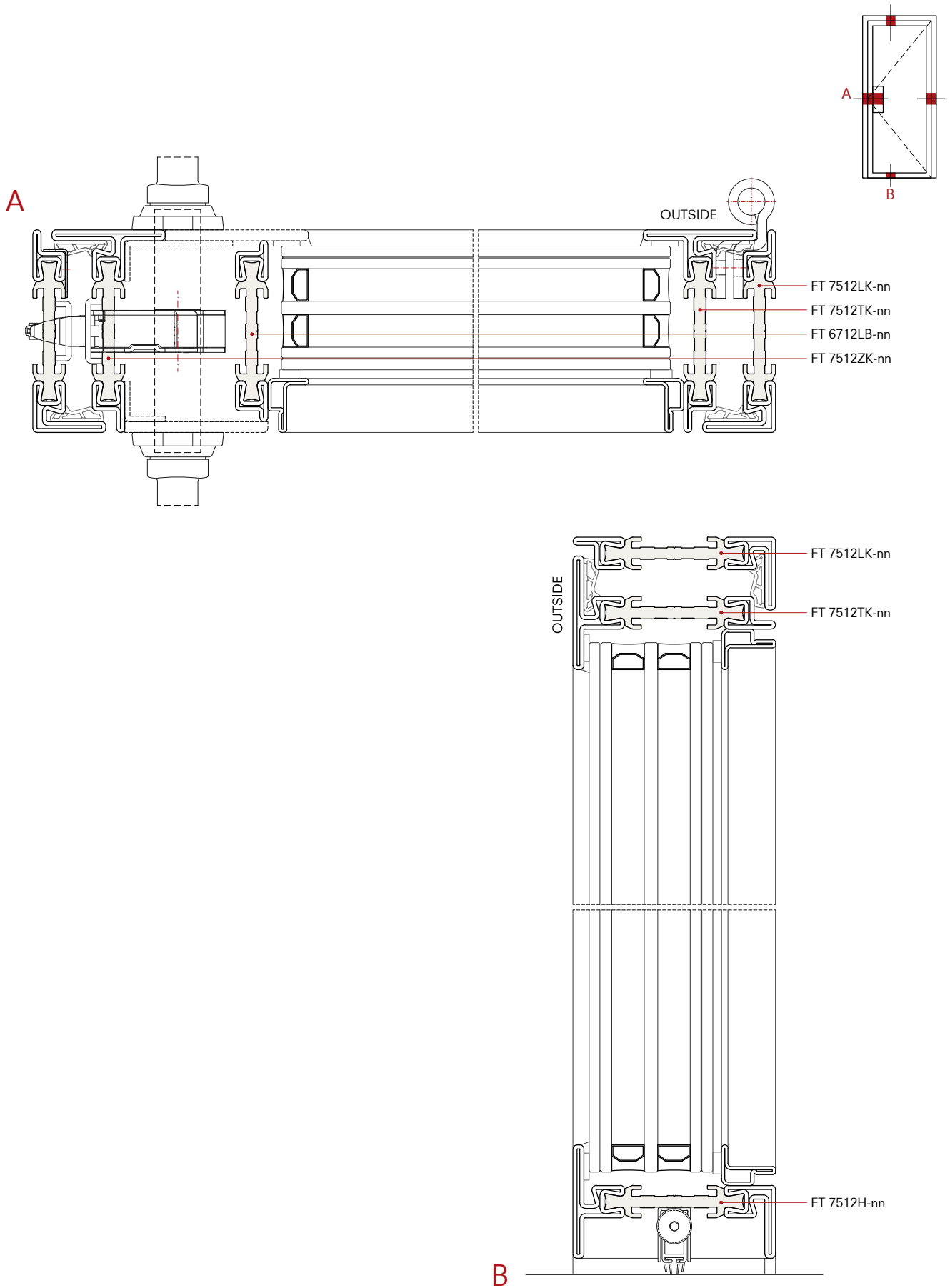

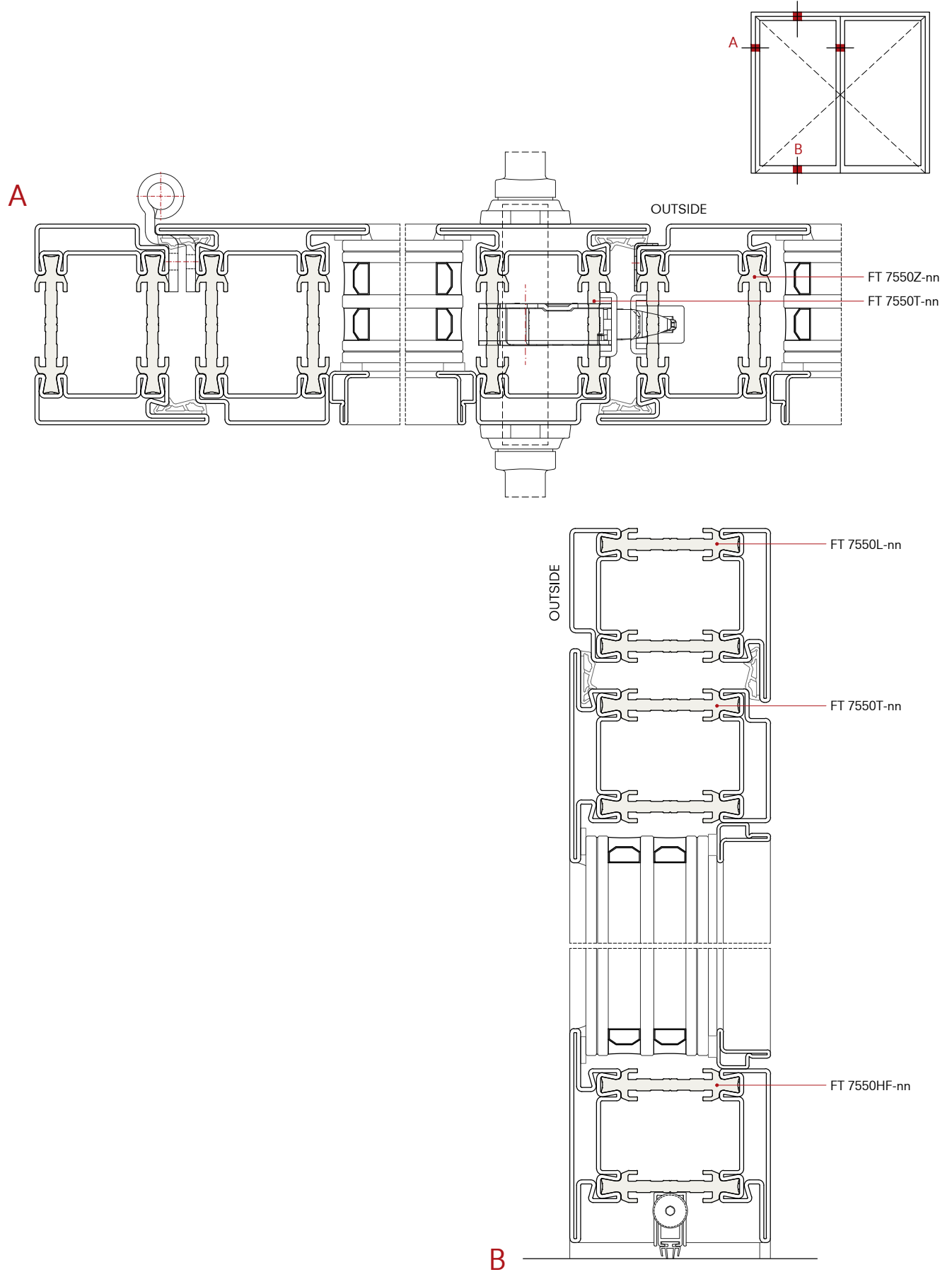

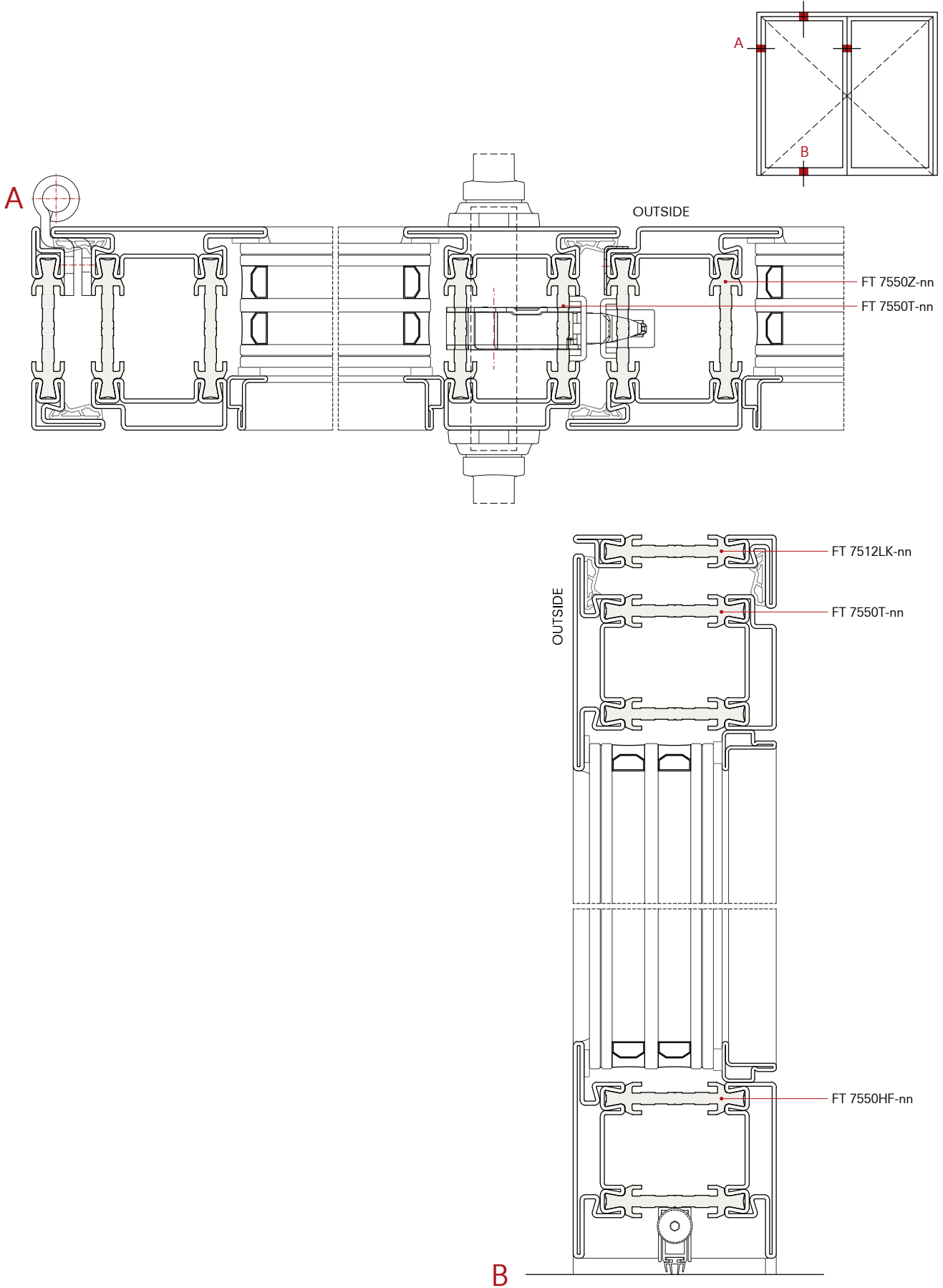

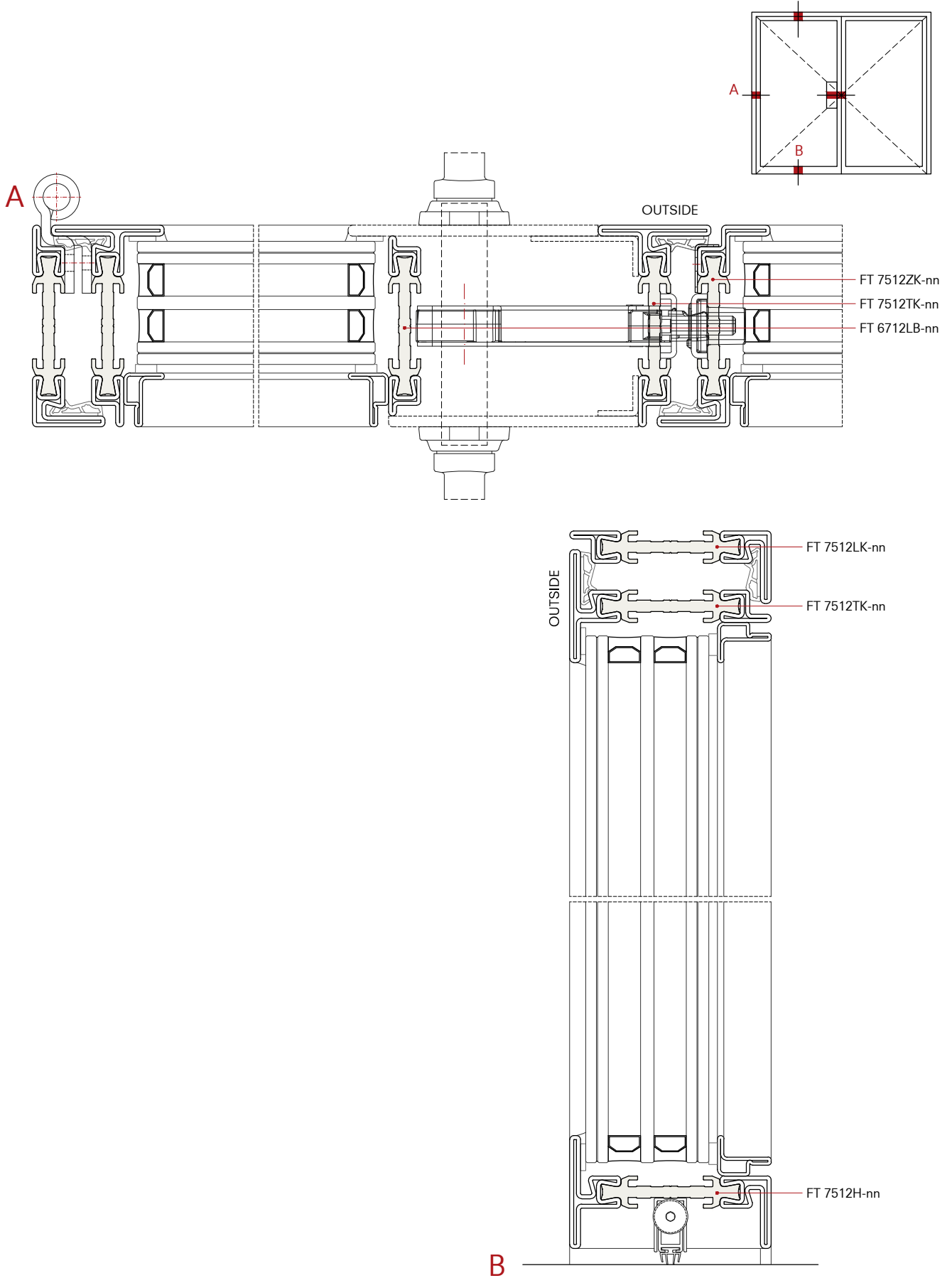

**Details, structural
connections**

Details Konstruktion

Détails de construction

4.3

Legend

+ = Fixed
— = Open in
- - - = Open out
Dimensions in: mm
Scale 1:1

Legende

+ = Fixed
— = Innen öffnend
- - - = Außen öffnend
Einheit in: mm
Maßstab 1:1

Légende

+ = Fixe
— = Ouvr. intérieur
- - - = Ouvr. extérieur
Dimensions en: mm
Échelle 1:1

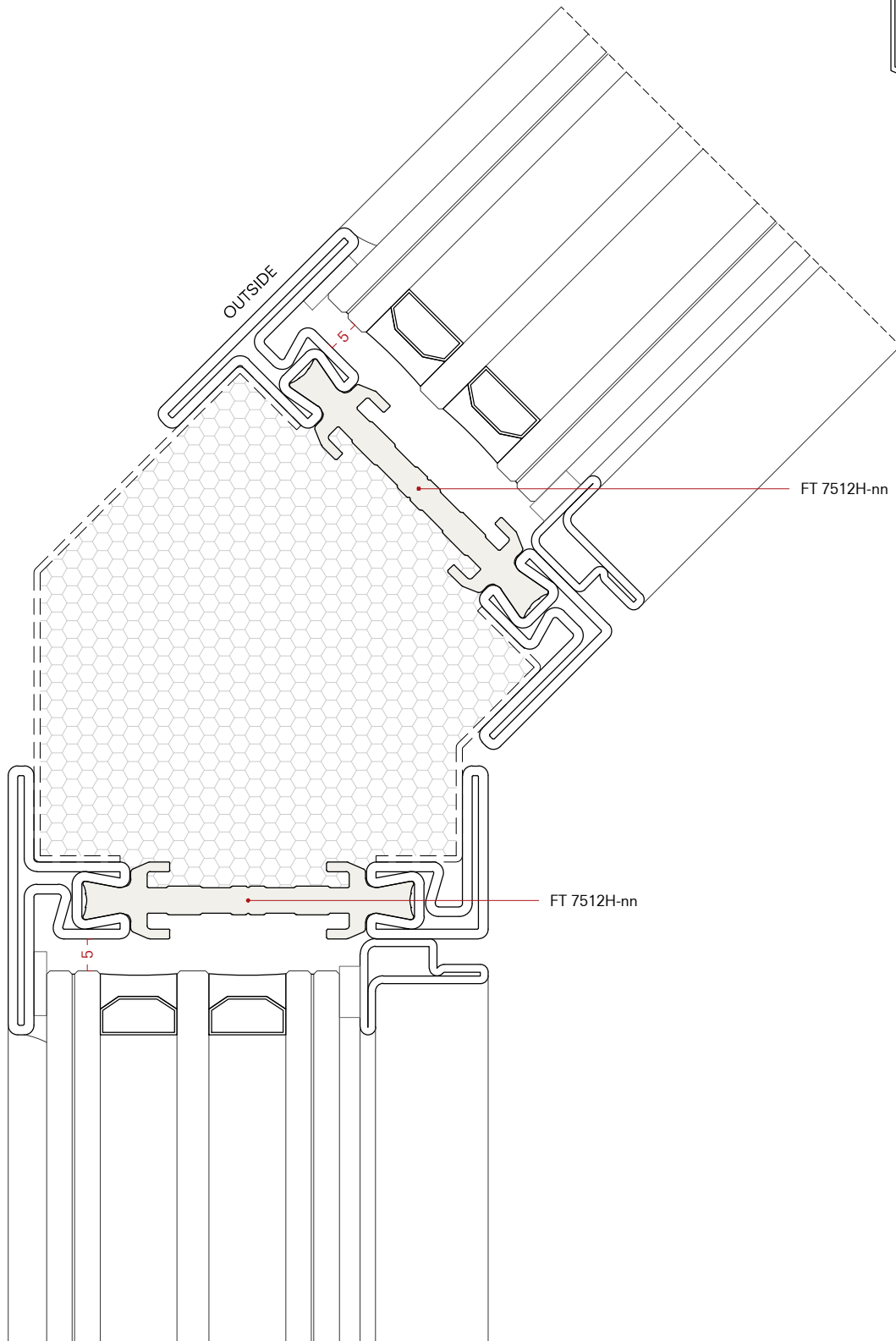
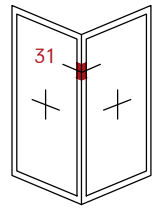

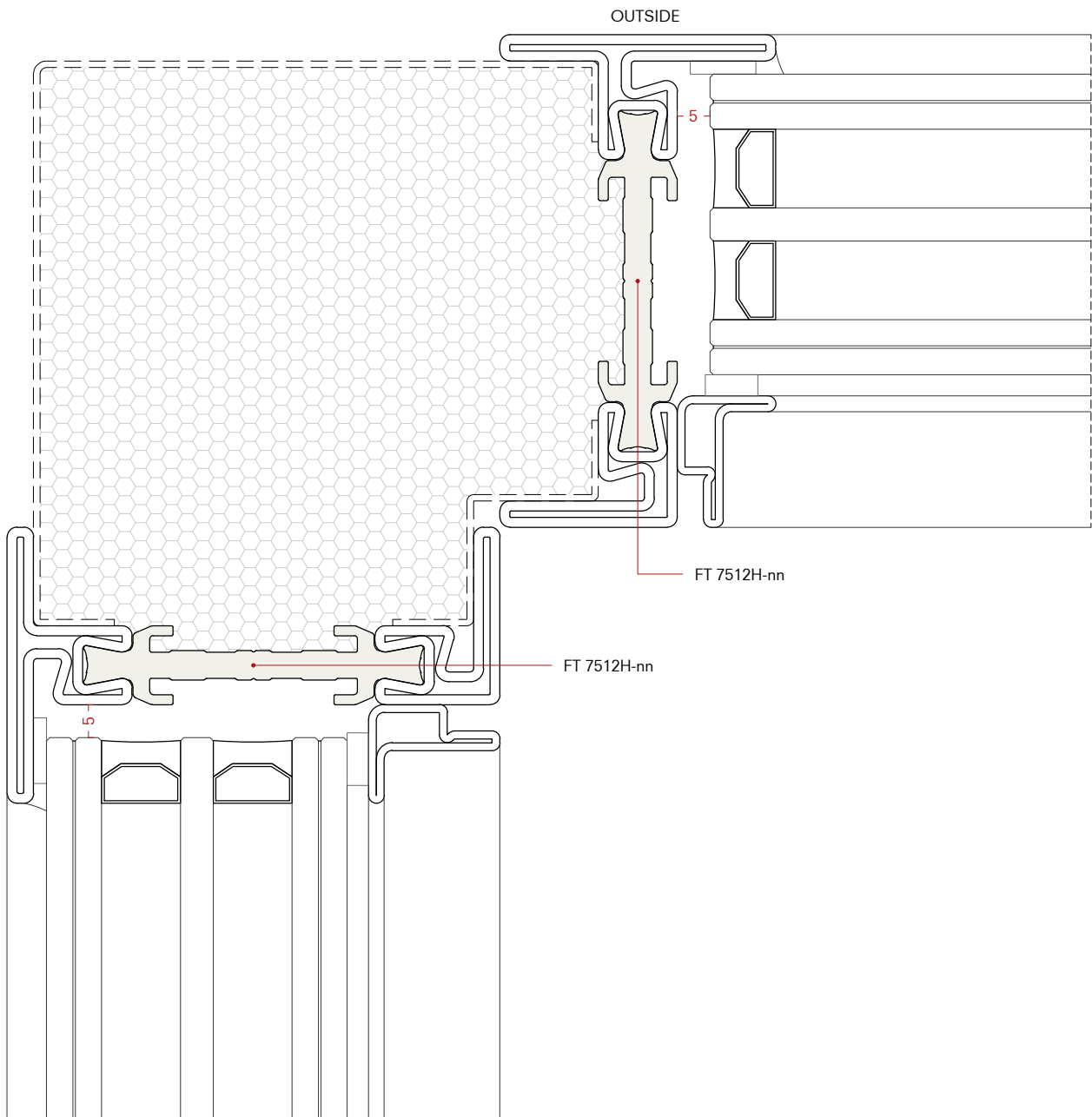
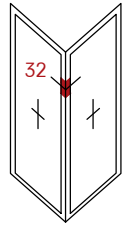

Wall connections

Bauanschlüsse

Détails de raccords au mur

4.4

Legend

+ = Fixed
— = Open in
- - - = Open out
Dimensions in: mm
Scale 1:2

Legende

+ = Fixed
— = Innen öffnend
- - - = Außen öffnend
Einheit in: mm
Maßstab 1:2

Légende

+ = Fixe
— = Ouvr. intérieur
- - - = Ouvr. extérieur
Dimensions en: mm
Échelle 1:2

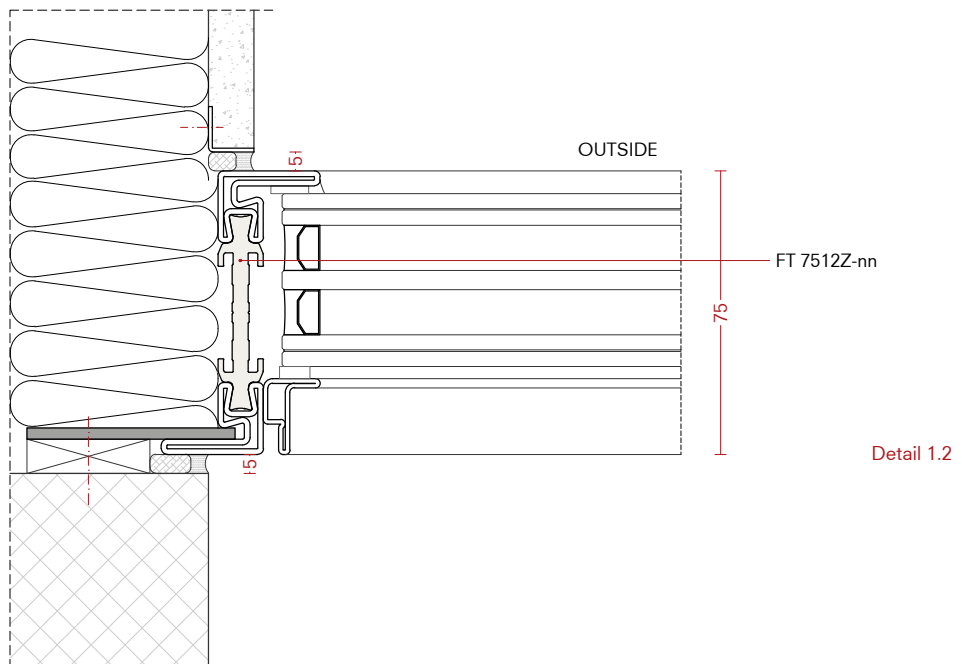
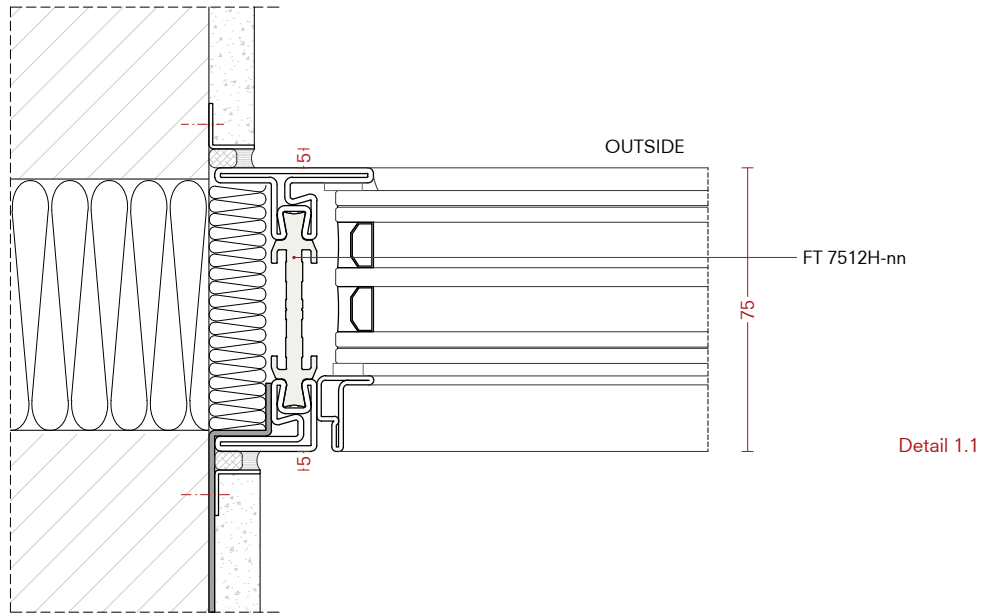

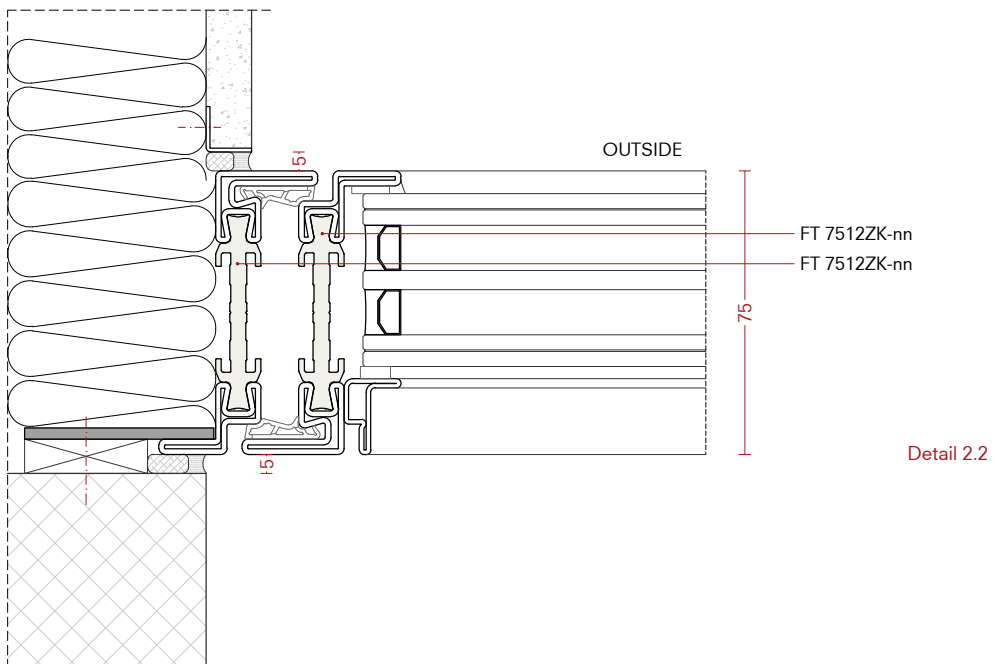
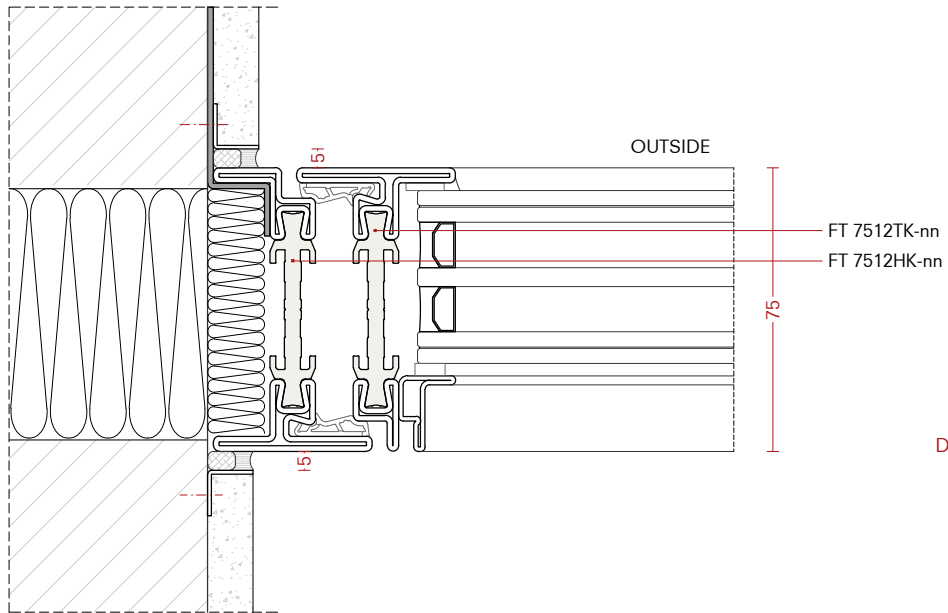

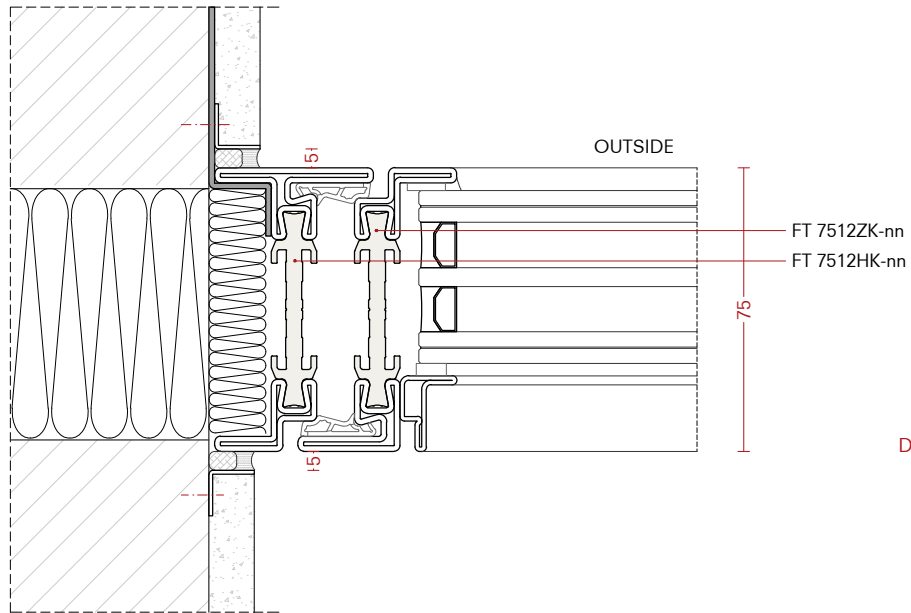

Detail 3.1

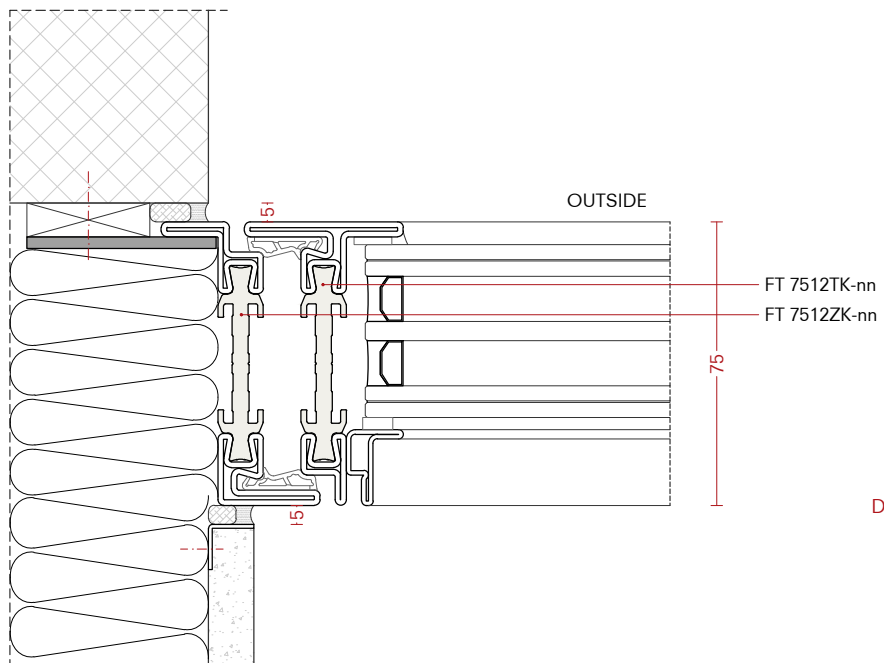

Detail 3.2

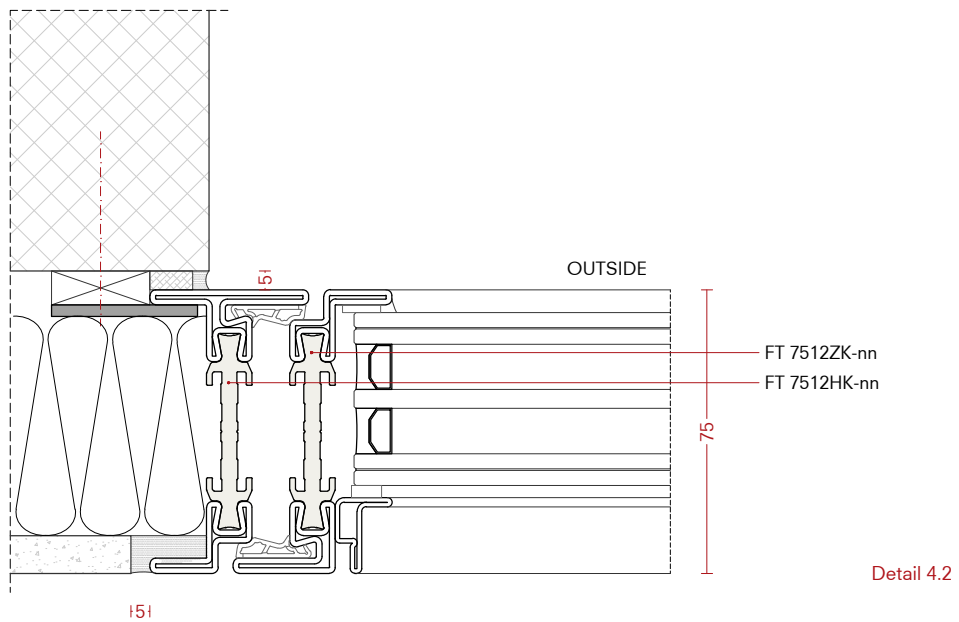
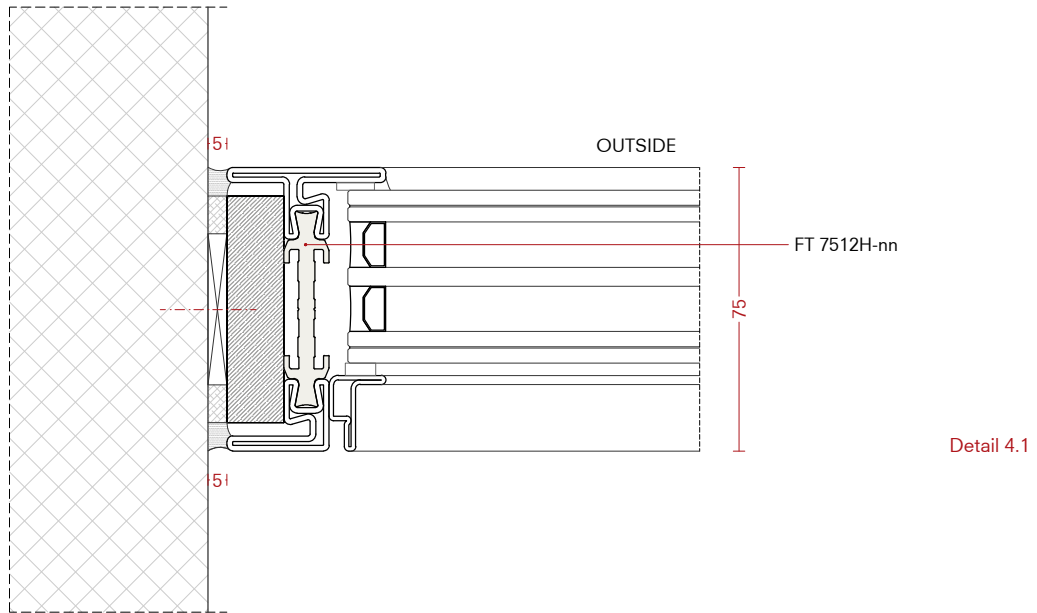

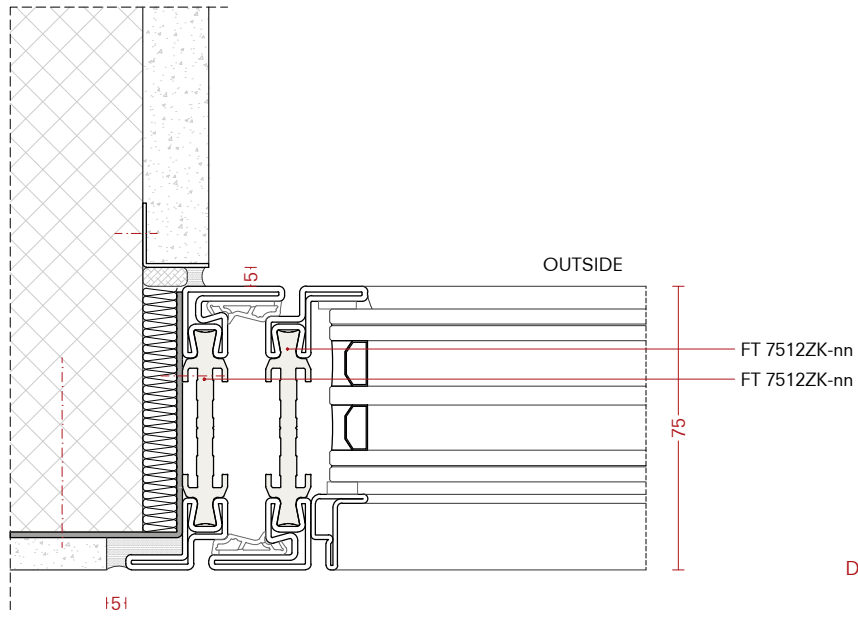

Detail 5.1

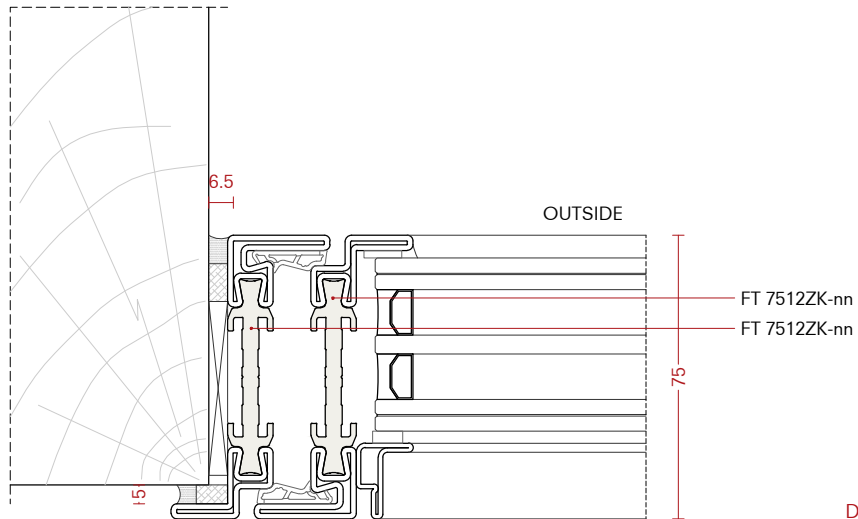

Detail 5.2

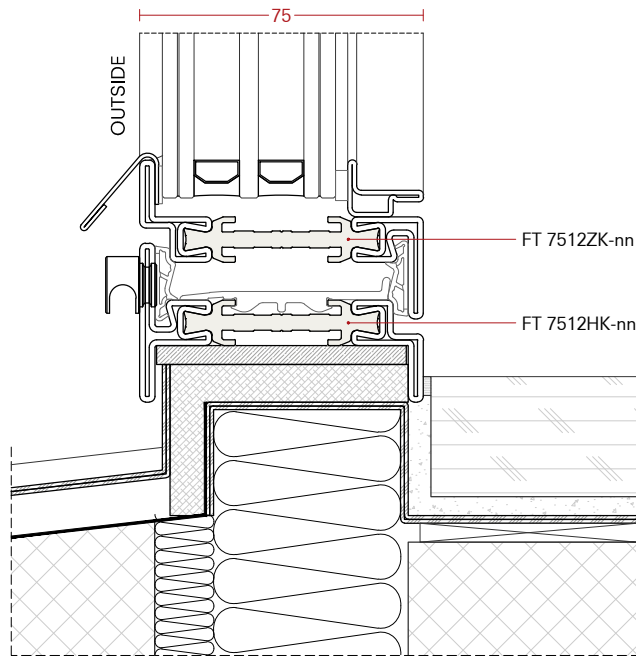

Detail 6.1

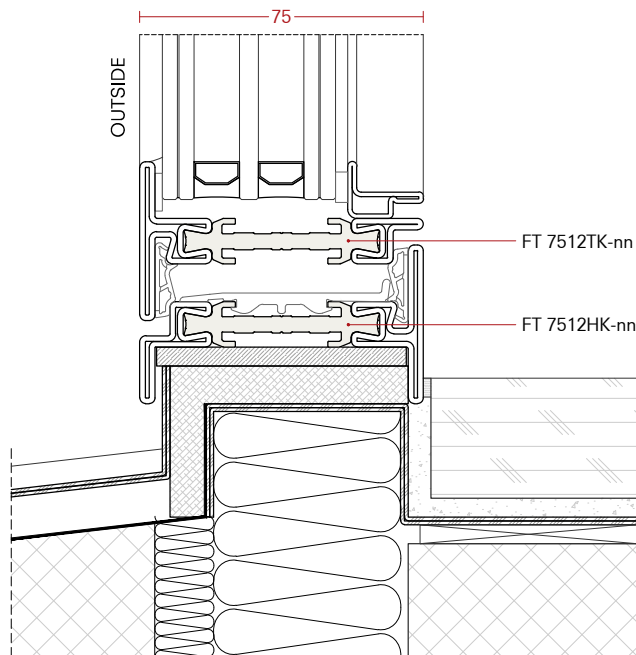

Detail 6.2

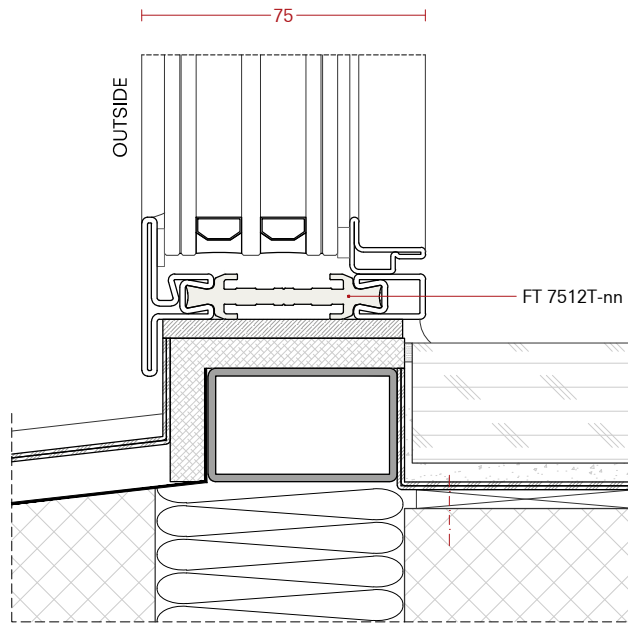

Detail 7.1

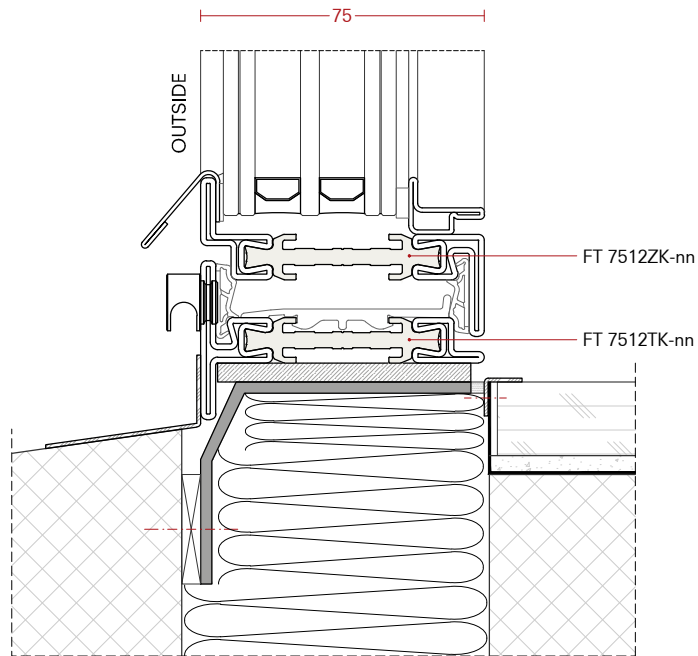

Detail 7.2

METALFORM

MASTERS OF METAL

UNITED KINGDOM

METALFORM

NORWAYMETAL LTD

53 Chelsea Manor Street

London, SW3 5RZ

SALES@METALFORM.UK

+44 20 81298814

GERMANY

METALFORM GMBH

Carl-Zeiss-Ring 15A

85737 Ismaning

SALES@METALFORMGROUP.DE

+49 17663630406

NORWAY

METALFORM AS

Brochmannsveien 2

1950 Rømskog

SALG@METALFORM.NO

+47 401 62 446

METALFORMGROUP

SALES@METALFORMGROUP.COM