

OS2
40

disegnare le
 trasparenze
drawing the
 transparencies

METALFORM





OS2 40 + OS2 75

METALFORM

OS2 40

La massima qualità in un sistema ridotto all'essenziale. Studiati per i progetti di interior design, i profili tubolari, agili e leggeri, riproducono nelle partizioni vetrate la stessa immagine dei serramenti OS2 a taglio termico, creando un effetto di continuità fra interno ed esterno dell'edificio.

The maximum quality in a system reduced to the essentials: OS2 40. Designed for interior design projects, the agile and lightweight tubular profiles reproduce the same image of the OS2 windows and doors in the glass partitions, creating an effect of continuity between interiors and the building envelope.

METALFORM



porta scorrevole con vetri singoli
sliding door with single glass

METALFORM



porta due ante
double sashes door

METALFORM



METALFORM



METALFORM



porta ad un'anta
single sash door

METALFORM



porta a due ante
double sashes door

METALFORM

OS2 40

sezioni a vista da 12 a 47 mm,
profondità di soli 42 mm e vetri
fino a 27 mm.

the visible sections range from
12 to 47 mm while the depth is
reduced to 42 mm, for glazing
up to 27 mm.

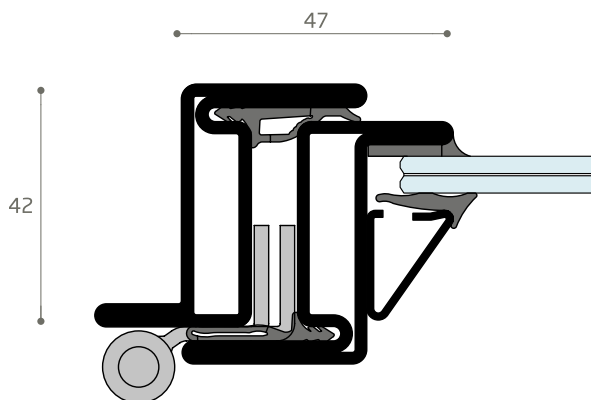

METALFORM

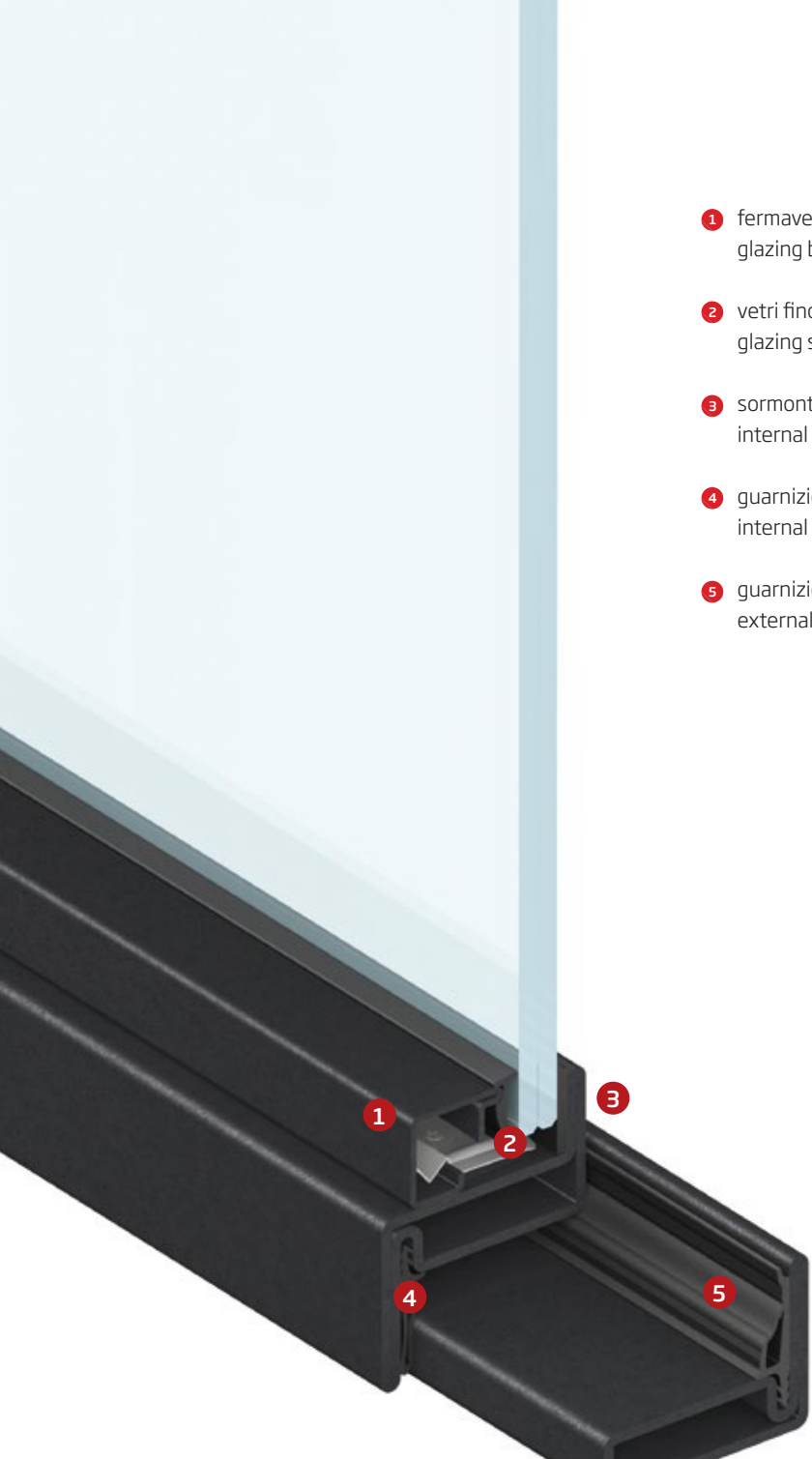

- 1 fermavetro
glazing bead
- 2 vetri fino a 27 mm
glazing slot up to 27 mm
- 3 sormonto interno ed esterno
internal and external overlap
- 4 guarnizione di battuta interna
internal rebate gasket
- 5 guarnizione di battuta esterna
external rebate gasket

METALFORM

OS2 40

tipologie di apertura porte
openings doors

apertura interna
inward opening

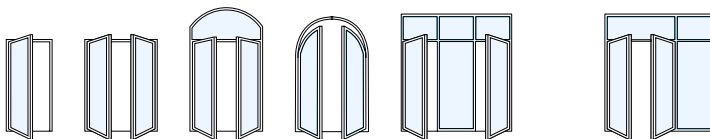

apertura esterna
outward opening

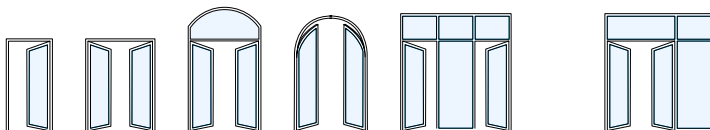

materiali
materials

acciaio decapato
(verniciato)
pickled steel
(painted)



METALFORM

maniglie
handles

VITRUVIO tronca

finiture
finishes

ottone naturale | brunito | verniciato
natural brass | burnished | painted

Corten
Cor-ten



VITRUVIO quadra

finiture
finishes

ottone naturale | brunito | verniciato
natural brass | burnished | painted

Corten
Cor-ten



METALFORM



OS2 40 vista esterna | external view

METALFORM



OS2 40 vista interna | internal view

METALFORM

OS2 40

nodi sections

apertura interna
inward opening

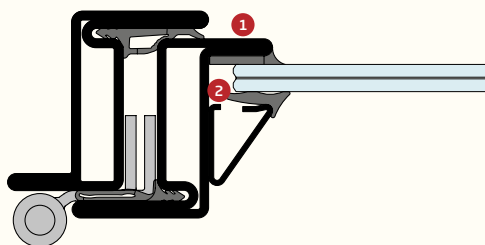

- 1 sormonto interno ed esterno
internal and external overlap
- 2 camera per vetri fino a 27 mm
fitting groove up to 27 mm

apertura esterna
outward opening

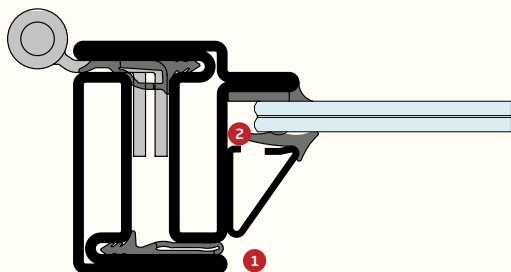

- 1 sormonto interno ed esterno
internal and external overlap
- 2 camera per vetri fino a 27 mm
fitting groove up to 27 mm

METALFORM

profili
profiles

PR2424



PR2425

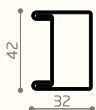

PR2430



PR2431



PR2451

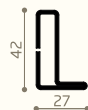

PR2461

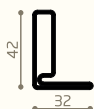

PR2462

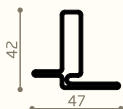

PR2463

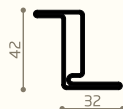

PR2464



PR2471



PR2454

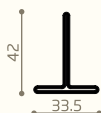

PR2455

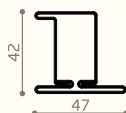

PR2474

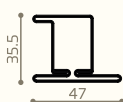

PR2482

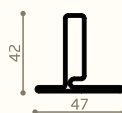

fermavetri
glazing beads

PR2415



PR2416



PR2429



PR2606



PR2607



METALFORM

OS2 40

sezioni
sections

apertura interna
inward opening

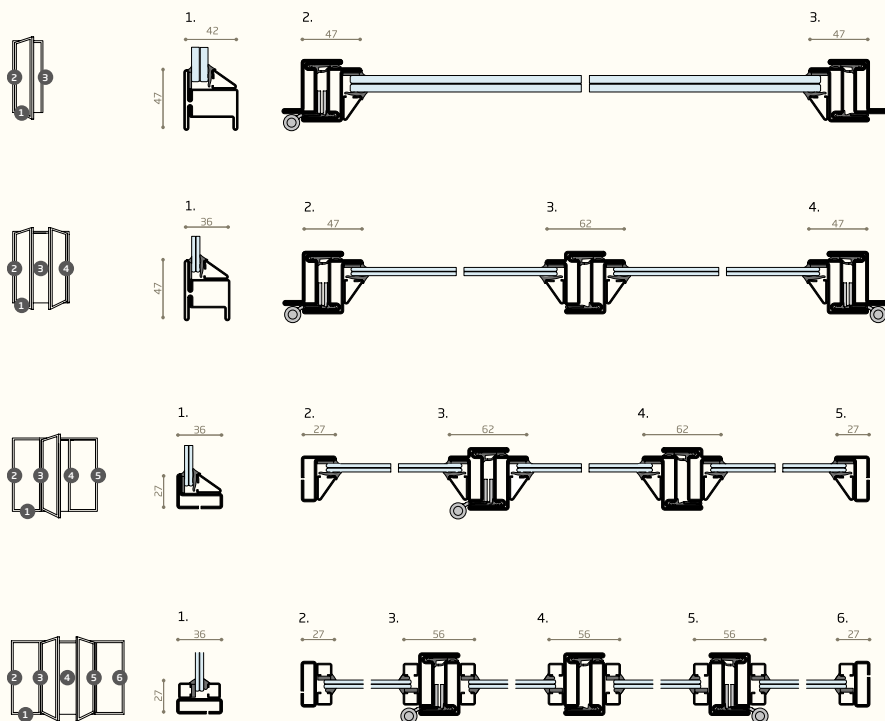

METALFORM

OS2 40

sezioni
sections

apertura esterna
outward opening

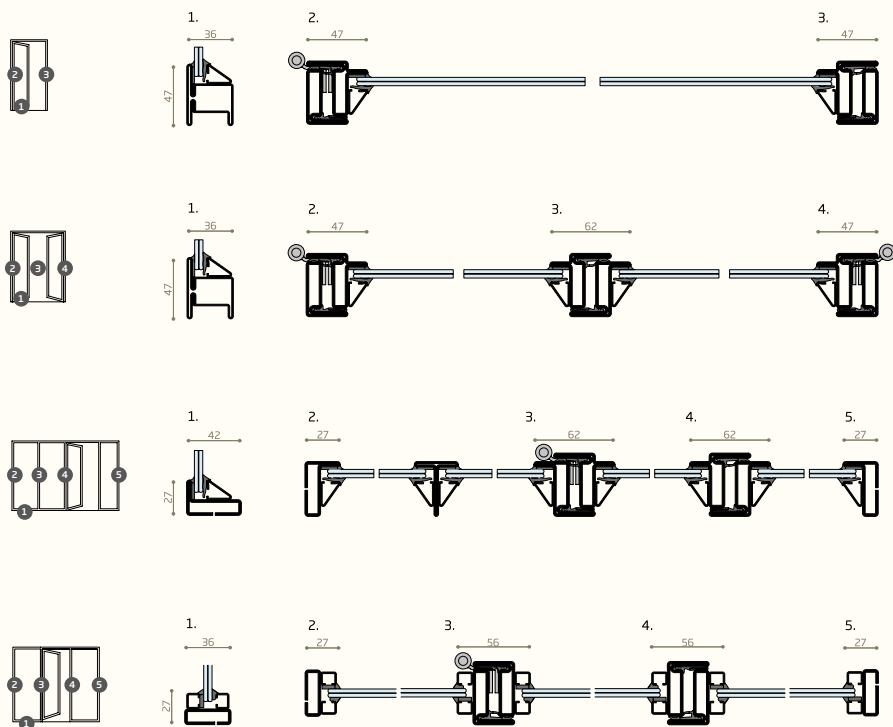

METALFORM







porta ad un'anta con fissi
single sash door with fixed pane



fisso con dividivetro
fix door with divide profile

METALFORM

METALFORM

MASTERS OF METAL

UNITED KINGDOM

METALFORM

NORWAYMETAL LTD

53 Chelsea Manor Street

London, SW3 5RZ

SALES@METALFORM.UK

+44 20 81298814

GERMANY

METALFORM GMBH

Carl-Zeiss-Ring 15A

85737 Ismaning

SALES@METALFORMGROUP.DE

+49 17663630406

NORWAY

METALFORM AS

Brochmannsveien 2

1950 Rømskog

SALG@METALFORM.NO

+47 401 62 446

METALFORMGROUP

SALES@METALFORMGROUP.COM