

METALFORM

rp technik 



rp hermetic

Fenster, Türen und Trennwände aus
Stahl für hohe Leistungsanforderungen,
Brand- und Rauchschutz

Windows, doors and partition walls
made of steel for high performance
requirements, fire and smoke protection

METALFORM



Die Freiheit der Architektur

Freedom of architecture

Unser Anspruch ist höchste Qualität. Seit mehr als 60 Jahren entwickeln und produzieren wir Stahlsysteme für Fenster, Türen und Fassaden – mit handwerklichem Geschick und einer Menge Know-how. Bei unseren Produktlösungen setzen wir auf den vielseitigen Werkstoff Stahl und verbinden auf diese Weise ansprechende Ästhetik mit höchster Belastbarkeit. Sowohl Planung als auch Metallbau profitieren von unserer jahrzehntelangen Erfahrung – und erhalten neben überzeugender Qualität einen maximalen gestalterischen Freiraum. Oder wie wir es nennen:

Die Freiheit der Architektur.

Our goal is top quality. We have been developing and producing steel systems for windows, doors and facades for more than 60 years - with craftsmanship and a great deal of know-how. In our product solutions we rely on the versatile material steel and in this way combine appealing aesthetics with maximum resilience. Both planners and metal manufacturers benefit from our decades of experience – and, in addition to convincing quality, are given a maximum in design freedom. Or as we call it:

Freedom of architecture.

METALFORM

© Fotodesign Andreas Braun, Hameln



100% funktional functional

rp hermetic – durchdachte Lösungen aus Stahl für anspruchsvolle Anwendungen

rp hermetic – das flexible Stahlsystem für Fenster, Türen und Trennwände. Hochfunktional, robust und zuverlässig. Im Brandschutz punktet das smarte Baukastensystem mit optisch identischen Profilen für verschiedene Brand- und Rauschutzklassen, sodass Projekte ohne optische Brüche „wie aus einem Guss“ realisiert werden können. Selbstverständlich erfüllt rp hermetic auch höchste Anforderungen hinsichtlich Schallschutz, Einbruchshemmung oder Durchschusshemmung.

Sie stellen die Anforderung – rp hermetic bietet die Lösung. Mit Sicherheit.

rp hermetic – clever solutions in steel for demanding applications

rp hermetic – the flexible steel system for windows, doors and partition walls. Highly functional, absolutely precise and reliable. In fire protection, the smart modular system scores points with its visually identical profiles for different fire and noise protection classes, allowing projects to be realised “as if from a single mould” without visual breaks. Of course, rp hermetic also meets the highest demands in terms of sound insulation, burglar resistance or bullet resistance, which can be individually planned and implemented.

You name your requirements – rp hermetic offers the solution. Reliably.

Mechanische Festigkeit
Mechanical strength

bis
up to

Klasse/class 4

Dauerfunktionsprüfung
Continuous performance test

bis zu
up to

1 Mio. Zyklen/cycles

Schwerlastbänder
Heavy duty hinges

bis
up to

400 kg

Schlagregendichtheit
Watertightness

bis
up to

Klasse/class E1050

Stoßfestigkeit
Impact strength

bis
up to

E5/I5

Schallschutz
Sound insulation

≤ 49 dB

Widerstandsfähigkeit gegen Windlast
Resistance under wind load

bis
up to

C4

Rauchschutztüren
Smoke protection doors

RS-1 / RS-2 / S_a / S₂₀₀



Einbruchhemmung
Burglar resistance

bis
up to

RC3

Durchschusshemmung
Bullet resistance

bis
up to

FB6

Brandschutz
Fire protection

bis
up to

EI120 / EW120 / E180

100%
Performance
performance

100%
zuverlässig
reliable

rp hermetic – zuverlässige
Stahlsysteme für hohe
mechanische Beanspruchung

rp hermetic – reliable steel
systems for high mechanical
loads





transfer,
saarvas,
Orientalismus,
girti,

Sanskrit,
Philosophie,
Yoga,
devotion

INFORMATION

INFORMATION

INFORMATION

FORME
Lufldruck,
Vulkan,
so Wokung,
Austungemälde,
Hygrometer,
Chimborazo,
Tropen,
data.

INFORMATION

interior,
Übertragung,
Zassano

INFORMATION

hutton,
Sprachpolitik,
Tustag.

INFORMATION

Roballon,
Zabernauer,
Zingales,
Lindau

METALFORM

rp hermetic
Humboldt Forum, Berlin

Architekt / Architect:
Franco Stella



rp hermetic

METALFORM



rp hermetic – geprüfte
Stahlsysteme für anspruchsvolle
Architektur

rp hermetic – tested steel
systems for demanding
architecture

100%
Sicherheit
Safety



METALFORM



Ausführung „Josh“, schwarz matt
Model „Josh“, black matte



100%
griffig
in hand

Gestaltung ist eine Frage von Haltung, von ersten Eindrücken und langfristigen Beziehungen. Diesem Gedanken folgend, überzeugen die Design-Grifflinien von RP Technik durch eine puristische Erscheinung und ergonomische Handhabung. Als Schnittstelle zwischen Fenstern aus Stahl und den Menschen, die sie ergreifen.

Design is a question of attitude, of first impressions and long-term relationships. In accordance with this thought, RP Technik's design handle lines win people over with a purist look and ergonomic treatment. As an interface between windows made of steel and the people who use them.

METALFORM

METALFORM



Ausführung „Josh“, schwarz matt
Model „Josh“, black matte

Design-Fenstergriffe für verdeckt liegende Beschläge
Design window handles for concealed fittings

Josh



Edelstahl matt
Stainless steel
RF1931042



Schwarz matt
Black matte
RF1931044



Aluminium
RF1931040

abschließbar / lockable



Edelstahl matt
Stainless steel
RF1931043



Schwarz matt
Black matte
RF1931045



Aluminium
RF1931041

Bern



Edelstahl matt
Stainless steel
RF1931022



Schwarz matt
Black matte
RF1931024



Aluminium
RF1931020

abschließbar / lockable



Edelstahl matt
Stainless steel
RF1931023



Schwarz matt
Black matte
RF1931025



Aluminium
RF1931021

Highland



Edelstahl matt
Stainless steel
RF1931032



Schwarz matt
Black matte
RF1931034



Aluminium
RF1931030

abschließbar / lockable



Edelstahl matt
Stainless steel
RF1931033



Schwarz matt
Black matte
RF1931035



Aluminium
RF1931031

Essential Line

abschließbar / lockable



Edelstahl matt
Stainless steel
RF1931036



Edelstahl matt
Stainless steel
RF1931037

Weitere Varianten finden Sie online!
You can find more options online!



<https://rp-technik.link/handles>

Standard-Fenstergriffe für verdeckt liegende Beschläge Standard window handles for concealed fittings

Optional für Dreh- und Stulpflügel
Optional for side-hung and double-vent windows

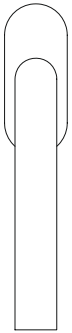

Edelstahl fein matt
Brushed stainless
steel matte
RX868400

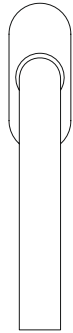

Aluminium
RX868671

abschließbar /
lockable

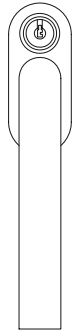

Edelstahl fein matt
Brushed stainless
steel matte
RX805344

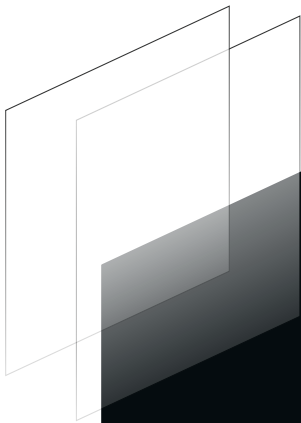

Ausführung „Highland“
Model „Highland“



Ausführung „Highland“,
abschließbar
Model „Highland“, lockable

Verantwortung für Generationen

Seit Beginn des 20. Jahrhunderts wird der Werkstoff Stahl für hochwertige Konstruktionen wie Stahlseile, Schienen und auch Bauelemente eingesetzt – und zwar immer wieder! Mit über einer halben Milliarde Tonnen ist Stahl heute der meistrecycelte Werkstoff der Welt!

100% langlebig:

Stahlfenster und -türen sind aufgrund ihrer Robustheit im Alltagsbetrieb nahezu unzerstörbar. Viele Stahlelemente von RP Technik sind seit über 50 Jahren in Gebäuden verbaut und funktionieren noch heute tadellos.

100% geschützt:

Durch die Zink-Magnesium Schmelztauchveredelung und robuste Pulverbeschichtung erhalten Stahlfenster, -türen und -fassaden von RP Technik einen schützenden Mantel, sodass Stahl seine konstruktiven Vorteile ohne Abstriche bei der Haltbarkeit gegenüber anderen Werkstoffen ausspielen kann.

100% recyclebar:

Stahl kann ohne jegliche Verluste recycelt werden und lässt sich unbegrenzt oft einschmelzen. Durch Stahlrecycling werden so jährlich allein in Deutschland mehr als 20 Mio. Tonnen CO₂ vermieden.

100% gut sortiert:

Durch seine Magnetfähigkeit lässt sich Stahl im Vergleich zu anderen Materialien sehr gut sortieren und erleichtert so das Recycling.

100% effizient:

Der hohe Elastizitätsmodul von Stahl ermöglicht einen geringeren Materialeinsatz und gleichzeitig filigrane Ansichtsbreiten.

rd.
approx.

50%

geringere CO₂-Emissionen less CO₂-emissions

... durch Multi-Recycling von Stahl über mehrere Lebenszyklen
... through multi-recycling of steel over several life cycles



© Adobe Stock

Responsibility for generations

Since the beginning of the 20th century, the material steel has been used for high-quality elements such as steel cables, rails and also building elements – again and again! With over half a million tons, steel is now the most recycled material in the world!

100% durable:

Due to their robustness, steel windows and doors are virtually indestructible in everyday use. Many RP Technik steel elements have been installed in buildings for over 50 years and still function flawlessly today.

100% protected:

The robust powder coating provides steel windows and doors with a protective coating, allowing steel to exploit its design advantages without compromising on durability compared to other materials.

100% recyclable:

Steel can be recycled without any losses and can be melted down an unlimited number of times. Steel recycling can save up to 20 million tonnes of annually.

100% well sorted:

Due to its magnetic properties, steel parts can be sorted and separated very easily compared to other materials.

100% efficient:

The highly elastic modulus of steel enables lower material usage and at the same time narrow face widths.

3 gute Gründe für Stahl

3 good reasons for steel

Hohe Ressourceneffizienz

Durch den hohen Elastizitätsmodul von Stahl lassen sich schlanke Profilgeometrien für Fenster-, Türen- und Fassadensysteme bei geringem Materialeinsatz realisieren.

High resource efficiency

The highly elastic modulus of steel allows slim profile geometries for window, door and façade systems to be realized with low material input.

Material Material	Elastizitätsmodul Elastic modulus	Auswirkung auf die Konstruktion Effect on construction
Stahl Steel	210.000	schlank slim
Aluminium Aluminium	70.000	
Holz Wood	10.000 N/mm ²	massig bulky

Langlebigkeit

In stark frequentierten Bereichen und bei hoher witterungsbedingter Beanspruchung überzeugen Stahlelemente durch ihre außergewöhnliche Robustheit.

Durability

In high-traffic areas and with high exposure to weather-related stress, steel elements demonstrate their exceptional robustness.

Aus der Praxis
From practice



3

METALFORM



Hohe Transparenz

Große Spannweiten bei geringen Ansichtsbreiten: Das ist Stahl.
So lassen sich großzügige Raster und mehr Durchblick verwirklichen.

High transparency

Large spans with small face widths: That's steel.
This makes it possible to realize large panes and more transparency.

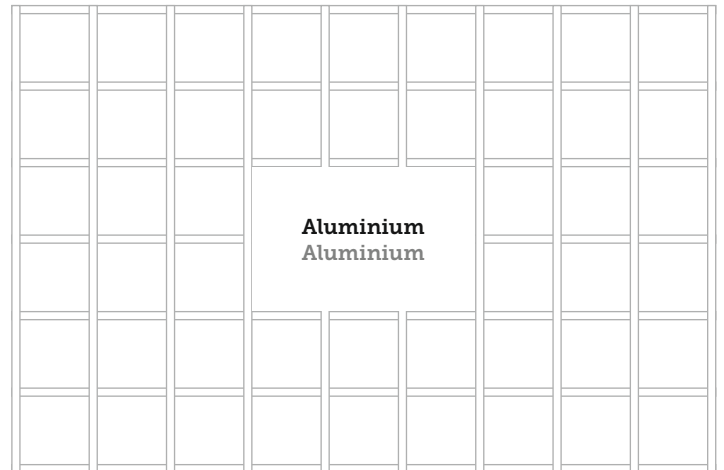
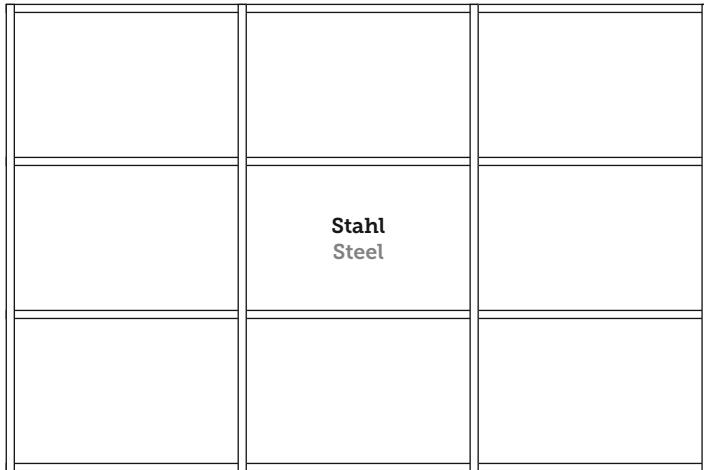

Das ist Stahl.
This is Steel.



METALFORM

„Allgäu Digital“, Kempten

Architekt / Architect:
Hermann Hagspiel, Kempten

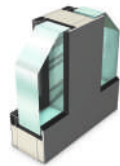
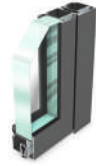

Überblick Overview	rp hermetic 70D	rp hermetic 70W	rp hermetic 55D	rp hermetic 55W
	ab Seite / from page 32	ab Seite / from page 40	ab Seite / from page 50	ab Seite / from page 56
				
Tür / Door	✓		✓	
Fenster / Window		✓		✓
Trennwände / Festverglasungen Partion walls / Fixed glazings	✓	✓	✓	✓
Wärmegeämmt Thermal insulation	ja / yes	ja / yes	nein / no	nein / no
Stahl / Steel	✓	✓	✓	✓
Edelstahl Stainless steel	✓	✓	✓	
Brandschutz Fire protection				
Rauchschutz Smoke protection				
Einbruchhemmung Burglar resistance	bis RC3 up to RC3	bis RC3 up to RC3	bis RC3 up to RC3	
Leistungseigenschaften / Performance characteristics				
Widerstandsfähigkeit gegen Windlast Resistance under wind load	bis C4 up to C4	bis C4 up to C4	bis C2 up to C2	
Luftdurchlässigkeit Air permeability	bis Klasse 4 up to class 4	bis Klasse 4 up to class 4	bis Klasse 2 up to class 2	
Schlagregendichtheit Watertightness	bis 7A (300 Pa) up to 7A (300 Pa)	bis Klasse E1050 up to class E1050	bis 4A up to 4A	
Stoßfestigkeit Impact strength	bis E5/I5 up to E5/I5	Klasse 1 Class 1		
Durchschusshemmung Bullet resistance	bis FB4 NS (mit Armierung/ Beplankung) up to FB4 NS (with armouring)	bis FB4 NS (mit Armierung) up to FB4 NS (with armouring)		
Wärmedurchgangskoeffizient Thermal transmittance	$U_f \geq 1,4 \text{ W/m}^2\text{K}$	$U_f \geq 1,7 \text{ W/m}^2\text{K}$ (Stahlfenster/ Steel windows)		
Schallschutz Sound insulation	$\leq 36 \text{ dB } (-2/-4)$	$\leq 49 \text{ dB } (-1/-4)$		
Fingerklemmschutz Finger trap protection	ja (optional) yes (optional)		ja (optional) yes (optional)	
Dauerfunktionsprüfung Continuous performance test	bis zu 1 Mio. Zyklen up to 1 Mio. cycles	bis Klasse 2, bis 10.000 Zyklen up to class 2, up to 10.000 cycles	200.000 Zyklen/cycles	
Dauerfunktionsprüfung; mechanische Beanspruchung Continuous performance test: mechanical stress	bis C7 (Fingerklemmschutz) up to C7 (Finger trap protection)	bis Klasse 2 up to class 2	bis C5 up to C5	
Fähigkeit zur Freigabe Ability to release	erfüllt fulfilled		erfüllt fulfilled	
Mechanisches Leistungsverhalten Mechanical performance	erfüllt fulfilled	erfüllt fulfilled		
Mechanische Festigkeit Mechanical strength	bis Klasse 4 up to class 4	bis Klasse 3 up to class 3	bis Klasse 4 up to class 4	

rp hermetic 55RS	rp hermetic 55FP-30/60/90/120/180	rp hermetic 70FP-30/60/90	rp hermetic 90FP-120	rp hermetic 75BR
ab Seite / from page 62	ab Seite / from page 66	ab Seite / from page 72	ab Seite / from page 88	ab Seite / from page 92
				
✓	✓	✓		✓
	✓	✓	✓	✓
nein / no	nein / no	ja / yes	ja / yes	nein / no
✓	✓	✓	✓	✓
	✓	✓	✓	
RS-1/RS-2 (national DE); S _a , S ₂₀₀ (europäisch geprüft / European tested)		RS-1/RS-2 (Türen/doors) (national DE); S _a , S ₂₀₀ (Türen/doors) (europäisch geprüft / European tested) bis RC3 up to RC3		
Weitere Details auf den Brand- und Rauchschutzseiten / Further details on the pages „fire and smoke protection“				
				FB4NS; FB6NS (mit Armierung / Beplankung) FB4NS; FB6NS (with armouring)
		≤ 44 dB (-1/-2) für Türen/for doors (30); ≤ 43 dB (0/-1) für Türen/for doors (60); ≤ 43 dB (90)		
200.000 Zyklen/cycles	200.000 Zyklen/cycles	bis zu 1 Mio. Zyklen up to 1 Mio. cycles		
bis C5 up to C5	bis C5 up to C5	bis C8 up to C8		
erfüllt fulfilled	erfüllt fulfilled	erfüllt fulfilled		
		erfüllt fulfilled		
		bis Klasse 4 (Türen) up to class 4 (doors)		

**Flexible Lösungen
für anspruchsvolle
Architektur**
Flexible solutions for
ambitious architecture

rp hermetic 70

METALFORM

Wärme gedämmtes Stahlsystem für Fenster, Türen und Trennwände

Thermally insulated steel system for windows, doors and partition walls

Systemübersicht

System overview

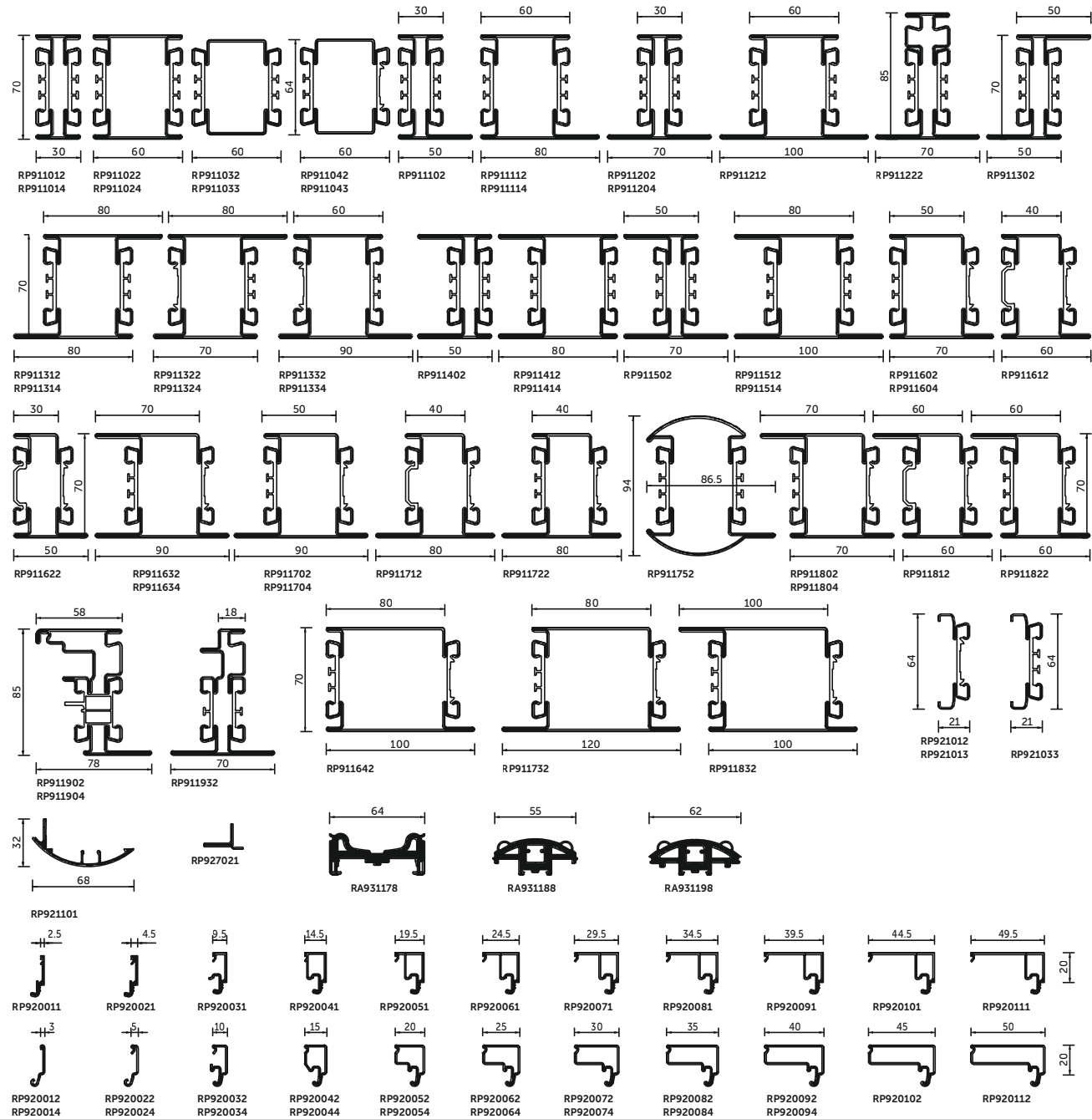

METALFORM

rp hermetic 70

Zentralbibliothek München
Central library, Munich



**ICH WAR EIN MEERESBUMMLER
UND DER OZEAN WAR MEIN
ZUHAUSE. HEUTE BIN ICH DEINS.
FÜR EINE NACHT, ZWEI ODER
DREI.**

rp hermetic 70D
METALFORM



MEERES
BUMMLER

cozycontainerliving

TITU 199 514
15 G

rp hermetic 70D

**Trennwände sowie ein- und zwei-
flügelige Türen aus Stahl und Edel-
stahl, wärmegeklämmt**

Steel and stainless steel profile system
for 1-leaf and 2-leaf doors and partition
walls, thermally insulated

METALFORM

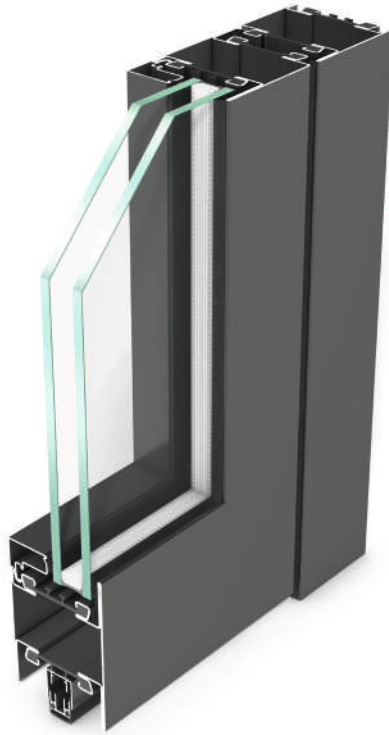

Ausführung als Tür
Model: Door

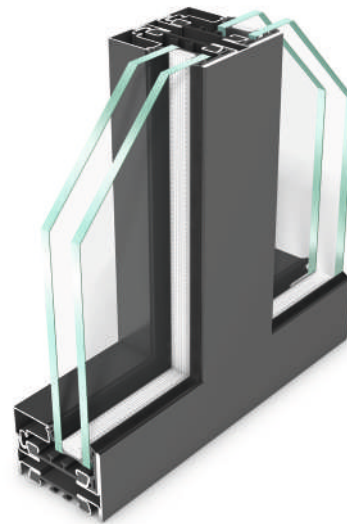

Ausführung als Trennwand
Model: Partition wall

Widerstandsfähigkeit gegen Windlast Resistance under wind load	bis C4 up to C4
Luftdurchlässigkeit Air permeability	bis Klasse 4 up to class 4
Schlagregendichtheit Watertightness	bis 7A (300 Pa) up to 7A (300 Pa)
Stoßfestigkeit Impact strength	bis E5/I5 up to E5/I5
Durchschusshemmung Bullet resistance	bis FB4 NS (mit Armierung/Beplankung) up to FB4 NS (with armouring)
Einbruchhemmung Burglar resistance	bis RC3 up to RC3
Wärmedurchgangskoeffizient Thermal transmittance	$U_t \geq 1,4 \text{ W/m}^2\text{K}$
Schallschutz Sound insulation	$\leq 36 \text{ dB } (-2/-4)$
Fingerklemmschutz Finger trap protection	ja (optional) yes (optional)
Dauerfunktionsprüfung Continuous performance test	bis C8, bis zu 1 Mio. Zyklen up to C8, up to 1 mio. cycles
Dauerfunktionsprüfung mechanische Beanspruchung Continuous performance test: mechanical stress	bis C7, bis zu 500.000 Zyklen (Fingerklemmschutz) up to C7, up to 500,000 cycles (Finger trap protection)
Fähigkeit zur Freigabe Ability to release	erfüllt fulfilled
Mechanisches Leistungsverhalten Mechanical performance	erfüllt fulfilled
Mechanische Festigkeit Mechanical strength	bis Klasse 4 up to class 4

rp hermetic 70D

Türen, nach innen öffnend

Doors, inward opening

METALFORM

Systemschnitte

Sections

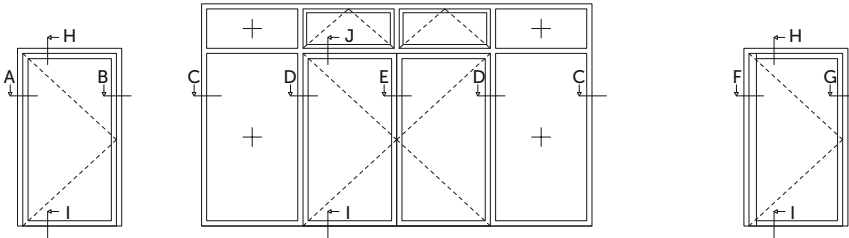

Anschlagtür, einflügelig
Single-action door,
single-leaf

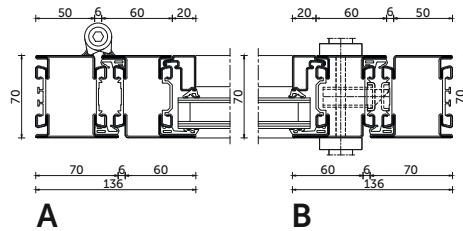

Anschlagtür, zweiflügelig
Single-action door,
double-leaf

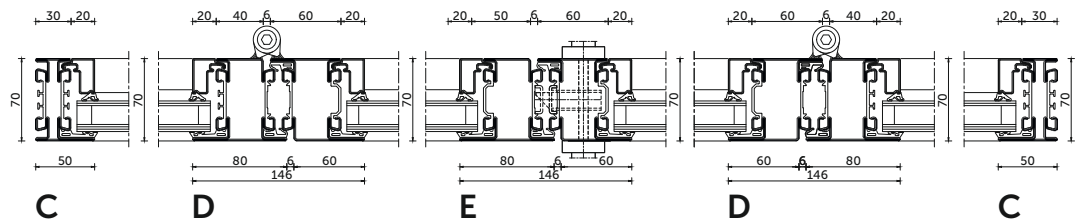

Anschlagtür mit
Fingerklemmschutz,
einflügelig
Single-action door
with anti-finger trap,
single-leaf

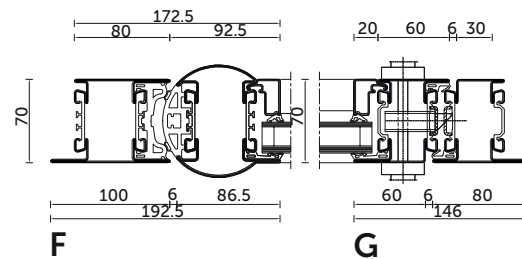

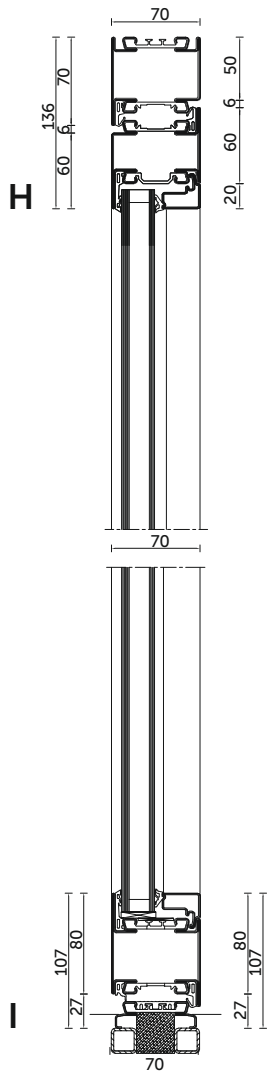

I
Anschlagtür nach innen öffnend
Single-action door, inward opening

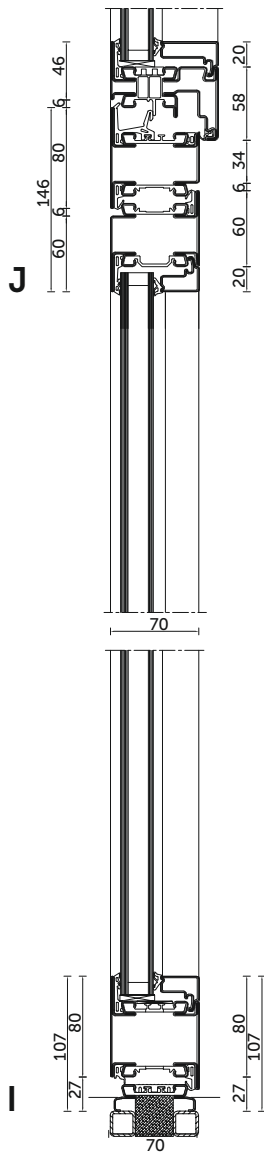

J
Anschlagtür mit Oberlicht
Single-action door with top light

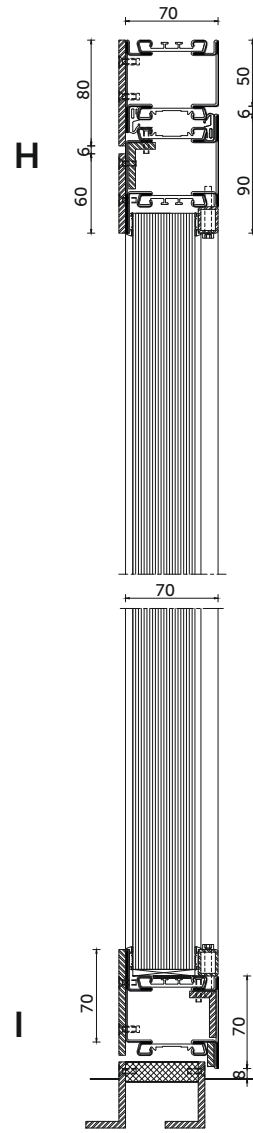

K
Anschlagtür mit Durchschusshemmung FB4 NS
Single-action door with FB4 NS bullet resistance

Türschwellen
Door thresholds

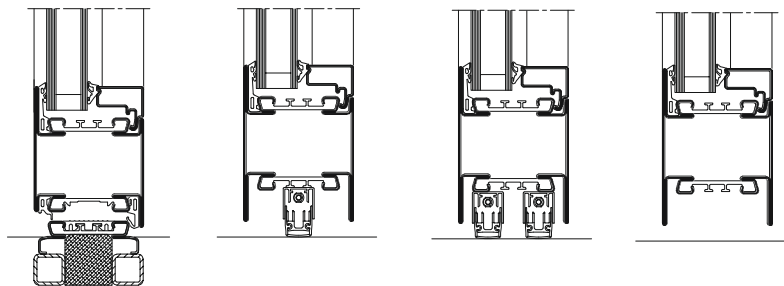

Türbänder-Varianten
Door hinge variants



rp hermetic 70D

Türen, nach außen öffnend

Doors, outward opening

METALFORM

Systemechnitte

Sections

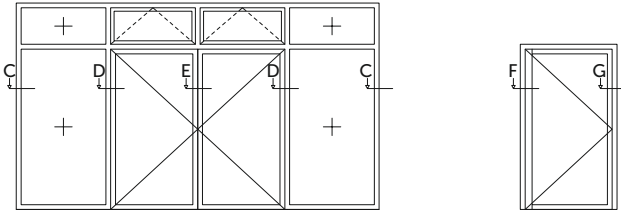

Anschlagtür,
zweiflügelig
Single-action door,
double-leaf

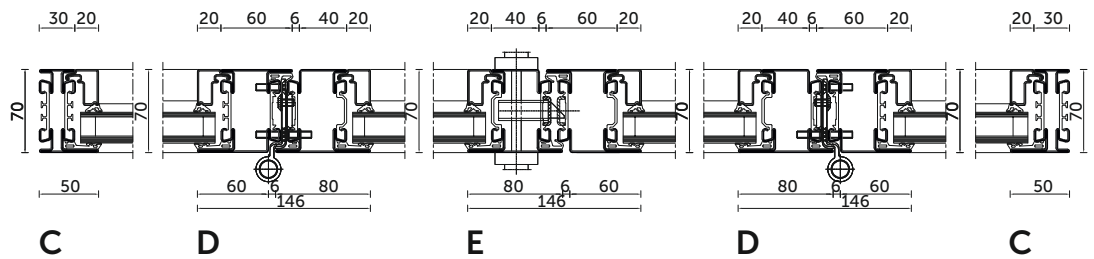

Ausführung mit
Elektro-Magnet
(Objektlösung)
Version with
electro-magnet
(project-specific
solution)

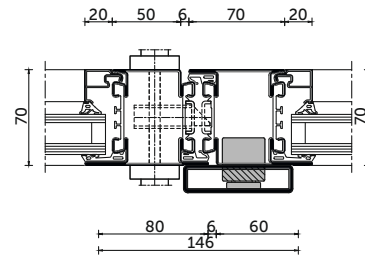

Anschlagtür mit
Fingerklemmschutz,
einflügelig
Single-action door
with anti-finger
trap, single-leaf

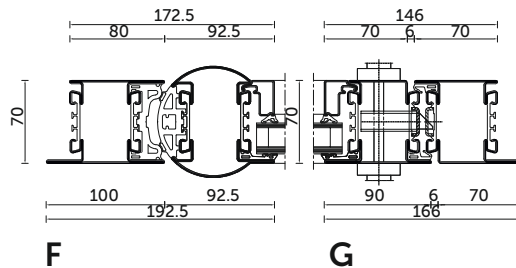

Komponenten zur
Erhöhung der
Wärmedämmung
Components to in-
crease thermal in-
sulation

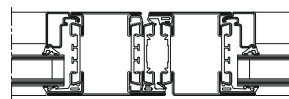

E

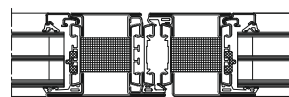
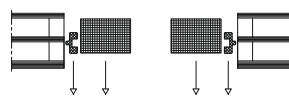

E

Anschlagtür,
einflügelig
Single-action
door, single-leaf

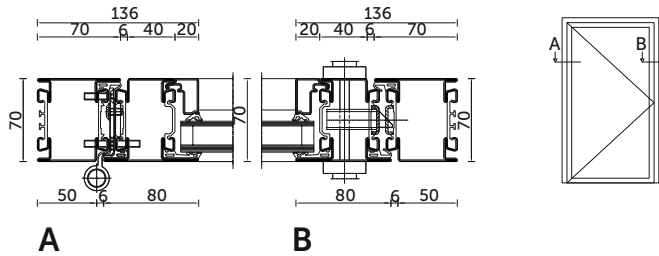

Ausführung mit
Elektro-Magnet
(Objektlösung)
Version with
electro-magnet
(project-specific
solution)

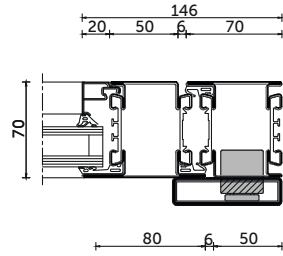

Fluentum, Berlin

Architekt / Architect:
Sauerbruch Hutton, Berlin

rp hermetic 70

METALFORM





rp hermetic 70
Hochschulbibliothek, München
University library, Munich

Architekt / Architect:
Prof. Andreas Meck, meck architekten,
Ottobrunn

rp hermetic 70W

Festverglasungen sowie ein- und zweiflügelige Fenster aus Stahl und Edelstahl, wärmege­dämmt

Steel and stainless steel system for 1-leaf and 2-leaf windows and fixed glazing, thermally insulated

METALFORM

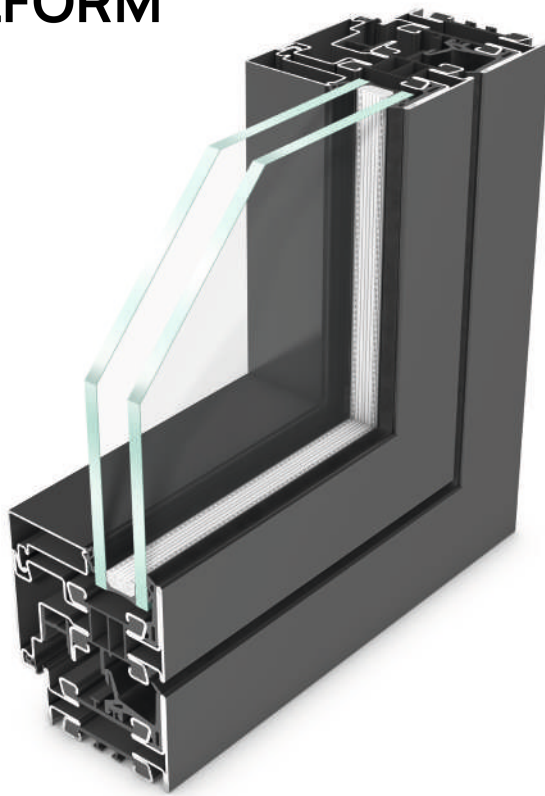

Ausführung als Fenster
Window example

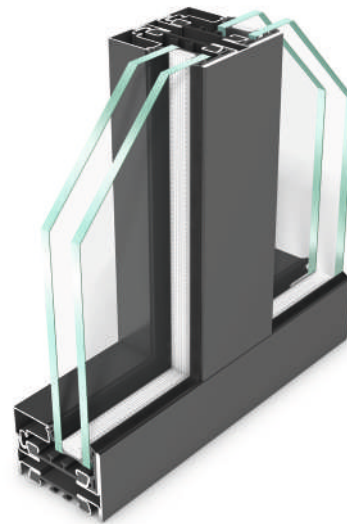

Ausführung als Festverglasung
Fixed glazing example

Widerstandsfähigkeit gegen Windlast Resistance under wind load	bis C4 up to C4
Luftdurchlässigkeit Air permeability	bis Klasse 4 up to class 4
Schlagregendichtheit Watertightness	bis Klasse E1050 up to class 7A (300 Pa)
Stoßfestigkeit Impact strength	Klasse 1 Class 1
Durchschusshemmung Bullet resistance	bis FB4 NS (mit Armierung) up to FB4 NS (with armouring)
Einbruchhemmung Burglar resistance	bis RC3 up to RC3
Wärmedurchgangskoeffizient Thermal transmittance	$U_i \geq 1,7 \text{ W/m}^2\text{K}$ (Stahlfenster / Windows)
Schallschutz Sound insulation	$\leq 49 \text{ dB}$
Dauerfunktionsprüfung mechanische Beanspruchung Continuous performance test: mechanical stress	bis Klasse 2 up to class 1
Bedienkräfte Operating forces	bis Klasse 1 up to class 1
Absturzsicherheit Fall protection barrier glazing	erfüllt (Festverglasungen) fulfilled (fixed glazings)
Mechanisches Leistungsverhalten Mechanical performance	erfüllt fulfilled
Mechanische Festigkeit Mechanical strength	bis Klasse 3 up to class 3

rp hermetic 70W

Fenster, nach innen öffnend

Window, inward opening

METALFORM

Systemechnitte

Sections

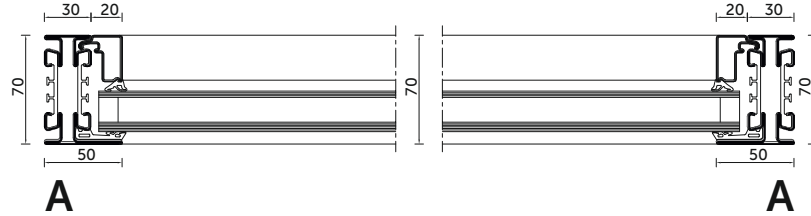
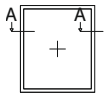

Festverglasung
Fixed glazing

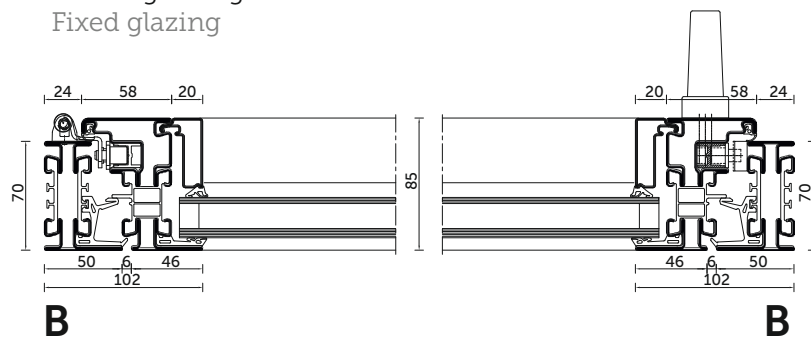
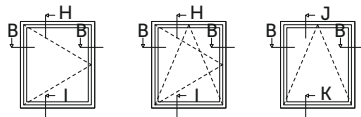

Fenster, einflügelig; diverse Beschlagvarianten möglich;
Dreh-Kipp, Kipp; hier dargestellt: Dreh
Window, single-leaf; various hardware variants possible;
turn-tilt, tilt; Turn option shown above

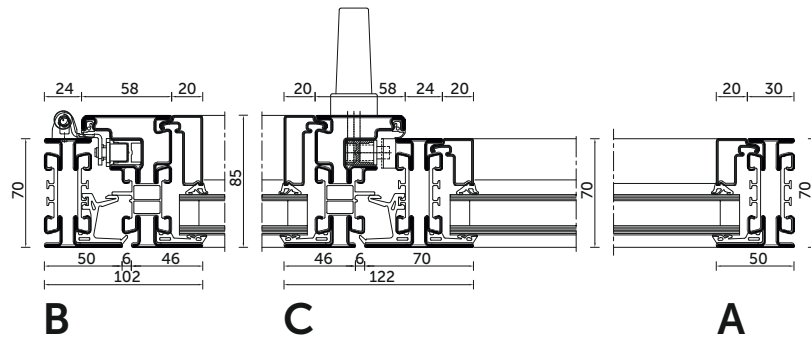
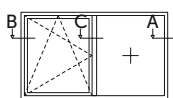

Fensterelement mit Seitenteil Dreh-Kipp / Festverglasung
Window element with side part turn-tilt / fixed glazing

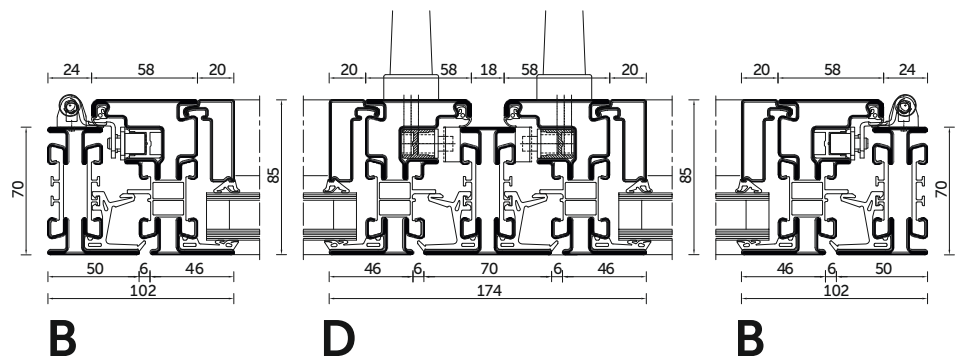
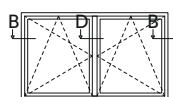
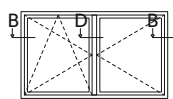

Fensterelement mit Mittelpfosten Dreh-Kipp / Dreh
Window element with centre mullion turn-tilt / turn

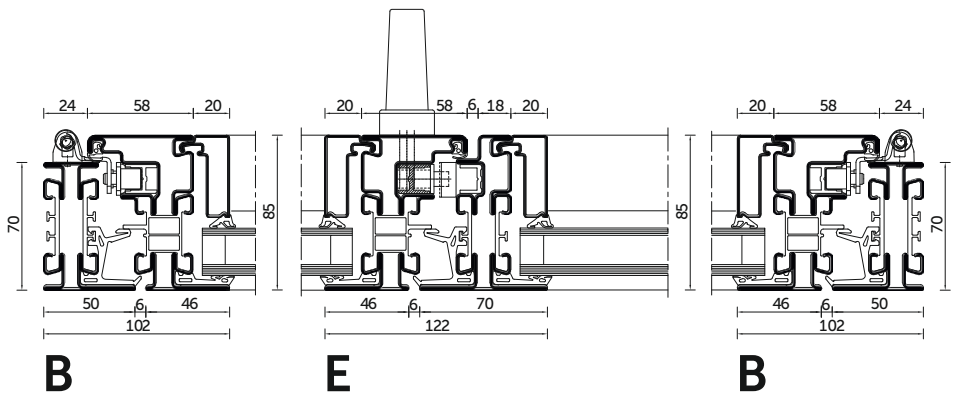
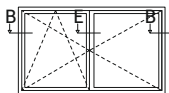

Fensterelement mit Stulpprofil Dreh-Kipp / Dreh
Window element with faceplate profile turn-tilt / turn

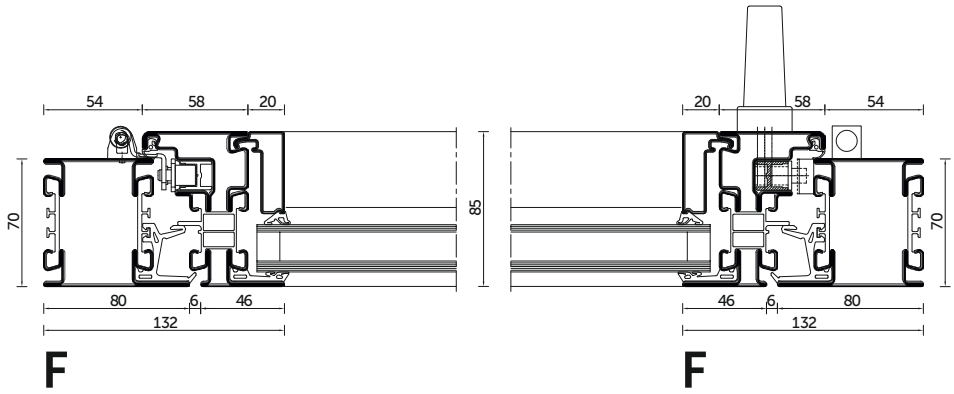
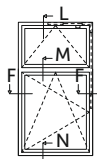

Fensterelement mit Oberlicht Dreh-Kipp / Kipp
Window element with top light turn-tilt / tilt

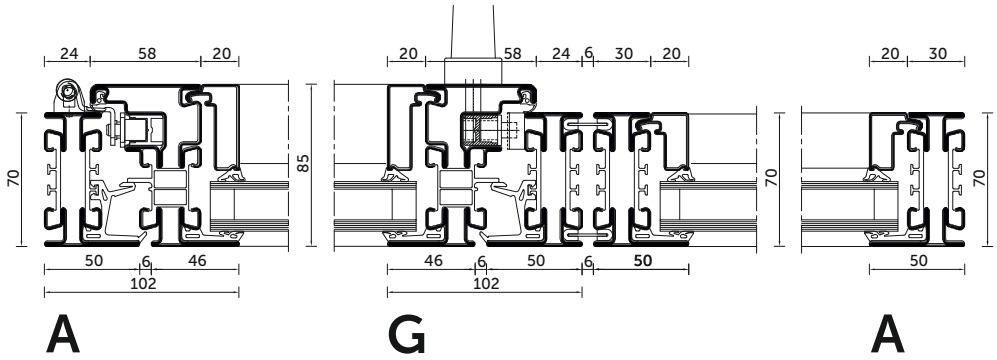
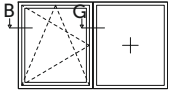

Elementierte Bauweise möglich, Elementkopplung,
Dreh-Kipp / Festverglasung
Individual frames can be coupled. Turn-tilt/fixed
glazing shown above.

rp hermetic 70W

Fenster, nach innen öffnend

Window, inward opening

METALFORM

Systemechnitte

Sections

Komponenten zur Erhöhung der Wärmedämmung

Components to increase thermal insulation

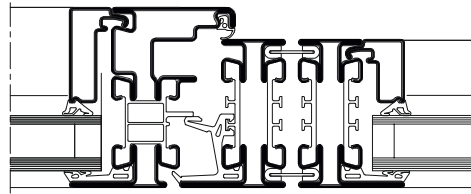

$$U_f = 2,4 \text{ W/m}^2\text{K}$$

G

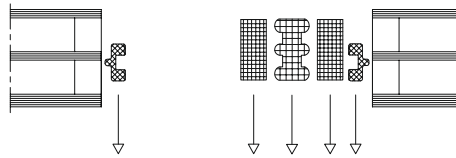

Zusatzmaßnahmen
Additional measures

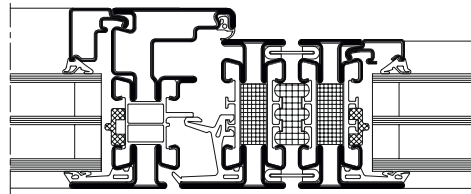

$$U_f = 1,7 \text{ W/m}^2\text{K}$$

G

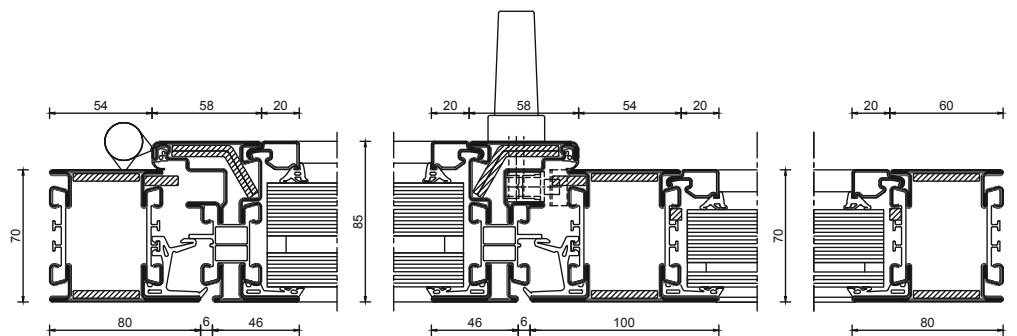
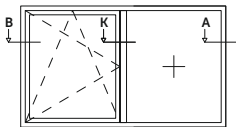

B

K

A

Fenster mit Durchschusshemmung FB4 NS

Windows with FB4 NS bullet resistance

METALFORM

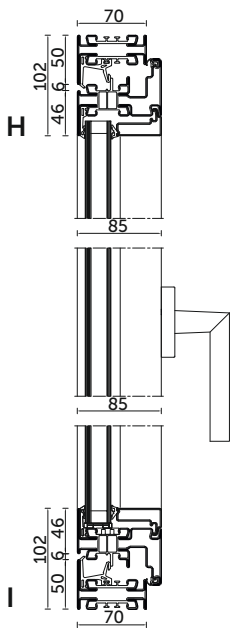
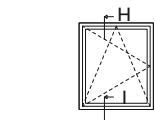

Fensterflügel mit Dreh- oder Dreh-Kipp-Beschlag
Window sash with turn or turn-tilt fitting

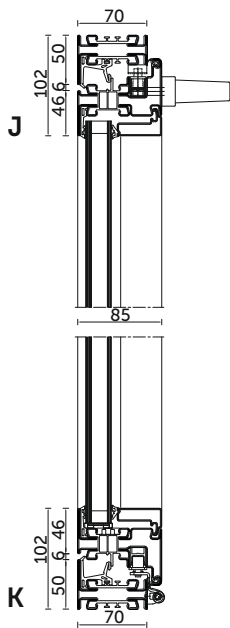
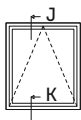

Fensterflügel mit Kipp-Beschlag
Window sash with tilt fitting

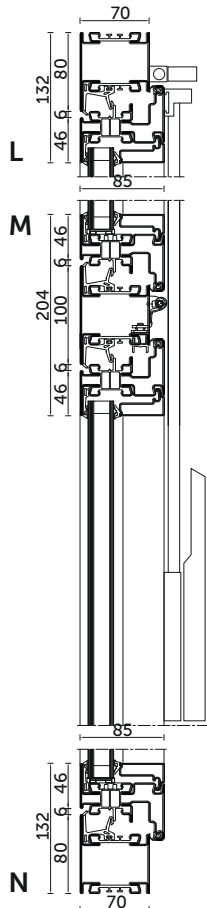
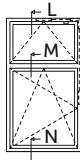

Dreh-Kipp / Kipp Fenster mit Oberlichtbeschlag Kipp
Turn-tilt / tilt window with top tilt fitting

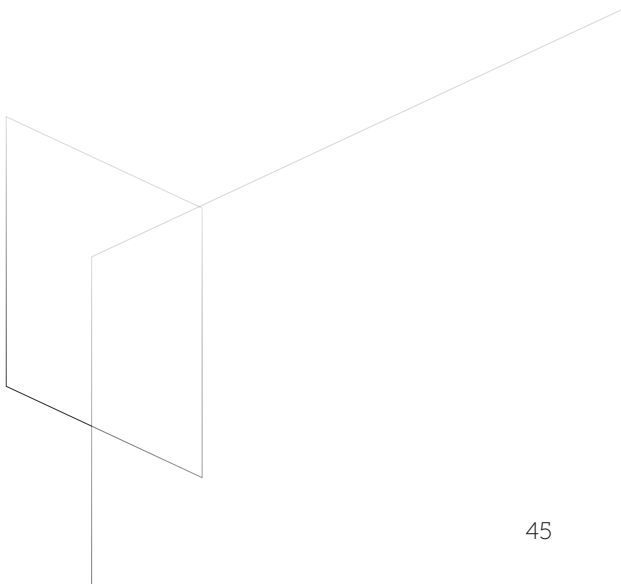

rp hermetic 70

Klappfenster nach außen öffnend,
motorisch betrieben, in Fassade eingespannt
Top-hung window, outward opening,
motor-driven, glazed into façade

Architekt / Architect:

v. Bassewitz Limbrock Partner, Hamburg

METALFORM

rp hermetic 70
CCH Hamburg

Systemübersicht
System overview

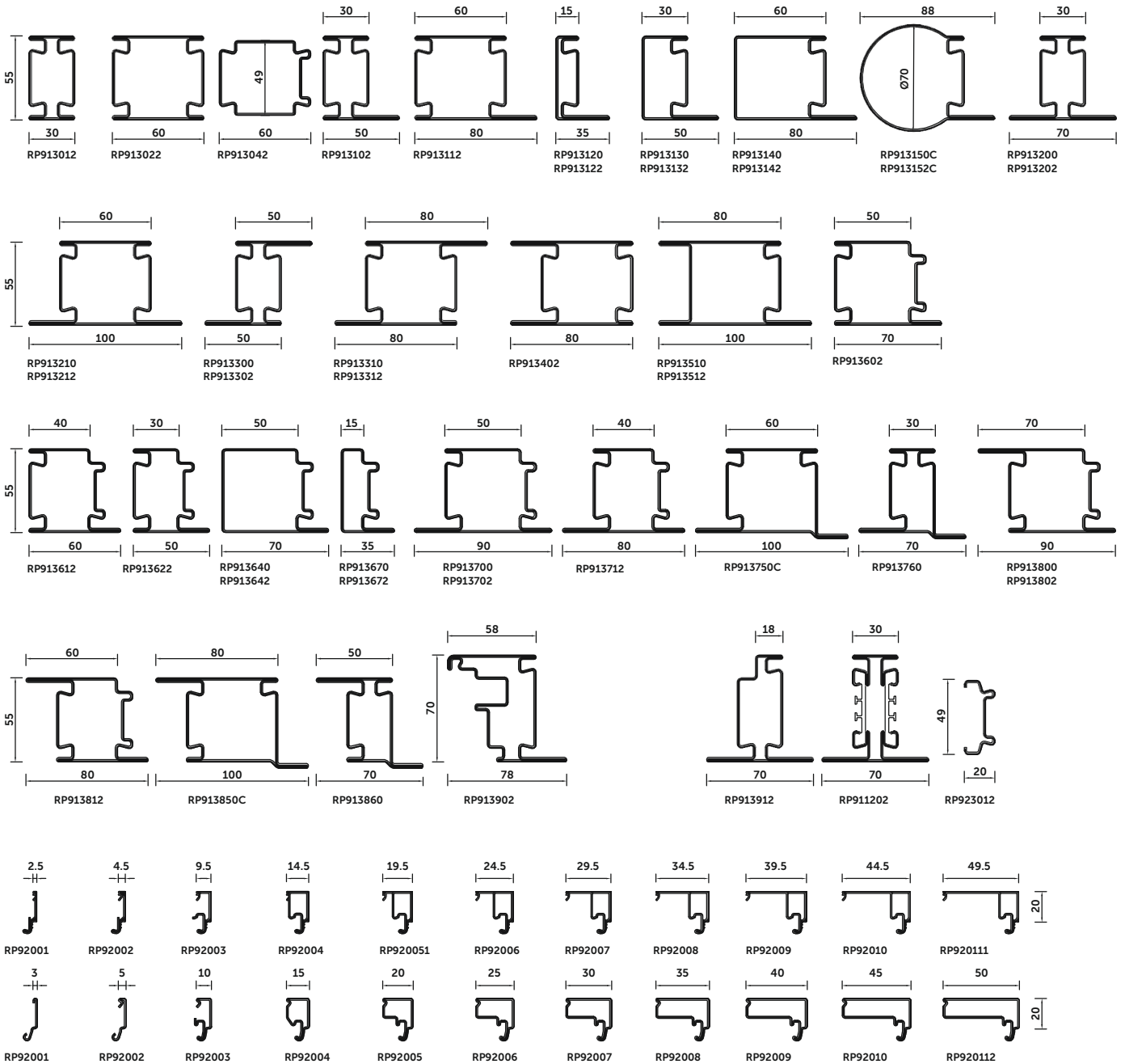

METALFORM

Kulturkirche St. Jakobi, Stralsund
Church of Culture St. Jakobi, Stralsund

Architektin / Architect:
Elke Meißner, Ingenieurteam Nord GbR



rp hermetic 55D

**Trennwände sowie ein- und zwei-
flügelige Türen aus Stahl, ungedämmt**
Steel profile system for partition walls
and doors for 1-leaf and 2-leaf doors,
non-insulated

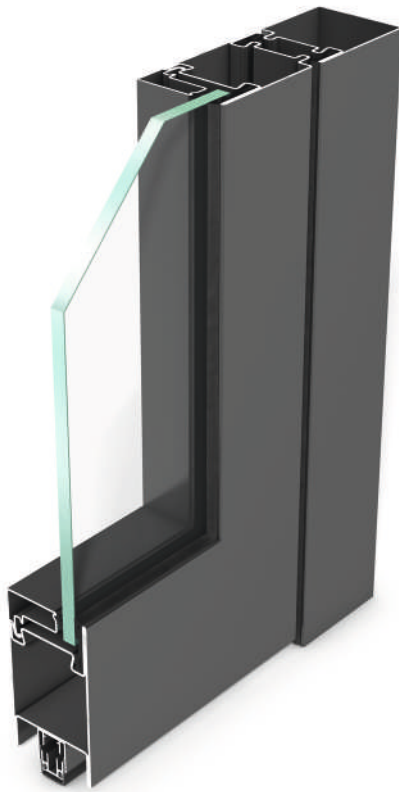

Ausführung als Tür
Door example

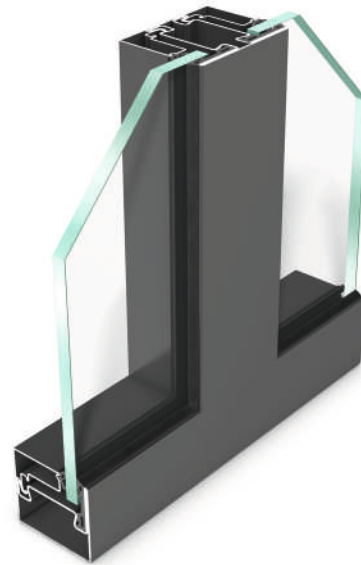

Ausführung als Trennwand
Partition wall example

Widerstandsfähigkeit gegen Windlast Resistance under wind load	C2
Luftdurchlässigkeit Air permeability	2
Schlagregendichtheit Watertightness	4A
Einbruchhemmung Burglar resistance	RC3
Fingerklemmschutz Finger trap protection	Ja Yes
Dauerfunktionsprüfung Continuous performance test	200.000 Zyklen / cycles
Dauerfunktionsprüfung mechanische Beanspruchung Continuous performance test: mechanical stress	bis C5 up to C5
Fähigkeit zur Freigabe Ability to release	erfüllt fulfilled
Mechanische Festigkeit Mechanical strength	4

rp hermetic 55D

Türen, nach innen öffnend

Doors, inward opening

METALFORM

Systemschnitte

Sections

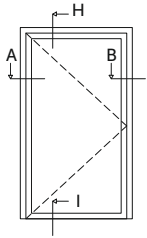

Anschlagtür, einflügelig
Single-action door, single-leaf

Verglasungsebene Standard
Glazing position, standard

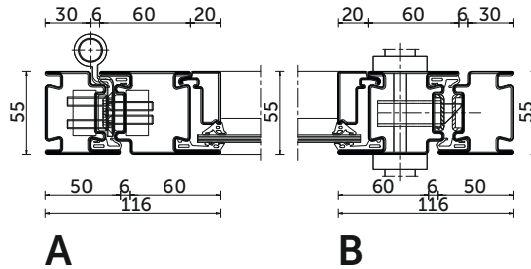

Ausführung mit Elektro-Magnet
(Objektlösung)
Version with electro-magnet
(project-specific solution)

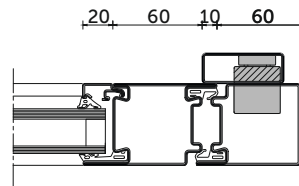

Ausführung mit Elektro-Magnet,
mit Flächenversatz (Objektlösung)
Version with electro-magnet, with
surface offset (project-specific solution)

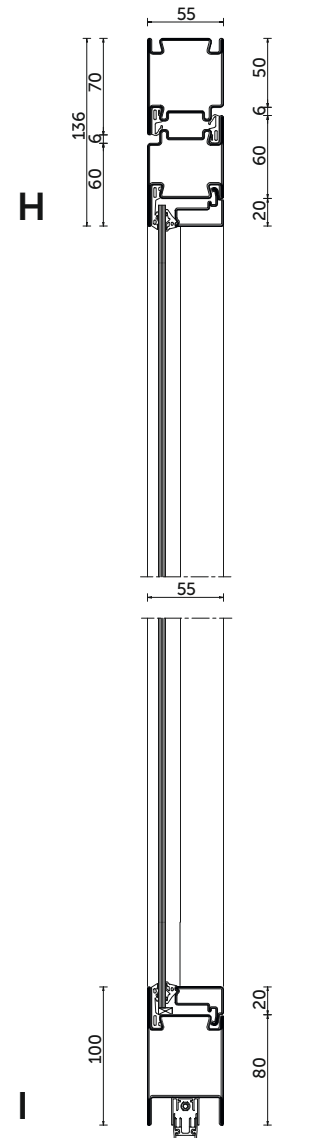
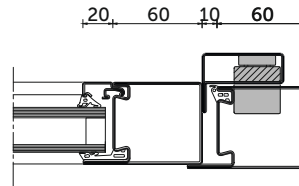

Anschlagtür nach innen öffnend
Single-action door, inward opening

Anschlagtür mit Finger-
klemmschutz, einflügelig
Single-action door with
anti-finger trap, single-leaf

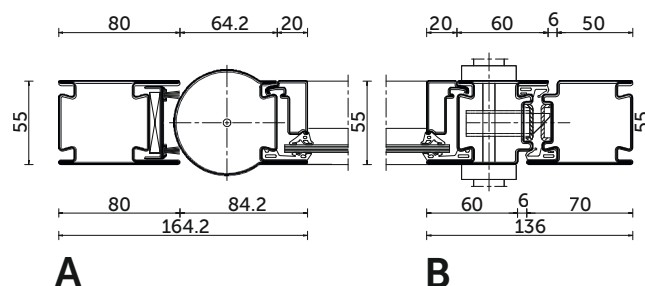

METALFORM

Anschlagtür, zweiflügelig
Single-action door, double-leaf

Verglasungsebene Standard
Glazing position, standard

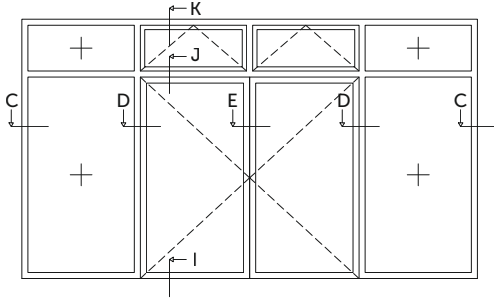
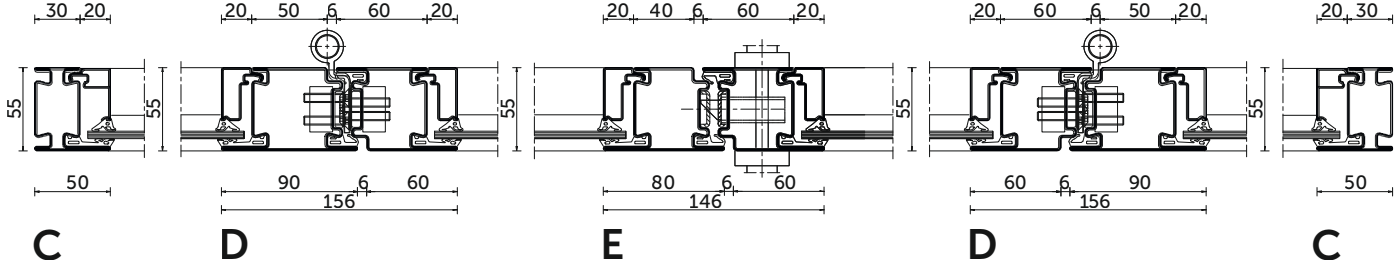

Verglasungsebene mittig
Glazing position, centred

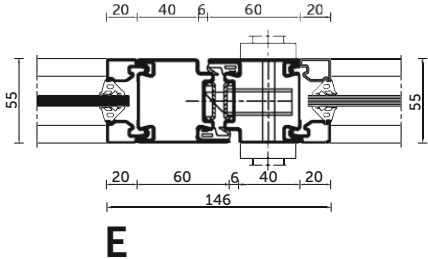

Ausführung mit Flächenversatz
Version with surface offset

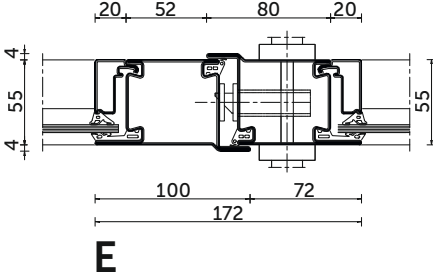

Optionale Sockellösung
Optional plinth solution

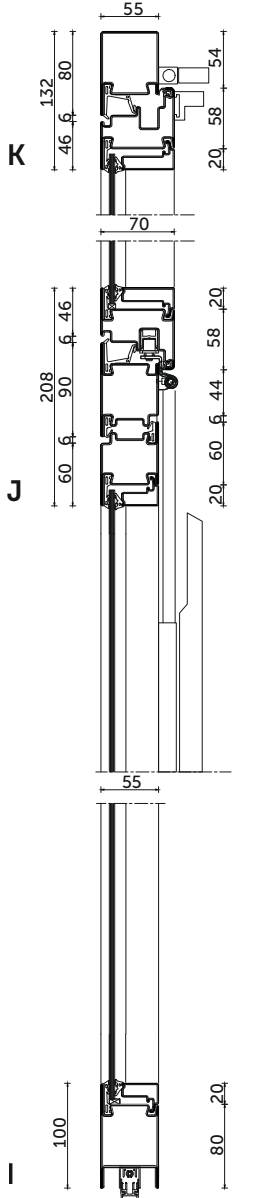
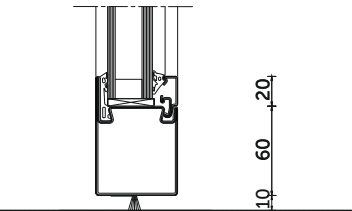

Anschlagtür mit Oberlicht
Single-action door with top light

rp hermetic 55D

Türen, nach außen öffnend

Doors, outward opening

METALFORM

Systemschnitte

Sections

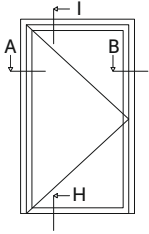

Anschlagtür, einflügelig
Single-action door, single-leaf

Verglasungsebene Standard
Glazing position, standard

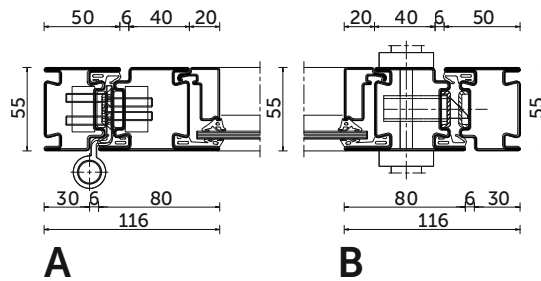

Verglasungsebene mittig
Glazing position, centred

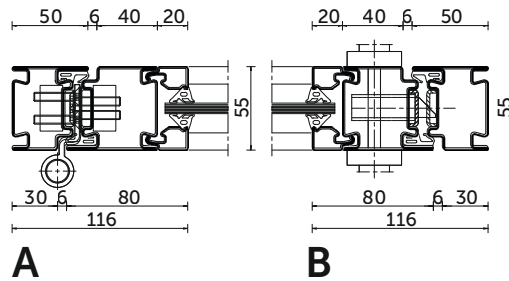

Ausführung mit
Flächenversatz
Surface offset example

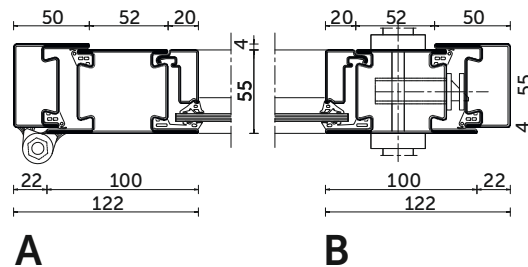

Anschlagtür mit Finger-
klemmschutz, einflügelig
Single-action door with finger
trap protection, single-leaf

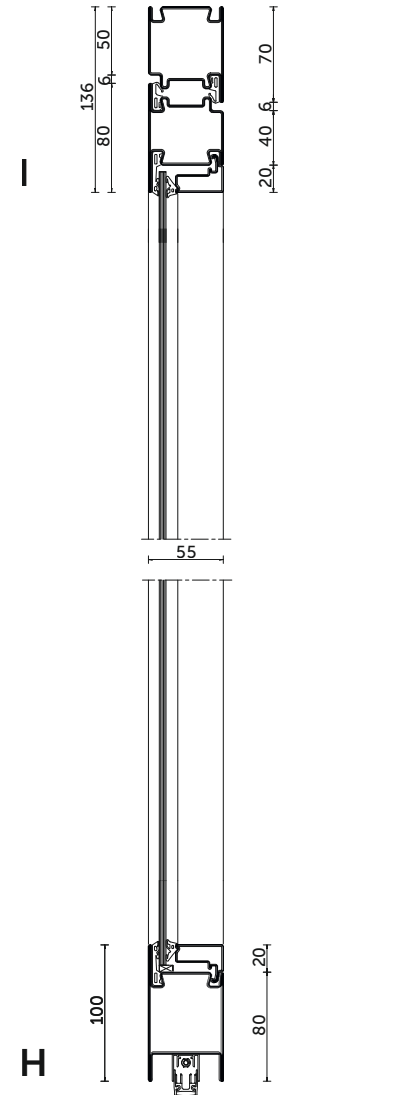
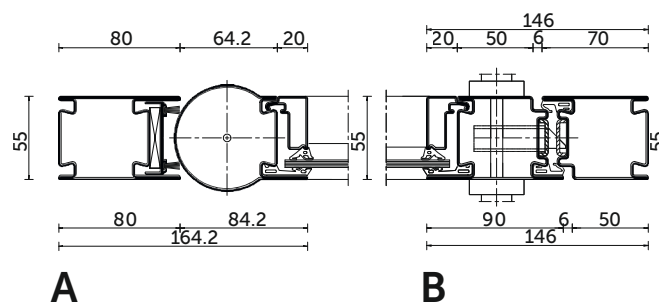

Anschlagtür nach außen öffnend
Single-action door, outward
opening

METALFORM

Anschlagtür, zweiflügelig Single-action door, double-leaf

Verglasungsebene Standard
Glazing position, standard

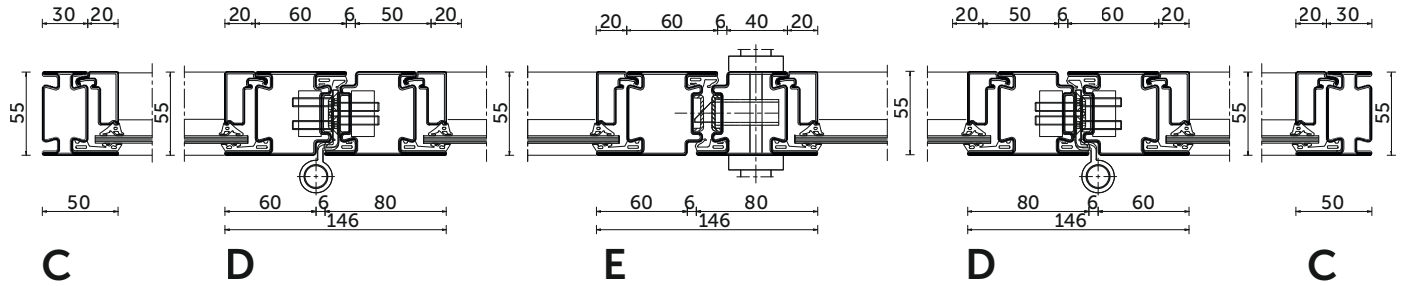

Verglasungsebene mittig
Glazing position, centred

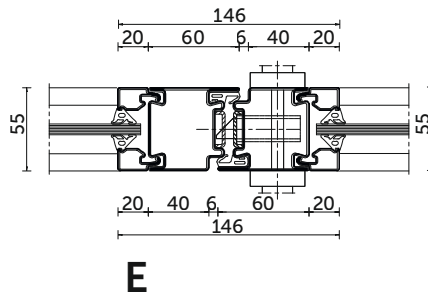

Ausführung mit Flächenversatz
Surface offset example

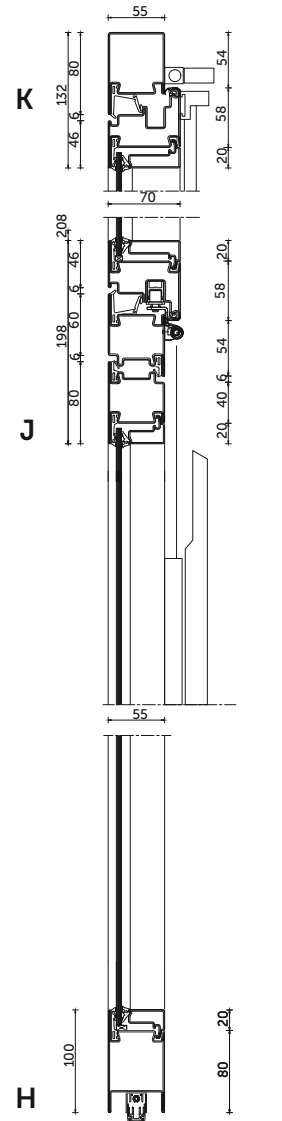
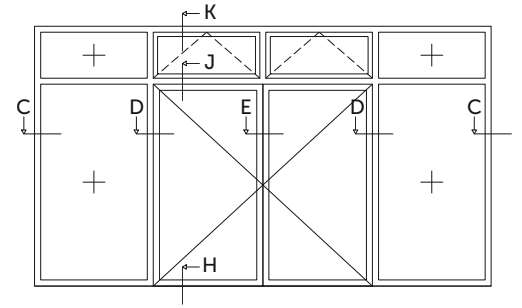
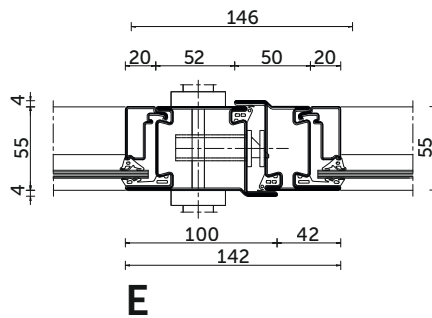

Anschlagtür mit Oberlicht
Single-action door with top light

rp hermetic 55W

**Fenster und Festverglasungen
aus Stahl, ungedämmt**

**Windows and fixed glazing in steel,
non-insulated**



Ausführung als Fenster
Window example

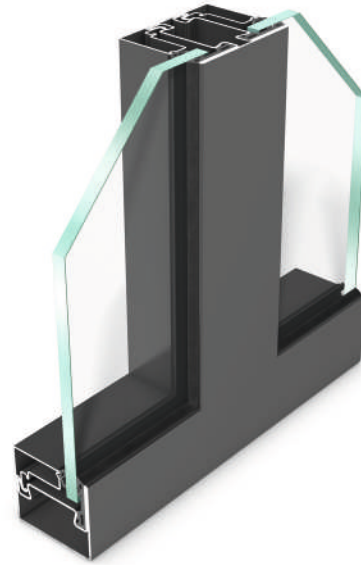

Ausführung als Festverglasung
Fixed glazing example

Absturzsicherheit
Fall protection barrier glazing

erfüllt
fulfilled

rp hermetic 55W

Fenster, nach innen öffnend

Window, inward opening

Systemechnitte

Sections

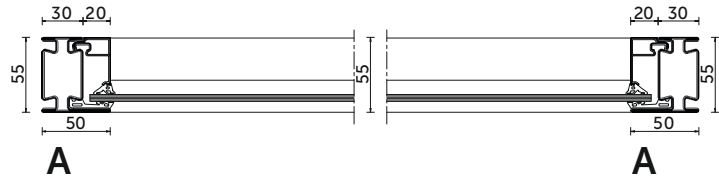
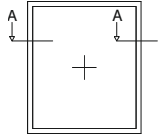

Festverglasung
Fixed glazing

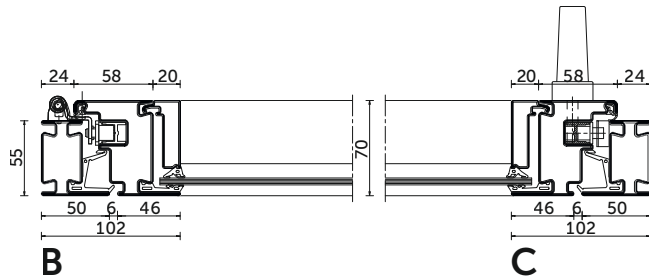
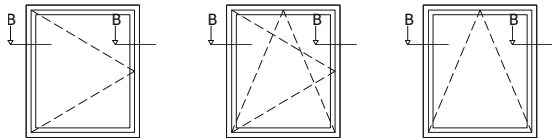

Fenster, einflügelig; diverse Beschlagvarianten möglich;
Dreh-Kipp, Kipp; hier dargestellt: Dreh
Window, single-leaf; various hardware options possible;
turn-tilt, tilt; turn option shown above

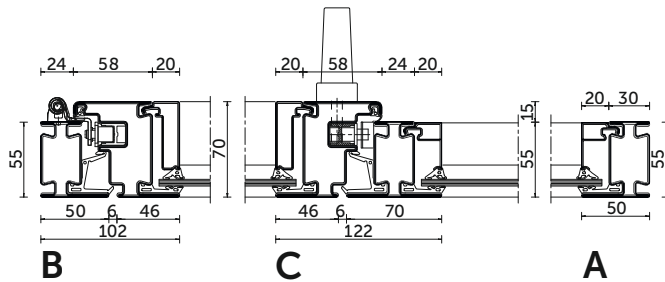
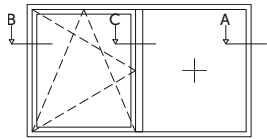

Fensterelement mit Seitenteil Dreh-Kipp / Festverglasung
Window element with side part turn-tilt / fixed glazing

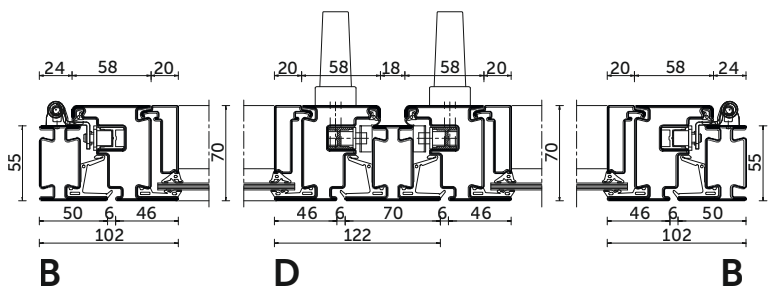
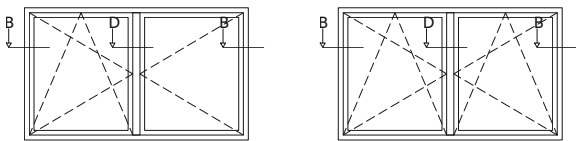

Fensterelement mit Mittelpfosten Dreh-Kipp / Dreh
Window element with centre mullion turn-tilt / turn

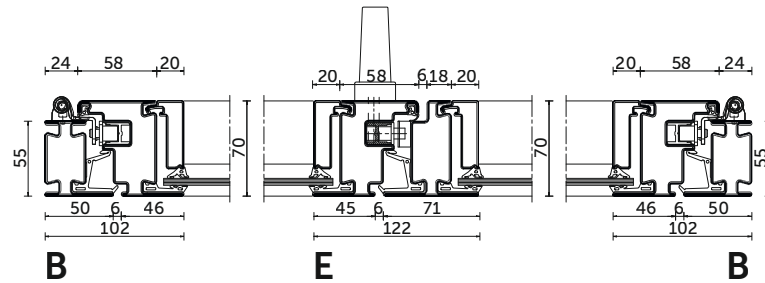
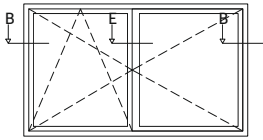

Finstererelement mit Stulpprofil Dreh-Kipp / Dreh
Window element with faceplate profile turn-tilt / turn

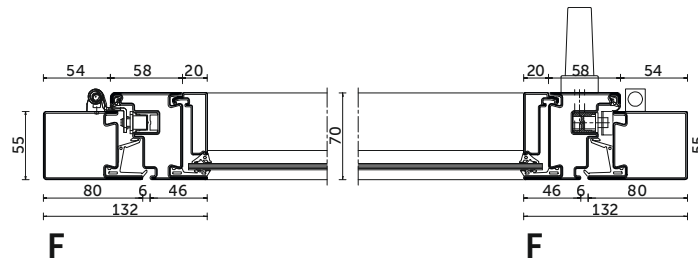
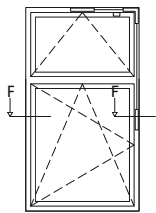

Finstererelement Dreh-Kipp mit Oberlicht Kipp
Window element turn-tilt with top light tilt

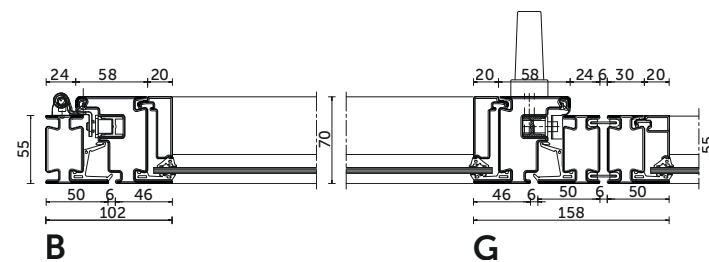
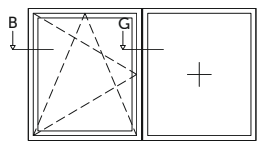

Elementierte Bauweise möglich, Elementkopplung,
Dreh-Kipp / Festverglasung
Individual frames can be coupled. Turn-tilt/fixed
glazing shown above

rp hermetic 55W

Fenster, nach innen öffnend

Window, inward opening

METALFORM

Systemechnitte

Sections

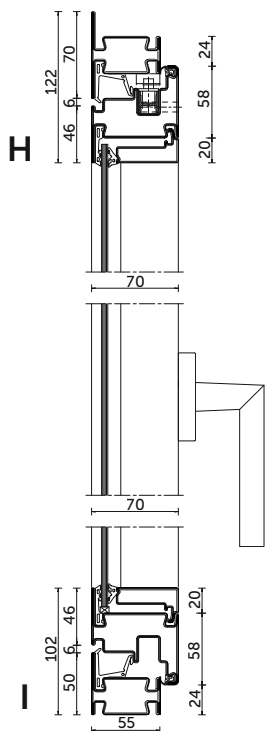
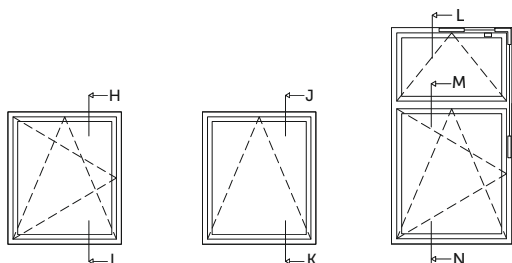

Fensterflügel mit Dreh
oder Dreh-Kipp-Beschlag
Window sash with turn or
turn-tilt fitting

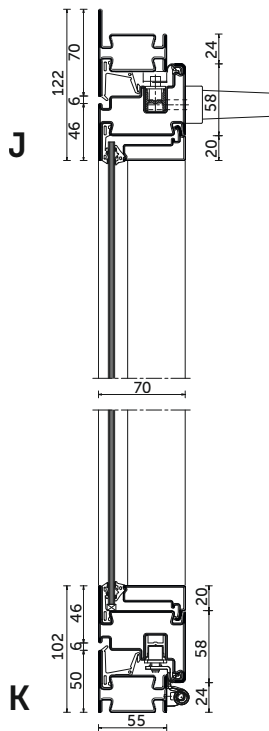

Fensterflügel mit Kipp-
Beschlag
Window sash with tilt fit-
ting

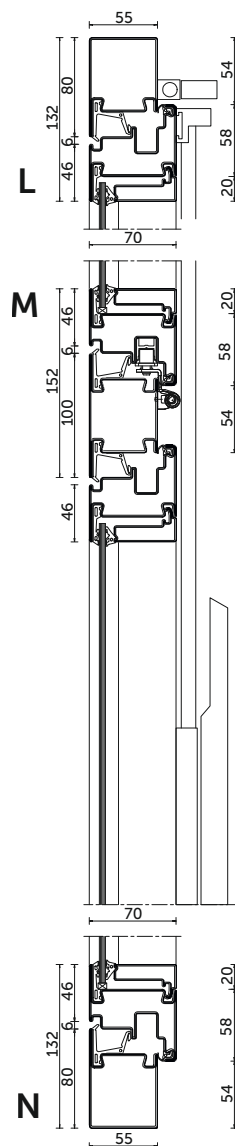

Fensterelement Dreh-
Kipp mit Oberlicht Kipp
Window element turn-tilt
with top tilt window

METALFORM

© Fotodesign Andreas Braun, Hamein



WILLKOMMEN IM HUMBOLDT FORUM

Das Humboldt Forum führt weltberühmte Kulturen, Kunst und Wissenschaft zusammen. Mit seinen Programmen in Kunst, Literatur, Religion, Wissenschaft und Politik verbindet es in einer lebendigen Atmosphäre die Menschen der Welt. Es ist ein Ort der Begegnung und des Dialogs.

Das Humboldt Forum ist ein Ort der Begegnung und des Dialogs. Es verbindet die Menschen der Welt in einer lebendigen Atmosphäre. Es ist ein Ort der Begegnung und des Dialogs.

Nach der Wiedereröffnung gibt es viele Chancen, um den gemeinsamen Dialog und Austausch zu fördern. Die Begegnung der Kulturen ist ein zentraler Bestandteil der Arbeit des Humboldt Forums. Es ist ein Ort der Begegnung und des Dialogs.

Das Humboldt Forum ist ein Ort der Begegnung und des Dialogs. Es verbindet die Menschen der Welt in einer lebendigen Atmosphäre. Es ist ein Ort der Begegnung und des Dialogs.

rp hermetic 55RS

**Rauchschutztüren aus Stahl,
ungedämmt**

Smoke protection doors made of steel,
non-insulated

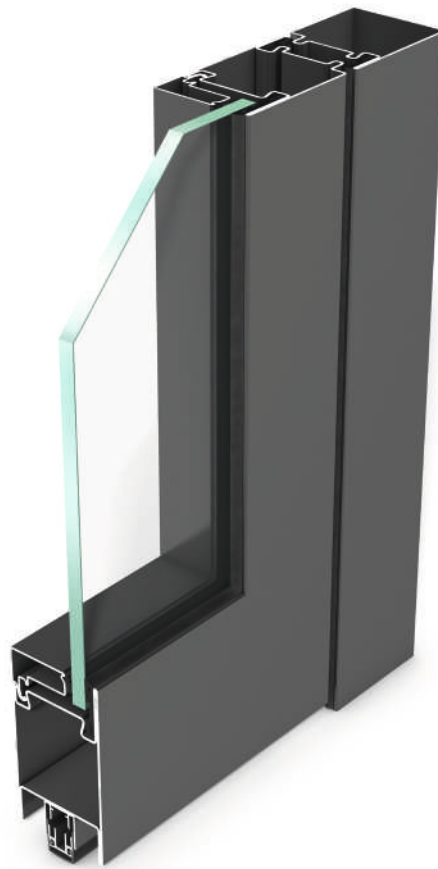

Rauchschutz (national: Deutschland)
Smoke protection (national: Germany)

RS-1 / RS-2

Rauchschutz (europäisch)
Smoke protection (Europe)

S_a / S₂₀₀ (geprüft / approved)

Dauerfunktionsprüfung
Continuous performance test

200.000 Zyklen / cycles

Dauerfunktionsprüfung
mechanische Beanspruchung
Continuous performance test:
mechanical stress

C5 (geprüft / approved)

Bei der Anwendung sind die jeweiligen nationalen Anforderungen, Richtlinien und Bauordnungen der Länder unter Berücksichtigung der vorliegenden Prüfnachweise und deren Anerkennung zu beachten.

When putting together applications, the respective national requirements, guidelines and building regulations of the country concerned must be observed with consideration of the available test certificates and their approval.

Systemübersicht
System overview

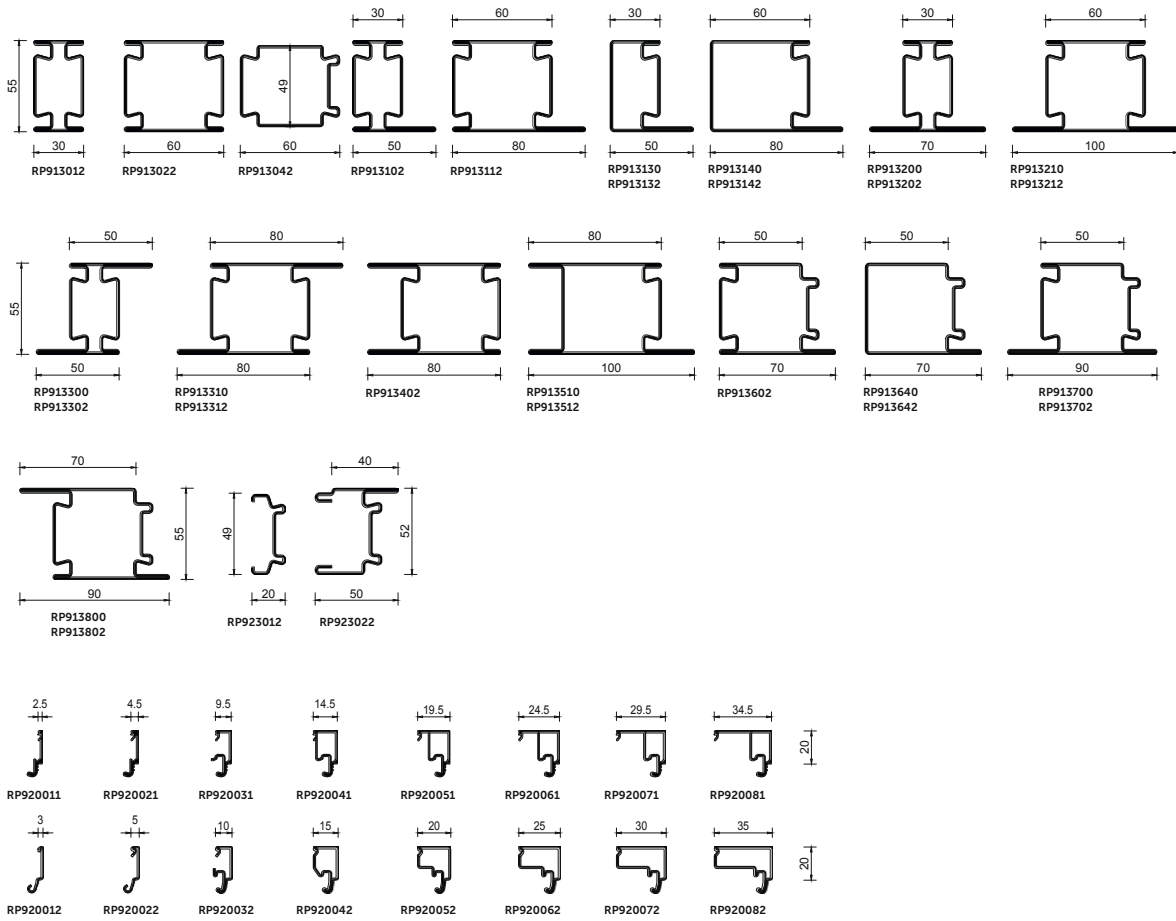

Systemschnitte
Sections

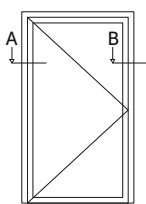

Anschlagtür, einflügelig, auswärts öffnend
Single-action door, single-leaf, outward opening

Verglasungsebene Standard
Glazing position, standard

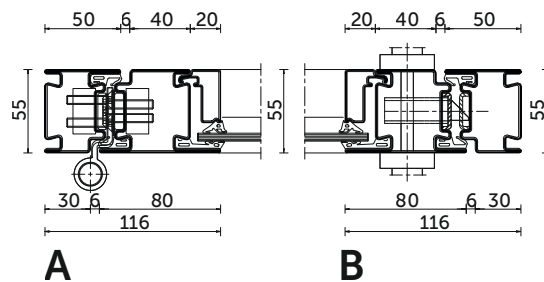

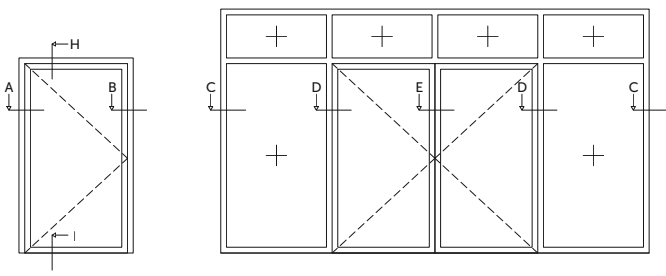

Anschlagtür, einflügelig, nach innen öffnend
Single-action door, single-leaf, inward opening

Verglasungsebene Standard
 Glazing level, standard

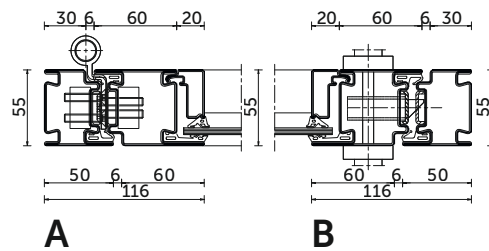

Verglasungsebene mittig
 Glazing position, centred

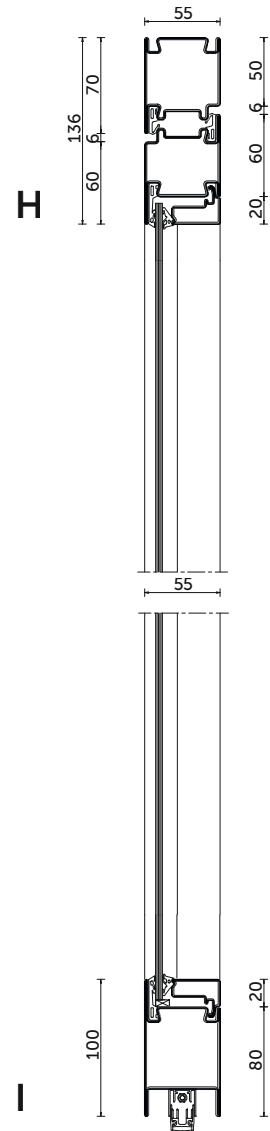
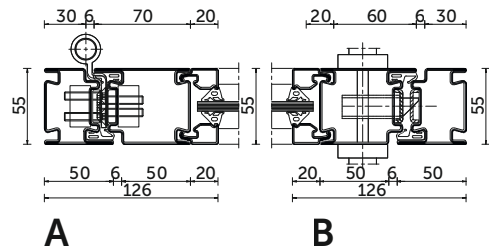

Anschlagtür, zweiflügelig, nach innen öffnend
Single-action door, double-leaf, inward opening

Verglasungsebene Standard
 Glazing position, standard

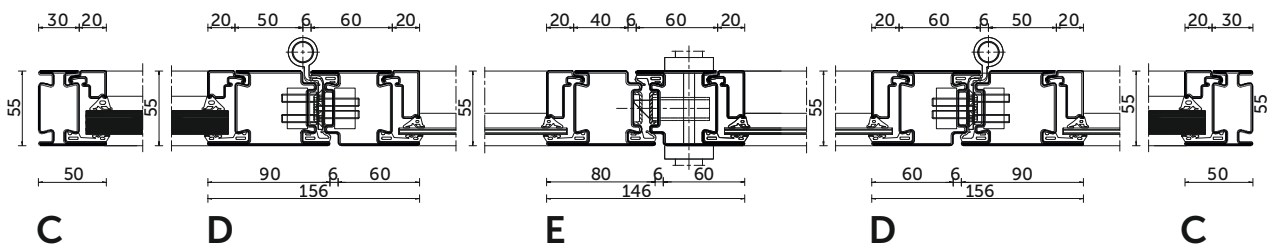

Verglasungsebene mittig
 Glazing position, centred

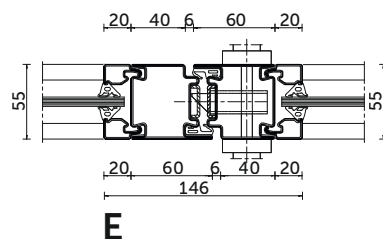

rp hermetic 55FP

Brandschutztüren und -trennwände aus Stahl, ungedämmt

Steel door profile system for fire
protection doors and partition walls,
non-insulated

Tür
Door

Trennwände
Partition walls

Leistungseigenschaften
Performance characteristics

Brandschutz E (Trennwände)
Fire protection E (partition walls)

Brandschutz EW (Trennwände)
Fire protection EW (partition walls)

**Brandschutz E
(Türen)**
Fire protection E (doors)

**Brandschutz EW
(Türen)**
Fire protection EW (doors)

rp hermetic 55

Tür
Door

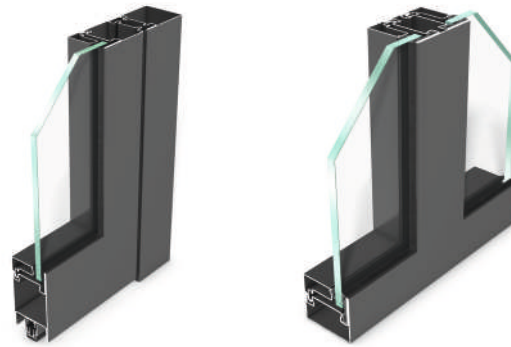

Trennwand
Partition wall



Upgrade

Brandschutz durch Brandschutzglas
Fire protection with safety glass



rp hermetic 55FP-30

rp hermetic 55FP-60

rp hermetic 55FP-90

rp hermetic 55FP-120

rp hermetic 55FP-180

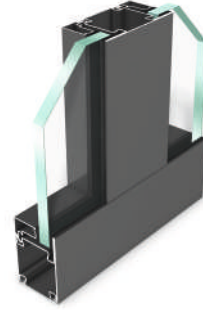
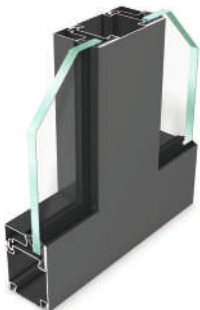
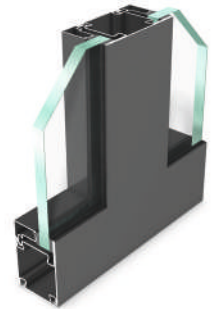

E30

E60

E90

E120

E180

EW30

EW60

EW90

EW120

E30

E60

E90

E120

EW30

EW60

EW90

EW120

Bei der Anwendung sind die jeweiligen nationalen Anforderungen, Richtlinien und Bauordnungen der Länder unter Berücksichtigung der vorliegenden Prüfnachweise und deren Anerkennung zu beachten.

When putting together applications, the respective national requirements, guidelines and building regulations of the country concerned must be observed with consideration of the available test certificates and their approval.

Systemübersicht
System overview

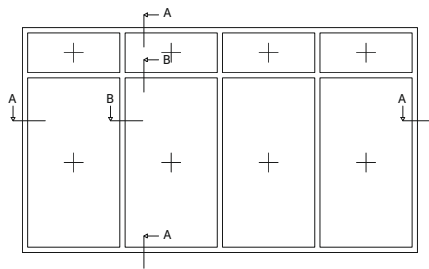
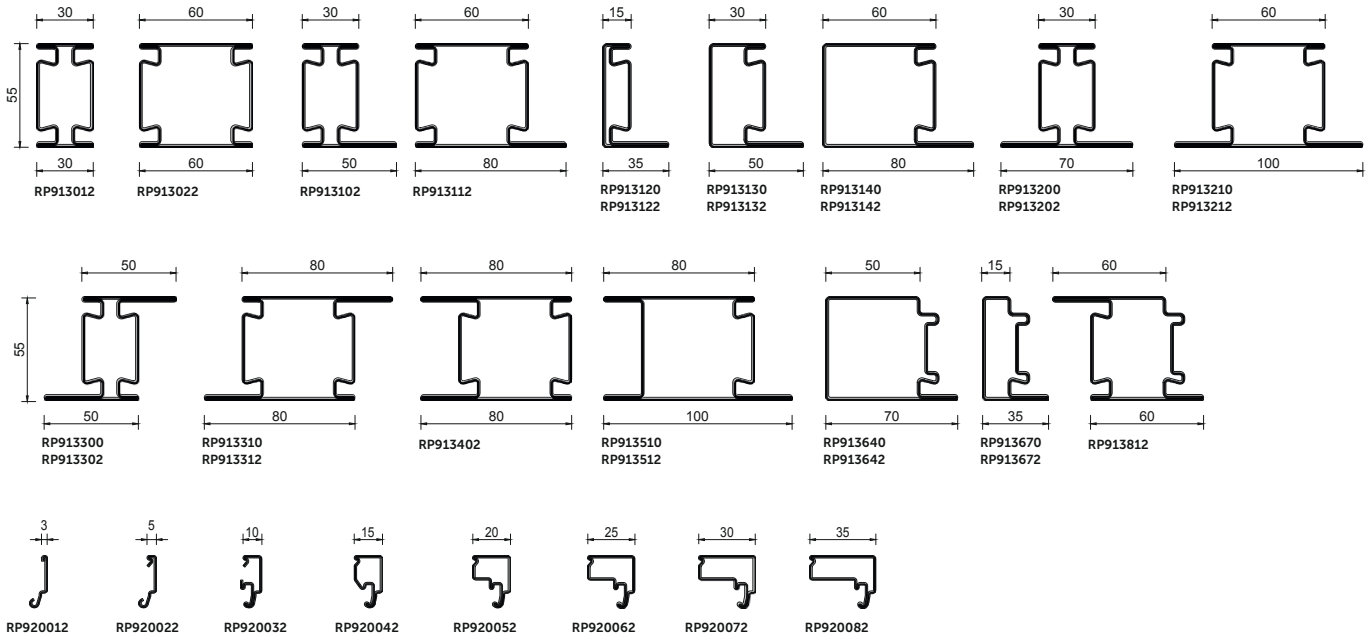

Verglasungsebene Standard
Glazing position, standard

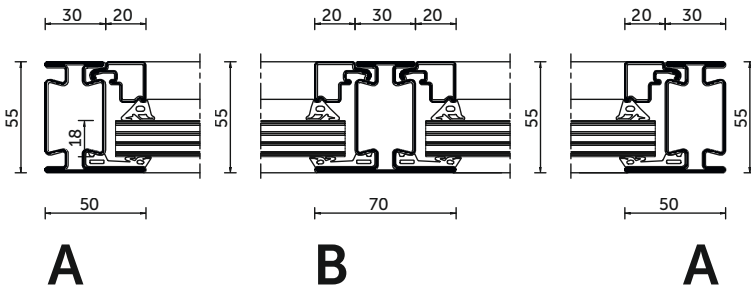

Verglasungsebene mittig
Glazing position, centred

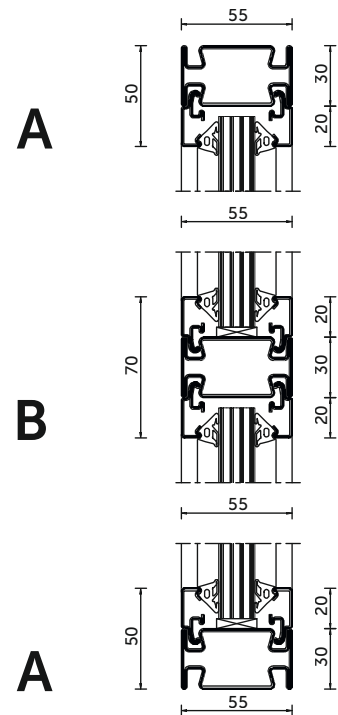

METALFORM

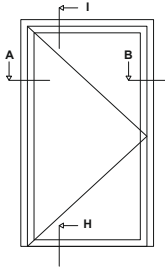

Anschlagtür, einflügelig
Single-action door, single-leaf

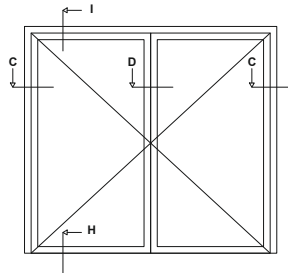
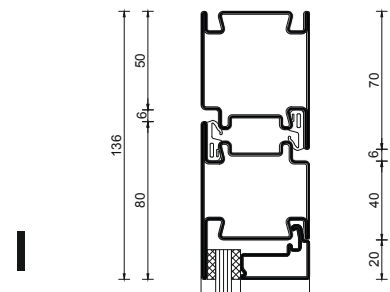
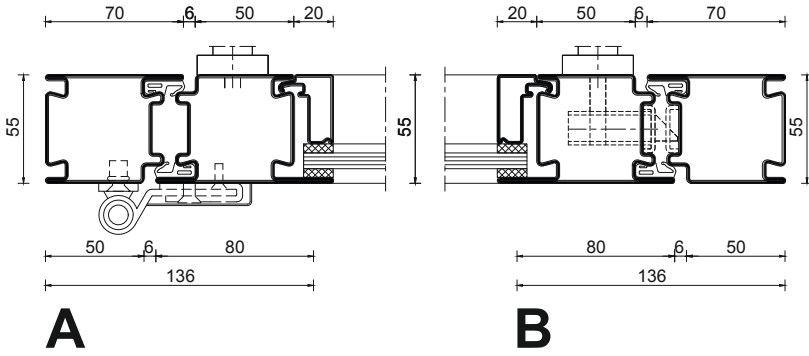

Anschlagtür, zweiflügelig
Single-action door, double-leaf

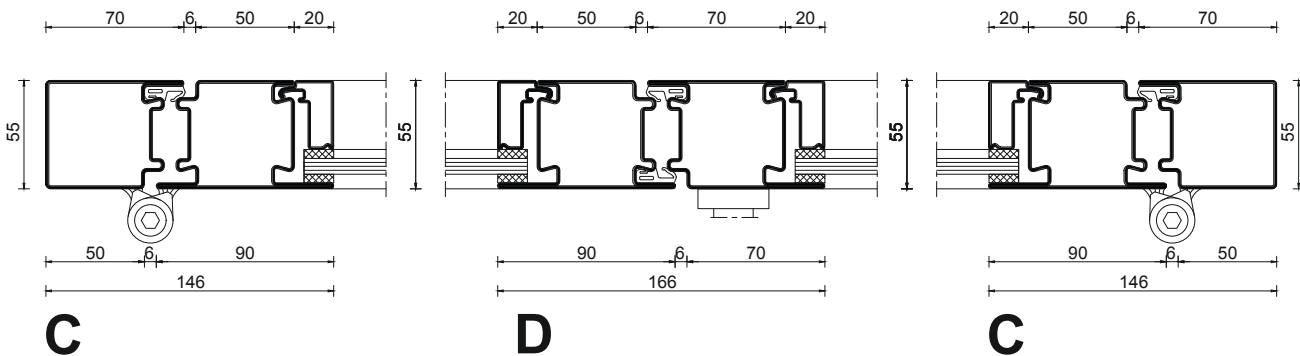

Anschlagtür, einflügelig
Single-action door, single-leaf

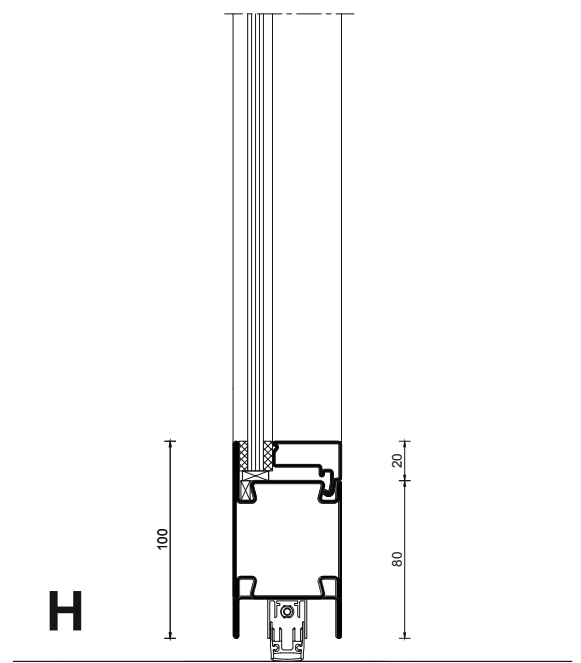



METALFORM

rp hermetic
Humboldt Forum, Berlin

Architekt / Architect:
Franco Stella



rp hermetic 70FP

**Türen und Trennwände für Brand- und
Rauchschutz durch Aufwertung des
wärmegeämmten Basissystems**

rp hermetic 70D

Doors and partition walls for fire and
smoke protection achieved by upgrading
the thermally insulated base system

rp hermetic 70D

Tür
Door

Trennwände
Partition walls

Leistungseigenschaften
Performance characteristics

Brandschutz EI (Türen)
Fire protection EI (doors)

Brandschutz EI (Trennwände)
Fire protection EI (partition walls)

Brandschutz F (Trennwände)
Fire protection F (partition walls)

Brandschutz T (Türen)
Fire protection T (doors)

Rauchschutz (national: Deutschland)
Smoke protection (national: Germany)

Rauchschutz (europäisch)
Smoke protection (Europe)

METALFORM

rp hermetic 70

Tür
Door

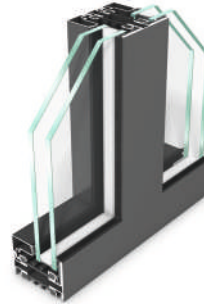
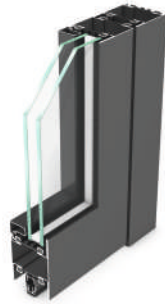

Trennwand
Partition wall



Upgrade
Brandschutz
Fire protection



rp hermetic 70FP-30



rp hermetic 70FP-60

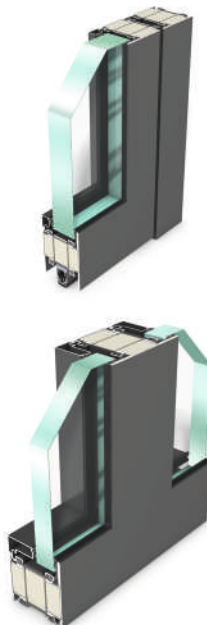

rp hermetic 70FP-90

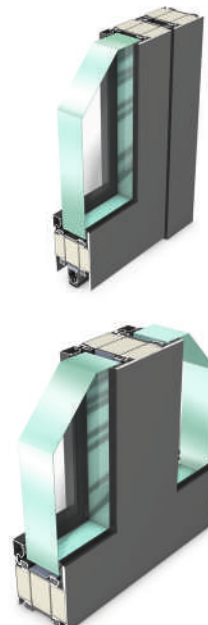

EI₂30

EI30

F30

T30

RS-1 / RS-2 (Türen / doors)

S_a / S₂₀₀ (Türen / doors)

EI₂60

EI60

EI₂90

EI90

F90

T90

RS-1 / RS-2 (Türen / doors)

S_a / S₂₀₀ (Türen / doors)

Bei der Anwendung sind die jeweiligen nationalen Anforderungen, Richtlinien und Bauordnungen der Länder unter Berücksichtigung der vorliegenden Prüfnachweise und deren Anerkennung zu beachten.

When putting together applications, the respective national requirements, guidelines and building regulations of the country concerned must be observed with consideration of the available test certificates and their approval.

rp hermetic 70FP-30

Türen und Trennwände für Brand- und Rauchschutz aus Stahl und Edelstahl, wärmege­dämmt

Steel door profile system for fire and smoke protection doors and partition walls, thermally insulated

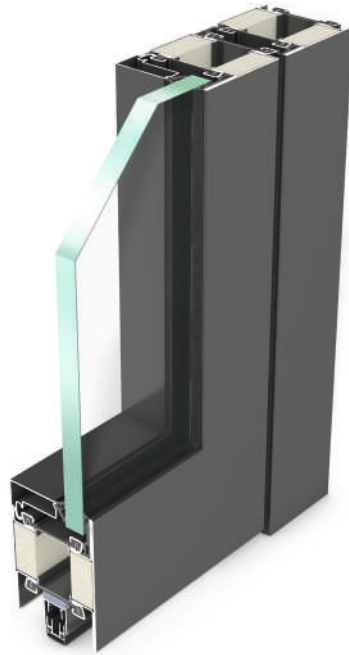

Ausführung als Tür
Model: Door

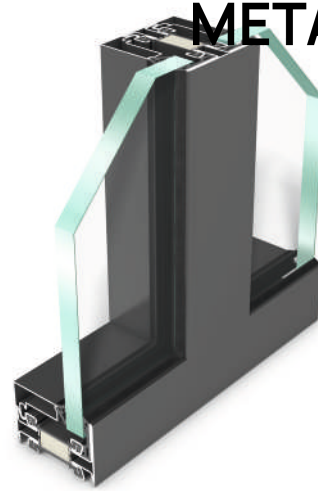

Ausführung als Trennwand
Model: Partition wall

Brandschutz EI (Türen) Fire protection EI (doors)	EI₂30
Brandschutz EI (Trennwände) Fire protection EI (partition walls)	EI30
Brandschutz T (Türen) Fire protection T (doors)	T30
Brandschutz F (Trennwände) Fire protection F (partition walls)	F30
Rauchschutz (national: Deutschland) Smoke protection (national: Germany)	RS-1 / RS-2 (Türen / doors)
Rauchschutz (europäisch) Smoke protection (Europe)	S_a / S₂₀₀ (Türen / doors)
Einbruchhemmung Burglar resistance	bis RC 3 up to RC 3
Schallschutz Sound insulation	≤ 44 dB (-1/-2) für Türen / for doors
Dauerfunktionsprüfung Continuous performance test	bis zu 1 Mio. Zyklen / up to 1 mio. cycles
Dauerfunktionsprüfung mechanische Beanspruchung Continuous performance test: mechanical stress	C5; C8
Fähigkeit zur Freigabe Ability to release	erfüllt fulfilled
Absturzsicherheit Fall protection barrier glazing	erfüllt (Trennwände) fulfilled (partition walls)
Mechanisches Leistungsverhalten Mechanical performance	erfüllt fulfilled
Mechanische Festigkeit Mechanical strength	4 (Türen / doors)

Bei der Anwendung sind die jeweiligen nationalen Anforderungen, Richtlinien und Bauordnungen der Länder unter Berücksichtigung der vorliegenden Prüfnachweise und deren Anerkennung zu beachten.

When putting together applications, the respective national requirements, guidelines and building regulations of the country concerned must be observed with consideration of the available test certificates and their approval.

Systemübersicht
System overview

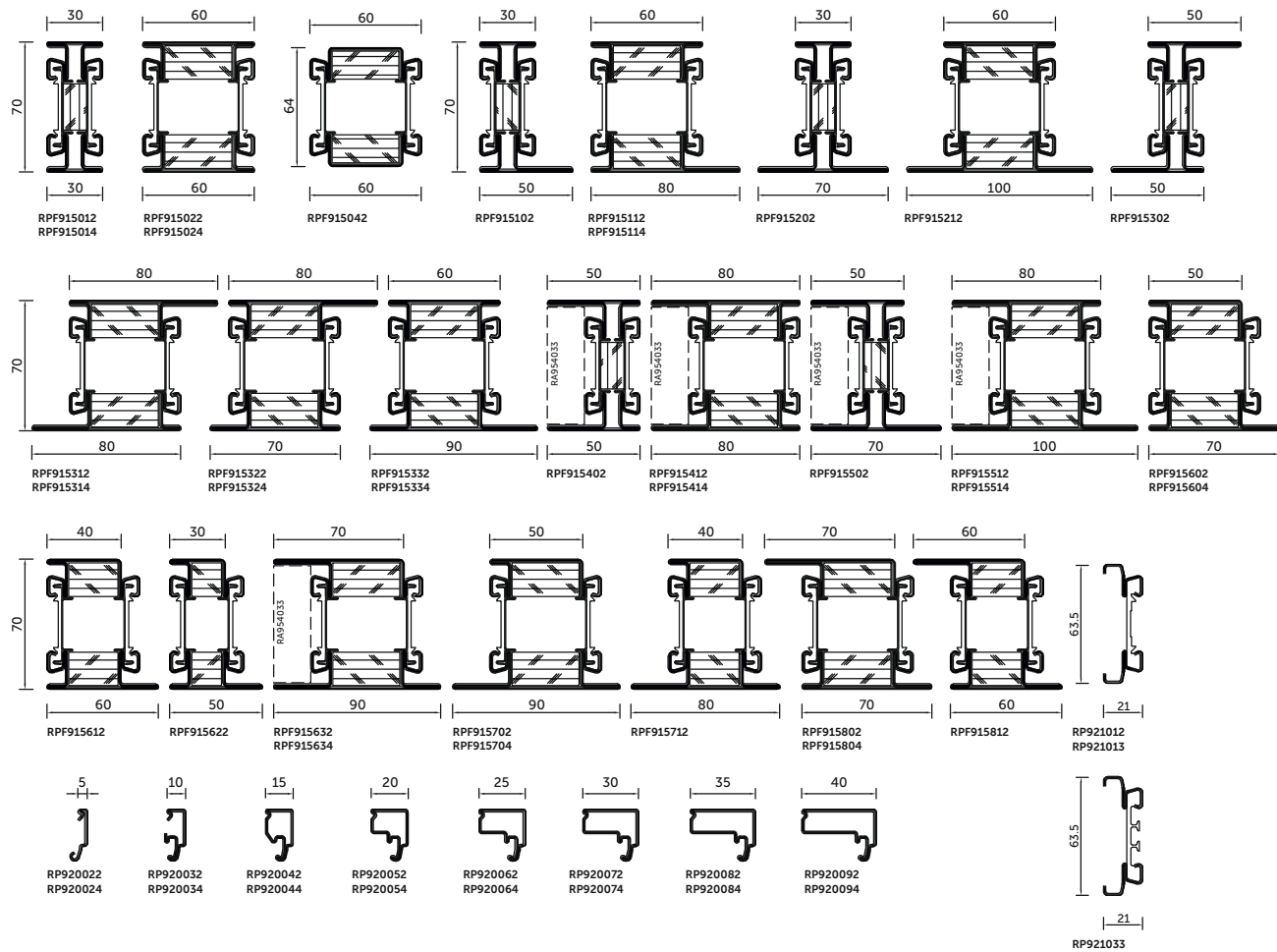

Systemschnitte / Sections

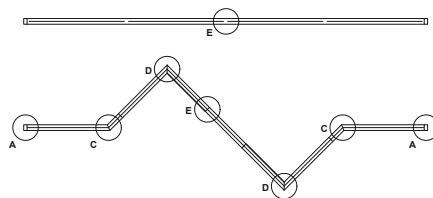
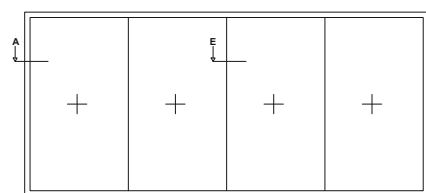

Festfeld mit Ganzglasstoß,
Ausführung in diversen
Winkeln möglich
Partition wall with butt-
jointed glass, execution in
various angles possible

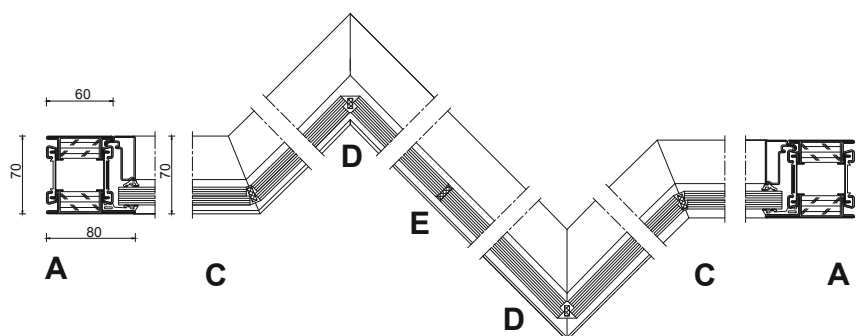

METALFORM

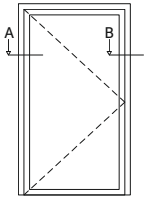

Anschlagtür, einflügelig, nach innen öffnend
Single-action door, single-leaf, inward opening

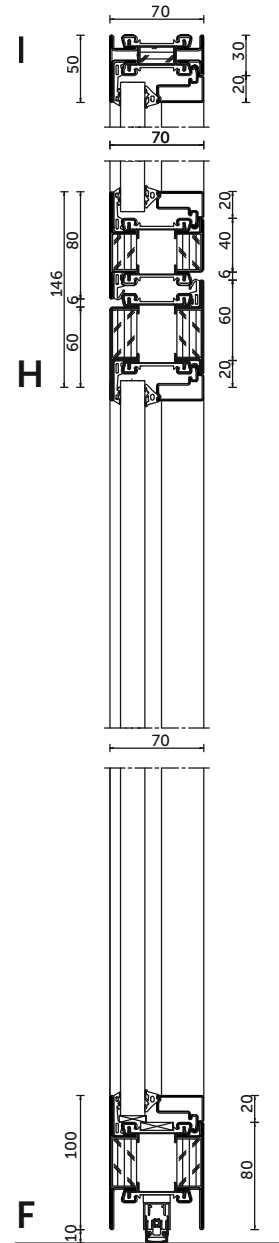
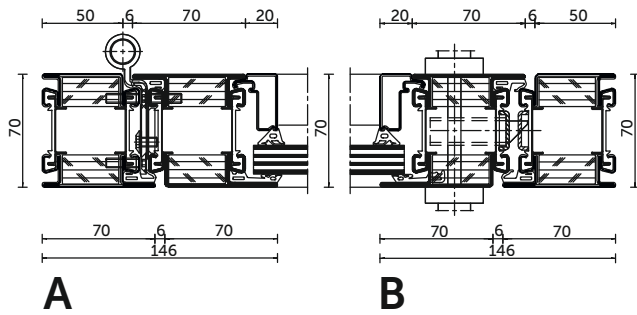

Anschlagtür mit Festfeld
Single-action door with fixed panel

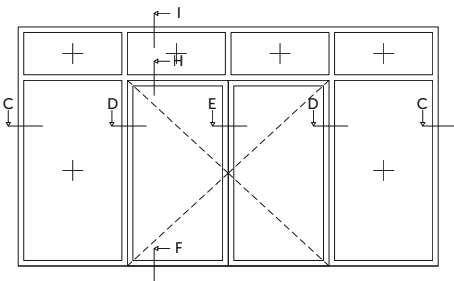

Anschlagtür, zweiflügelig, nach innen öffnend
Single-action door, double-leaf, inward opening

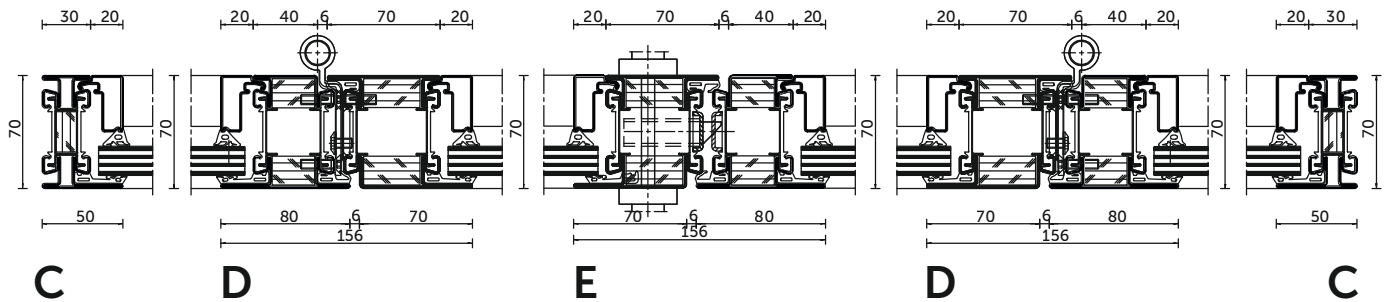

rp hermetic 70FP-60

**Türen und Trennwände für Brandschutz
aus Stahl, wärmege­dämmt**

**Steel profile system for fire protection doors
and partition walls, thermally insulated**

METALFORM

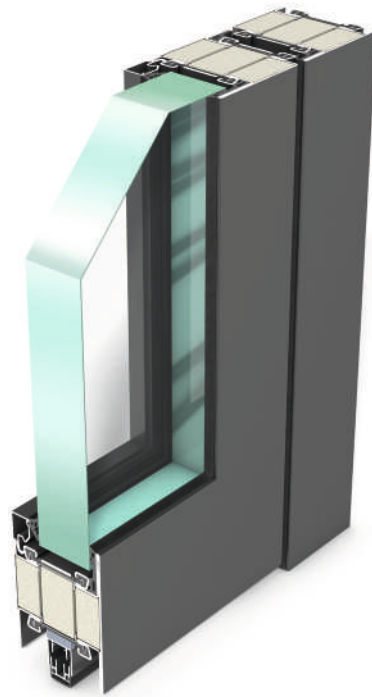

Ausführung als Tür
Model: Door

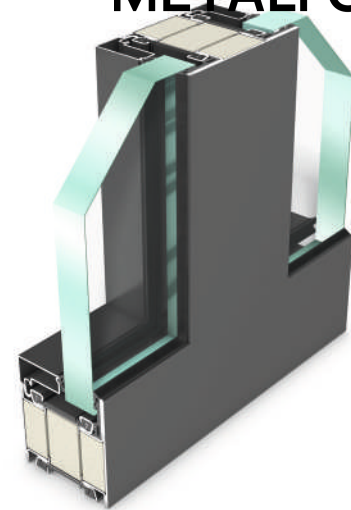

Ausführung als Trennwand
Model: Partition wall

Brandschutz EI (Türen) Fire protection EI (doors)	EI₂60
Brandschutz EI (Trennwände) Fire protection EI (partition walls)	EI60
Schallschutz Sound insulation	≤ 43 dB (0/-1) für Türen / for doors
Dauerfunktionsprüfung Continuous performance test	bis zu 1 Mio. Zyklen / up to 1 mio. cycles
Dauerfunktionsprüfung mechanische Beanspruchung Continuous performance test: mechanical stress	C5; C8
Fähigkeit zur Freigabe Ability to release	erfüllt fulfilled
Mechanisches Leistungsverhalten Mechanical performance	erfüllt fulfilled
Mechanische Festigkeit Mechanical strength	4 (Türen / doors)

Bei der Anwendung sind die jeweiligen nationalen Anforderungen, Richtlinien und Bauordnungen der Länder unter Berücksichtigung der vorliegenden Prüfnachweise und deren Anerkennung zu beachten.

When putting together applications, the respective national requirements, guidelines and building regulations of the country concerned must be observed with consideration of the available test certificates and their approval.

Systemübersicht
System overview

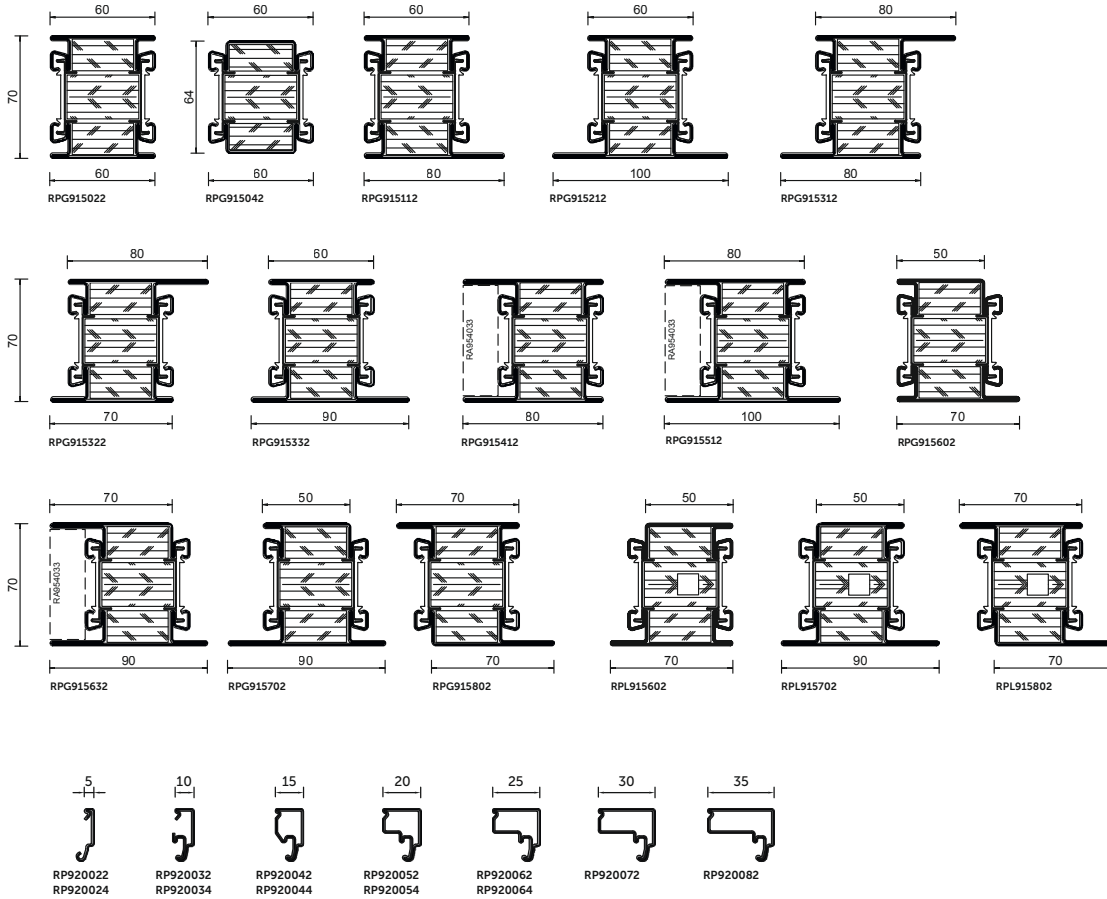

Systemschnitte / Sections

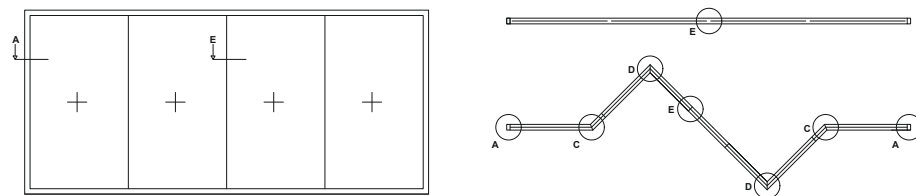

Festfeld mit Ganzglasstoß,
Ausführung in diversen
Winkeln möglich
Partition wall with butt-
jointed glass, execution in
various angles possible

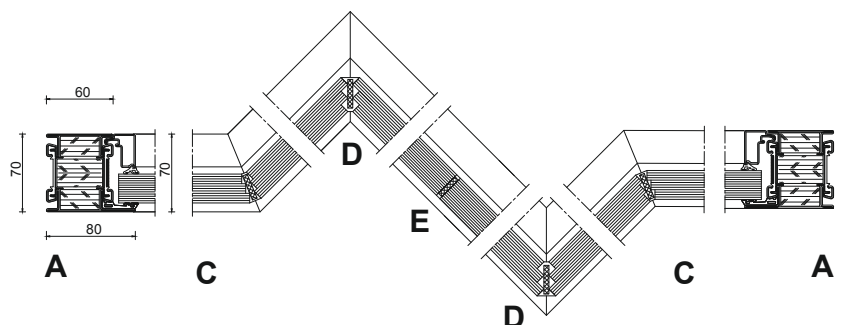

METALFORM

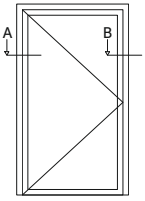

Anschlagtür, einflügelig, nach innen öffnend
Single-action door, single-leaf, inward opening

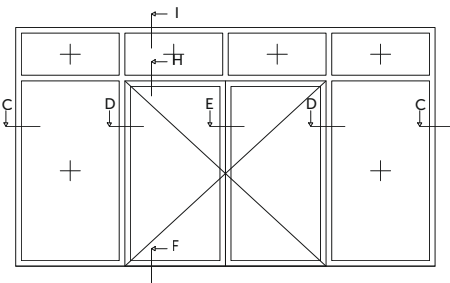
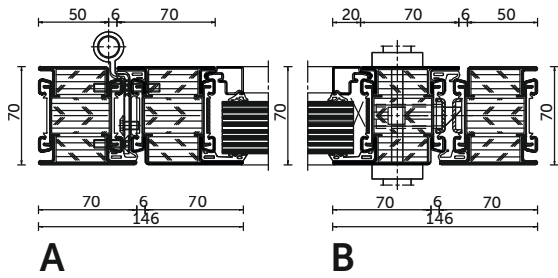

Anschlagtür, zweiflügelig, nach innen öffnend
Single-action door, double-leaf, inward opening

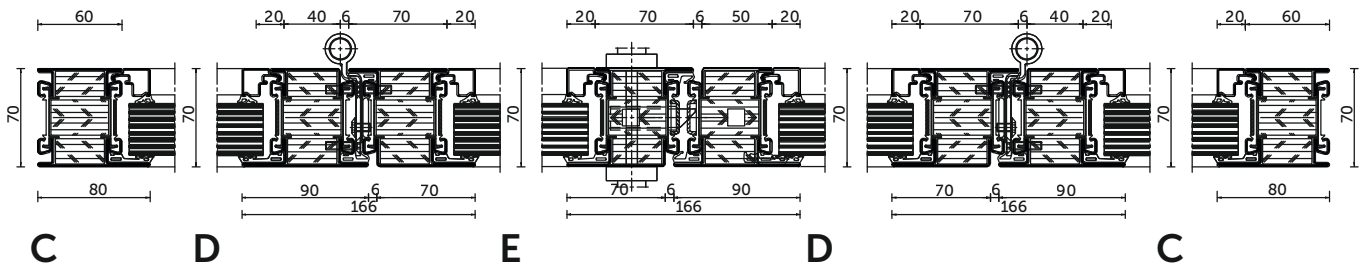

Pendeltür, zweiflügelig
Non-rebated two-leaf door

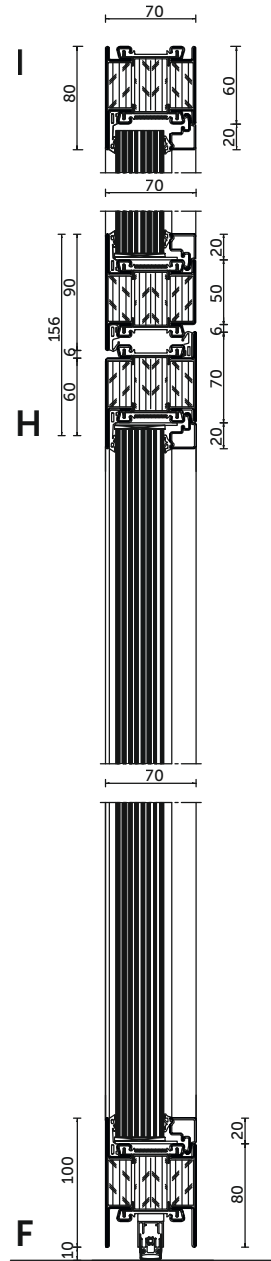
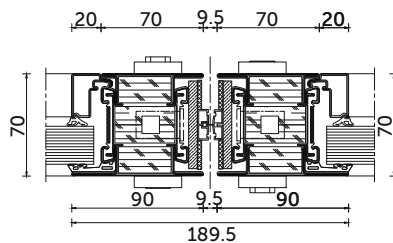

Anschlagtür mit Festfeld
Single-action door with fixed panel

rp hermetic 70FP-90

**Türen und Trennwände für Brand- und
Rauchschutz aus Stahl, wärmege­dämmt**
Steel profile system for fire & smoke protection
doors and partition walls, with thermal
insulation

METALFORM

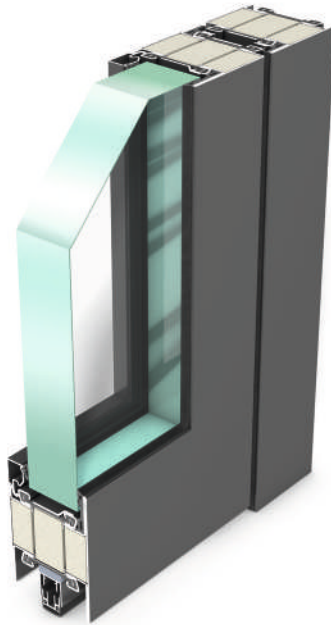

Ausführung als Tür
Model: Door

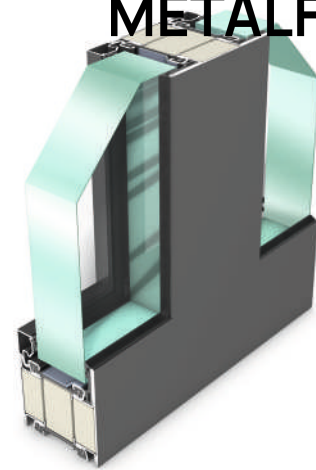

Ausführung als Trennwand
Model: Partition wall

Brandschutz EI (Türen) Fire protection EI (doors)	EI₂90
Brandschutz EI (Trennwände) Fire protection EI (partition walls)	EI90
Brandschutz T (Türen) Fire protection T (doors)	T90
Rauchschutz (national: Deutschland) Smoke protection (national: Germany)	RS-1 / RS-2 (Türen / doors)
Rauchschutz (europäisch) Smoke protection (Europe)	S_a / S₂₀₀ (Türen / doors)
Schallschutz Sound insulation	≤ 43 dB
Dauerfunktionsprüfung Continuous performance test	bis zu 1 Mio. Zyklen / up to 1 mio. cycles
Dauerfunktionsprüfung mechanische Beanspruchung Continuous performance test: mechanical stress	C5; C8
Fähigkeit zur Freigabe Ability to release	erfüllt fulfilled
Mechanisches Leistungsverhalten Mechanical performance	erfüllt fulfilled
Mechanische Festigkeit Mechanical strength	4 (Türen / doors)

Bei der Anwendung sind die jeweiligen nationalen Anforderungen, Richtlinien und Bauordnungen der Länder unter Berücksichtigung der vorliegenden Prüfnachweise und deren Anerkennung zu beachten.

When putting together applications, the respective national requirements, guidelines and building regulations of the country concerned must be observed with consideration of the available test certificates and their approval.

Systemübersicht
System overview

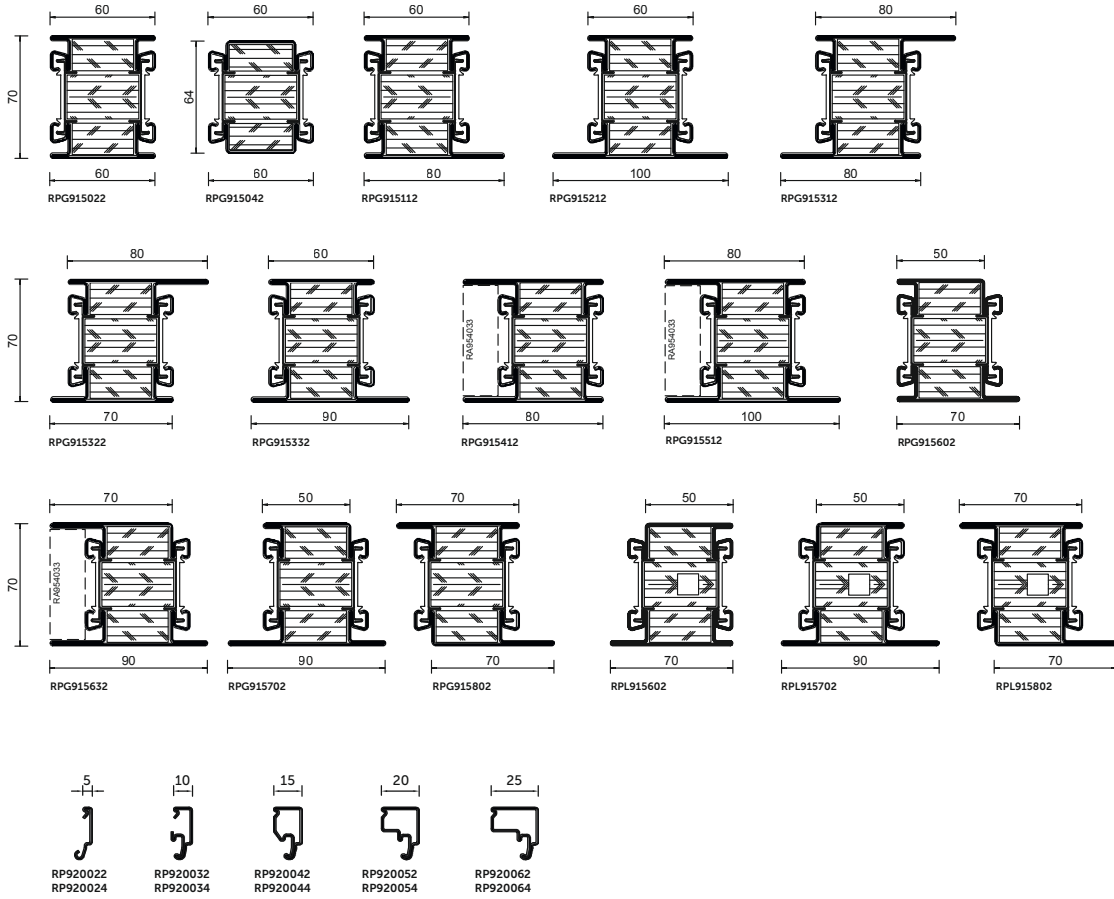

Systemechnitte Sections

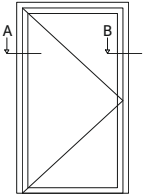

Anschlagtür, einflügelig, nach außen öffnend
Single-action door, single-leaf, outward opening

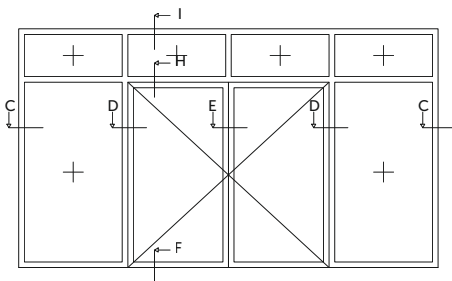
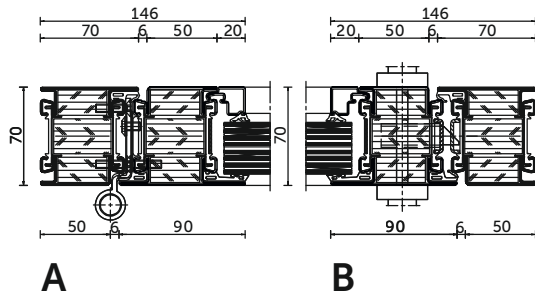

Anschlagtür, zweiflügelig, nach außen öffnend
Single-action door, double-leaf, outward opening

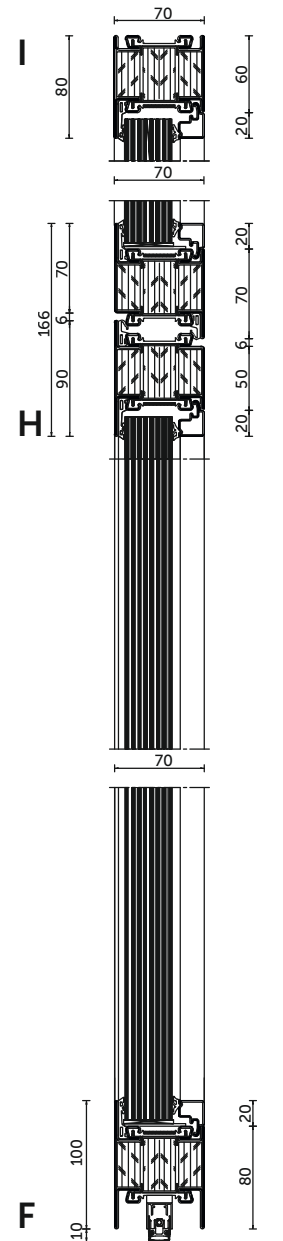
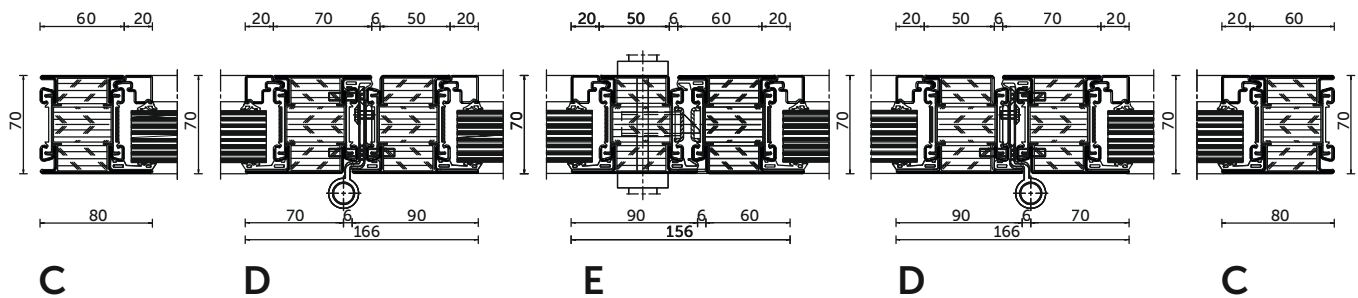

Anschlagtür mit Festfeld
Single-action door with fixed panel

B-C

Blok | Block

Yatan Hasta Girişİ
Inpatient Entrance





rp hermetic 90FP-120

Trennwände mit hohen Brandschutzanforderungen aus Stahl

Steel profile system for partition walls
with high fire protection requirements

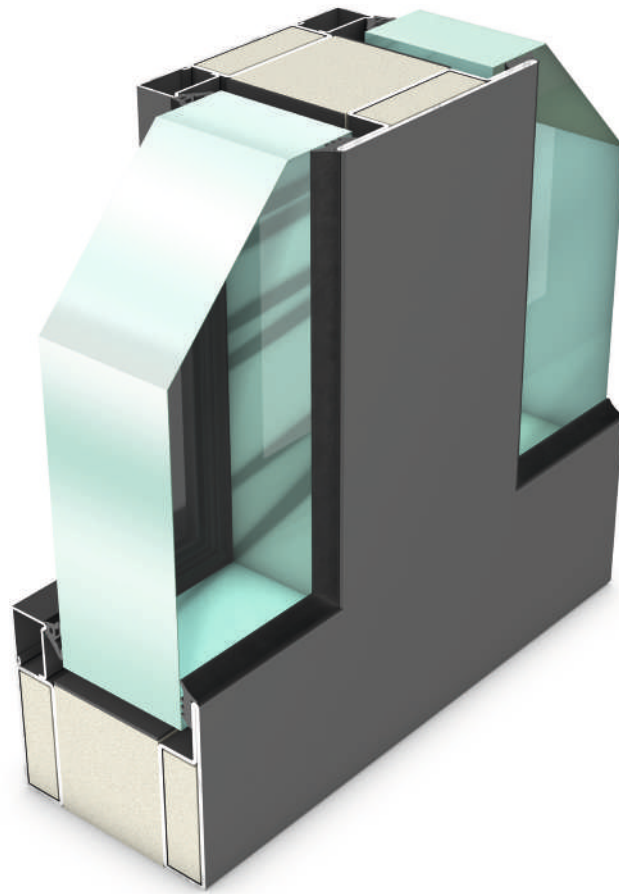

Brandschutz EI (Trennwände)
Fire protection EI (partition walls)

EI120

Bei der Anwendung sind die jeweiligen nationalen Anforderungen, Richtlinien und Bauordnungen der Länder unter Berücksichtigung der vorliegenden Prüfnachweise und deren Anerkennung zu beachten.

When putting together applications, the respective national requirements, guidelines and building regulations of the country concerned must be observed with consideration of the available test certificates and their approval.

rp hermetic 90FP-120

Trennwände
Partition walls

METALFORM

Systemübersicht

System overview

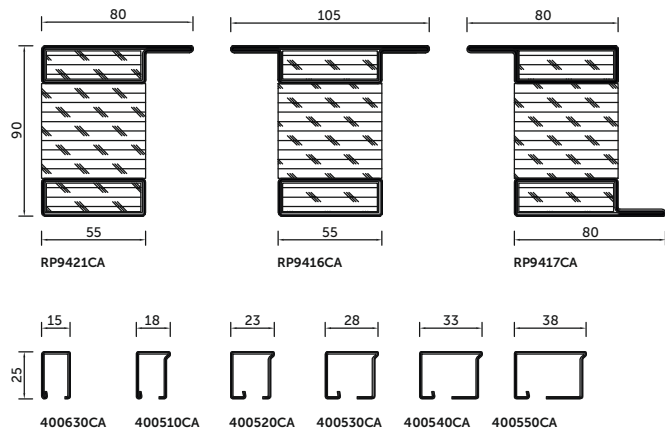

Systemschnitte

Sections

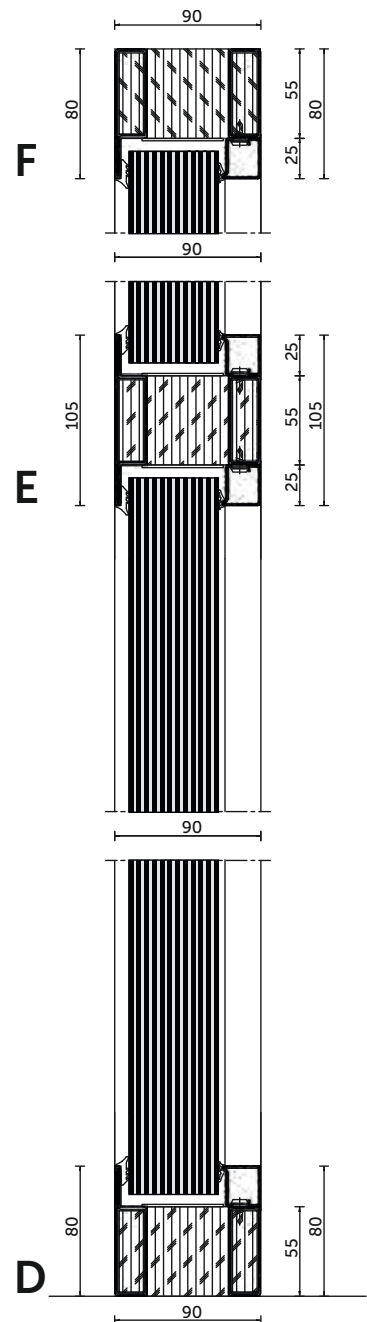
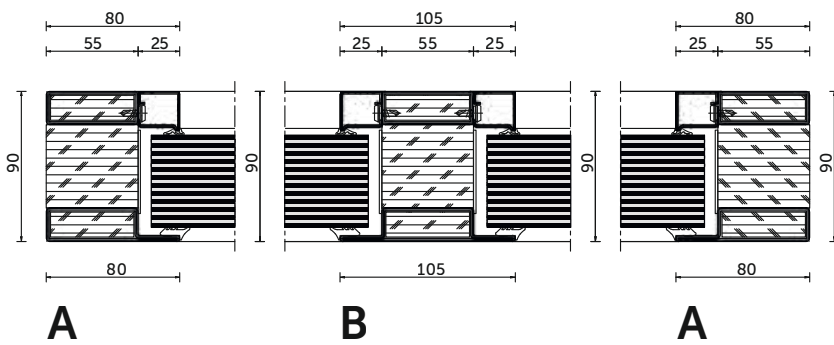
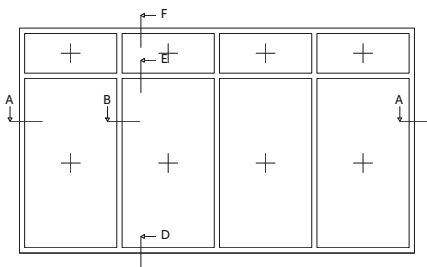



rp hermetic 75BR

**Durchschusshemmende Türen und
Trennwände aus Stahl, ungedämmt**
Bullet-resistant system for doors and
partition walls, non-insulated

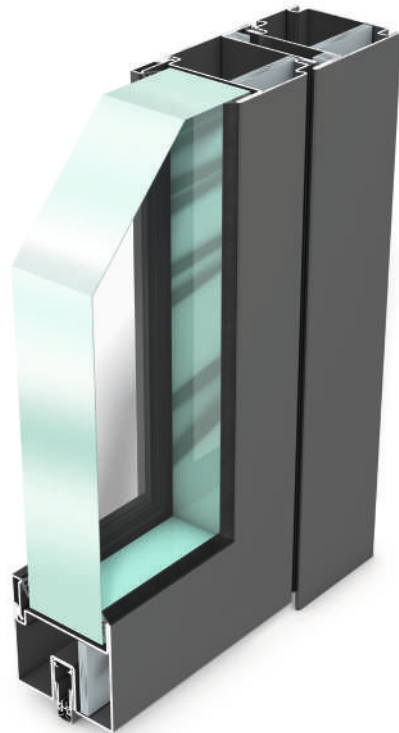

Ausführung als Tür
Door example

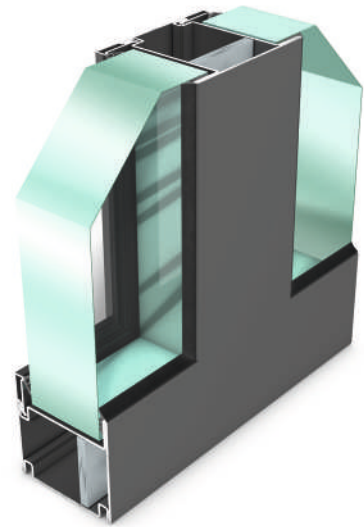

Ausführung als Trennwand
Partition wall example

Durchschusshemmung
Bullet resistance

FB4NS; FB6NS

Bei der Anwendung sind die jeweiligen nationalen Anforderungen, Richtlinien und Bauordnungen der Länder unter Berücksichtigung der vorliegenden Prüfnachweise und deren Anerkennung zu beachten.

When putting together applications, the respective national requirements, guidelines and building regulations of the country concerned must be observed with consideration of the available test certificates and their approval.

rp hermetic 75BR FB4

METALFORM

Durchschusshemmende Türen FB 4, nach innen öffnend

Bullet-resistant doors FB 4, inward opening

Systemübersicht

System overview

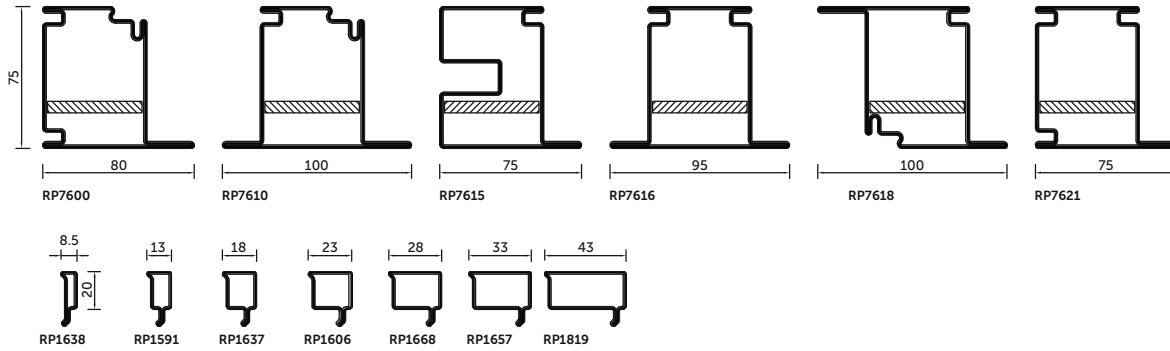

Systemechnitte

Sections

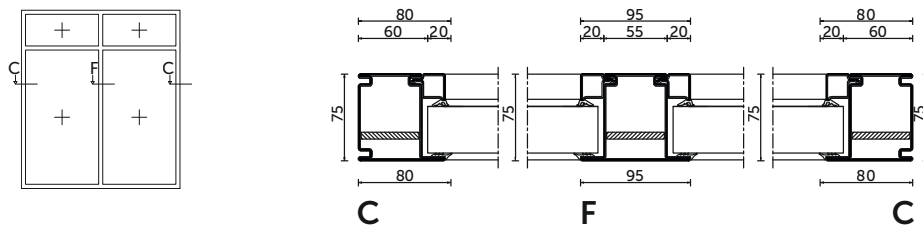

Trennwand
Partition wall

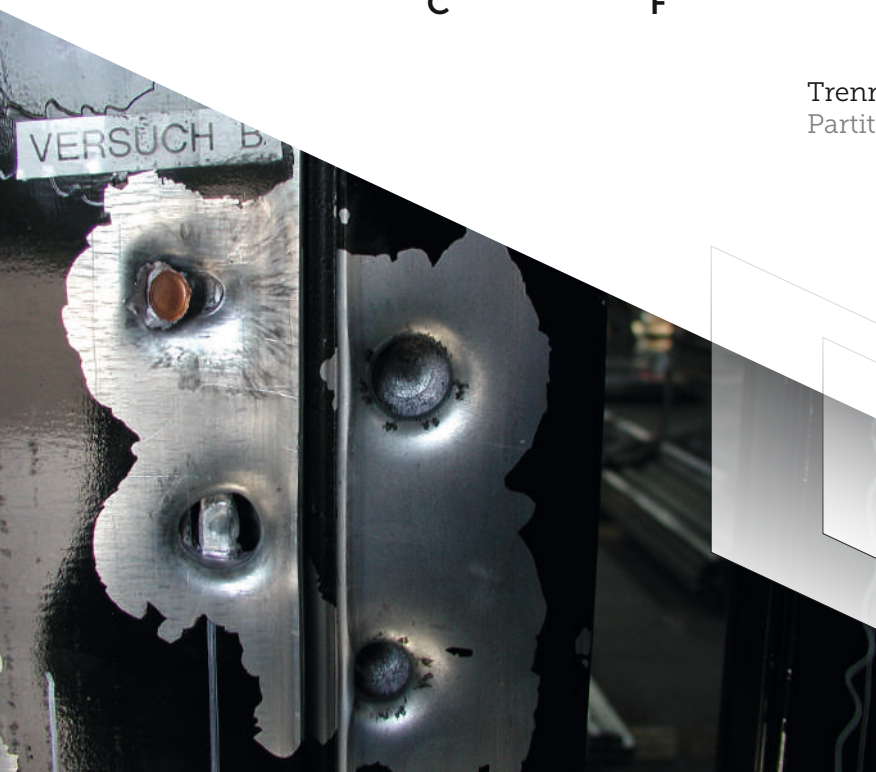

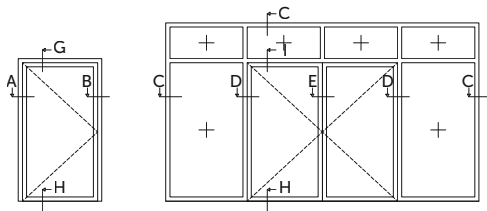

Anschlagtür, einflügelig
Single-action door, single-leaf

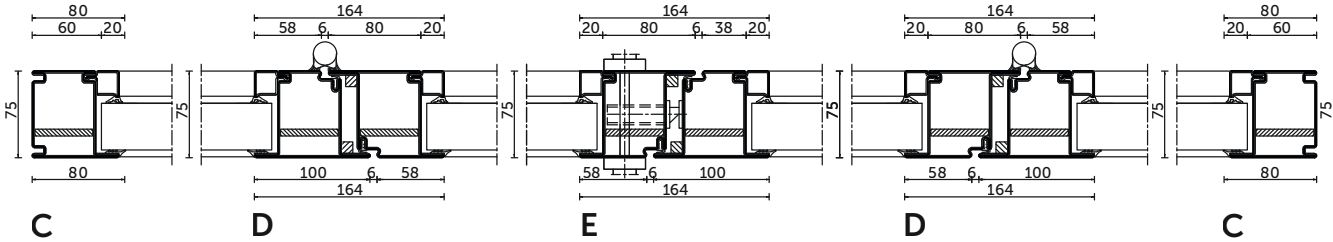
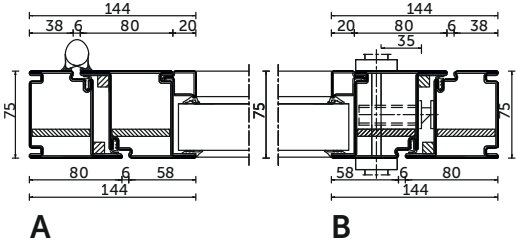

Anschlagtür, zweiflügelig
Single-action door, double-leaf

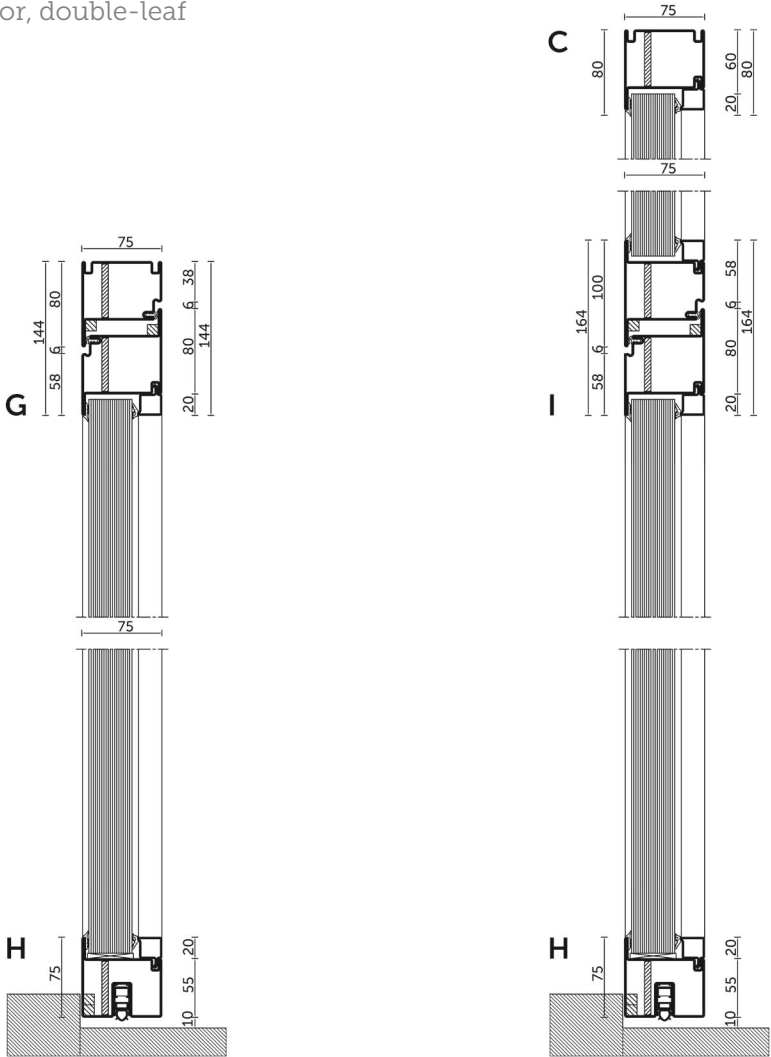

Anschlagtür, nach innen öffnend
Single-action door, inward opening

Anschlagtür mit Oberlicht
Single-action door with top light

rp hermetic 75BR FB6

METALFORM

Durchschusshemmende Türen FB 6, nach innen öffnend

Bullet-resistant doors FB 6, inward opening

Systemübersicht

System overview

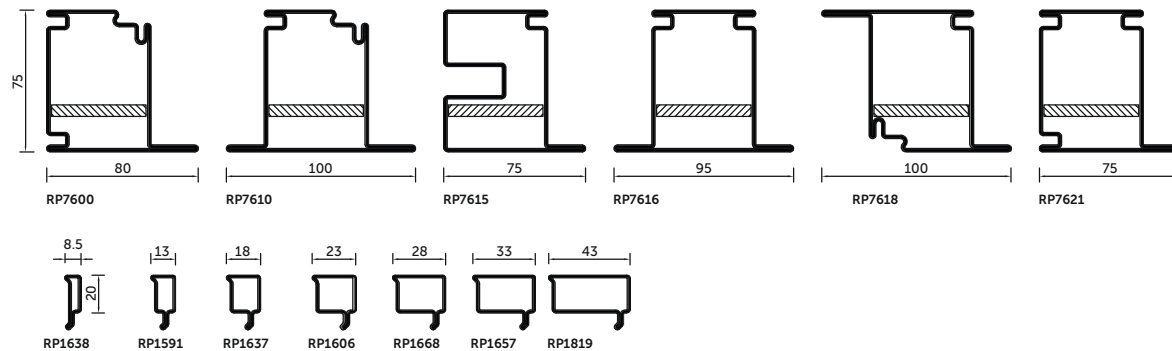

Allgemeines

Die jeweilige Beschussklasse wird bauseits durch das Hinzufügen der erforderlichen Beplankung erreicht.

General information

The respective bullet resistance class is achieved on site by adding the required reinforcement.

Systemschnitte

Sections

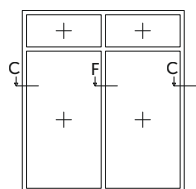

Trennwand
Partition wall

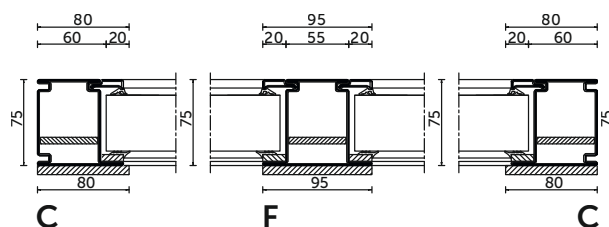

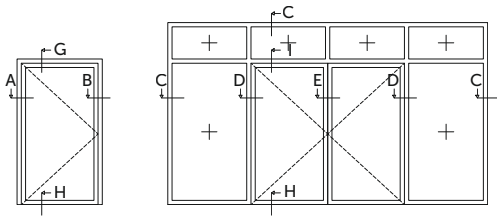

Anschlagtür, einflügelig
Single-action door, single-leaf

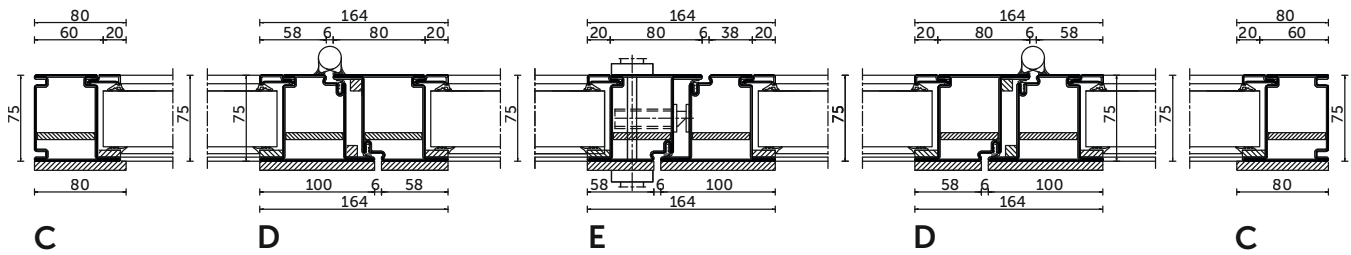
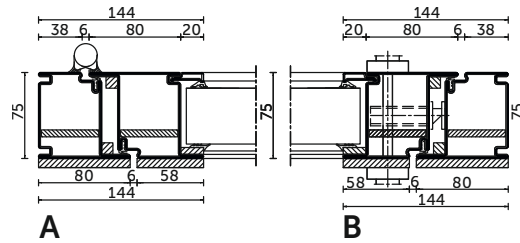

Anschlagtür, zweiflügelig
Single-action door, double-leaf

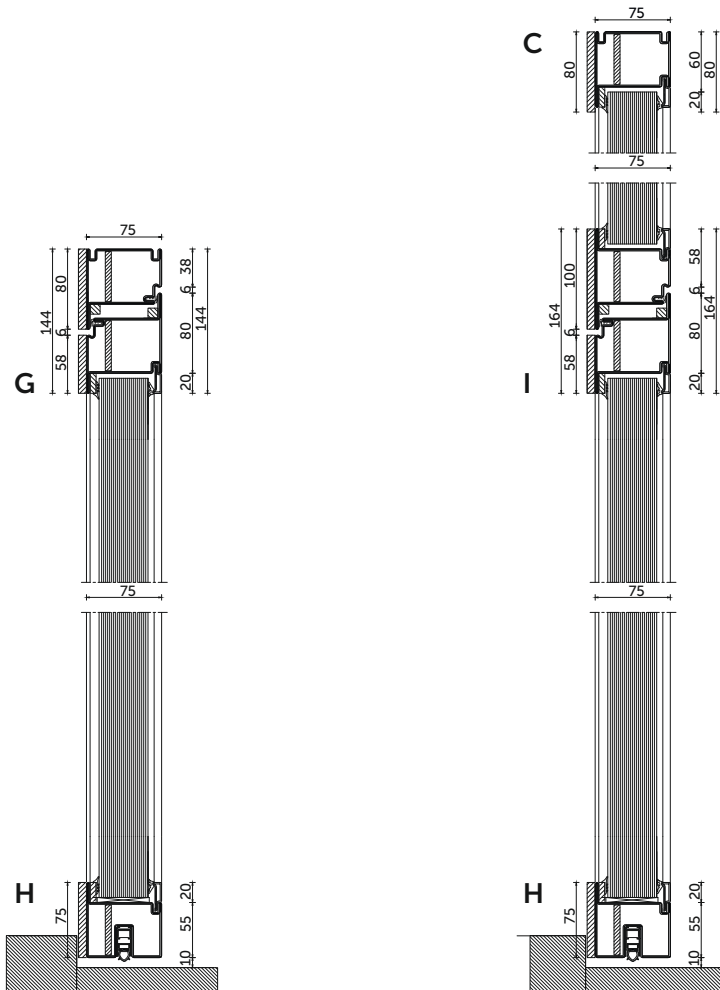

Anschlagtür, nach innen öffnend
Single-action door, inward opening

Anschlagtür mit Oberlicht
Single-action door with top light

rp hermetic 70D

Fluentum Clayallee, Berlin

Architekt / Architect:
Sauerbruch Hutton

METALFORM



METALFORM



METALFORM

MASTERS OF METAL

UNITED KINGDOM

METALFORM

NORWAYMETAL LTD

53 Chelsea Manor Street
London, SW3 5RZ

SALES@METALFORM.UK

+44 20 81298814

GERMANY

METALFORM GMBH

Carl-Zeiss-Ring 15A
85737 Ismaning

SALES@METALFORMGROUP.DE

+49 17663630406

NORWAY

METALFORM AS

Brochmannsveien 2
1950 Rømskog

SALG@METALFORM.NO

+47 401 62 446

METALFORMGROUP

SALES@METALFORMGROUP.COM