



Janisol Arte 66

Thermally insulated slim turn/tilt windows
and fixed lights

METALFORM
JANSEN
Steel Systems

Janisol Arte 66

Slim tilt and turn windows



Tilt and turn windows made from steel profiles

With Janisol Arte 66, Jansen is expanding its range of systems to include an attractive variation. The basic depth of 66 mm enables the use of stronger glass, with a vent height of up to 2300 mm. This makes it possible to have the turn/tilt opening type, even with the special requirements of listed buildings for narrow frames. With the concealed fittings, they meet architects' and developers' demands for a uniform design and clear lines which do not allow any visual interruption. The Euro grooves make it easier for fabricators to install the fittings, while the new glazing bead system facilitates installation of the panes. Fabrication with push-in gasket or dry glazing takes place in the usual way, as with the Janisol and Janisol Arte 2.0 steel profiles – this ensures a high level of process reliability.

Design benefits

- Thermally insulated steel system for windows and fixed glazing
- Basic depth 60/66 mm, window vent 70 mm
- Narrow face widths: Window sash bars 40 mm
Frame including vent from 53 mm
Double vent assembly 76 mm
- Single and double-vent side-hung and turn/tilt windows and bottom-hung windows, inward-opening
- Side-hung and turn/tilt window vents up to 2300 mm height
- Vent weights up to 180 kg
- Infill unit thicknesses from 15 to 39 mm, glazing installed by means of dry or wet glazing
- Suitable for powder and wet paint coating

Fabrication benefits

- Composite technology tested in accordance with EN 14024
- CE classification in accordance with EN 14351-1
- Optimum weldability of the profile frame due to the ZF surface finish
- Mechanical strength tested in accordance with EN 13115
- Impact resistance tested in accordance with EN 13049



Technical data



Single-vent tilt/turn-hung window inward opening

Max. dimensions:
1400×2300 mm (FFB×FFH)
Min. dimensions:
480×470 mm (FFB×FFH)
Max. vent weight: 180 kg

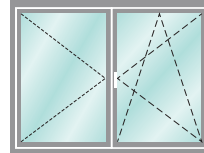

Double-vent side-hung window inward opening

Max. dimensions:
1400×2300 mm (FFB×FFH)
Min. dimensions:
480×470 mm (FFB×FFH)
Max. vent weight: 180 kg

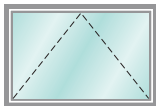

Bottom-hung window inward opening

Max. dimensions:
2300×2300 mm (FFB×FFH)
Min. dimensions:
445×600 mm (FFB×FFH)
Max. vent weight: 80 kg



Janisol Arte 66 profile range

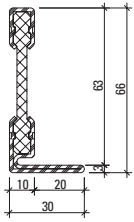

601.630 Z

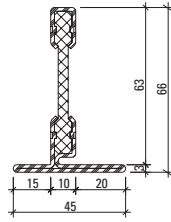

602.630 Z

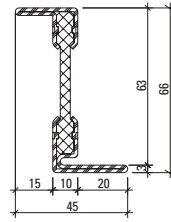

603.630 Z

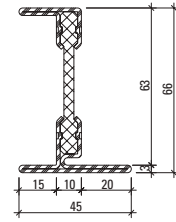

605.630 Z

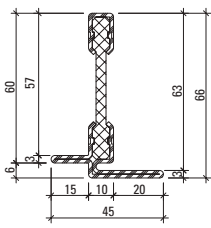

602.631 Z

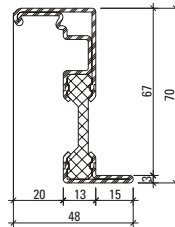

610.900 Z

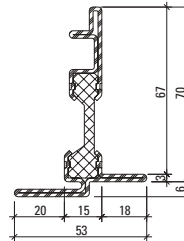

610.901 Z

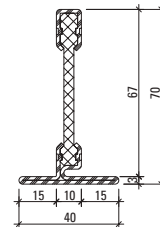

602.611.7 Z

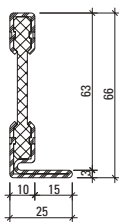

601.612 Z

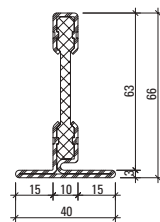

602.613 Z

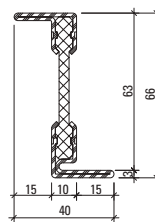
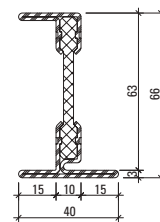
603.612 Z
603.612.01
603.612.09

605.612 Z

Part no.

with Z

= hot-dip galvanised steel

with 01 = Stainless steel, bright, material 1.4401 (AISI 316)

with 09 = Steel KB DOCOL 355W (Corten)

* = on request

Choice of glazing bead for Janisol Arte 66 in steel and aluminium

Aluminium

Steel

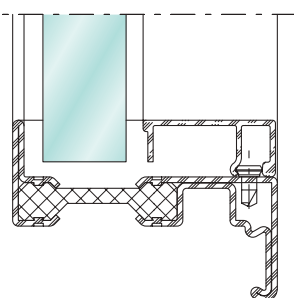
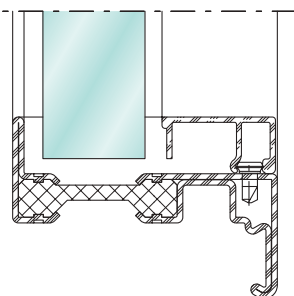
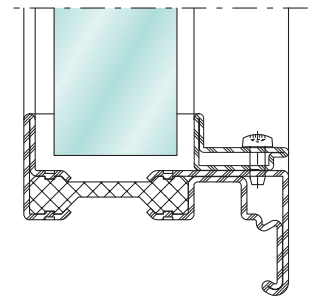
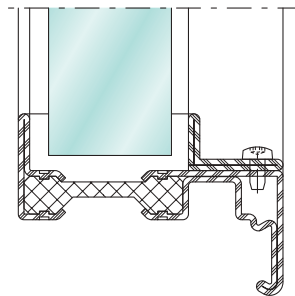
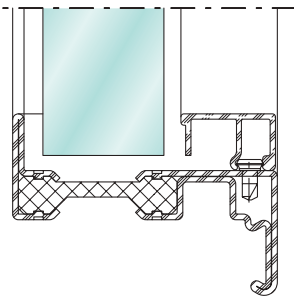
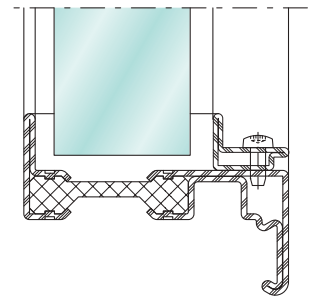
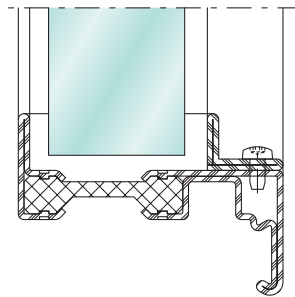
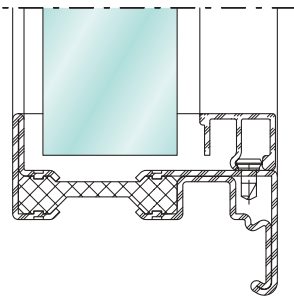
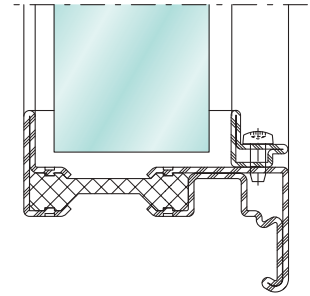
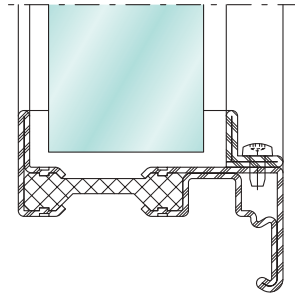
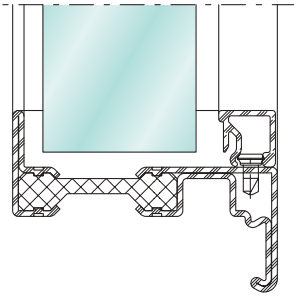

METALFORM

Example of Janisol Arte 66

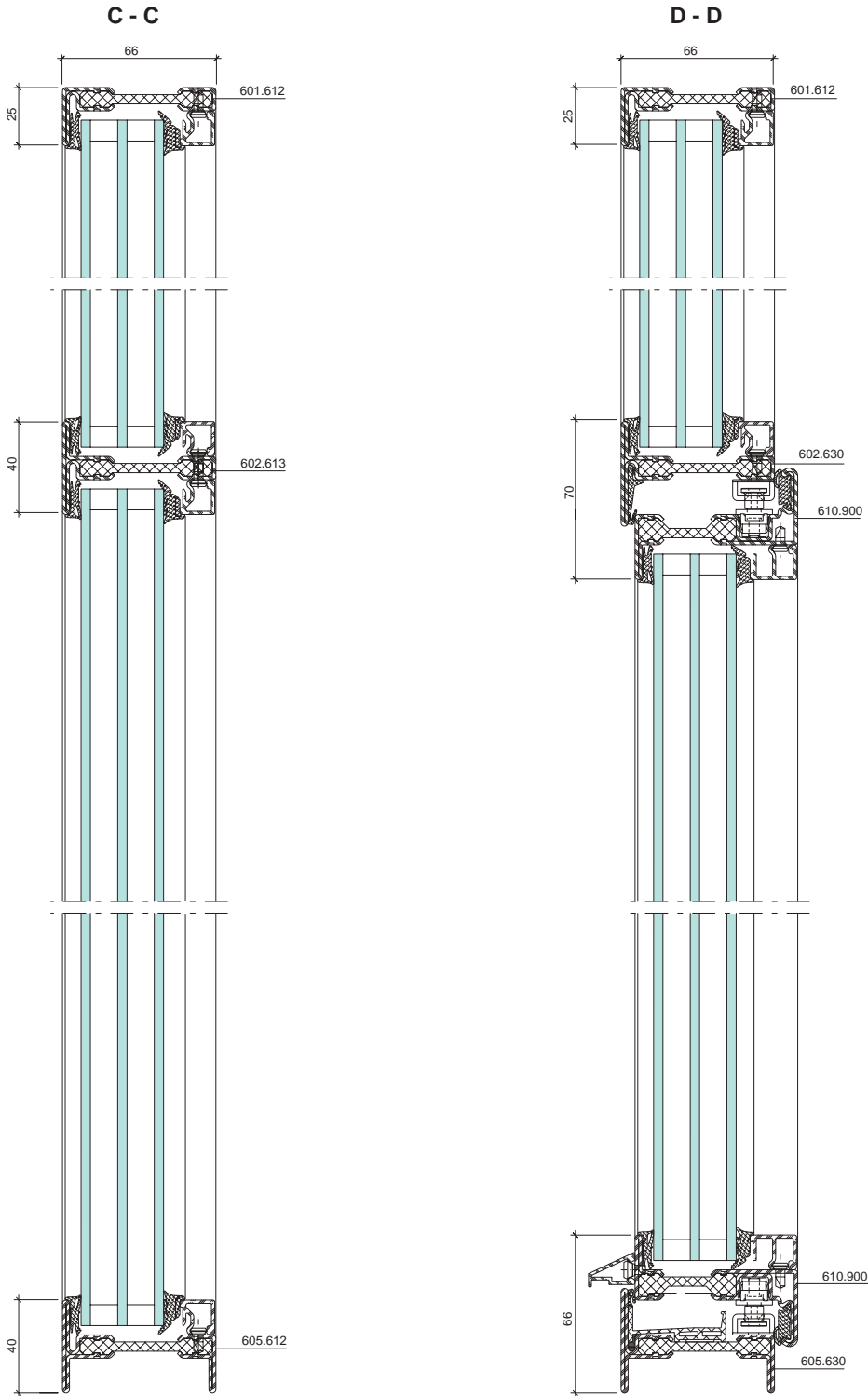

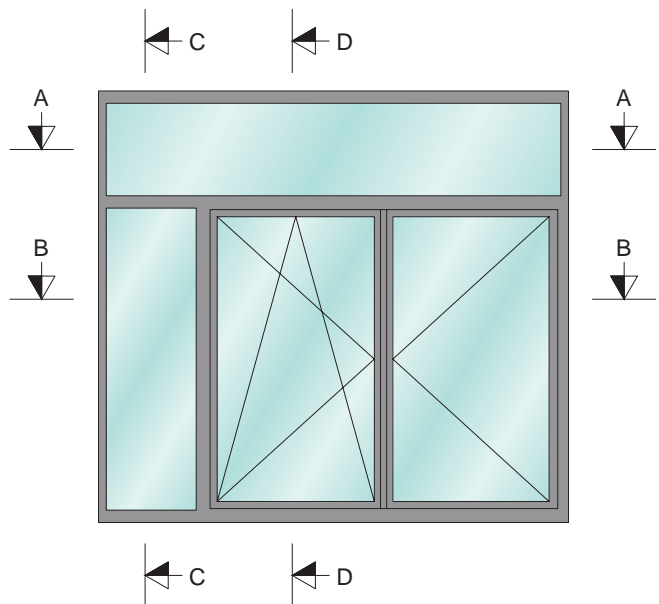
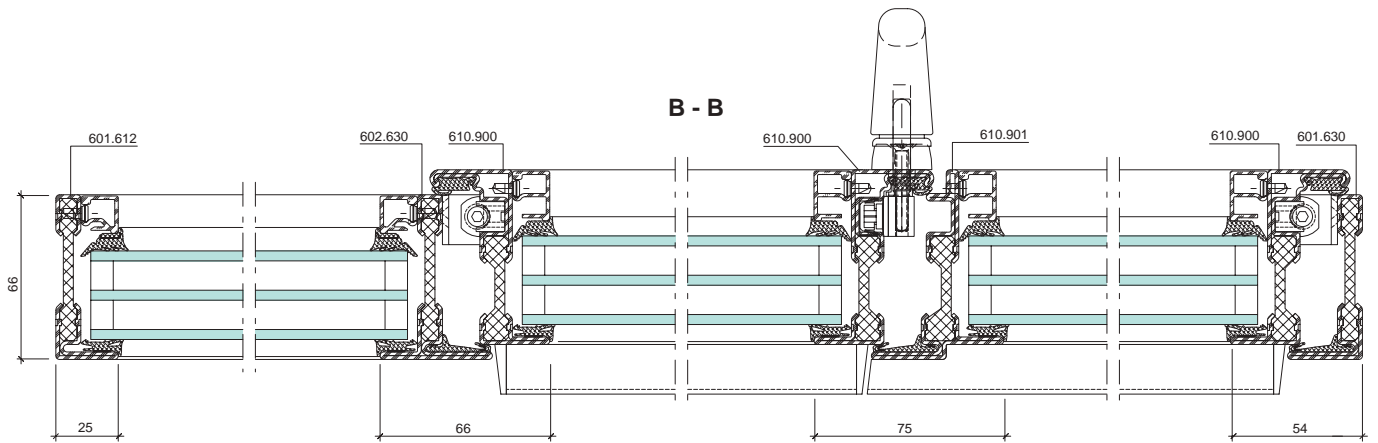
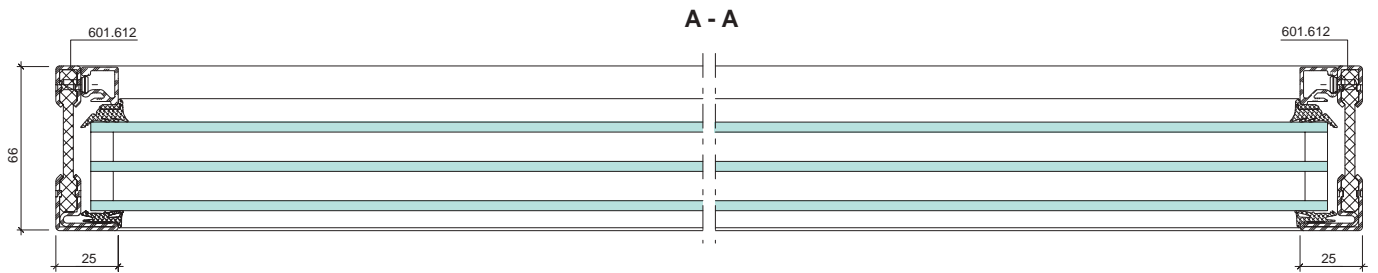

Jansen AG

Steel Systems
Industriestrasse 34
9463 Oberriet
Schweiz
jansen.com

JANSEN
METALFORM

METALFORM

MASTERS OF METAL

UNITED KINGDOM

METALFORM

NORWAYMETAL LTD

53 Chelsea Manor Street
London, SW3 5RZ

SALES@METALFORM.UK

+44 20 81298814

GERMANY

METALFORM GMBH

Carl-Zeiss-Ring 15A
85737 Ismaning

SALES@METALFORMGROUP.DE

+49 17663630406

NORWAY

METALFORM AS

Brochmannsveien 2
1950 Rømskog

SALG@METALFORM.NO

+47 401 62 446

METALFORMGROUP

SALES@METALFORMGROUP.COM