

Ausgeführte Objekte

Wärmegeämmte Fassadensysteme

Objets réalisés

Systèmes de façades à rupture de pont thermique

Completed projects

Thermally insulated façade systems

Hinweis

Remarque

Notice

Grafische Planungsdaten wie z.B. Anwendungsbeispiele, Konstruktionsdetails, Anschlüsse am Bau, die in unseren physischen oder elektronischen Dokumentationsunterlagen enthalten sind, sind schematische Darstellungen. Gleiches gilt für digitale Medien wie CAD Dateien oder BIM Modelle.

Sie sollen den ausführenden Metallbauer und/oder Fachplaner bei der Planung und Ausführung eines Projektes unterstützen. Sie sind im konkreten Anwendungsfall durch den ausführenden Metallbauer und/oder Fachplaner auf die Verwendbarkeit im konkreten betroffenen Projekt hinsichtlich rechtlichen/regulatorischen aber auch technischen objektspezifischen Anforderungen zu überprüfen und ggfs. eigenverantwortlich anzupassen.

Bei der Überprüfung, der spezifischen Planung und der Umsetzung sind die objektspezifischen Rahmenbedingungen (Material der Bausubstanz, Dimension des Einbauelements, Farbe, Exposition, Lasteinwirkung, etc.) sowie der geltende Stand der Technik einschliesslich aller anwendbaren Normen und technischen Richtlinien eigenverantwortlich zu beachten.

Falls das vorliegende Dokument Differenzen zur aktuellen deutschen Version (Artikel Nr. K1214205) aufweist, gilt in jedem Fall der deutsche Originaltext in der jeweils geltenden Fassung im Jansen Docu Center.

Alle Ausführungen dieser Dokumentation haben wir sorgfältig und nach bestem Wissen zusammengestellt. Wir können aber keine Verantwortung für die Benutzung der vermittelten Vorschläge und Daten übernehmen. Wir behalten uns technische Änderungen ohne Vorankündigung vor.

Les données de planification graphiques, comme les exemples d'application, détails de construction et raccordements au bâtiment, fournies dans notre documentation physique et numérique sont des représentations schématiques. Il en va de même pour les médias numériques comme les fichiers CAD ou modèles BIM.

Leur but est de faciliter la planification et réalisation d'un projet par les constructeurs métalliques et/ou concepteurs. Concrètement, elles doivent être vérifiées par le constructeur métallique et/ou le concepteur et, le cas échéant, modifiées de son propre chef pour s'assurer qu'elles concordent avec le projet concerné et qu'elles répondent aux exigences techniques spécifiques ainsi qu'aux dispositions légales et réglementaires.

Lors de la vérification, de la planification spécifique et de la mise en œuvre, il y a lieu de tenir compte des conditions spécifiques à l'objet (matériaux du bâtiment, dimension de l'élément d'insert, couleur, exposition, effet de charge, etc.) ainsi que de l'état actuel de la technique, y compris toutes les normes et directives techniques applicables.

En cas de divergence entre le présent document et la version allemande (no d'article K1214205), c'est dans tous les cas le texte original allemand qui prévaut dans sa version actuelle disponible dans le Jansen Docu Center.

Nous avons apporté le plus grand soin à l'élaboration de cette documentation. Cependant, nous déclinons toute responsabilité pour l'utilisation faite de nos propositions et de nos données.

Nous nous réservons le droit de procéder à des modifications techniques sans préavis.

Graphical planning data such as application examples, construction details, connections on site that are contained in our physical or electronic documentation components are schematic representations. The same applies to digital media such as CAD files or BIM models.

They are intended to support the metal worker and/or design engineer in planning and executing projects. In the specific case of application they are to be checked by the metal worker and/or design engineer in terms of their usability in the specific project concerned with regard to legal/regulatory and technical property-specific requirements and adjusted if necessary at the latter's own responsibility. The property-specific underlying conditions (construction material, dimensions of installation element, colour, exposure, load effect etc.) and current state of the art including all applicable norms and technical guidelines are to be taken into consideration at the metal worker and/or design engineer's own responsibility during the review, specific planning and implementation.

If there are any differences between this document and the current German version (item number K1214205), the latest version of the original German text in the Jansen Docu Center shall prevail.

All the information contained in this documentation is given to the best of our knowledge and ability. However, we decline all responsibility for the use made of these suggestions and data.

We reserve the right to effect technical modifications without prior warning.

Inhaltsverzeichnis

Sommaire

Content



3 Wissenschaftszentrum Kopernikus, Warschau/PL



4 Schloss Novy Svetlov, Bojkovice/CZ



5 Hotel Magyar Király, Székesfehérvár/HU



6 Theater- und Konzerthaus Kilden, Kristiansand/NO



8 Museum für moderne Kunst, Zagreb/HR



10 Museum für Kunst und Kulturgeschichte Altona, Hamburg-Altona/DE



11 TransPort (Flughafen Schiphol), Amsterdam/NL



12 Büro- und Geschäftshaus «Hillsite», Schwalbach am Taunus/DE



14 Zentralarchiv EDF, Bure/FR



16 Gemeindehaus, Ruidellots de la Selva/ES



17 Hauptbahnhof, Köln/DE



18 Universität Lausanne «Géopolis», Lausanne/CH



20 Jansen AG, Campus, Oberriet/CH



22 Bildungsforum, Potsdam/DE



24 Besucherzentrum «Alte Wasserzentrale», Pietra Neamt/RO



26 Hotel Novi Spa, Novi Vinodolski/HR



27 Solvias AG, Büro- und Lagergebäude, Kaiseraugst/CH



28 Médiathèque, Pau/FR



30 «Mumuth» Haus für Musik & Musiktheater der Kunstuniversität, Graz/AT



32 Centre Pompidou, Metz/FR



33 Alters- und Pflegeheim, Burgdorf/CH



34 Drents Museum, Assen/NL



36 Akustik-Tunnels, Warschau/PL



38 Jin Ji Hu Kempinski Hotel, Suzhou/CN



39 Historisches Museum, Kharkov/UA



40 Kunstgebäude, Stuttgart/DE



42 3-Feldsporthalle, Ingelfingen/DE



44 Musikkonservatorium, Bilbao/ES



45 Landesberufsschule, Mureck/AT



46 Hafencity Schule, Hamburg/DE



48 Drehrestaurant
«Hoher Kasten»,
Brülisau/CH



50 Hauptbahnhof
«Rotterdam Centraal»,
Rotterdam/NL



52 IGuzzini
Illuminazione,
Barcelona/ES



54 «Erasmus»
Studenten-Pavillon,
Rotterdam/NL



56 Hochschule
«Anstalt für
angewandte
Wissenschaften»,
Dessau/DE



57 Justizgebäude,
Würzburg/DE



58 Halle M, Jansen AG,
Oberriet/CH



60 Vogtlandhalle
(Stadthalle),
Greiz/DE



62 Ausbau Messehalle
BEA Expo,
Bern/CH



63 MAN Nutzfahrzeuge,
Werkserweiterung,
München/DE



64 Museumsquartier,
Den Bosch/NL



66 Werkhalle
Glas Trösch,
St.Gallen/CH



67 Voentorg Center,
Moskau/R



68 Neue Messehalle
(Kielce Trade Fairs),
Kielce/PL

Ausgeführte Objekte Objets réalisés Completed projects

JANSEN

Objekt:

Wissenschaftszentrum Kopernikus,
Centrum Nauki Kopernik, Warschau/PL

System:

VISS TVS, VISS SG, VISS Fire,
Janisol 2 EI30, Janisol SG

Architekt:

RAR-2 Laboratorium Architektury
Jan Kubec, Ruda Śląska/PL

Objet:

Centre de recherche Copernique,
Centrum Nauki Kopernik, Varsovie/PL

Système:

VISS TVS, VISS SG, VISS Fire,
Janisol 2 EI30, Janisol SG

Architecte:

RAR-2 Laboratorium Architektury
Jan Kubec, Ruda Śląska/PL

Project:

Copernicus Science Centre,
Centrum Nauki Kopernik, Warsaw/PL

System:

VISS TVS, VISS SG, VISS Fire,
Janisol 2 EI30, Janisol SG

Architect:

RAR-2 Laboratorium Architektury
Jan Kubec, Ruda Śląska/PL



Ausgeführte Objekte
Objets réalisés
Completed projects



Objekt:

Schloss Novy Svetlov, Bojkovice/CZ

System:

VISS SG, VISS TVS (schräg)

Architekt:

Stavos s.r.o., Příbram/CZ

Objet:

Château Novy Svetlov, Bojkovice/CZ

Système:

VISS SG, VISS TVS (oblique)

Architecte:

Stavos s.r.o., Příbram/CZ

Project:

Novy Svetlov castle, Bojkovice/CZ

System:

VISS SG, VISS TVS (sloping)

Architect:

Stavos s.r.o., Příbram/CZ



Objekt:

Hotel Magyar Király,
Székesfehérvár/HU

System:

VISS TVS (schräg)

Architekt:

Szendro Epitesz Studio, Budapest/HU

Objet:

Hôtel Magyar Király,
Székesfehérvár/HU

Systeme:

VISS TVS (oblique)

Architecte:

Szendro Epitesz Studio, Budapest/HU

Project:

Hotel Magyar Király, Székesfehérvár/
HU

System:

VISS TVS (sloping)

Architect:

Szendro Epitesz Studio, Budapest/HU

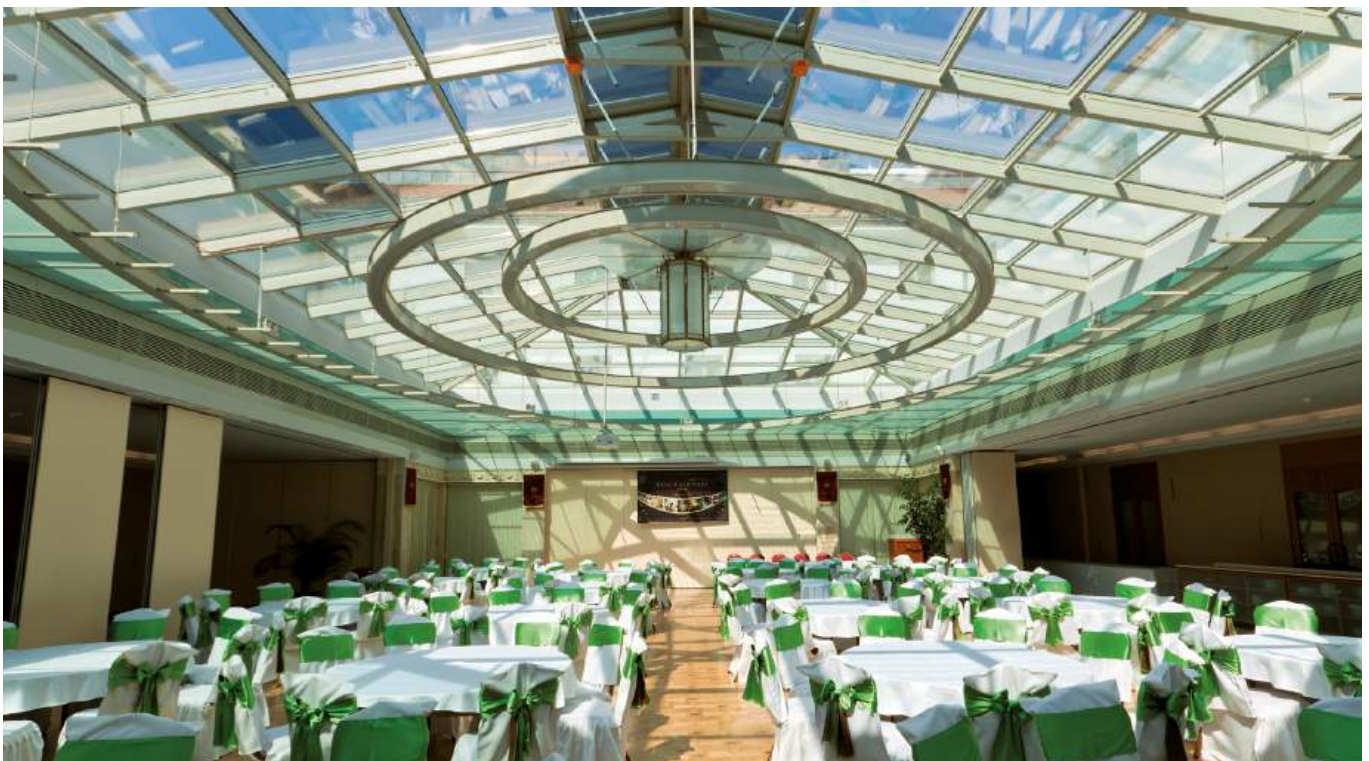

Ausgeführte Objekte

Objets réalisés

Completed projects

Objekt:

Theater- und Konzerthaus Kilden,
Kristiansand/NO

System:

VISS I_xtra

Architekt:

ALA Architects, Helsinki/SF

Objet:

Maison du théâtre et des concerts
Kilden, Kristiansand/NO

Système:

VISS I_xtra

Architecte:

ALA Architects, Helsinki/SF

Project:

Kilden Performing Arts Centre,
Kristiansand/NO

System:

VISS I_xtra

Architect:

ALA Architects, Helsinki/SF



Fotos: Jiri Havran, Oslo

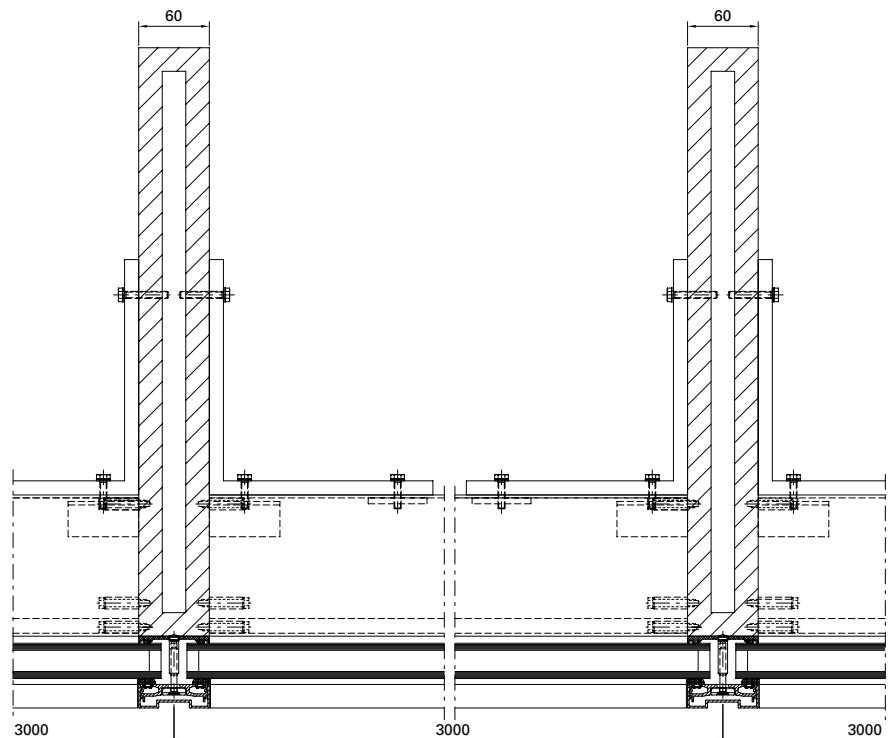
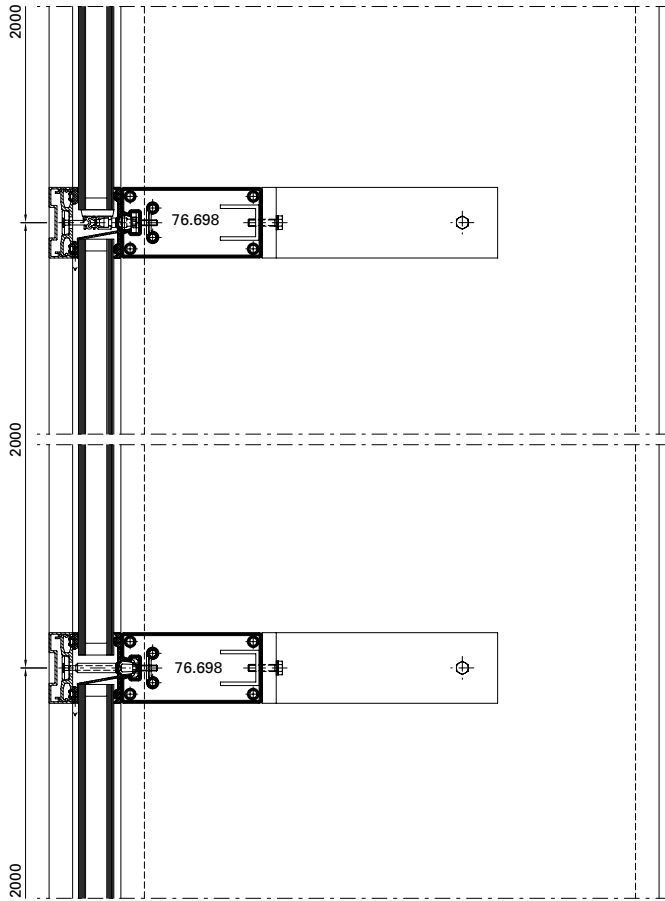

Ausgeführte Objekte

Objets réalisés

Completed projects

Objekt:

Museum für moderne Kunst, Zagreb/
HR

System:

VISS SG

Architekt:

Igor Franić Architekturstudio SZA,
Zagreb/HR

Objet:

Musée de l'art contemporain,
Zagreb/HR

Système:

VISS SG

Architecte:

Igor Franić Architekturstudio SZA,
Zagreb/HR

Project:

Museum of Contemporary Art, Zagreb/
HR

System:

VISS SG

Architect:

Igor Franić Architekturstudio SZA,
Zagreb/HR





Ausgeführte Objekte
Objets réalisés
Completed projects



Objekt:

Museum für Kunst und
Kulturgeschichte Altona,
Hamburg-Altona/DE

System:

VISS I_xtra, Janisol 2 EI30

Architekt:

Störmer Murphy and Partners GbR,
Hamburg/DE

Objet:

Musée de l'art et de l'histoire
de la civilisation Altona,
Hambourg-Altona/DE

Système:

VISS I_xtra, Janisol 2 EI30

Architecte:

Störmer Murphy and Partners GbR,
Hambourg/DE

Project:

Altona Museum of Art and
Cultural History Altona,
Hamburg-Altona/DE

System:

VISS I_xtra, Janisol 2 EI30

Architect:

Störmer Murphy and Partners GbR,
Hamburg/DE



Fotos: Jochen Helle, Dortmund

Objekt:

TransPort (Flughafen Schiphol),
Amsterdam/NL

System:

VISS Basic TVS Fire, VISS TVS

Architekt:

Architectenbureau Paul de Ruiter,
Amsterdam/NL

Objet:

TransPort (aéroport Schiphol),
Amsterdam/NL

Système:

VISS Basic TVS Fire, VISS TVS

Architecte:

Architectenbureau Paul de Ruiter,
Amsterdam/NL

Project:

TransPort (Schiphol airport),
Amsterdam/NL

System:

VISS Basic TVS Fire, VISS TVS

Architect:

Architectenbureau Paul de Ruiter,
Amsterdam/NL



Ausgeführte Objekte

Objets réalisés

Completed projects

Objekt:

Büro- und Geschäftshaus «Hillsite»,
Schwalbach am Taunus/DE

System:

VISS Semi SG

Architekt:

Meixner-Schlüter-Wendt Architekten,
Frankfurt am Main/DE

Objet:

Immeuble de bureaux et de commerce
«Hillsite», Schwalbach am Taunus/DE

Système:

VISS Semi SG

Architecte:

Meixner-Schlüter-Wendt Architekten,
Frankfurt am Main/DE

Project:

«Hillsite» office complex,
Schwalbach am Taunus/DE

System:

VISS Semi SG

Architect:

Meixner-Schlüter-Wendt Architekten,
Frankfurt am Main/DE

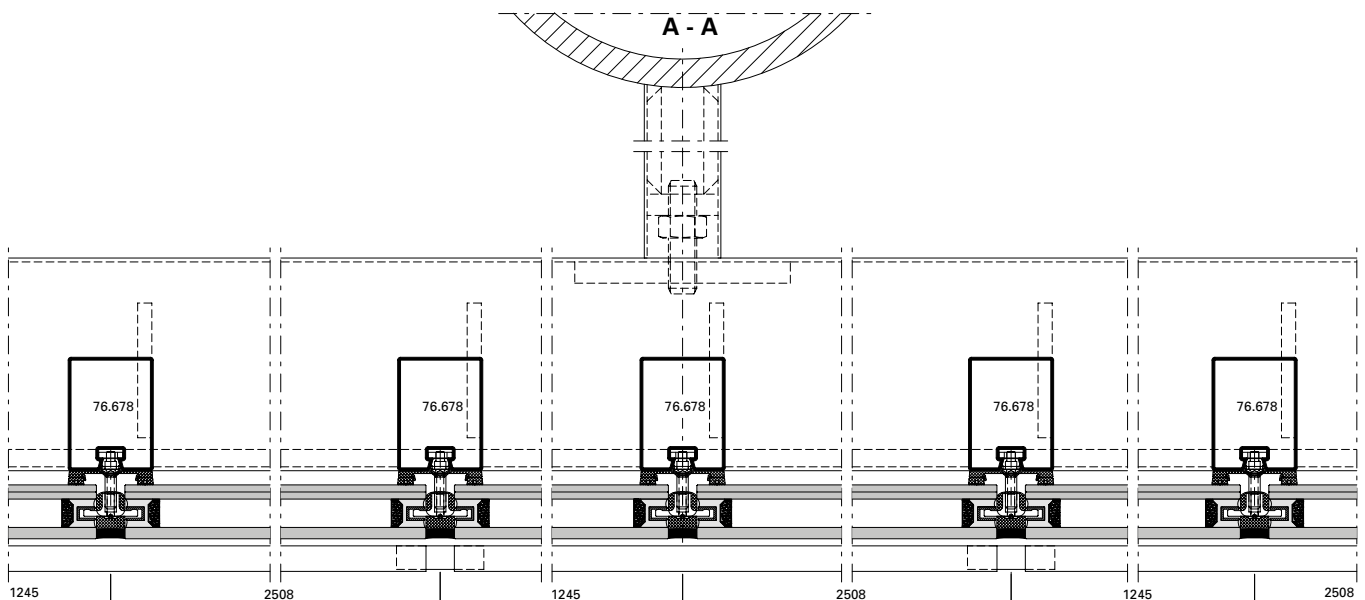

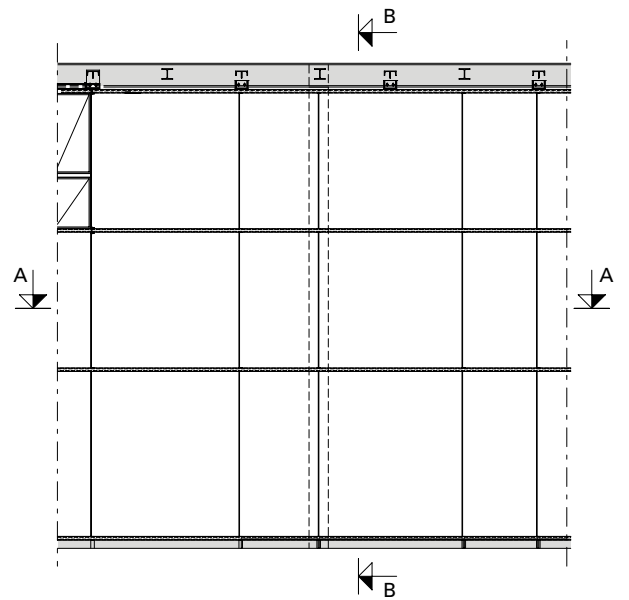
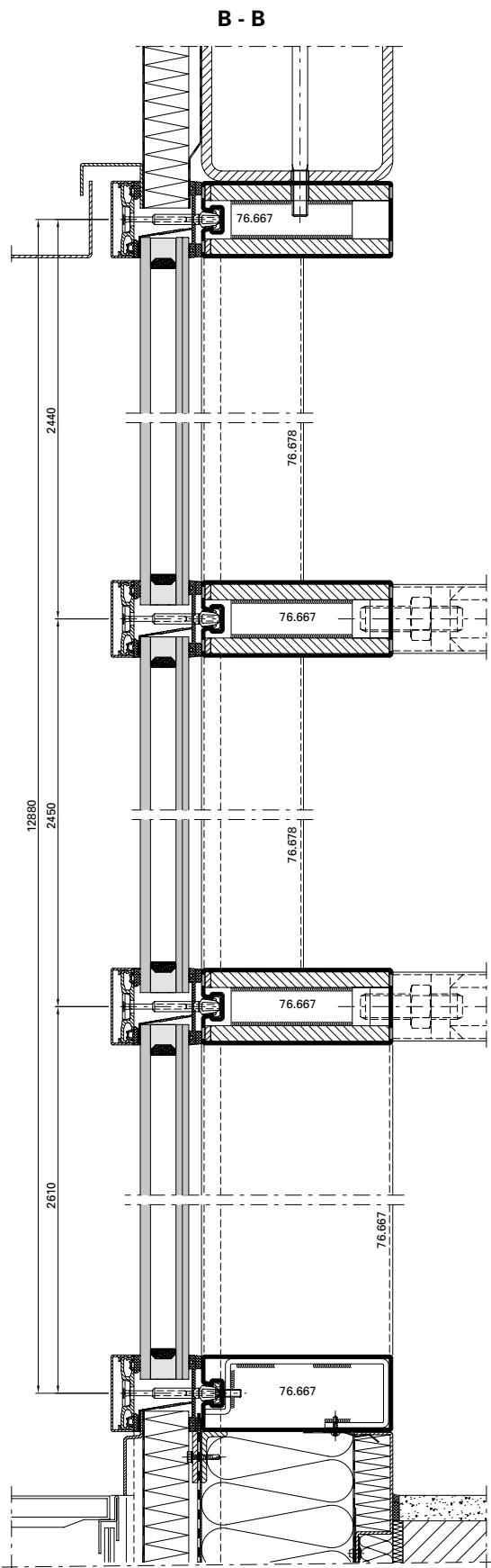

Ausgeführte Objekte

Objets réalisés

Completed projects

Objekt:

Zentralarchiv EDF, Bure/FR

System:

VISS TVS, Janisol Türen Edelstahl

Architekt:

LAN (Local Architecture Network), Paris/FR

Objet:

Centre d'archives EDF, Bure/FR

Système:

VISS TVS, portes Janisol acier Inox

Architecte:

LAN (Local Architecture Network), Paris/FR

Project:

Central archive EDF, Bure/FR

System:

VISS TVS, Janisol doors stainless steel

Architect:

LAN (Local Architecture Network), Paris/FR

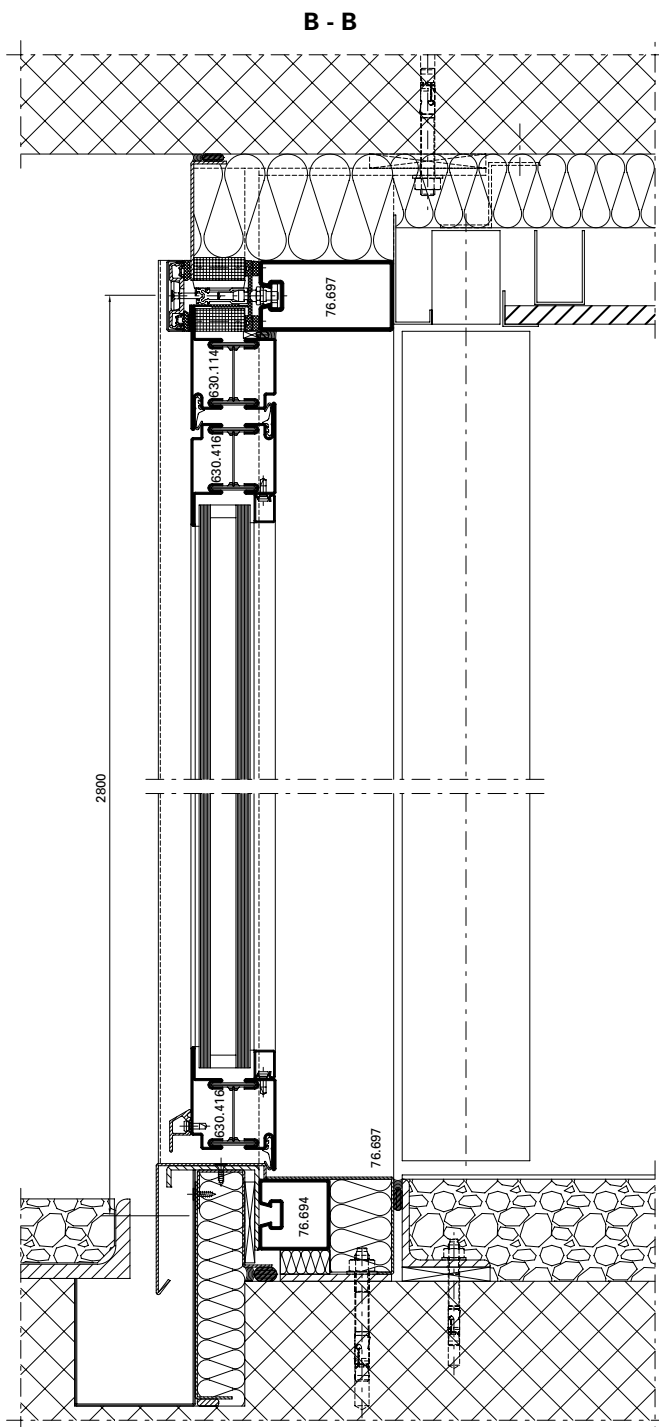

A - A

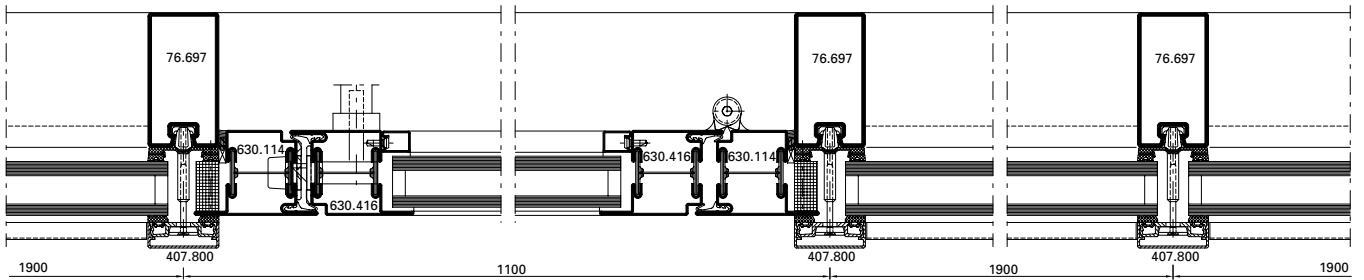

B

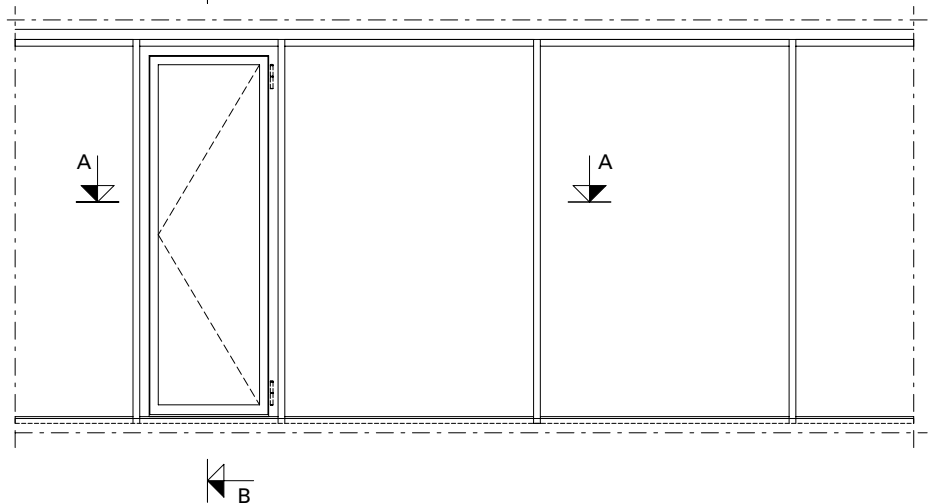

Ausgeführte Objekte

Objets réalisés

Completed projects

Objekt:

Gemeindehaus,
Ruidellots de la Selva/ES

System:

VISS TVS

Architekt:

Pla & Padrosa S.A., Girona/ES

Objet:

Hôtel de ville,
Ruidellots de la Selva/ES

Système:

VISS TVS

Architecte:

Pla & Padrosa S.A., Girona/ES

Project:

Town hall,
Ruidellots de la Selva/ES

System:

VISS TVS

Architect:

Pla & Padrosa S.A., Girona/ES

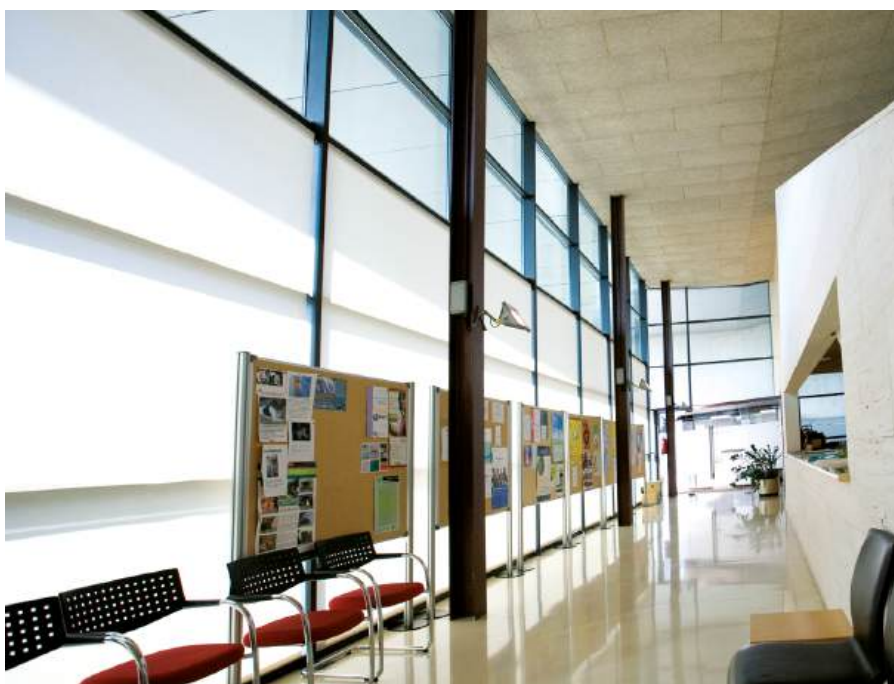

Objekt:

Hauptbahnhof, Köln/DE

System:

VISS TV, Jansen-Economy 50 Türen,
Janisol Türen Edelstahl

Architekt:

Kopka und Theil Architekten,
Dortmund/DE

Objet:

Gare centrale, Cologne/DE

Système:

VISS TV, portes Jansen-Economy 50,
portes Janisol acier Inox

Architecte:

Kopka und Theil Architekten,
Dortmund/DE

Project:

Central station, Cologne/DE

System:

VISS TV, Jansen-Economy 50 doors,
Janisol stainless steel doors

Architect:

Kopka und Theil Architekten,
Dortmund/DE



Fotos: Jochen Helle, Dortmund



Ausgeführte Objekte Objets réalisés Completed projects

Objekt:

UNIL, Universität Lausanne «Géopolis»,
Lausanne/CH

System:

VISS Fire, VISS TV, Janisol 2 EI30

Architekt:

Itten + Brechbühl Architekten,
Büro Lausanne, Lausanne/CH

Objet:

UNIL, Université de Lausanne
«Géopolis», Lausanne/CH

Système:

VISS Fire, VISS TV, Janisol 2 EI30

Architecte:

Itten + Brechbühl Architekten,
Büro Lausanne, Lausanne/CH

Project:

UNIL, University of Lausanne
«Géopolis», Lausanne/CH

System:

VISS Fire, VISS TV, Janisol 2 EI30

Architect:

Itten + Brechbühl Architekten,
Büro Lausanne, Lausanne/CH

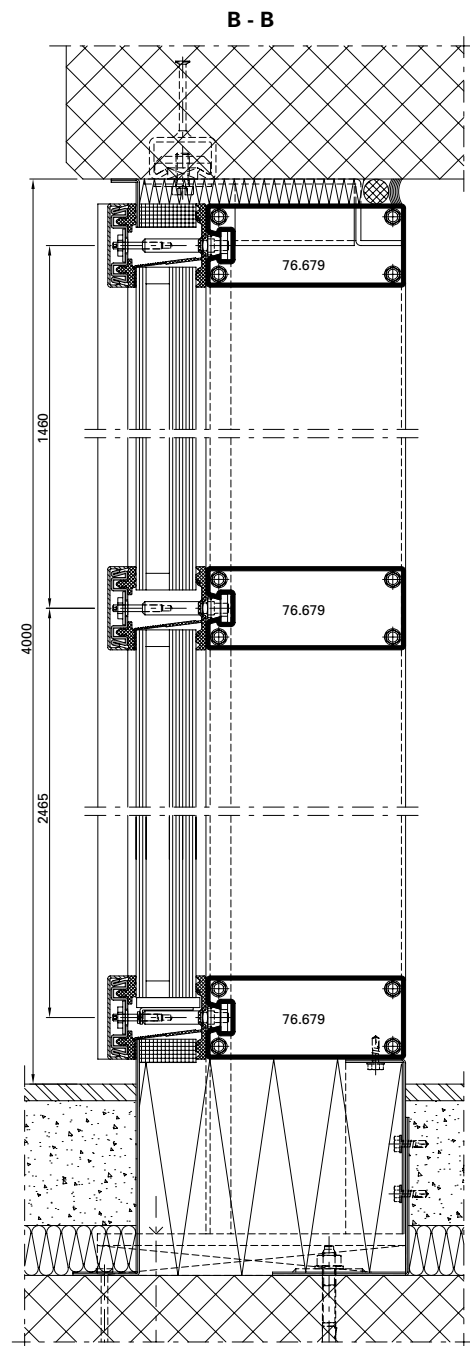

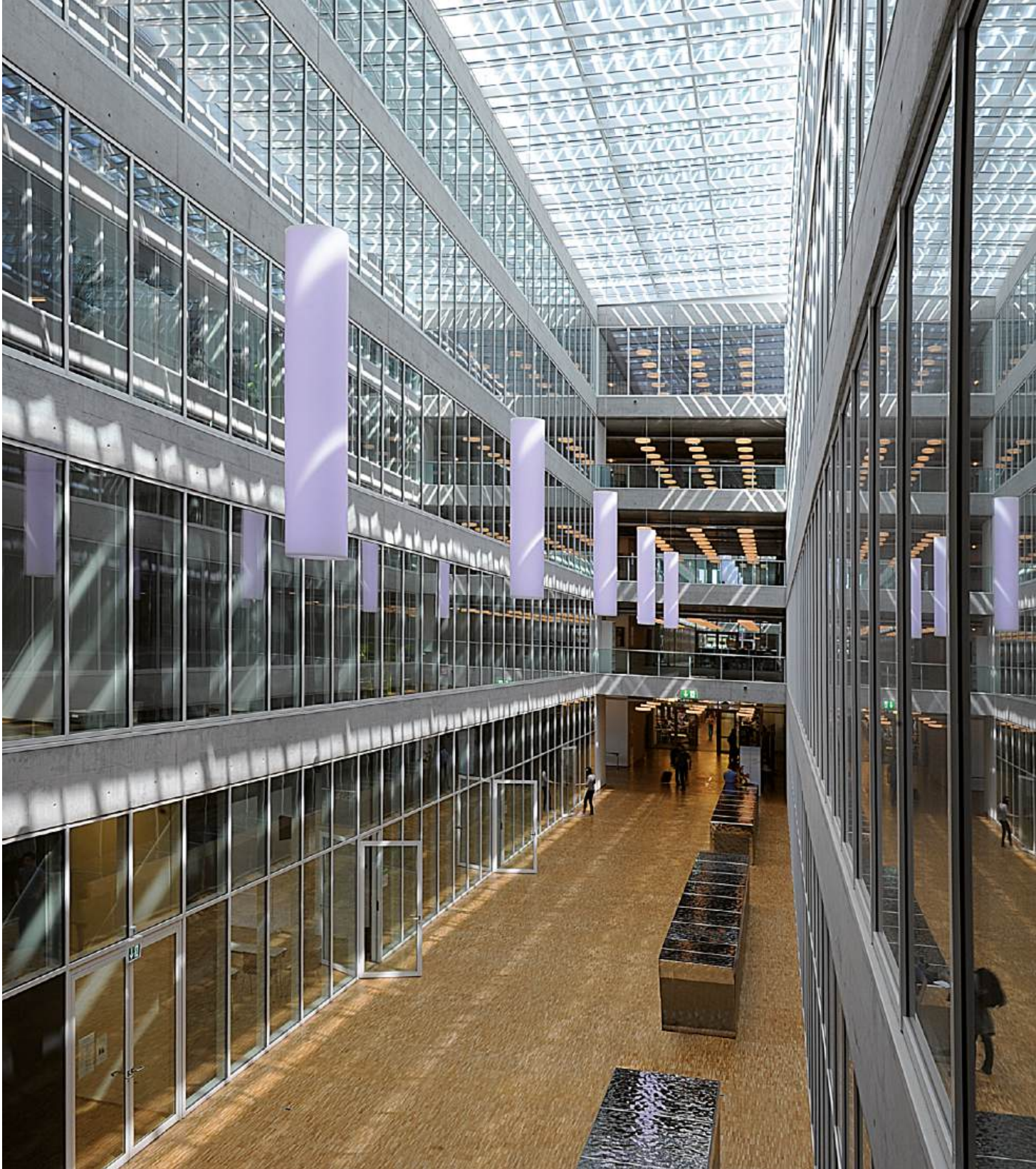

A - A

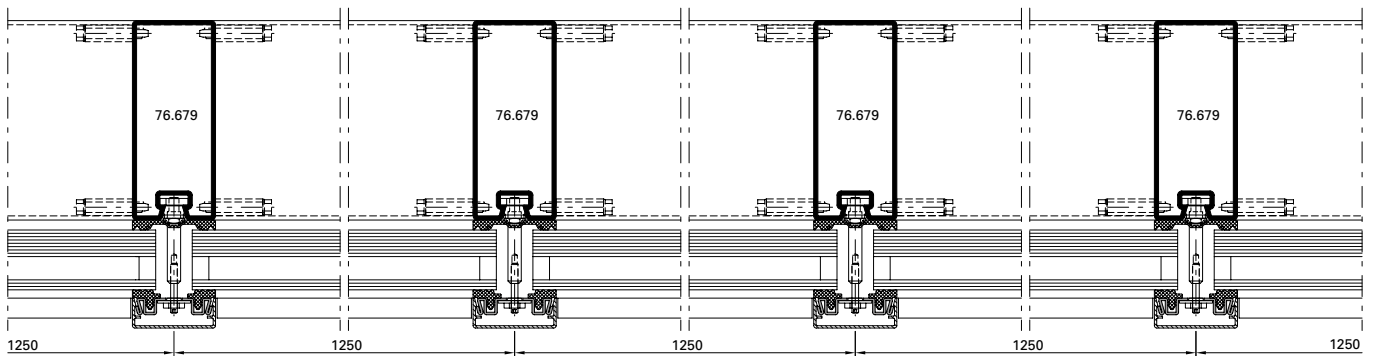

Ausgeführte Objekte

Objets réalisés

Completed projects

Objekt:

Jansen AG, Campus, Oberriet/CH

System:

VISS SG

Architekt:

Davide Macullo Architects, Lugano/CH

Objet:

Jansen AG, Campus, Oberriet/CH

Système:

VISS SG

Architecte:

Davide Macullo Architects, Lugano/CH

Project:

Jansen AG, Campus, Oberriet/CH

System:

VISS SG

Architect:

Davide Macullo Architects, Lugano/CH

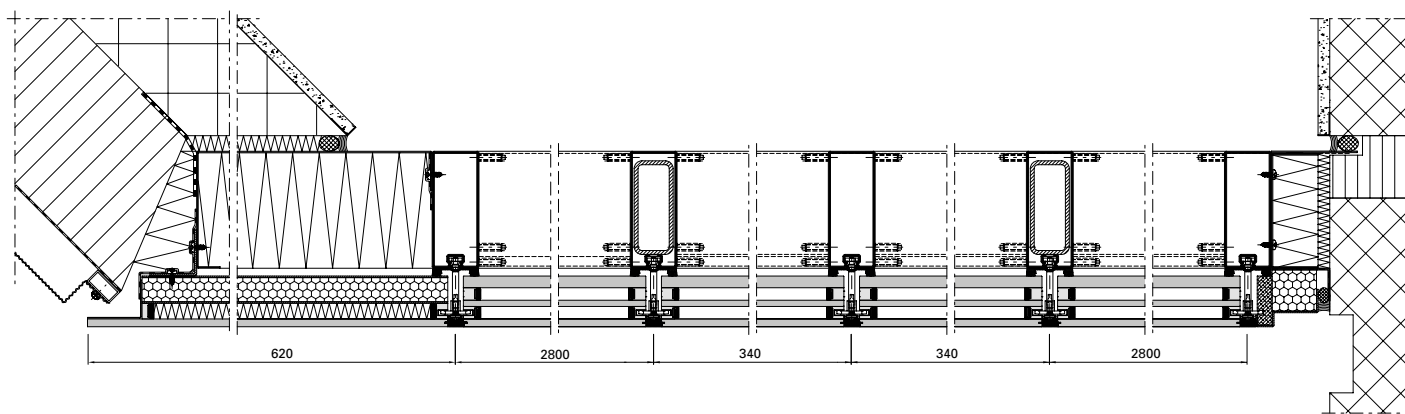

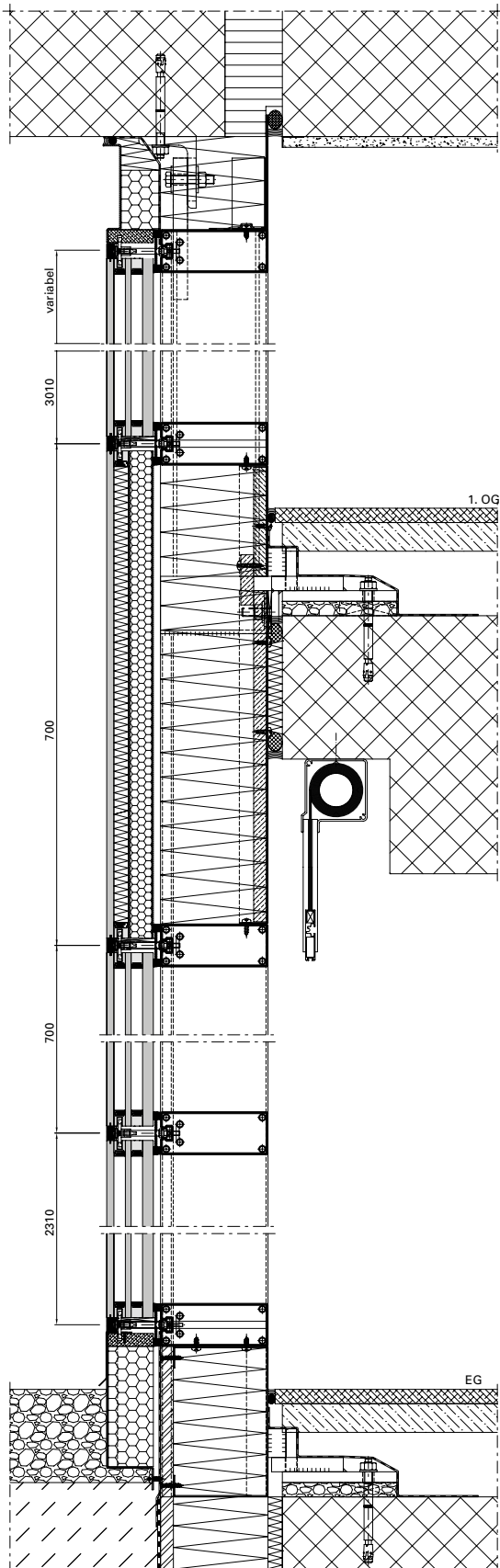

Ausgeführte Objekte

Objets réalisés

Completed projects

Objekt:

Bildungsforum, Potsdam/DE

System:

VISS TVS HI, VISS Fire

Architekt:

Reiner Becker Architekten BDA, Berlin/
DE

Objet:

Forum de formation, Potsdam/DE

Système:

VISS TVS HI, VISS Fire

Architecte:

Reiner Becker Architekten BDA, Berlin/
DE

Project:

Education forum, Potsdam/DE

System:

VISS TVS HI, VISS Fire

Architect:

Reiner Becker Architekten BDA, Berlin/
DE





Fotos: Stephan Falk, Berlin



Ausgeführte Objekte

Objets réalisés

Completed projects

Objekt:

Besucherzentrum «Alte Wasserzentrale», Pietra Neamt/RO

System:

VISS TVS

Architekt:

ZIP & BDX Studio, Marius Calin, Bukarest/RO

Objet:

Centre de visiteurs «ancienne centrale des eaux», Pietra Neamt/RO

Système:

VISS TVS

Architecte:

ZIP & BDX Studio, Marius Calin, Bukarest/RO

Project:

Visitor centre «old water station», Pietra Neamt/RO

System:

VISS TVS

Architect:

ZIP & BDX Studio, Marius Calin, Bukarest/RO

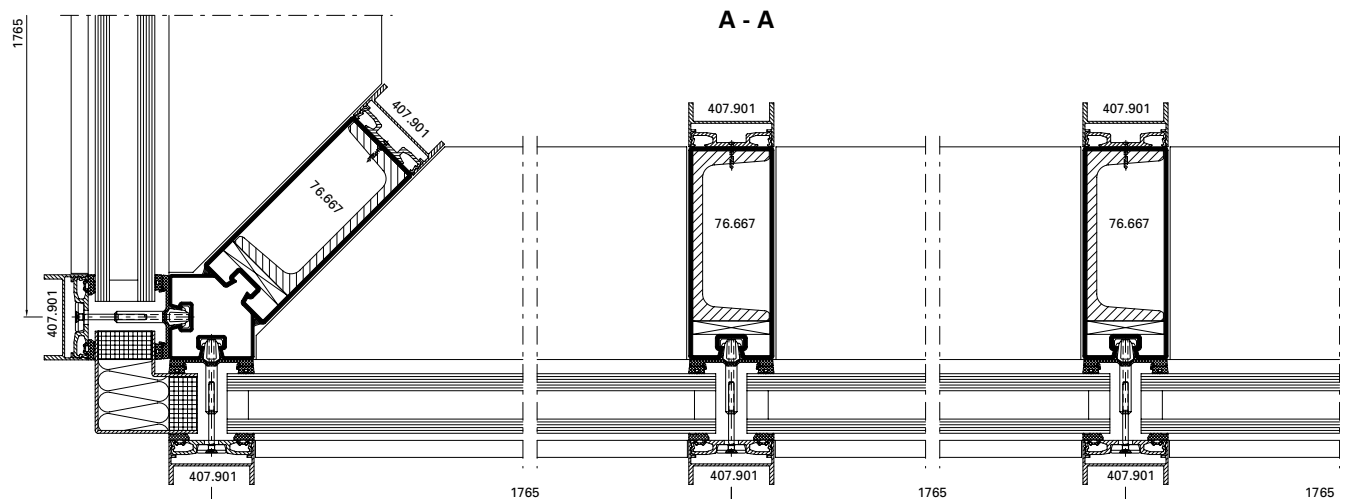

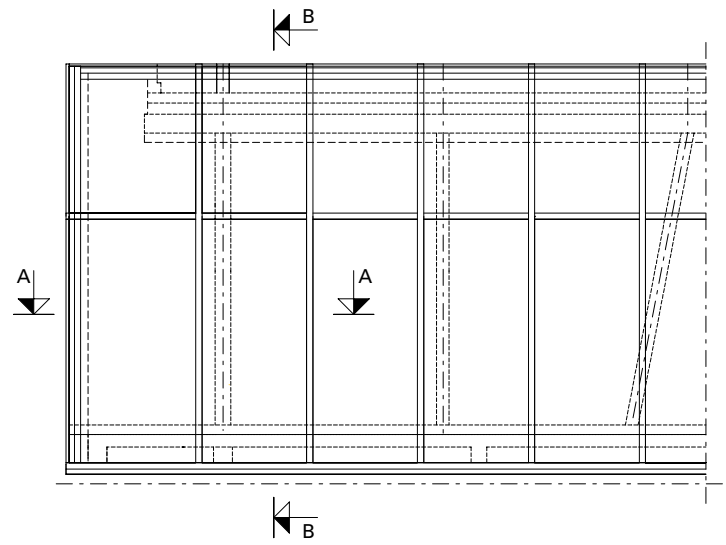
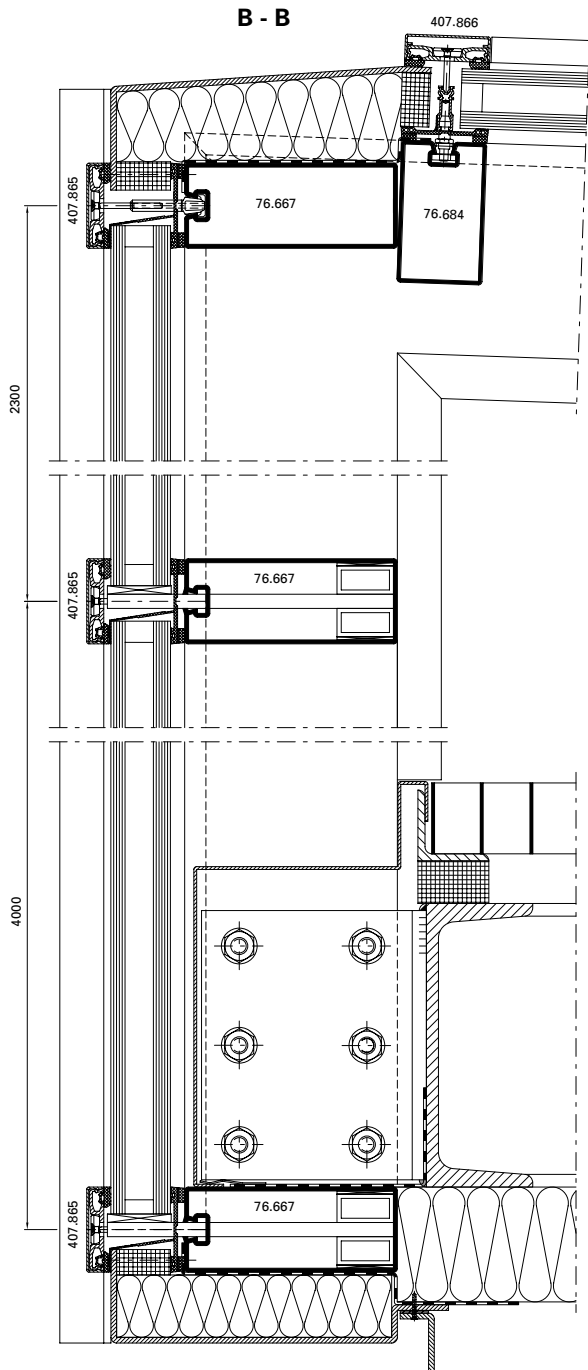

Ausgeführte Objekte

Objets réalisés

Completed projects

Objekt:

Hotel Novi Spa,
Novi Vinodolski/HR

System:

VISS TV Linea

Architekt:

Architekturstudio Banas und Cimas,
Rijeka/HR

Objet:

Hôtel Novi Spa,
Novi Vinodolski/HR

Système:

VISS TV Linea

Architecte:

Architekturstudio Banas und Cimas,
Rijeka/HR

Project:

Novi Spa Hotel,
Novi Vinodolski/HR

System:

VISS TV Linea

Architect:

Architekturstudio Banas und Cimas,
Rijeka/HR



Objekt:

Solvias AG, Büro- und Lagergebäude, Kaiseraugst/CH

System:

VISS TV Linea

Architekt:

Zwimpfer Partner Architekten, Basel/CH

Objet:

Solvias AG, immeuble de bureaux et d'entrepôt, Kaiseraugst/CH

Système:

VISS TV Linea

Architecte:

Zwimpfer Partner Architekten, Bâle/CH

Project:

Solvias AG, office and warehouse facility, Kaiseraugst/CH

System:

VISS TV Linea

Architect:

Zwimpfer Partner Architekten, Basle/CH



Ausgeführte Objekte

Objets réalisés

Completed projects

Objekt:

Médiathèque, Pau/FR

System:

VISS Fire EW60, VISS Basic,
Janisol 3 E160

Architekt:

CANAL, Paris/FR

Objet:

Médiathèque, Pau/FR

Système:

VISS Fire EW60, VISS Basic,
Janisol 3 E160

Architecte:

CANAL, Paris/FR

Project:

Médiathèque, Pau/FR

System:

VISS Fire EW60, VISS Basic,
Janisol 3 E160

Architect:

CANAL, Paris/FR



A - A

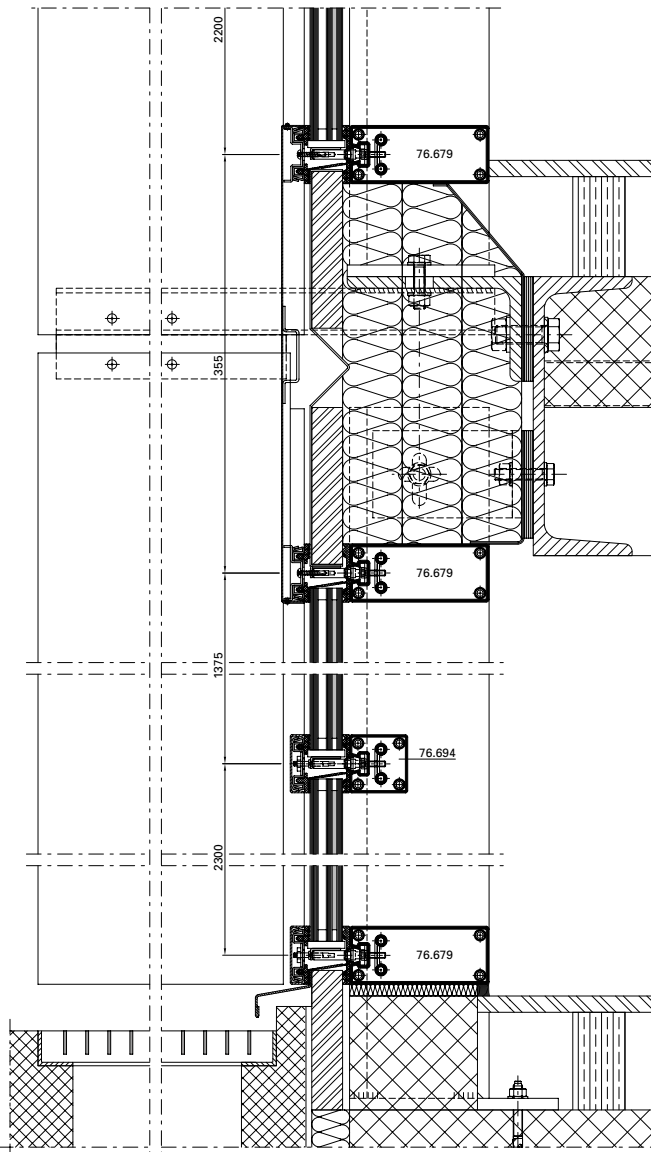

B - B

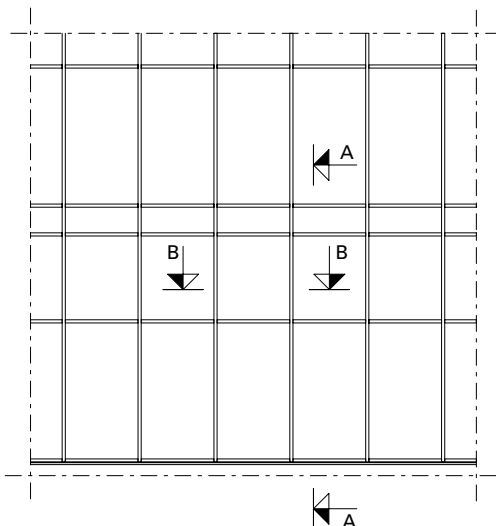
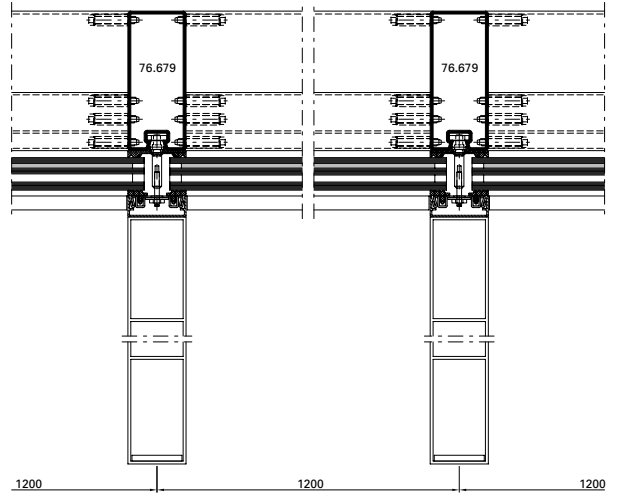

Ausgeführte Objekte

Objets réalisés

Completed projects

Objekt:

«Mumuth» Haus für Musik & Musiktheater der Kunstuniversität, Graz/AT

System:

VISS TVS

Architekt:

UNStudio, Arch. Ben van Berkel en Bos, Amsterdam/NL

Objet:

«Mumuth» Maison de la musique & du théâtre musical de l'université des arts, Grace/AT

Système:

VISS TVS

Architecte:

UNStudio, Arch. Ben van Berkel en Bos, Amsterdam/NL

Project:

«Mumuth» House of Music & Music Drama at the University of Music and Performing Arts, Graz/AT

System:

VISS TVS

Architect:

UNStudio, Arch. Ben van Berkel en Bos, Amsterdam/NL



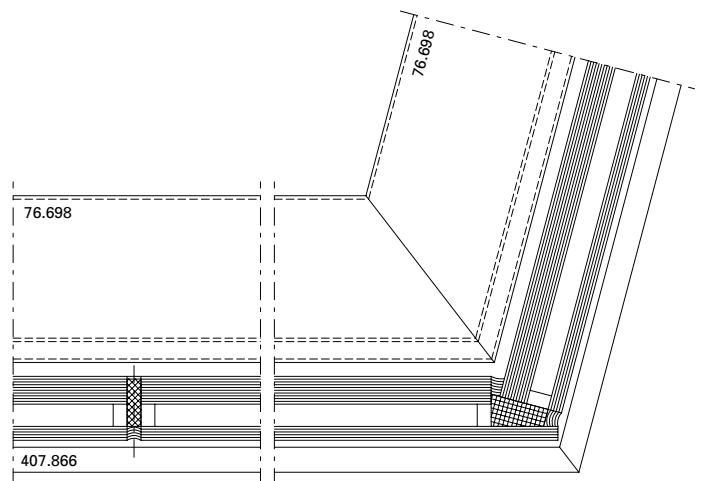
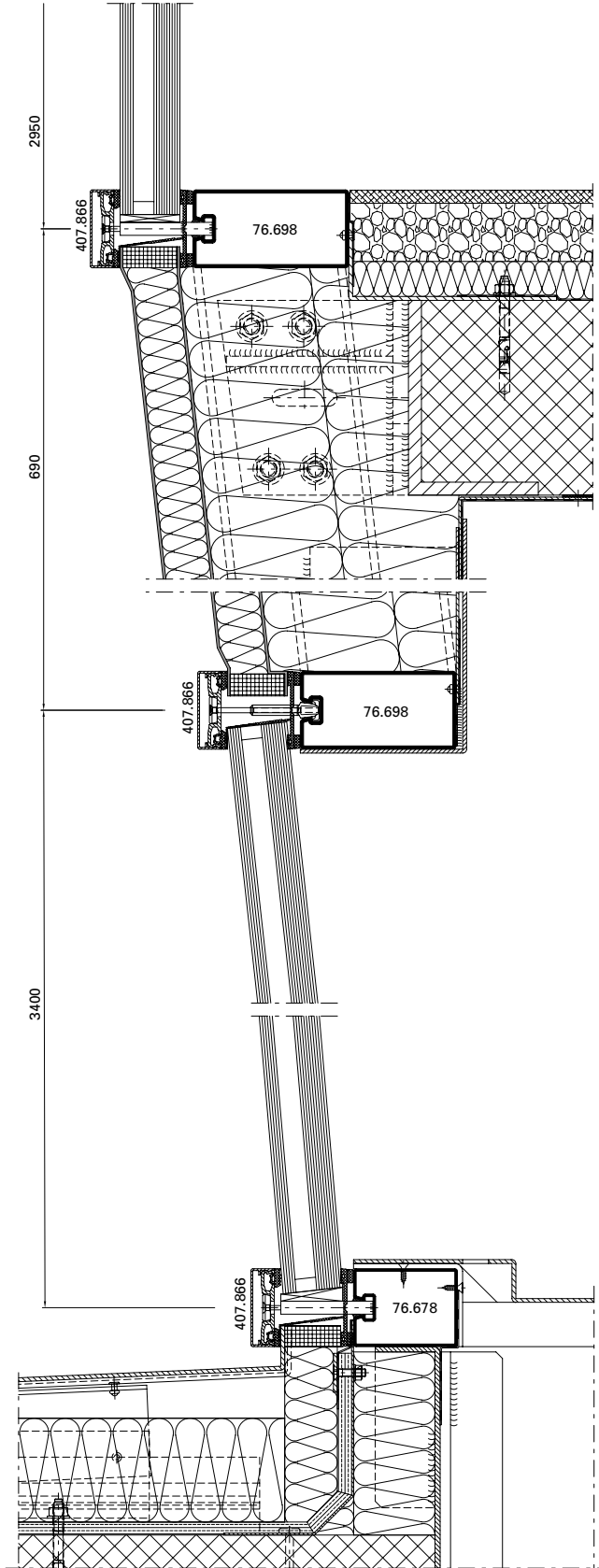

Ausgeführte Objekte
Objets réalisés
Completed projects



Project:

Centre Pompidou, Metz/FR

System:

VISS Fire EI60,
Jansen-Economy 50 E30

Architect:

Shigeru Ban Architects, Paris/FR

Objet:

Centre Pompidou, Metz/FR

Système:

VISS Fire EI60,
Jansen-Economy 50 E30

Architecte:

Shigeru Ban Architects, Paris/FR

Objekt:

Centre Pompidou, Metz/FR

System:

VISS Fire EI60,
Jansen-Economy 50 E30

Architekt:

Shigeru Ban Architects, Paris/FR



Objekt:

Alters- und Pflegeheim,
Burgdorf/CH

System:

VISS Basic TV

Architekt:

Gauer Itten Messerli Architekten AG,
Bern/CH

Objet:

Home pour personnes âgées, Burgdorf/
CH

Système:

VISS Basic TV

Architecte:

Gauer Itten Messerli Architekten AG,
Bern/CH

Project:

Old-age and nursing home, Burgdorf/
CH

System:

VISS Basic TV

Architect:

Gauer Itten Messerli Architekten AG,
Bern/CH

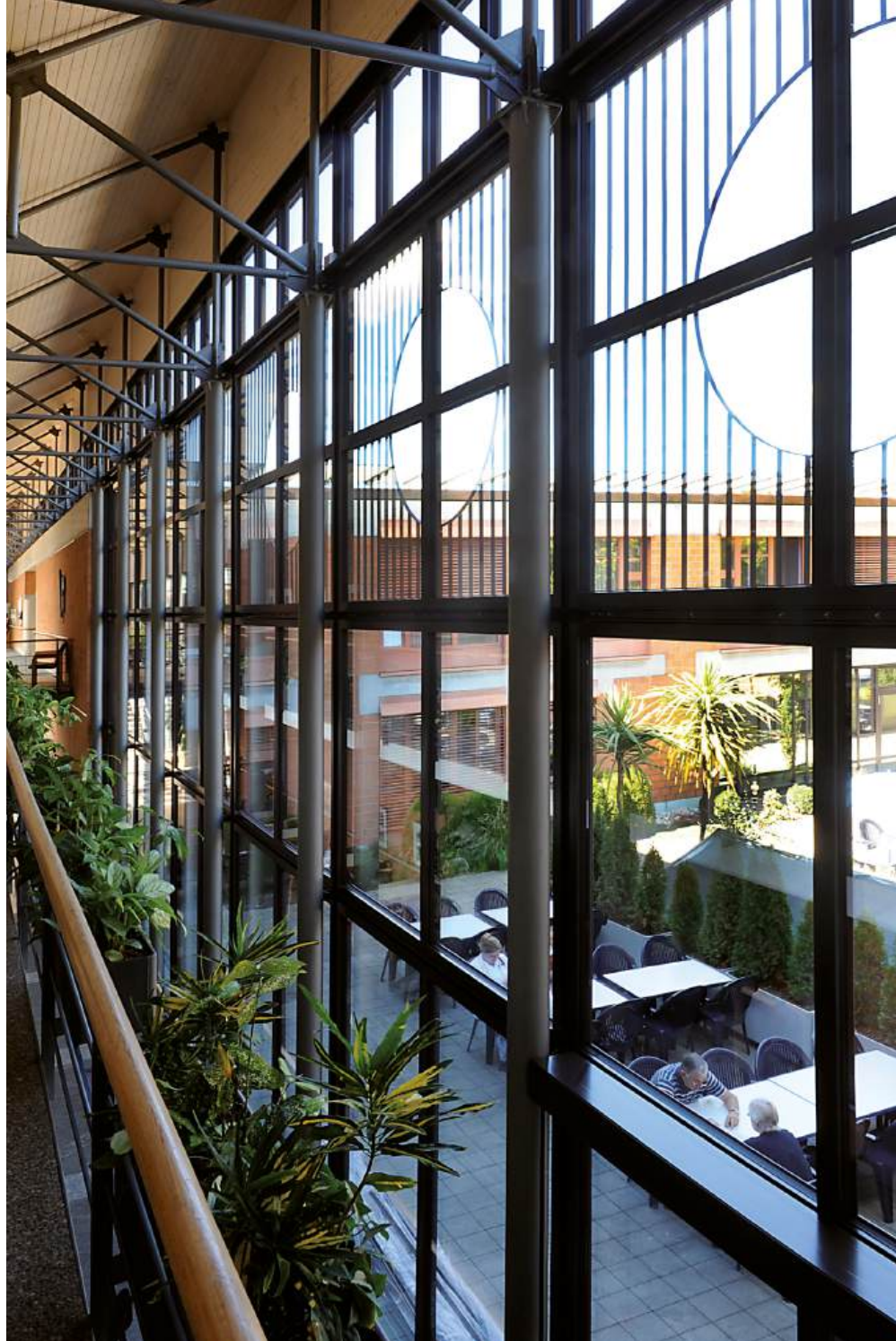

Ausgeführte Objekte Objets réalisés Completed projects

Objekt:

Drents Museum, Assen/NL

System:

VISS Basic TV,
Jansen-Economy 50 EW60

Architekt:

Designed by Erick van Egeraat,
Rotterdam/NL

Objet:

Musée Drents, Assen/NL

Système:

VISS Basic TV,
Jansen-Economy 50 EW60

Architecte:

Designed by Erick van Egeraat,
Rotterdam/NL

Project:

Drents Museum, Assen/NL

System:

VISS Basic TV,
Jansen-Economy 50 EW60

Architect:

Designed by Erick van Egeraat,
Rotterdam/NL



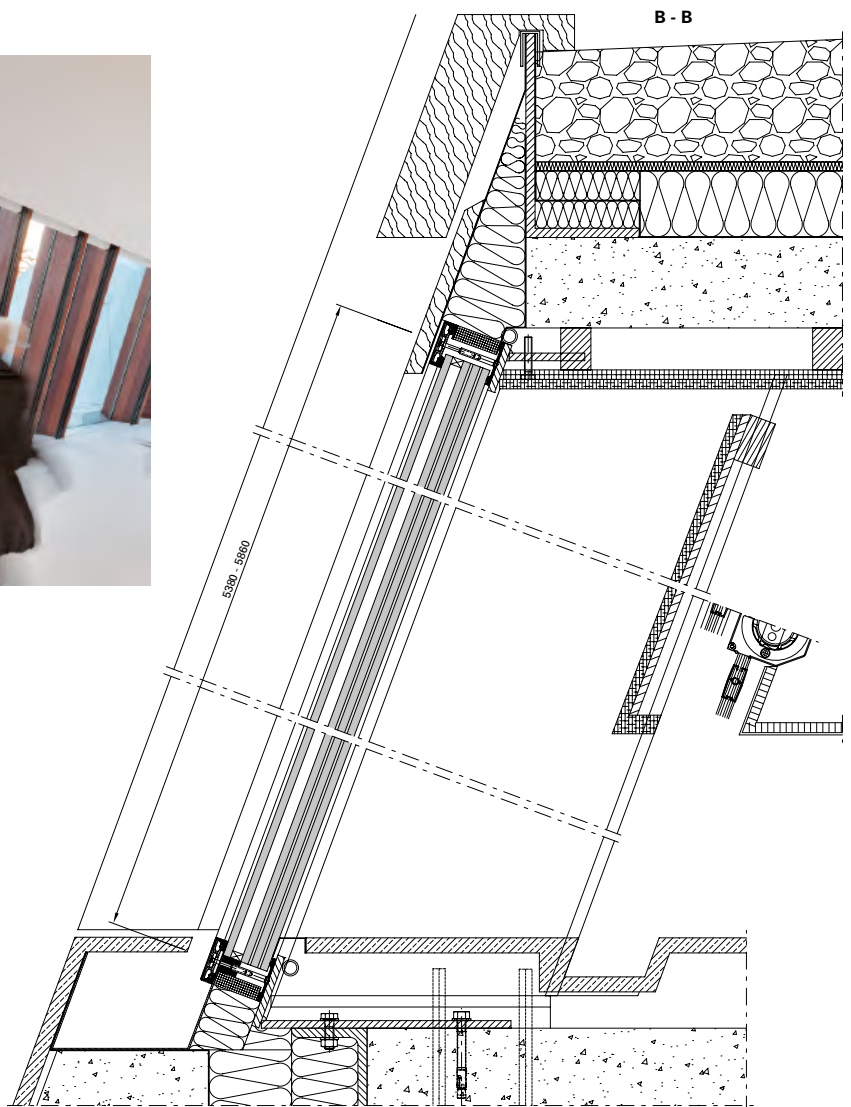
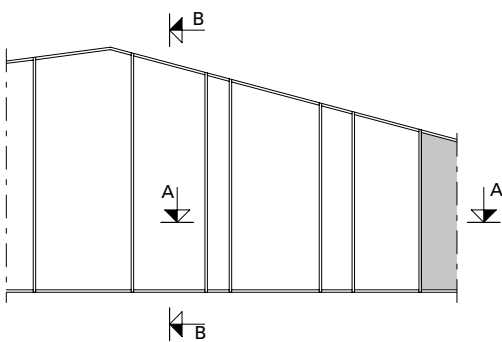
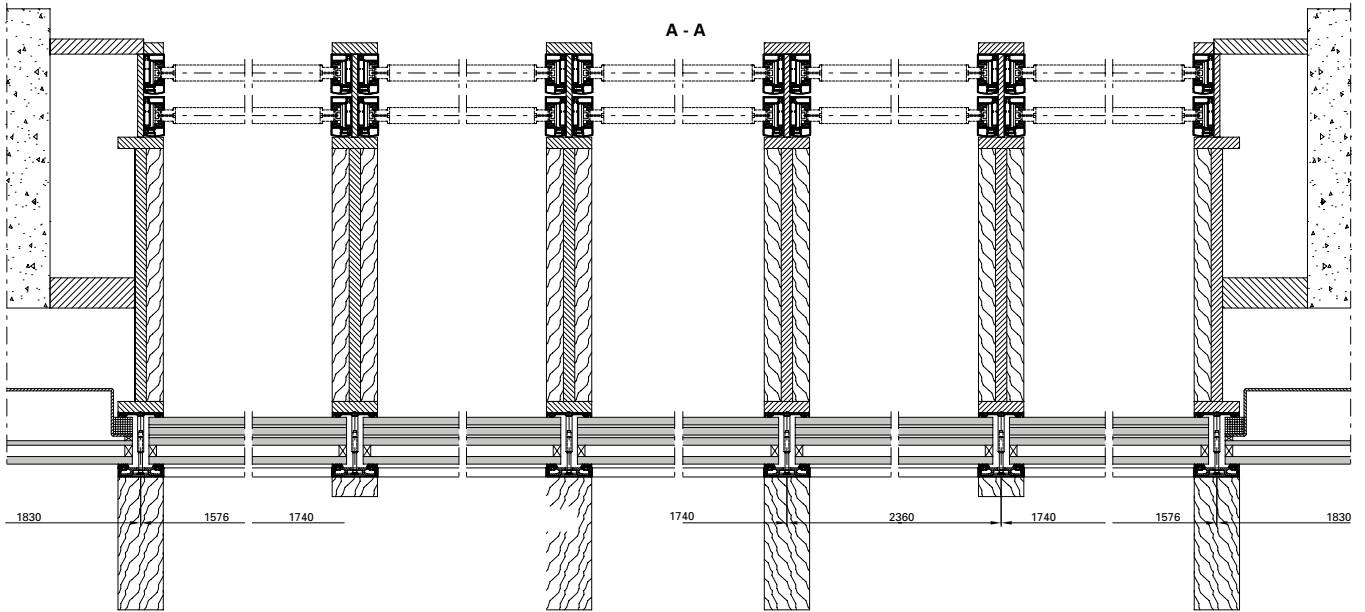

Ausgeführte Objekte Objets réalisés Completed projects

Objekt:

Akkustik-Tunnels,
Warschau/PL

System:

VISS Basic TVS (schräg)

Architekt:

Transprojekt, Warschau/PL
FOROOM Bartłomiej Grotte,
Warschau/PL

Objet:

Tunnels acoustiques,
Varsovie/PL

Système:

VISS Basic TVS (oblique)

Architecte:

Transprojekt, Varsovie/PL
FOROOM Bartłomiej Grotte,
Varsovie/PL

Project:

Acoustic tunnels,
Warsaw/PL

System:

VISS Basic TVS (sloping)

Architect:

Transprojekt, Warsaw/PL
FOROOM Bartłomiej Grotte,
Warsaw/PL

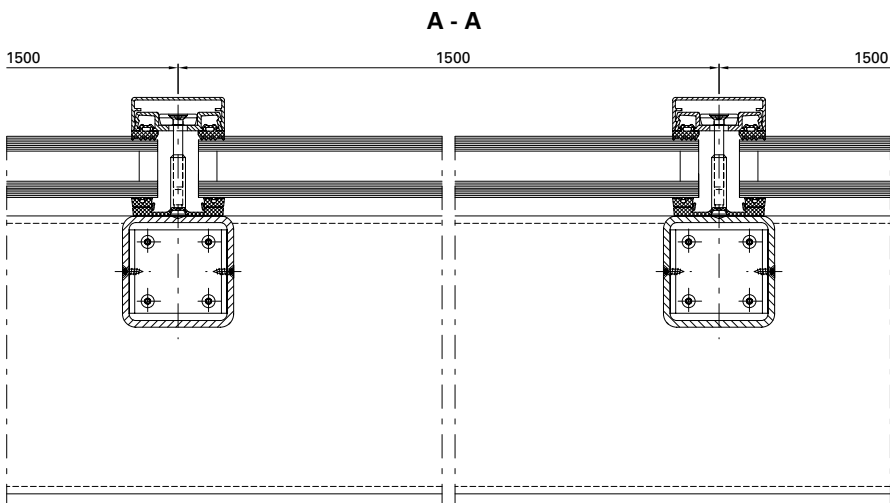

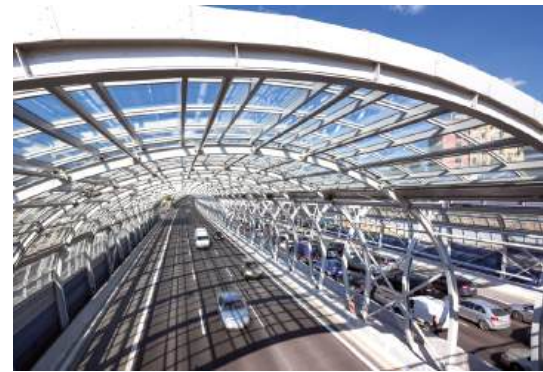
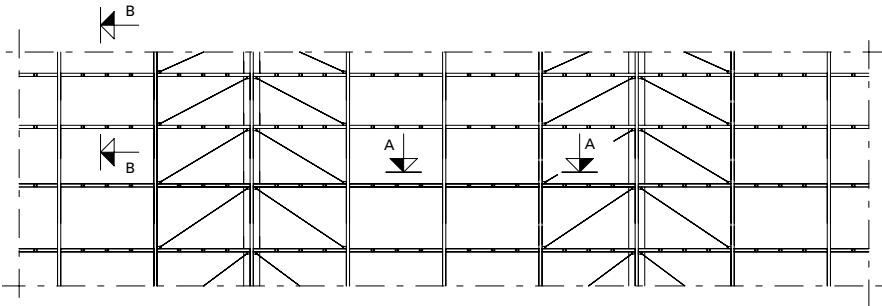
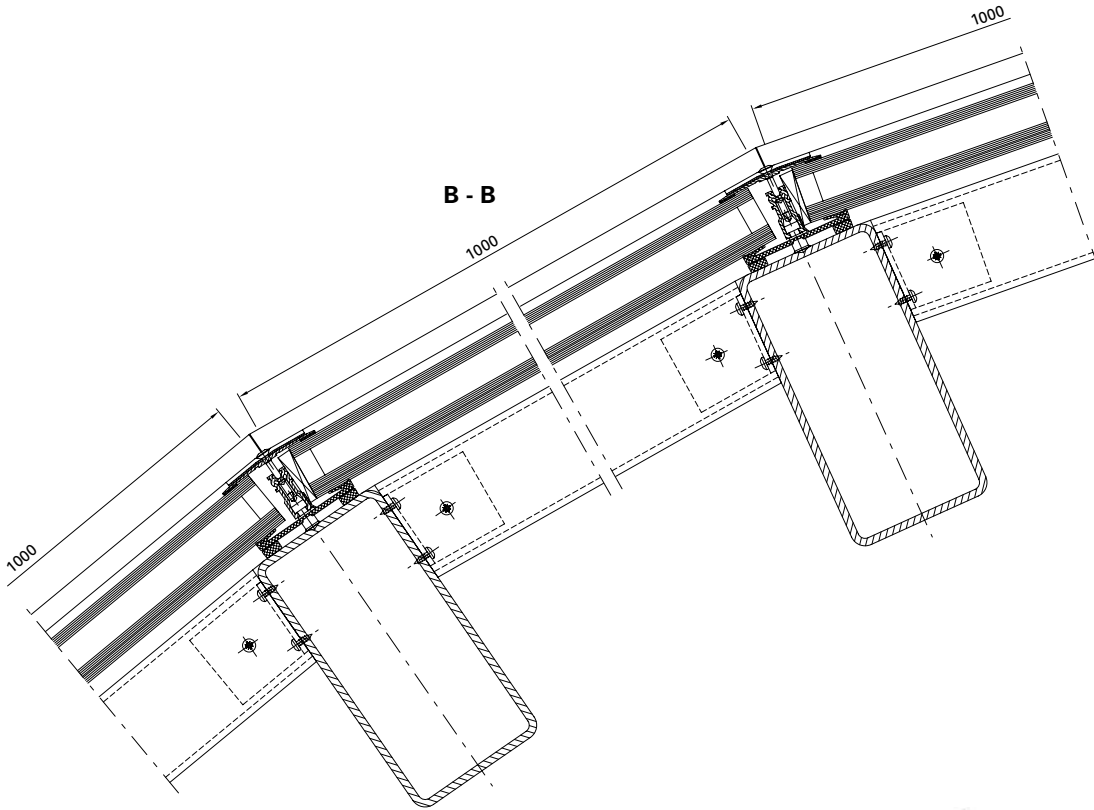

Ausgeführte Objekte
Objets réalisés
Completed projects

Objekt:

Jin Ji Hu Kempinski Hotel, Suzhou/CN

System:

VISS TV

Architekt:

Suzhou Architecture and Design
Institute, Shanghai/CN

Objet:

Hôtel Jin Ji Hu Kempinski, Suzhou/CN

Système:

VISS TV

Architecte:

Suzhou Architecture and Design
Institute, Shanghai/CN

Project:

Jin Ji Hu Kempinski Hotel, Suzhou/CN

System:

VISS TV

Architect:

Suzhou Architecture and Design
Institute, Shanghai/CN



Objekt:

Historisches Museum,
Kharkov/UA

System:

VISS I_xtra, Janisol Türen

Architekt:

S. Chechelnytskiy, M. Polivanova,
T. Polivanova, Kharkov/UA

Objet:

Musée historique,
Kharkov/UA

Système:

VISS I_xtra, portes Janisol

Architecte:

S. Chechelnytskiy, M. Polivanova,
T. Polivanova, Kharkov/UA

Project:

Historical museum,
Kharkov/UA

System:

VISS I_xtra, Janisol doors

Architect:

S. Chechelnytskiy, M. Polivanova,
T. Polivanova, Kharkov/UA

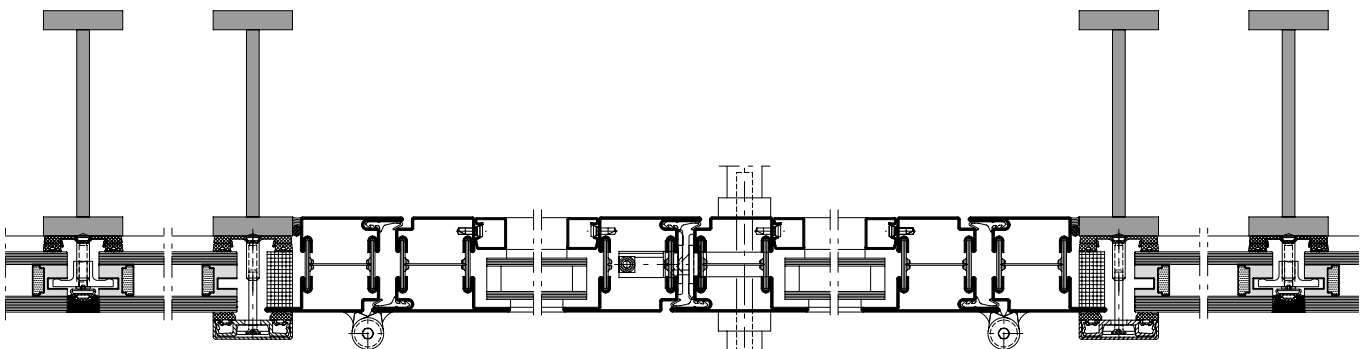

Ausgeführte Objekte Objets réalisés Completed projects

Objekt:

Kunstgebäude, Stuttgart/DE

System:

VISS TVS (schräg)

Architekt:

Harder III Stumpf, Freie Architekten,
Stuttgart/DE

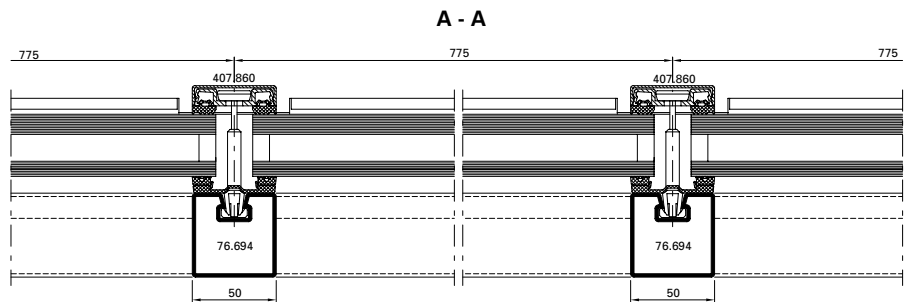
**Objet:**

Bâtiment des arts, Stuttgart/DE

Système:

VISS TVS (oblique)

Architecte:

Harder III Stumpf, Freie Architekten,
Stuttgart/DE

Project:

Art building, Stuttgart/DE

System:

VISS TVS (sloping)

Architect:

Harder III Stumpf, Freie Architekten,
Stuttgart/DE



Ausgeführte Objekte

Objets réalisés

Completed projects

Objekt:

3-Feldsporthalle, Ingelfingen/DE

System:

VISS TVS HI, VISS Fire E30/E90,
Janisol Primo, Janisol Türen,
Janisol 2 E130, Jansen-Economy 60

Architekt:

Hein, Hüttel und Lindenberger,
Ludwigsburg/DE

Objet:

Salle de sport triple, Ingelfingen/DE

Système:

VISS TVS HI, VISS Fire E30/E90,
Janisol Primo, portes Janisol,
Janisol 2 E130, Jansen-Economy 60

Architecte:

Hein, Hüttel und Lindenberger,
Ludwigsburg/DE

Project:

3-field sports hall, Ingelfingen/DE

System:

VISS TVS HI, VISS Fire E30/E90,
Janisol Primo, Janisol doors,
Janisol 2 E130, Jansen-Economy 60

Architect:

Hein, Hüttel und Lindenberger,
Ludwigsburg/DE

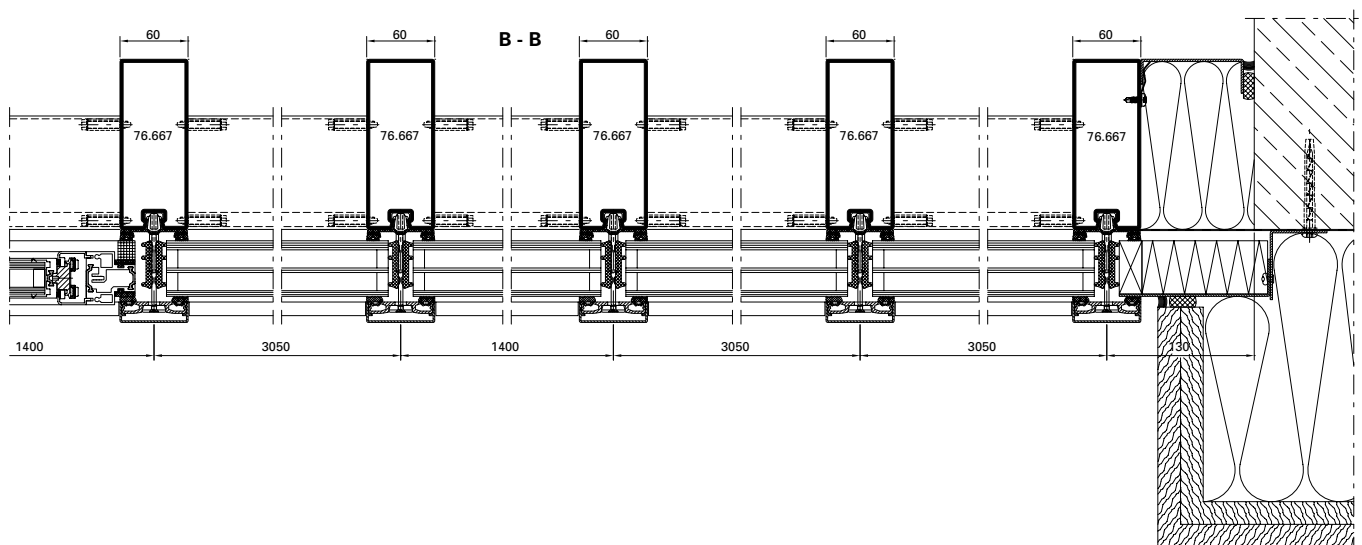

A - A

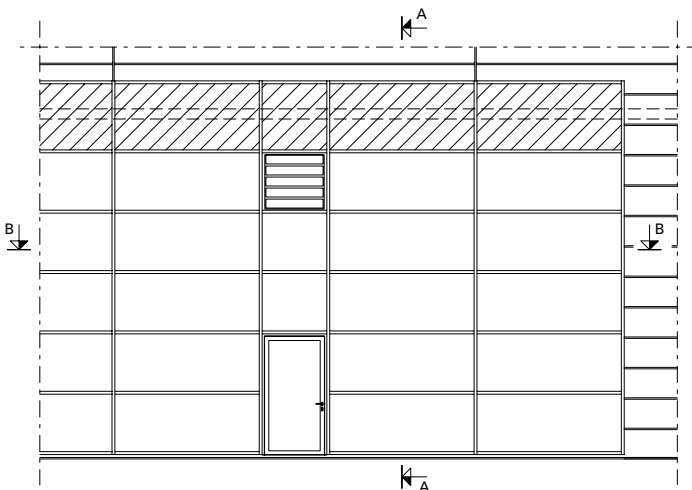
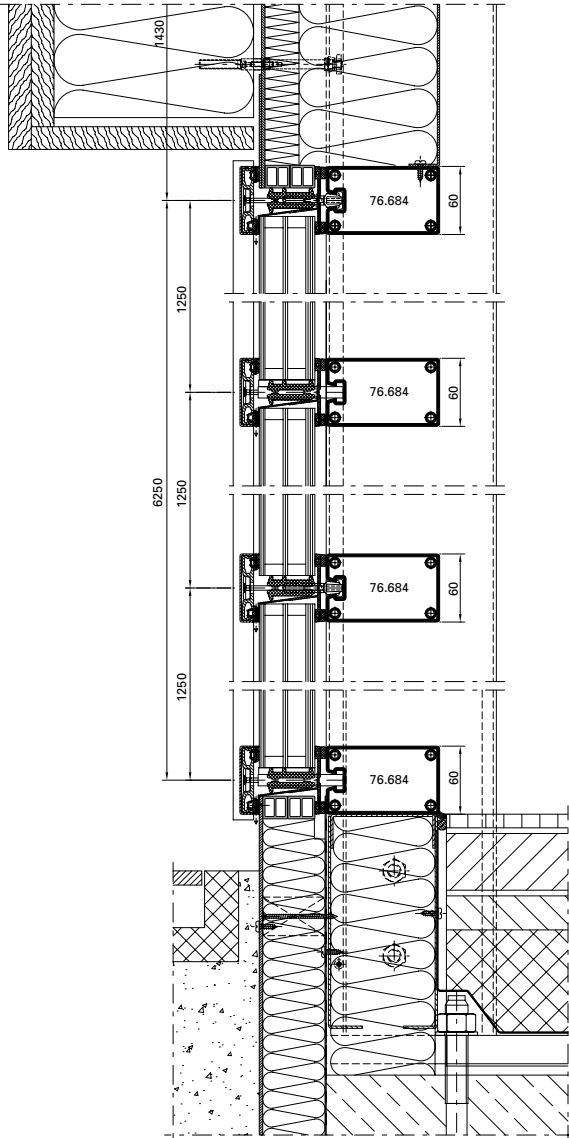

Ausgeführte Objekte

Objets réalisés

Completed projects

Objekt:

Musikkonservatorium, Bilbao/ES

System:

VISS TVS

Architekt:

Roberto Ercilla Arquitectura,
Vitoria/ES

Objet:

Conservatoire de musique, Bilbao/ES

Système:

VISS TVS

Architecte:

Roberto Ercilla Arquitectura,
Vitoria/ES

Project:

Conservatory of Music, Bilbao/ES

System:

VISS TVS

Architect:

Roberto Ercilla Arquitectura,
Vitoria/ES



Objekt:

Landesberufsschule, Mureck/AT

System:

VISS TVS Linea

Architekt:

Architekten Domenig & Wallner
ZT GmbH, Graz/AT

Objet:

École professionnelle, Mureck/AT

Système:

VISS TVS Linea

Architecte:

Architekten Domenig & Wallner
ZT GmbH, Graz/AT

Project:

State vocational school, Mureck/AT

System:

VISS TVS Linea

Architect:

Architekten Domenig & Wallner
ZT GmbH, Graz/AT



Ausgeführte Objekte
Objets réalisés
Completed projects



Fotos: Jochen Helle, Dortmund

Objekt:

Hafencity Schule, Hamburg/DE

System:

VISS Fire E30 TVS vertikal und schräg,
Janisol Türen

Architekt:

Spengler-Wiescholek Architekten,
Hamburg/DE

Objet:

École Hafencity, Hamburg/DE

Système:

VISS Fire E30 TVS vertical et oblique,
Portes Janisol

Architecte:

Spengler-Wiescholek Architekten,
Hamburg/DE

Project:

Hafencity school, Hamburg/DE

System:

VISS Fire E30 TVS vertical and sloping,
Janisol doors

Architect:

Spengler-Wiescholek Architekten,
Hamburg/DE



A - A

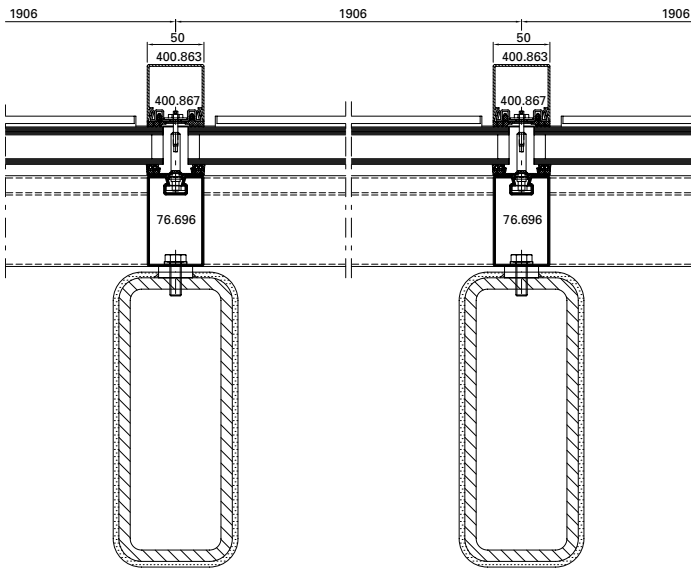

B

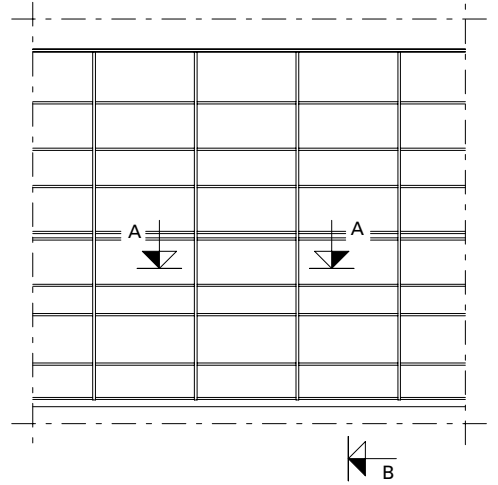

B - B

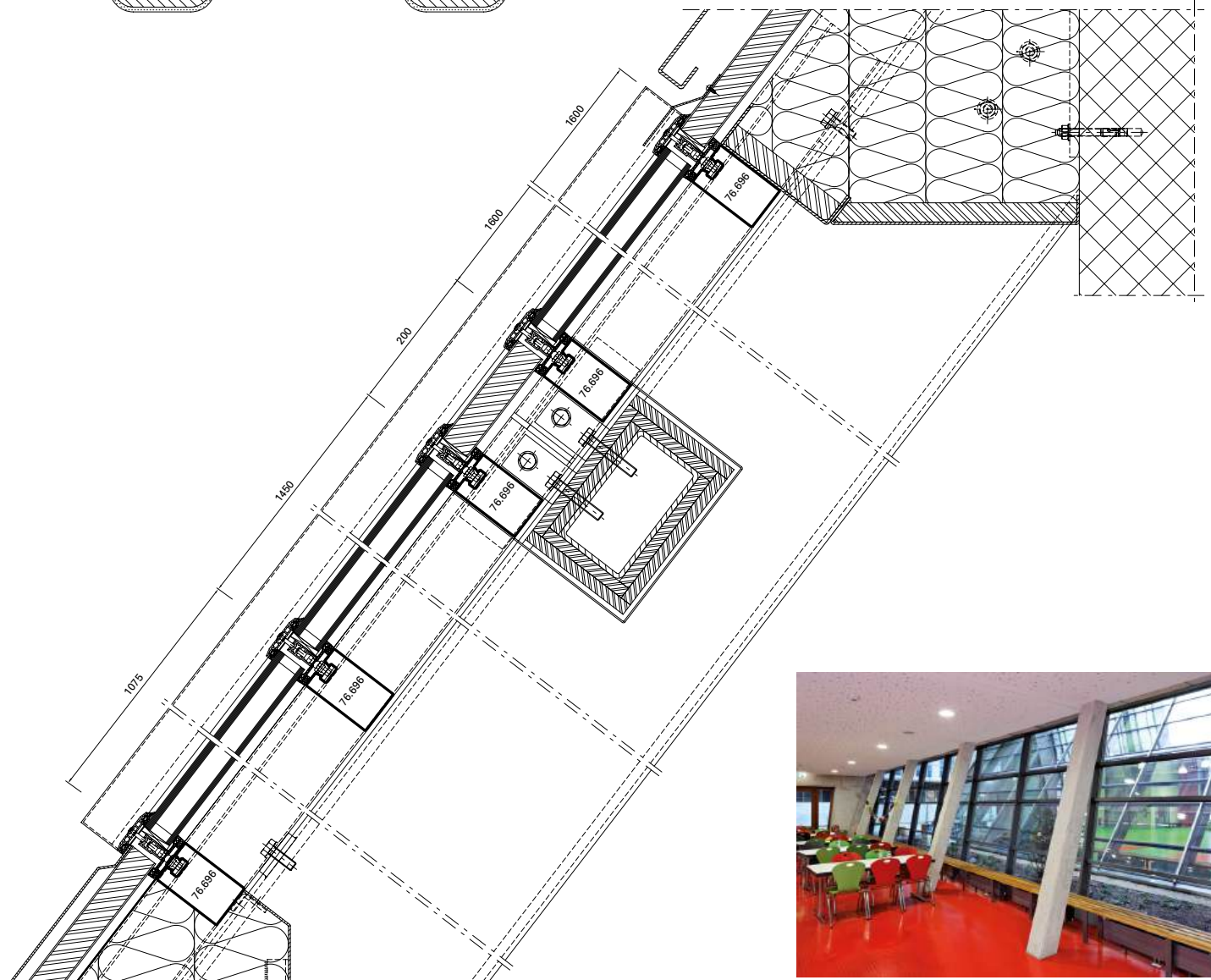

Ausgeführte Objekte

Objets réalisés

Completed projects

Objekt:

Drehrestaurant «Hoher Kasten»,
Brülisau/CH

System:

VISS Basic TVS

Architekt:

architekten : rlc ag, Rheineck/CH

Objet:

Restaurant panoramique
«Hoher Kasten», Brülisau/CH

Système:

VISS Basic TVS

Architecte:

architekten : rlc ag, Rheineck/CH

Project:

Revolving restaurant «Hoher Kasten»,
Brülisau/CH

System:

VISS Basic TVS

Architect:

architekten : rlc ag, Rheineck/CH

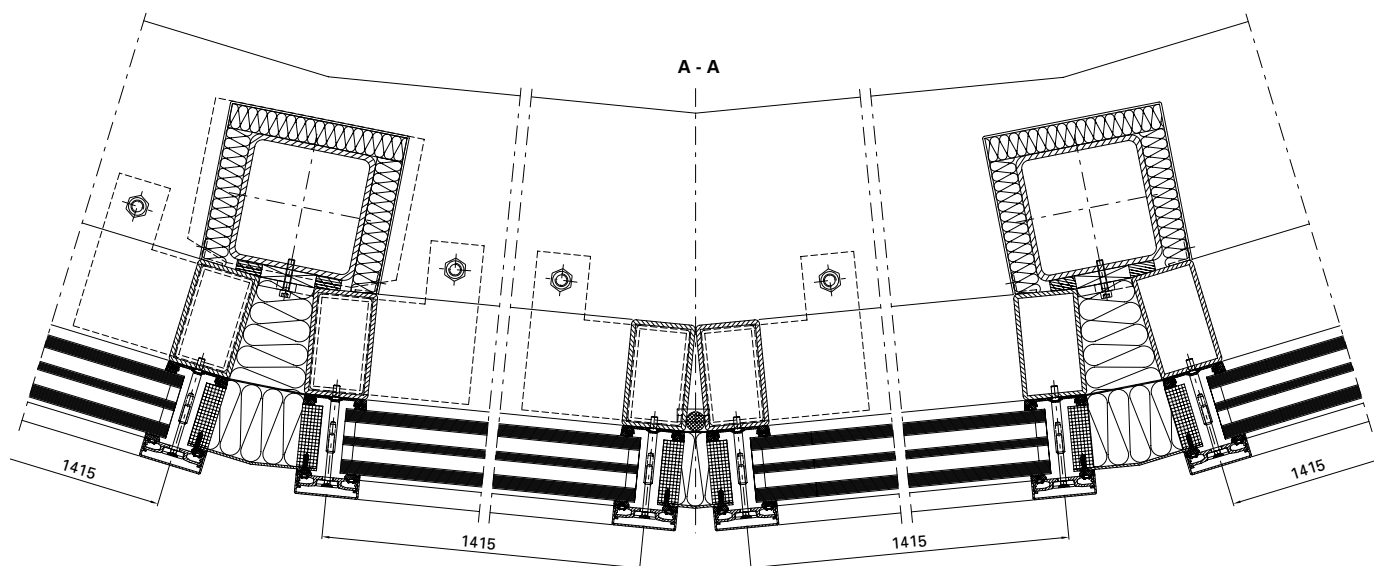

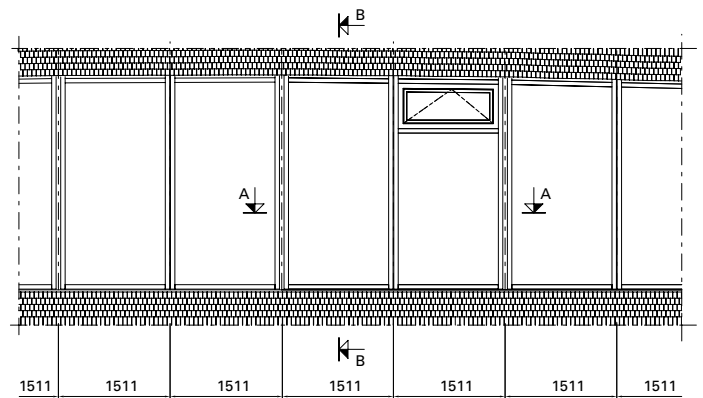
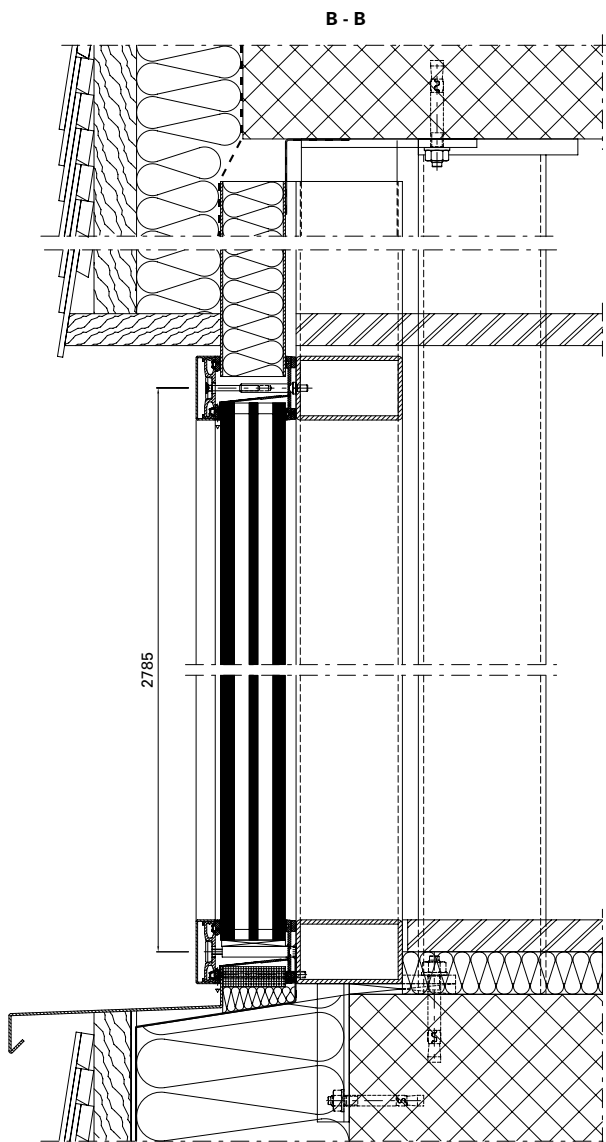

Ausgeführte Objekte

Objets réalisés

Completed projects

Objekt:

Hauptbahnhof «Rotterdam Centraal»,
Rotterdam/NL

System:

VISS Basic, VISS Fire, Janisol Türen

Architekt:

Team CS: Zusammenarbeit von
Bentham Crowel Architekten,
Meyer en Van Schooten Architecten
und West 8, Rotterdam/NL

Objet:

Gare centrale «Rotterdam Centraal»,
Rotterdam/NL

Système:

VISS Basic, VISS Fire, portes Janisol

Architecte:

Team CS: Coopération de Bentham
Crowel Architectes, Meyer en Van
Schooten Architectes et West 8,
Rotterdam/NL

Project:

Central station «Rotterdam Centraal»,
Rotterdam/NL

System:

VISS Basic, VISS Fire, Janisol doors

Architect:

Team CS: a cooperation of Bentham
Crowel Architects, Meyer en Van
Schooten Architects and West 8,
Rotterdam/NL

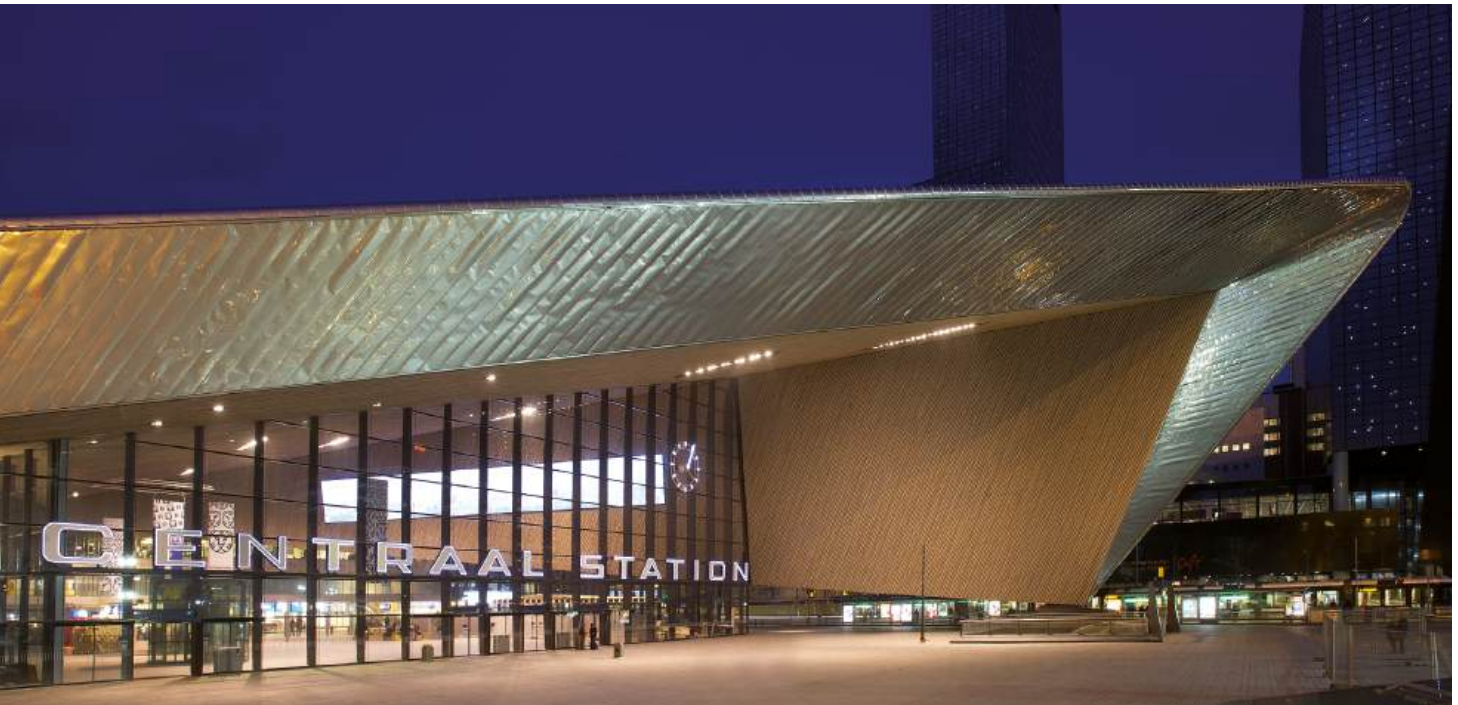



Ausgeführte Objekte

Objets réalisés

Completed projects

Objekt:

IGuzzini Illuminazione, Barcelona/ES

System:

VISS TVS, Janisol Fenster und Türen,
Jansen-Economy 50/60

Architekt:

Josep Mias, Mias Arquitectos ACTAR,
Barcelona/ES

Objet:

IGuzzini Illuminazione, Barcelone/ES

Système:

VISS TVS, Janisol portes et fenêtres,
Jansen-Economy 50/60

Architecte:

Josep Mias, Mias Arquitectos ACTAR,
Barcelone/ES

Project:

IGuzzini Illuminazione, Barcelona/ES

System:

VISS TVS, Janisol doors and windows,
Jansen-Economy 50/60

Architect:

Josep Mias, Mias Arquitectos ACTAR,
Barcelona/ES

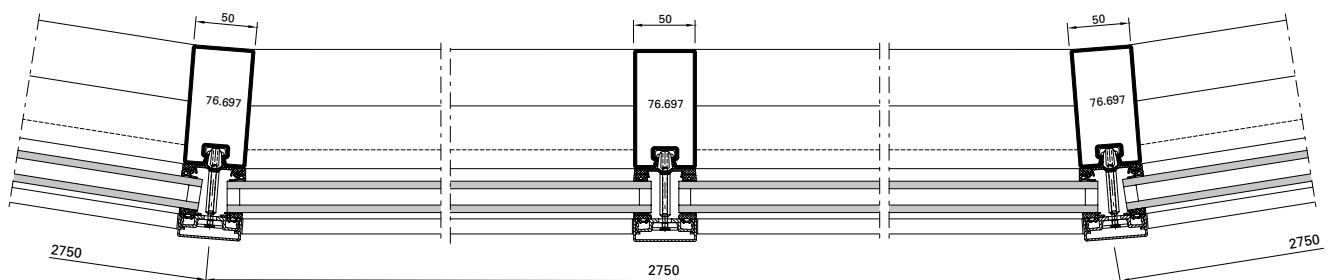

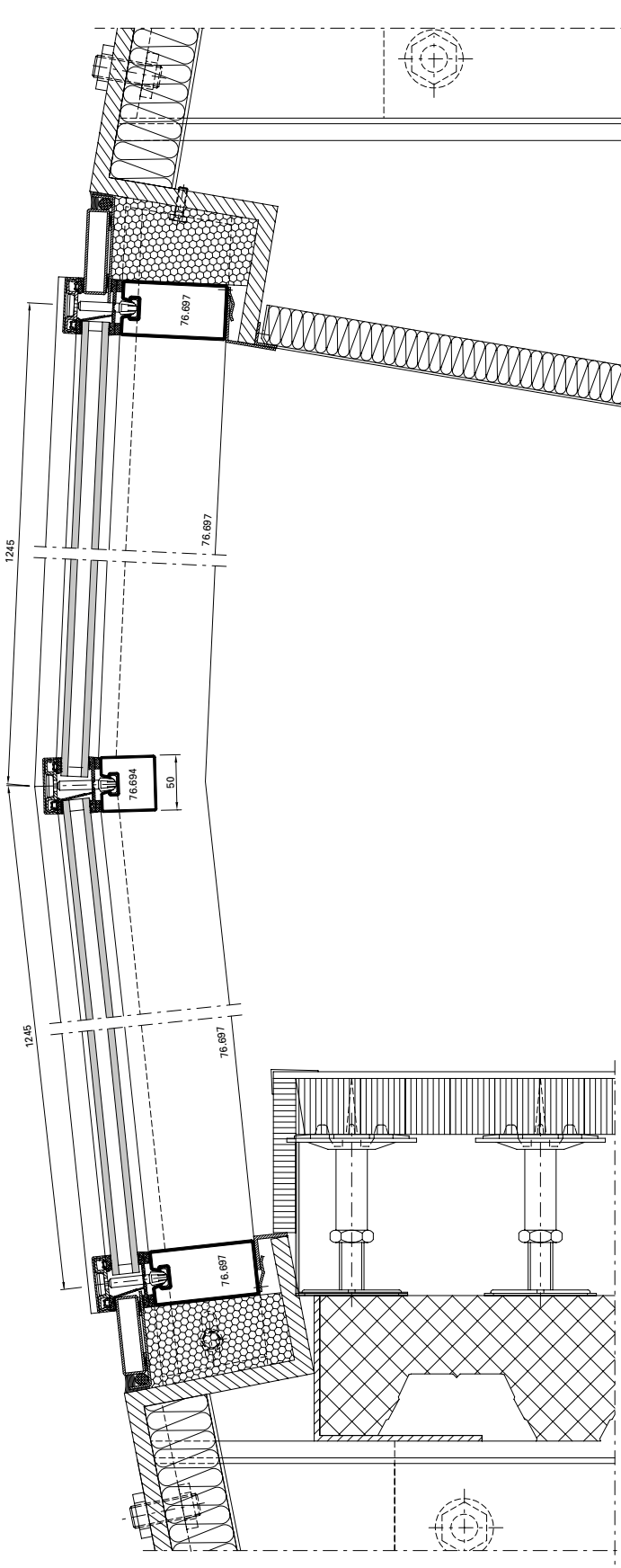

Ausgeführte Objekte

Objets réalisés

Completed projects

Objekt:

«Erasmus» Studenten-Pavillon,
Rotterdam/NL

System:

VISS I_xtra SG

Architekt:

Powerhouse Company &
DeZwarteHond, Rotterdam/NL

Objet:

Pavillon pour étudiants «Erasmus»,
Rotterdam/NL

Système:

VISS I_xtra SG

Architecte:

Powerhouse Company &
DeZwarteHond, Rotterdam/NL

Project:

«Erasmus» student pavilion,
Rotterdam/NL

System:

VISS I_xtra SG

Architect:

Powerhouse Company &
DeZwarteHond, Rotterdam/NL

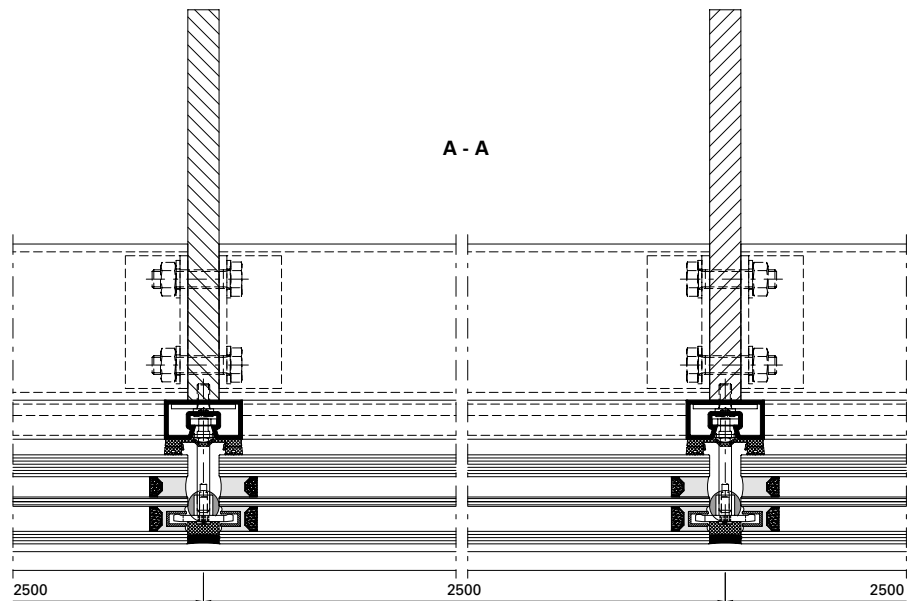

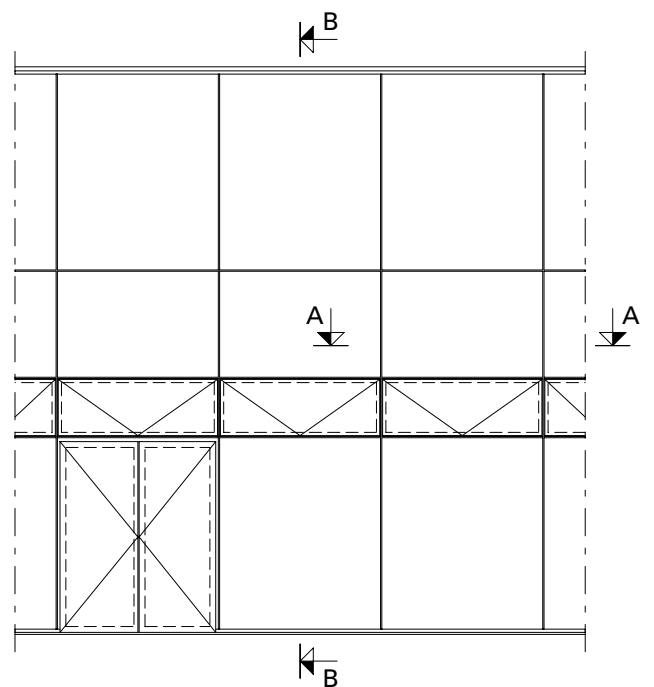
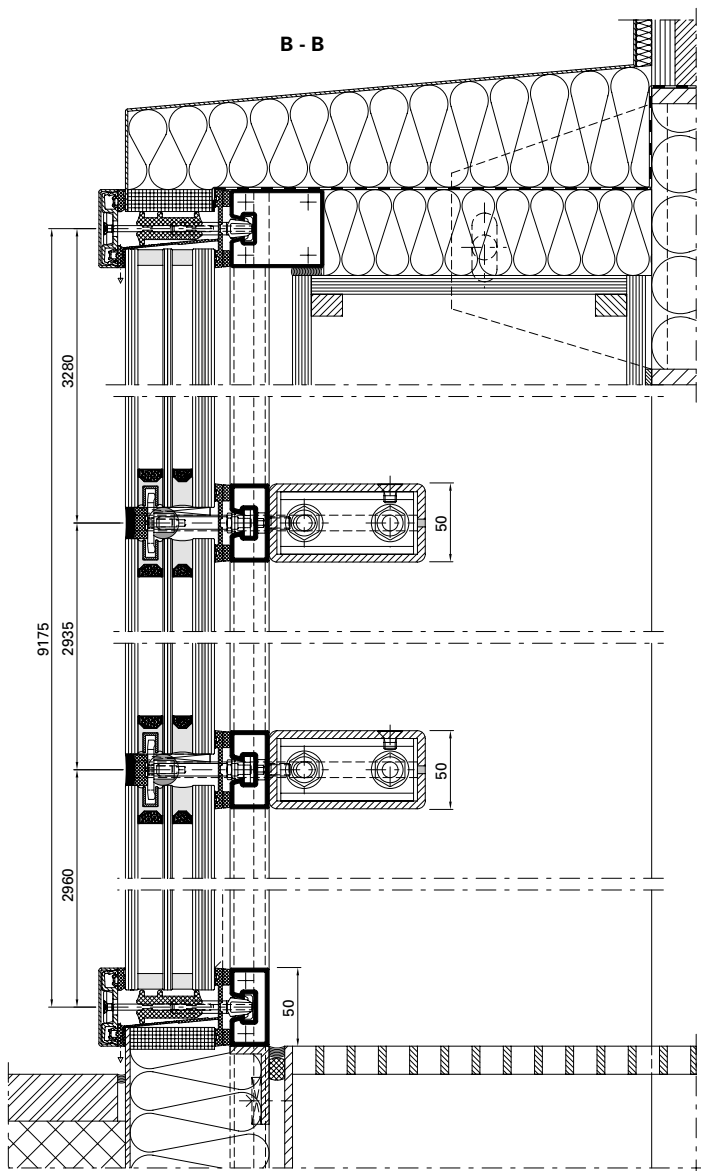

Ausgeführte Objekte
Objets réalisés
Completed projects



Fotos: Stephan Falk, Berlin

Objekt:

Hochschule «Anstalt für angewandte Wissenschaften», Dessau/DE

System:

VISS TVS

Architekt:

Kossel, Simon und Partner,
Magdeburg/DE

Objet:

École supérieure «Anstalt für angewandte Wissenschaften», Dessau/DE

Système:

VISS TVS

Architecte:

Kossel, Simon und Partner,
Magdeburg/DE

Project:

University «Anstalt für angewandte Wissenschaften», Dessau/DE

System:

VISS TVS

Architect:

Kossel, Simon und Partner,
Magdeburg/DE



Objekt:

Justizgebäude, Würzburg/DE

System:

VISS TVS, VISS Fire TVS (schräg)

Architekt:

Staatliches Bauamt Würzburg, Abt. L4, Würzburg/DE

Objet:

Palais de justice, Würzburg/DE

Système:

VISS TVS, VISS Fire TVS (oblique)

Architecte:

Staatliches Bauamt Würzburg, Abt. L4, Würzburg/DE

Project:

Law courts, Würzburg/DE

System:

VISS TVS, VISS Fire TVS (sloping)

Architect:

Staatliches Bauamt Würzburg, Abt. L4, Würzburg/DE



Fotos: Gerhard Hagen, Bamberg

Ausgeführte Objekte Objets réalisés Completed projects

Objekt:

Halle M, Jansen AG, Oberriet/CH

System:

VISS TVS HI

Architekt:

Göldi + Eggenberger AG,
Altstätten/CH

Objet:

Hall M, Jansen AG, Oberriet/CH

Système:

VISS TVS HI

Architecte:

Göldi + Eggenberger AG,
Altstätten/CH

Project:

Hall M, Jansen AG, Oberriet/CH

System:

VISS TVS HI

Architect:

Göldi + Eggenberger AG,
Altstätten/CH



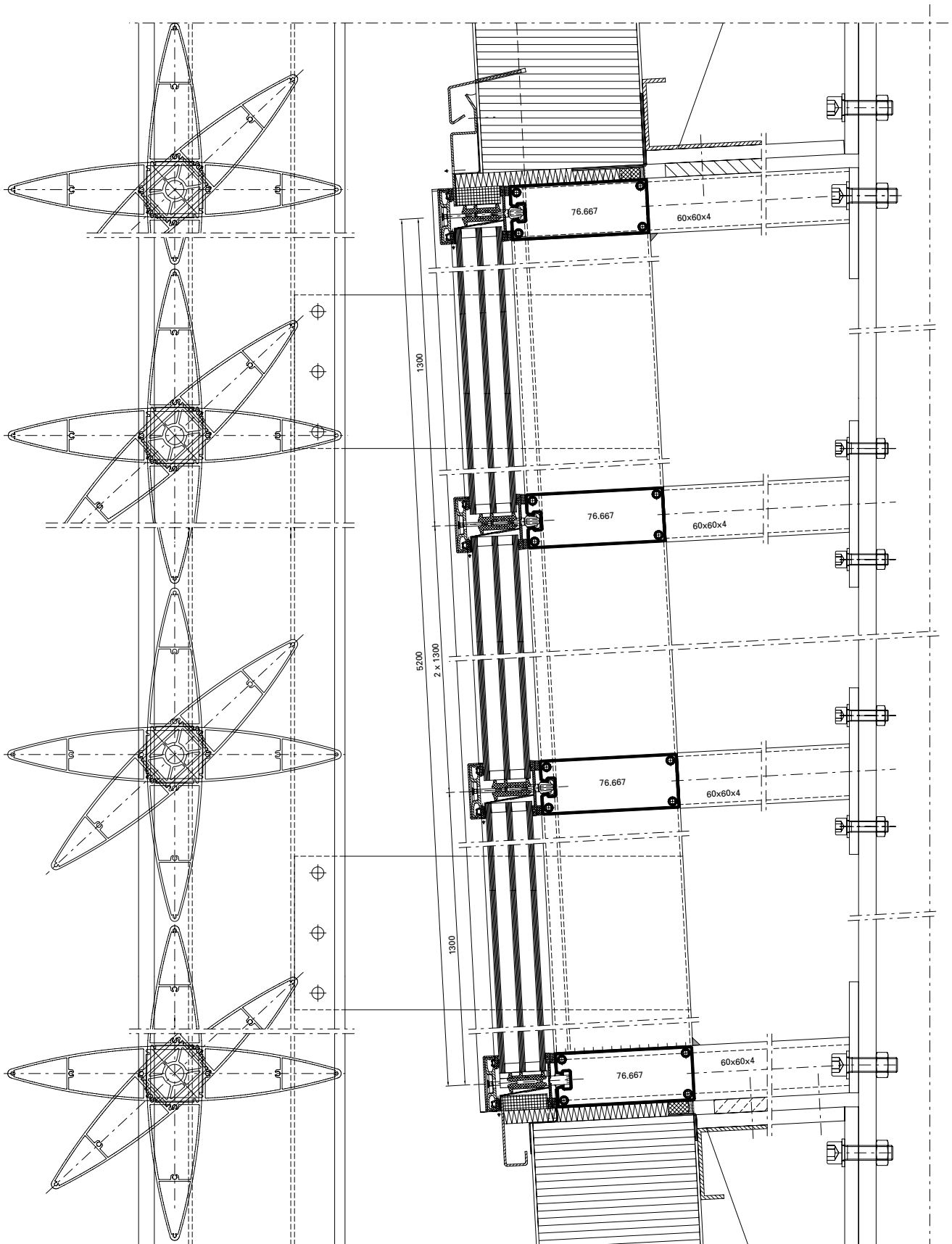

Ausgeführte Objekte
Objets réalisés
Completed projects



Fotos: Stephan Falk, Berlin

Objekt:

Vogtlandhalle (Stadthalle), Greiz/DE

System:

VISS TVS, Janisol Faltwand

Architekt:

Hoffmann.Seifert.Partner mit Ernst Scharf, Erfurt/DE

Objet:

Vogtlandhalle (salle municipale), Greiz/DE

Système:

VISS TVS, Janisol porte repliable

Architecte:

Hoffmann.Seifert.Partner mit Ernst Scharf, Erfurt/DE

Project:

Vogtland hall (city hall), Greiz/DE

System:

VISS TVS, Janisol folding wall

Architect:

Hoffmann.Seifert.Partner mit Ernst Scharf, Erfurt/DE

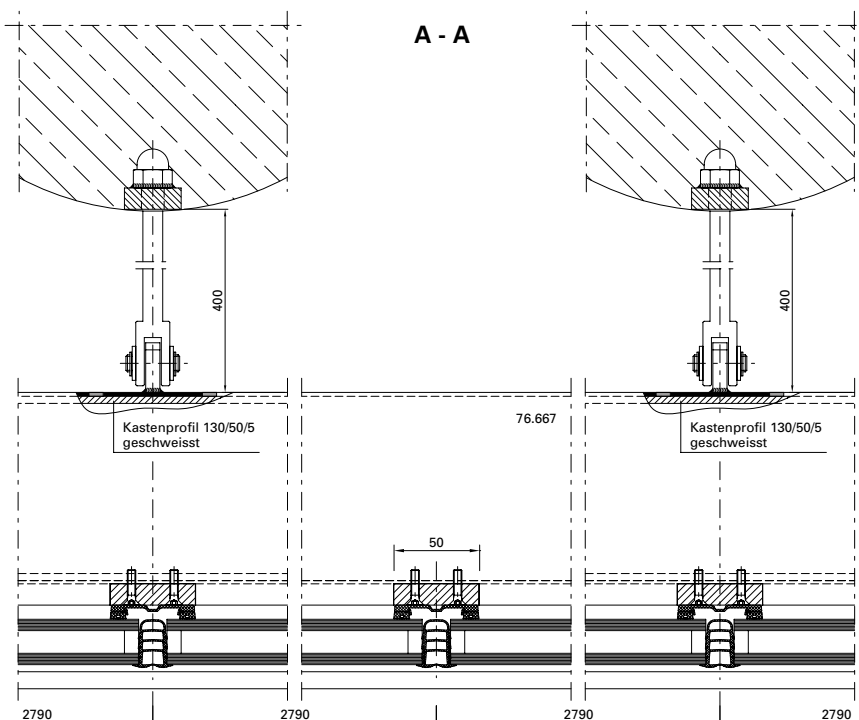

B - B

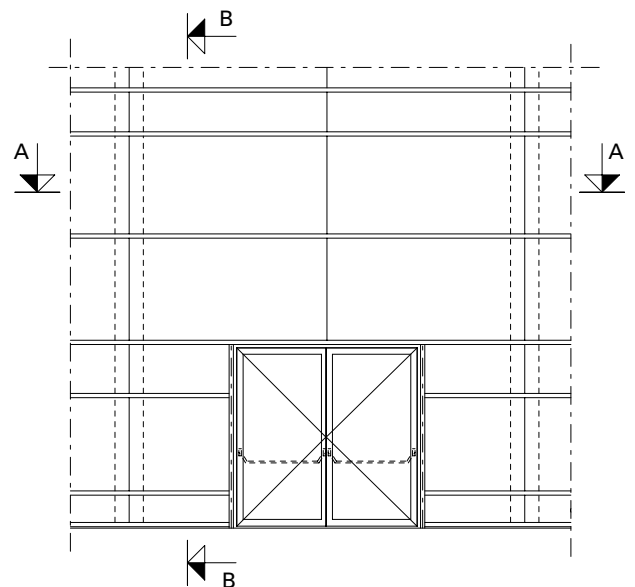
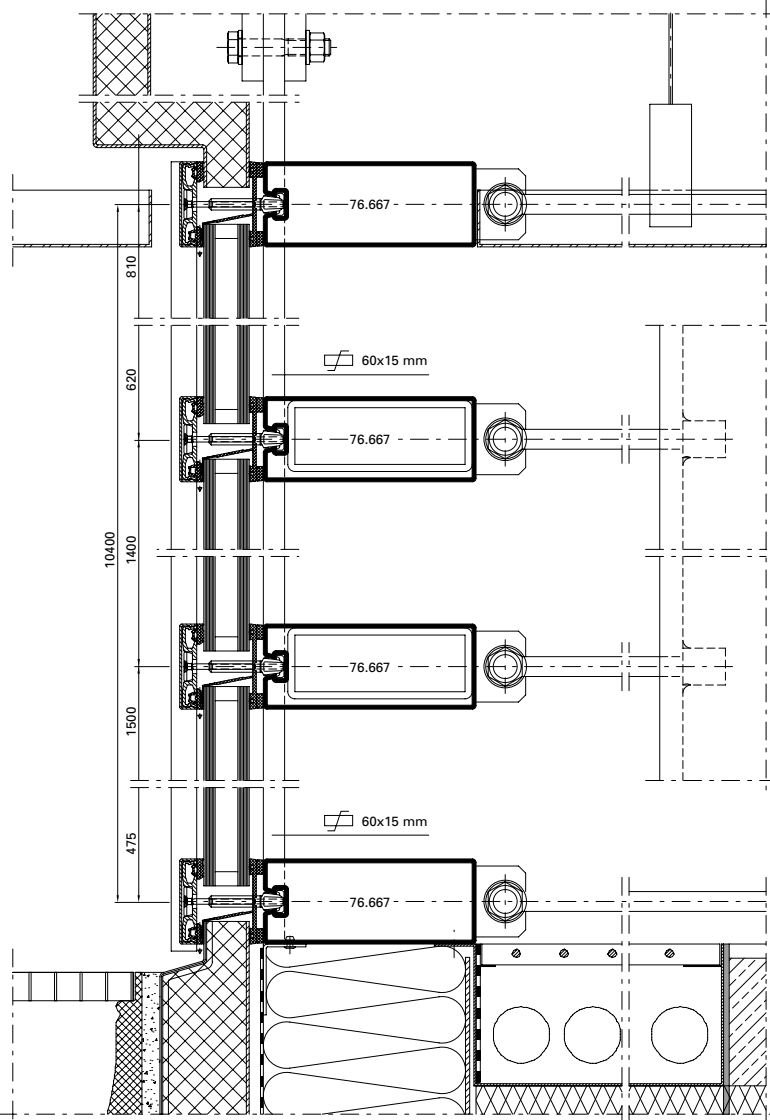

Ausgeführte Objekte

Objets réalisés

Completed projects

Objekt:

Ausbau Messehalle BEA Expo,
Bern/CH

System:

VISS Fire E30/EI30,
Jansen-Economy E30, Janisol 2 EI30

Architekt:

Schwaar & Partner AG, Bern/CH

Objet:

Agrandissement du hall d'exposition
BEA Expo, Berne/CH

Système:

VISS Fire E30/EI30,
Jansen-Economy E30, Janisol 2 EI30

Architecte:

Schwaar & Partner AG, Berne/CH

Project:

Exhibition hall extension BEA Expo,
Bern/CH

System:

VISS Fire E30/EI30,
Jansen-Economy E30, Janisol 2 EI30

Architect:

Schwaar & Partner AG, Bern/CH



Objekt:

MAN Nutzfahrzeuge, Werkserweiterung,
München/DE

System:

VISS I_xtra, Janisol Türen

Architekt:

DMP Architekten BDA, München/DE

Objet:

MAN Nutzfahrzeuge, agrandissement
de l'usine, Munich/DE

Système:

VISS I_xtra, portes Janisol

Architecte:

DMP Architekten BDA, Munich/DE

Project:

MAN Nutzfahrzeuge, plant extension,
Munich/DE

System:

VISS I_xtra, Janisol doors

Architect:

DMP Architekten BDA, Munich/DE



Ausgeführte Objekte Objets réalisés Completed projects

Objekt:

Museumsquartier, Den Bosch/NL

System:

VISS I_xtra TV

Architekt:

Bierman Henket Architecten, Esch/NL

Objet:

Quartier des musées, Den Bosch/NL

Système:

VISS I_xtra TV

Architecte:

Bierman Henket Architecten, Esch/NL

Project:

Museum Quarter, Den Bosch/NL

System:

VISS I_xtra TV

Architect:

Bierman Henket Architecten, Esch/NL



B - B

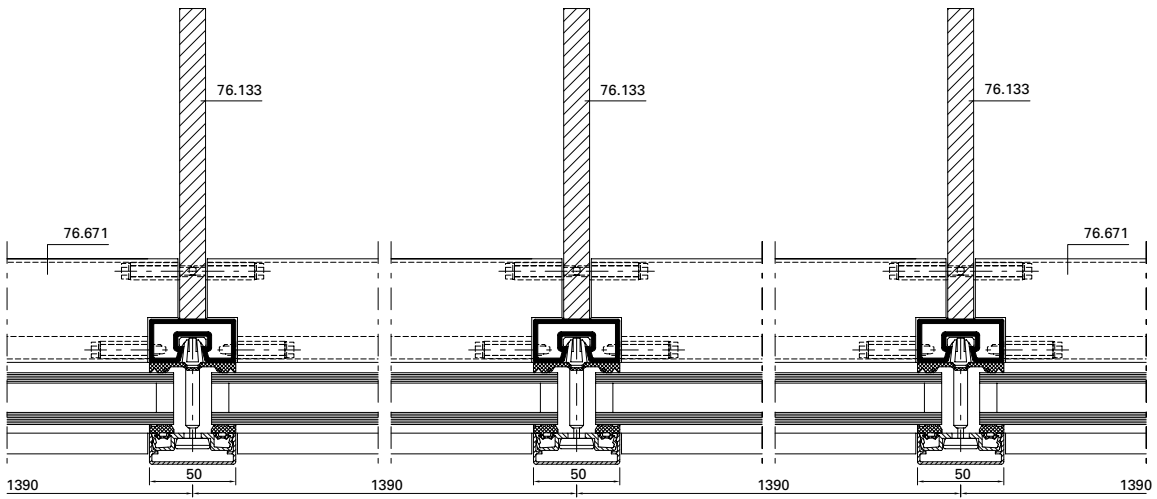

A - A

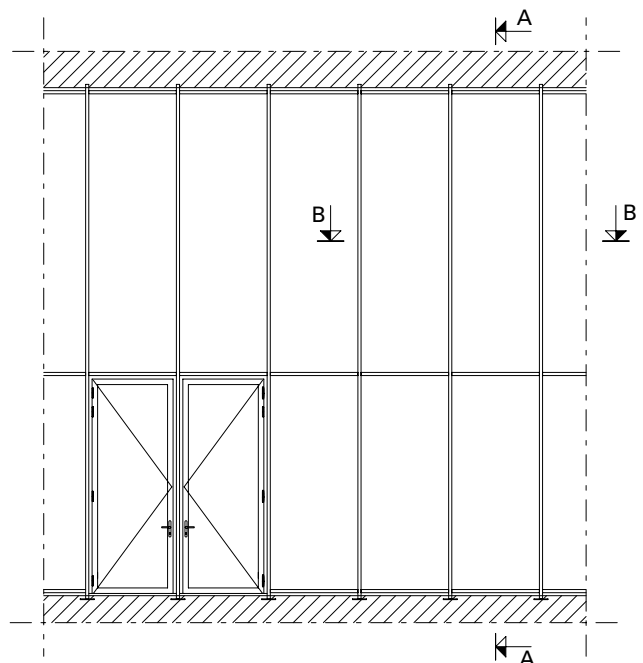
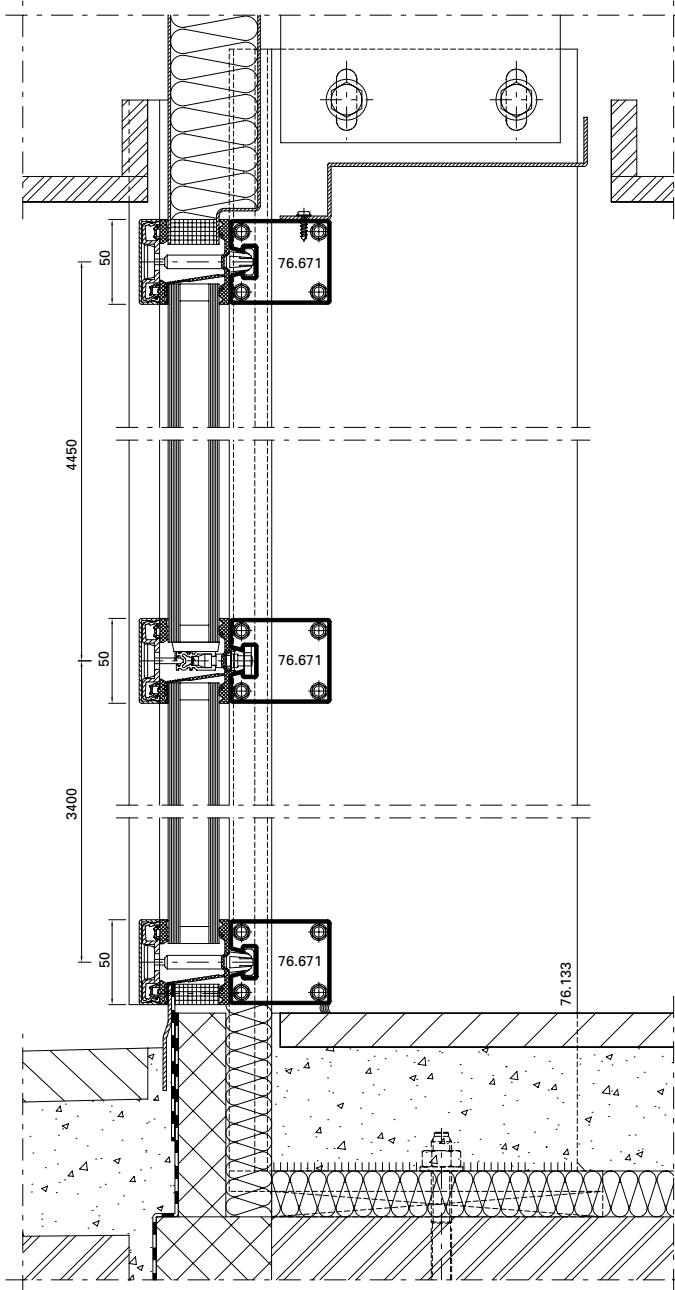

Ausgeführte Objekte Objets réalisés Completed projects

Objekt:

Werkhalle Glas Trösch,
St.Gallen/CH

System:

VISS TVS

Architekt:

Schuchter Ehle, Architekten, St.Gallen/
CH

Objet:

Atelier de Glas Trösch,
Saint-Gall/CH

Système:

VISS TVS

Architecte:

Schuchter Ehle, Architekten,
Saint-Gall/CH

Project:

Glas Trösch factory building,
St. Gallen/CH

System:

VISS TVS

Architect:

Schuchter Ehle, Architekten, St.Gallen/
CH





Objekt:

Voentorg Center,
Moskau/RU

System:

VISS TV, VISS Fire

Architekt:

Mosprojekt-2: Kolosnitsin Vladimir
Vasilyevich / Starikov Alexander
Fedorovich, Moskau/RU

Objet:

Centre Voentorg,
Moscou/RU

Système:

VISS TV, VISS Fire

Architecte:

Mosprojekt-2: Kolosnitsin Vladimir
Vasilyevich / Starikov Alexander
Fedorovich, Moscou/RU

Project:

Voentorg Center,
Moscow/RU

System:

VISS TV, VISS Fire

Architect:

Mosprojekt-2: Kolosnitsin Vladimir
Vasilyevich / Starikov Alexander
Fedorovich, Moscow/RU



Ausgeführte Objekte Objets réalisés Completed projects

Objekt:

Neue Messehalle
(Kielce Trade Fairs), Kielce/PL

System:

VISS TVS (vertikal und schräg),
Janisol 2 E130, Falttore

Architekt:

bsp Architekten: Barbara Średniawa,
Gliwice/PL

Objet:

Nouveau hall d'exposition
(Kielce Trade Fairs), Kielce/PL

Système:

VISS TVS (vertical et oblique),
Janisol 2 E130, Porte accordéon

Architecte:

bsp Architekten: Barbara Średniawa,
Gliwice/PL

Project:

New exhibition hall
(Kielce Trade Fairs), Kielce/PL

System:

VISS TVS (vertical and sloping),
Janisol 2 E130, Folding doors

Architect:

bsp Architekten: Barbara Średniawa,
Gliwice/PL



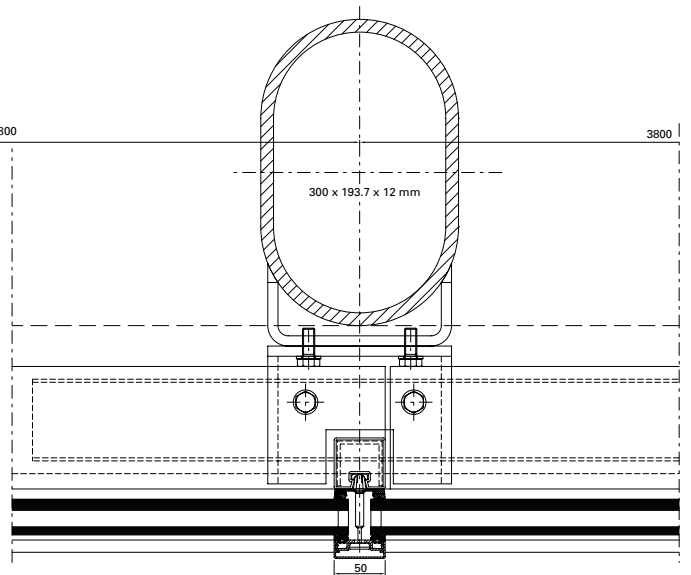
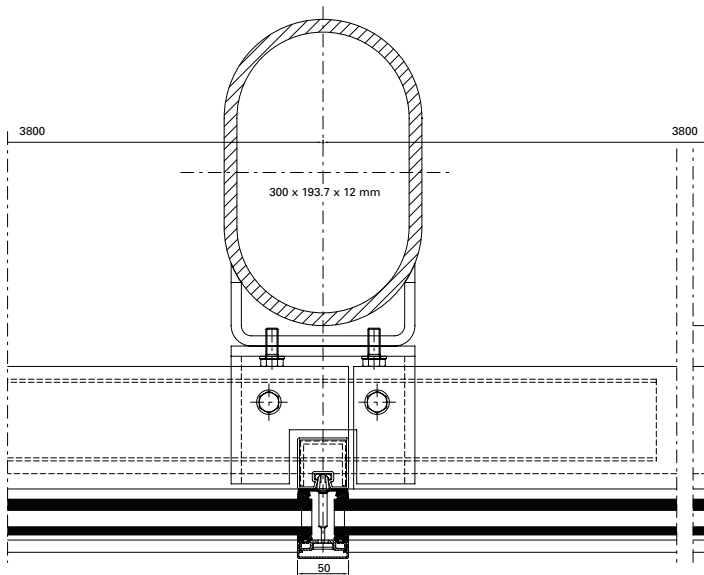
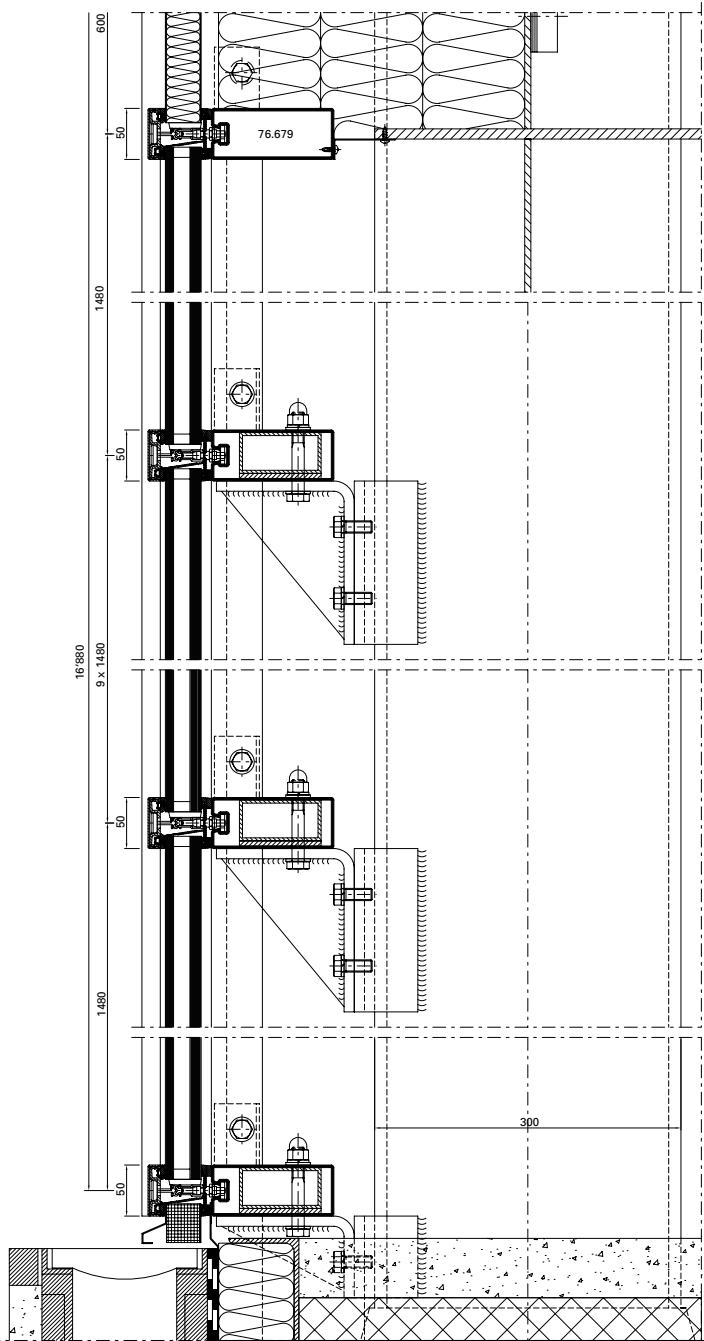

Jansen AG

Steel Systems
Industriestrasse 34
9463 Oberriet
Schweiz
jansen.com

JANSEN

Inhaltsverzeichnis

Sommaire

Content



3 Wissenschaftszentrum Kopernikus, Warschau/PL



4 Schloss Novy Svetlov, Bojkovice/CZ



5 Hotel Magyar Király, Székesfehérvár/HU



6 Theater- und Konzerthaus Kilden, Kristiansand/NO



8 Museum für moderne Kunst, Zagreb/HR



10 Museum für Kunst und Kulturgeschichte Altona, Hamburg-Altona/DE



11 TransPort (Flughafen Schiphol), Amsterdam/NL



12 Büro- und Geschäftshaus «Hillsite», Schwalbach am Taunus/DE



14 Zentralarchiv EDF, Bure/FR



16 Gemeindehaus, Ruidellots de la Selva/ES



17 Hauptbahnhof, Köln/DE



18 Universität Lausanne «Géopolis», Lausanne/CH



20 Jansen AG, Campus, Oberriet/CH



22 Bildungsforum, Potsdam/DE



24 Besucherzentrum «Alte Wasserzentrale», Pietra Neamt/RO



26 Hotel Novi Spa, Novi Vinodolski/HR



27 Solvias AG, Büro- und Lagergebäude, Kaiseraugst/CH



28 Médiathèque, Pau/FR



30 «Mumuth» Haus für Musik & Musiktheater der Kunstuniversität, Graz/AT



32 Centre Pompidou, Metz/FR



33 Alters- und Pflegeheim, Burgdorf/CH



34 Drents Museum, Assen/NL



36 Akustik-Tunnels, Warschau/PL



38 Jin Ji Hu Kempinski Hotel, Suzhou/CN



39 Historisches Museum, Kharkov/UA



40 Kunstgebäude, Stuttgart/DE



42 3-Feldsporthalle, Ingelfingen/DE



44 Musikkonservatorium, Bilbao/ES



45 Landesberufsschule, Mureck/AT



46 Hafencity Schule, Hamburg/DE



48 Drehrestaurant
«Hoher Kasten»,
Brülisau/CH



50 Hauptbahnhof
«Rotterdam Centraal»,
Rotterdam/NL



52 IGuzzini
Illuminazione,
Barcelona/ES



54 «Erasmus»
Studenten-Pavillon,
Rotterdam/NL



56 Hochschule
«Anstalt für
angewandte
Wissenschaften»,
Dessau/DE



57 Justizgebäude,
Würzburg/DE



58 Halle M, Jansen AG,
Oberriet/CH



60 Vogtlandhalle
(Stadthalle),
Greiz/DE



62 Ausbau Messehalle
BEA Expo,
Bern/CH



63 MAN Nutzfahrzeuge,
Werkserweiterung,
München/DE



64 Museumsquartier,
Den Bosch/NL



66 Werkhalle
Glas Trösch,
St.Gallen/CH



67 Voentorg Center,
Moskau/R



68 Neue Messehalle
(Kielce Trade Fairs),
Kielce/PL

Ausgeführte Objekte Objets réalisés Completed projects

JANSEN

Objekt:

Wissenschaftszentrum Kopernikus,
Centrum Nauki Kopernik, Warschau/PL

System:

VISS TVS, VISS SG, VISS Fire,
Janisol 2 EI30, Janisol SG

Architekt:

RAR-2 Laboratorium Architektury
Jan Kubec, Ruda Śląska/PL

Objet:

Centre de recherche Copernique,
Centrum Nauki Kopernik, Varsovie/PL

Système:

VISS TVS, VISS SG, VISS Fire,
Janisol 2 EI30, Janisol SG

Architecte:

RAR-2 Laboratorium Architektury
Jan Kubec, Ruda Śląska/PL

Project:

Copernicus Science Centre,
Centrum Nauki Kopernik, Warsaw/PL

System:

VISS TVS, VISS SG, VISS Fire,
Janisol 2 EI30, Janisol SG

Architect:

RAR-2 Laboratorium Architektury
Jan Kubec, Ruda Śląska/PL

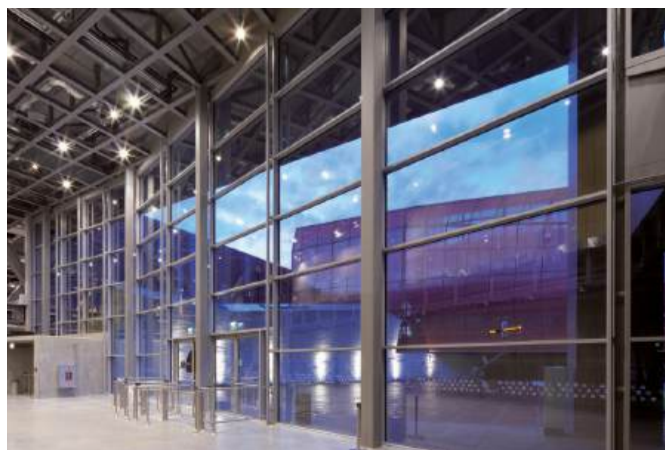

Ausgeführte Objekte
Objets réalisés
Completed projects



Objekt:

Schloss Novy Svetlov, Bojkovice/CZ

System:

VISS SG, VISS TVS (schräg)

Architekt:

Stavos s.r.o., Příbram/CZ

Objet:

Château Novy Svetlov, Bojkovice/CZ

Système:

VISS SG, VISS TVS (oblique)

Architecte:

Stavos s.r.o., Příbram/CZ

Project:

Novy Svetlov castle, Bojkovice/CZ

System:

VISS SG, VISS TVS (sloping)

Architect:

Stavos s.r.o., Příbram/CZ



Objekt:

Hotel Magyar Király,
Székesfehérvár/HU

System:

VISS TVS (schräg)

Architekt:

Szendro Epitesz Studio, Budapest/HU

Objet:

Hôtel Magyar Király,
Székesfehérvár/HU

Système:

VISS TVS (oblique)

Architecte:

Szendro Epitesz Studio, Budapest/HU

Project:

Hotel Magyar Király, Székesfehérvár/
HU

System:

VISS TVS (sloping)

Architect:

Szendro Epitesz Studio, Budapest/HU

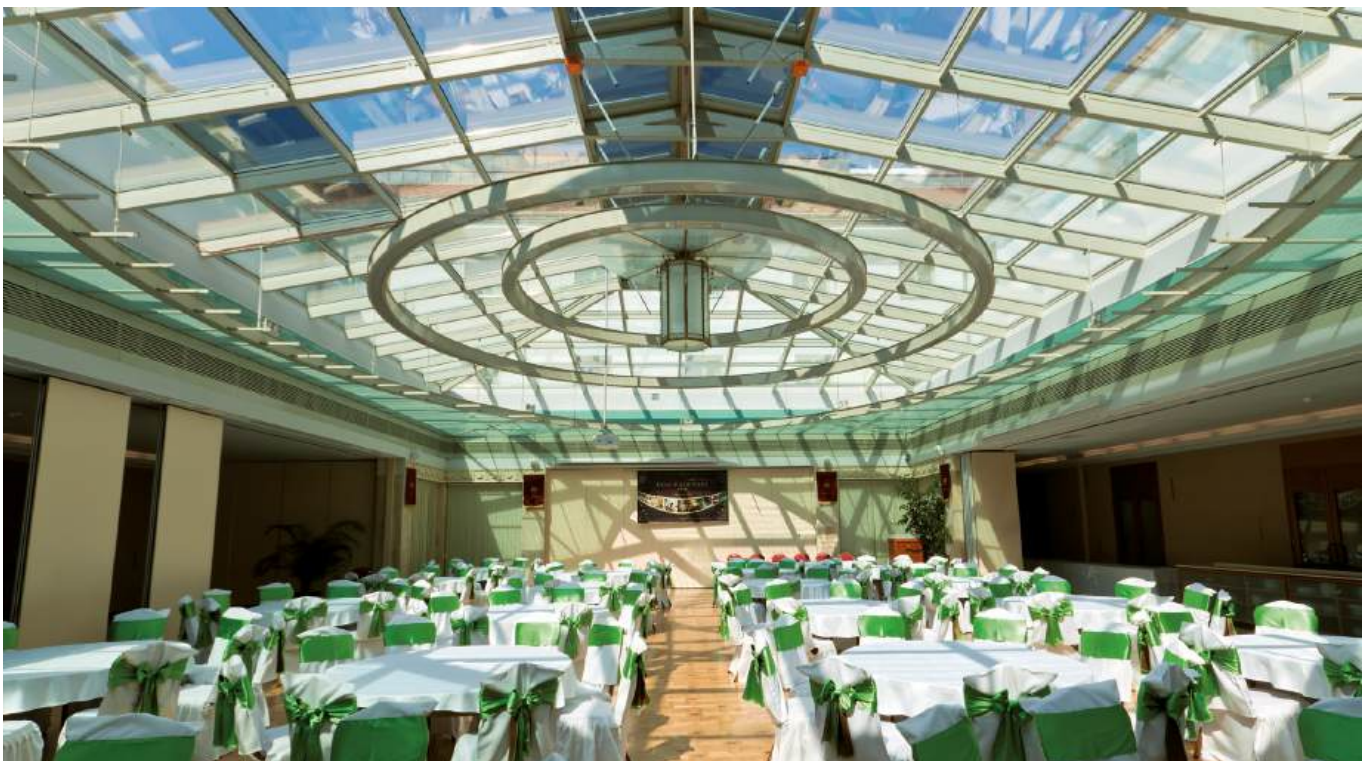

Ausgeführte Objekte

Objets réalisés

Completed projects

Objekt:

Theater- und Konzerthaus Kilden,
Kristiansand/NO

System:

VISS I_xtra

Architekt:

ALA Architects, Helsinki/SF

Objet:

Maison du théâtre et des concerts
Kilden, Kristiansand/NO

Système:

VISS I_xtra

Architecte:

ALA Architects, Helsinki/SF

Project:

Kilden Performing Arts Centre,
Kristiansand/NO

System:

VISS I_xtra

Architect:

ALA Architects, Helsinki/SF



Fotos: Jiri Havran, Oslo

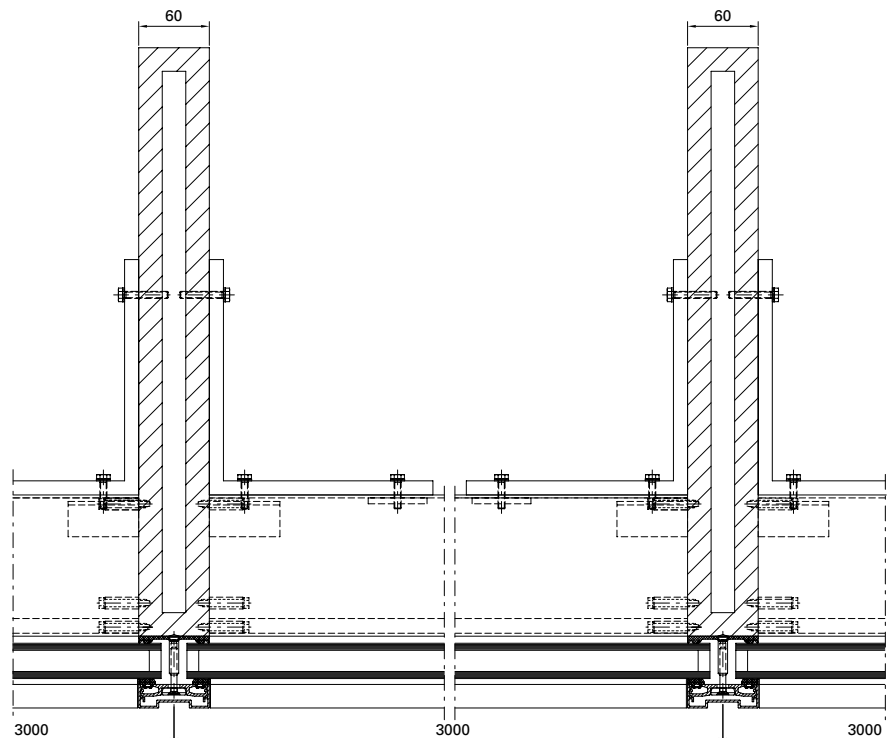
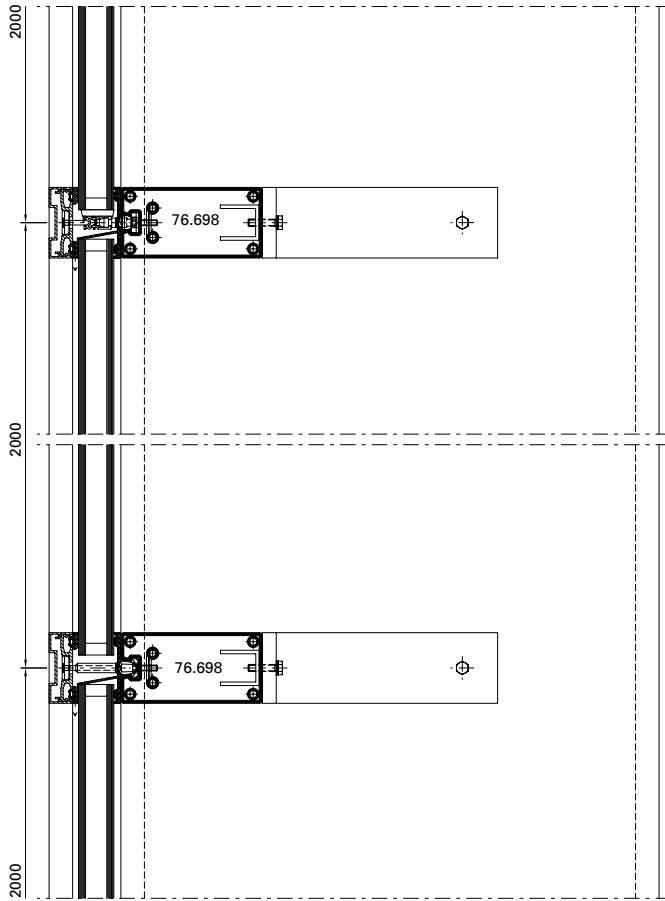

Ausgeführte Objekte

Objets réalisés

Completed projects

Objekt:

Museum für moderne Kunst, Zagreb/
HR

System:

VISS SG

Architekt:

Igor Franić Architekturstudio SZA,
Zagreb/HR

Objet:

Musée de l'art contemporain,
Zagreb/HR

Système:

VISS SG

Architecte:

Igor Franić Architekturstudio SZA,
Zagreb/HR

Project:

Museum of Contemporary Art, Zagreb/
HR

System:

VISS SG

Architect:

Igor Franić Architekturstudio SZA,
Zagreb/HR





Ausgeführte Objekte
Objets réalisés
Completed projects



Objekt:

Museum für Kunst und
Kulturgeschichte Altona,
Hamburg-Altona/DE

System:

VISS I_xtra, Janisol 2 EI30

Architekt:

Störmer Murphy and Partners GbR,
Hamburg/DE

Objet:

Musée de l'art et de l'histoire
de la civilisation Altona,
Hambourg-Altona/DE

Système:

VISS I_xtra, Janisol 2 EI30

Architecte:

Störmer Murphy and Partners GbR,
Hambourg/DE

Project:

Altona Museum of Art and
Cultural History Altona,
Hamburg-Altona/DE

System:

VISS I_xtra, Janisol 2 EI30

Architect:

Störmer Murphy and Partners GbR,
Hamburg/DE



Fotos: Jochen Helle, Dortmund

Objekt:

TransPort (Flughafen Schiphol),
Amsterdam/NL

System:

VISS Basic TVS Fire, VISS TVS

Architekt:

Architectenbureau Paul de Ruiter,
Amsterdam/NL

Objet:

TransPort (aéroport Schiphol),
Amsterdam/NL

Système:

VISS Basic TVS Fire, VISS TVS

Architecte:

Architectenbureau Paul de Ruiter,
Amsterdam/NL

Project:

TransPort (Schiphol airport),
Amsterdam/NL

System:

VISS Basic TVS Fire, VISS TVS

Architect:

Architectenbureau Paul de Ruiter,
Amsterdam/NL



Ausgeführte Objekte

Objets réalisés

Completed projects

Objekt:

Büro- und Geschäftshaus «Hillsite»,
Schwalbach am Taunus/DE

System:

VISS Semi SG

Architekt:

Meixner-Schlüter-Wendt Architekten,
Frankfurt am Main/DE

Objet:

Immeuble de bureaux et de commerce
«Hillsite», Schwalbach am Taunus/DE

Système:

VISS Semi SG

Architecte:

Meixner-Schlüter-Wendt Architekten,
Frankfurt am Main/DE

Project:

«Hillsite» office complex,
Schwalbach am Taunus/DE

System:

VISS Semi SG

Architect:

Meixner-Schlüter-Wendt Architekten,
Frankfurt am Main/DE

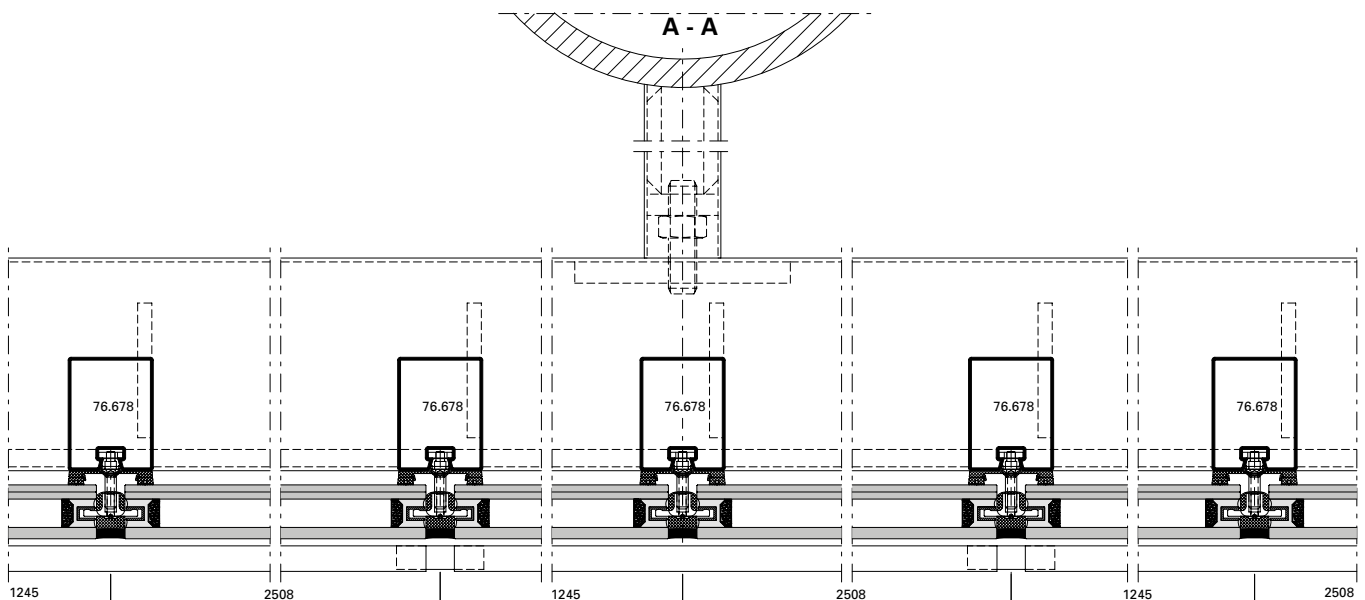

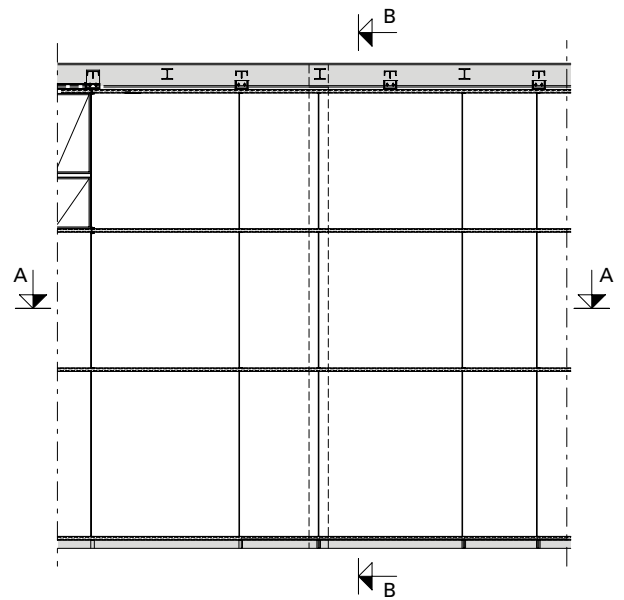
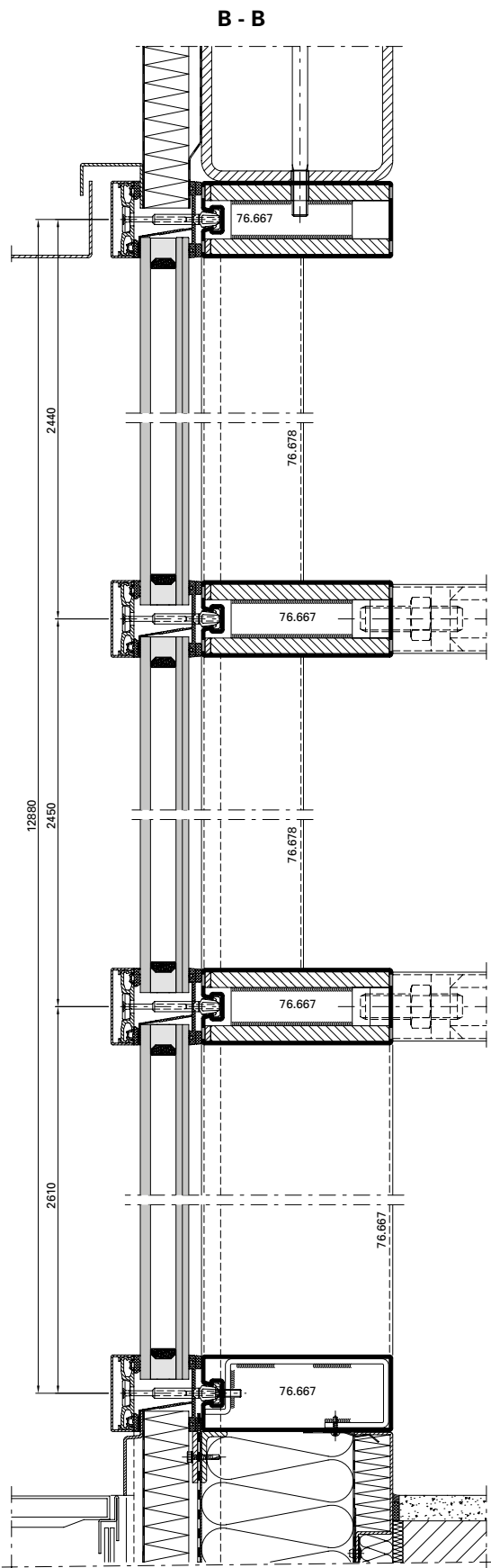

Ausgeführte Objekte Objets réalisés Completed projects

Objekt:

Zentralarchiv EDF, Bure/FR

System:

VISS TVS, Janisol Türen Edelstahl

Architekt:

LAN (Local Architecture Network),
Paris/FR

Objet:

Centre d'archives EDF, Bure/FR

Système:

VISS TVS, portes Janisol acier Inox

Architecte:

LAN (Local Architecture Network), Paris/
FR

Project:

Central archive EDF, Bure/FR

System:

VISS TVS, Janisol doors stainless steel

Architect:

LAN (Local Architecture Network),
Paris/FR

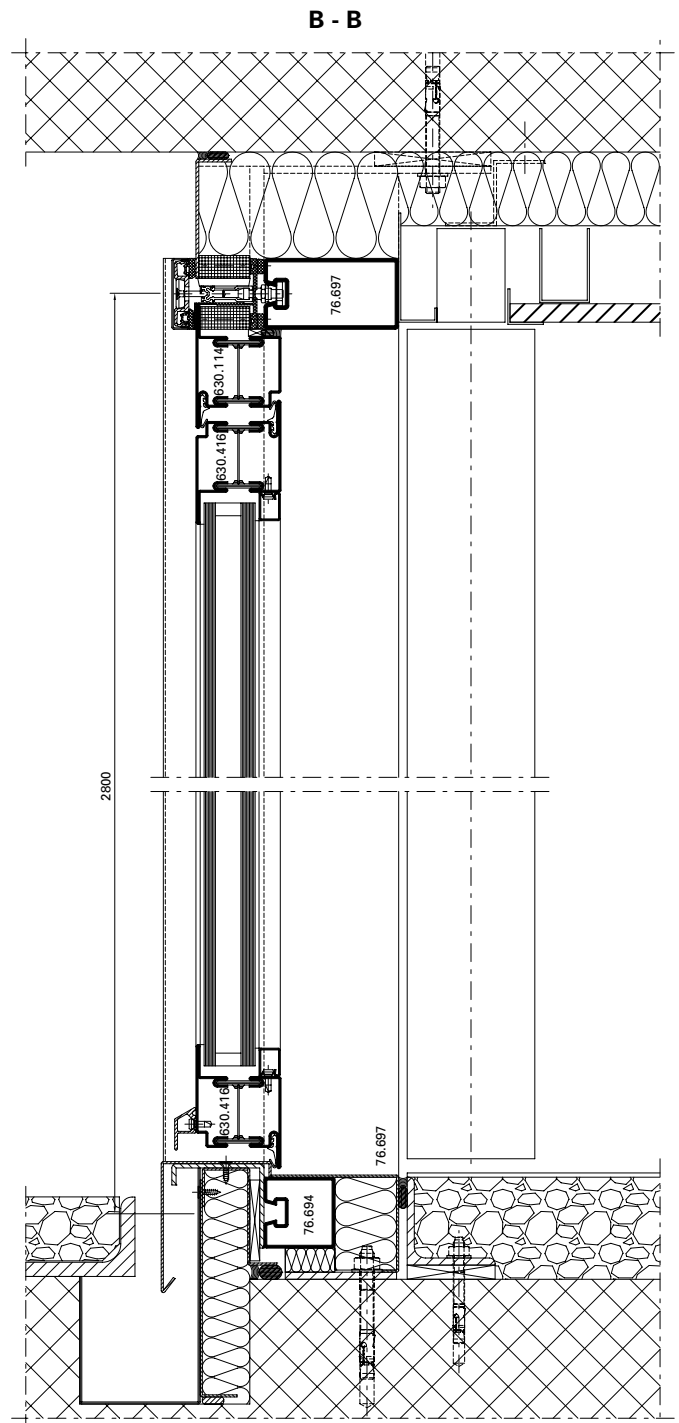

A - A

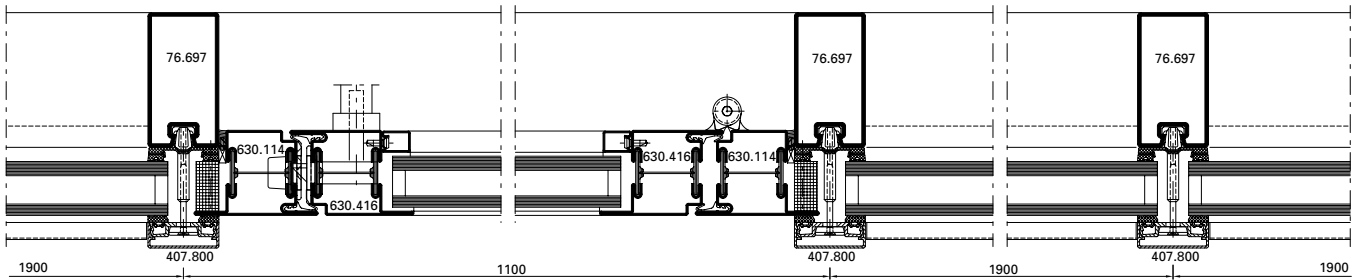

B

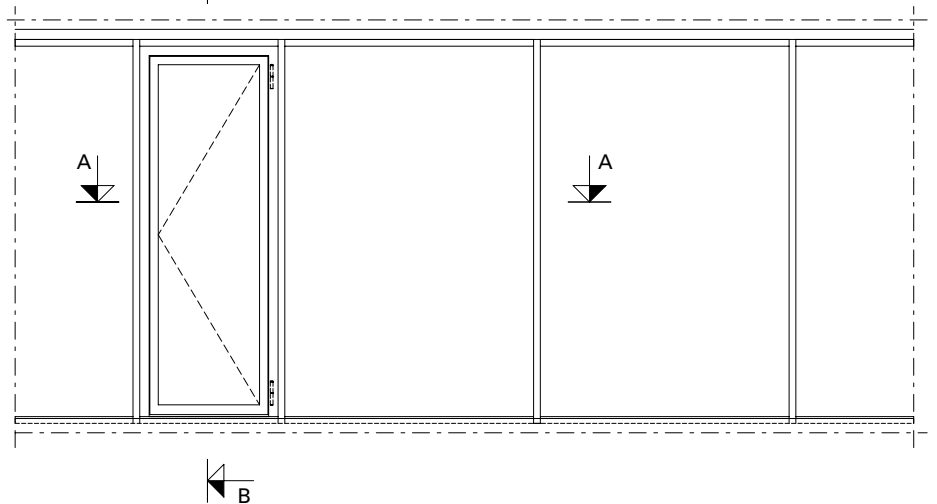

Ausgeführte Objekte

Objets réalisés

Completed projects

Objekt:

Gemeindehaus,
Ruidellots de la Selva/ES

System:

VISS TVS

Architekt:

Pla & Padrosa S.A., Girona/ES

Objet:

Hôtel de ville,
Ruidellots de la Selva/ES

Système:

VISS TVS

Architecte:

Pla & Padrosa S.A., Girona/ES

Project:

Town hall,
Ruidellots de la Selva/ES

System:

VISS TVS

Architect:

Pla & Padrosa S.A., Girona/ES

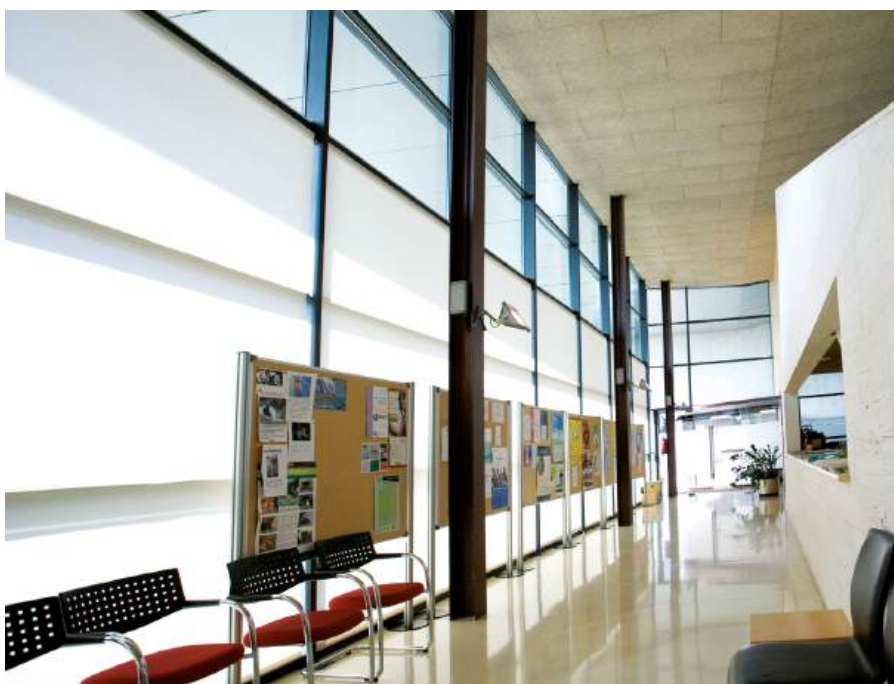

Objekt:

Hauptbahnhof, Köln/DE

System:

VISS TV, Jansen-Economy 50 Türen,
Janisol Türen Edelstahl

Architekt:

Kopka und Theil Architekten,
Dortmund/DE

Objet:

Gare centrale, Cologne/DE

Système:

VISS TV, portes Jansen-Economy 50,
portes Janisol acier Inox

Architecte:

Kopka und Theil Architekten,
Dortmund/DE

Project:

Central station, Cologne/DE

System:

VISS TV, Jansen-Economy 50 doors,
Janisol stainless steel doors

Architect:

Kopka und Theil Architekten,
Dortmund/DE



Fotos: Jochen Helle, Dortmund



Ausgeführte Objekte Objets réalisés Completed projects

Objekt:

UNIL, Universität Lausanne «Géopolis»,
Lausanne/CH

System:

VISS Fire, VISS TV, Janisol 2 EI30

Architekt:

Itten + Brechbühl Architekten,
Büro Lausanne, Lausanne/CH

Objet:

UNIL, Université de Lausanne
«Géopolis», Lausanne/CH

Système:

VISS Fire, VISS TV, Janisol 2 EI30

Architecte:

Itten + Brechbühl Architekten,
Büro Lausanne, Lausanne/CH

Project:

UNIL, University of Lausanne
«Géopolis», Lausanne/CH

System:

VISS Fire, VISS TV, Janisol 2 EI30

Architect:

Itten + Brechbühl Architekten,
Büro Lausanne, Lausanne/CH

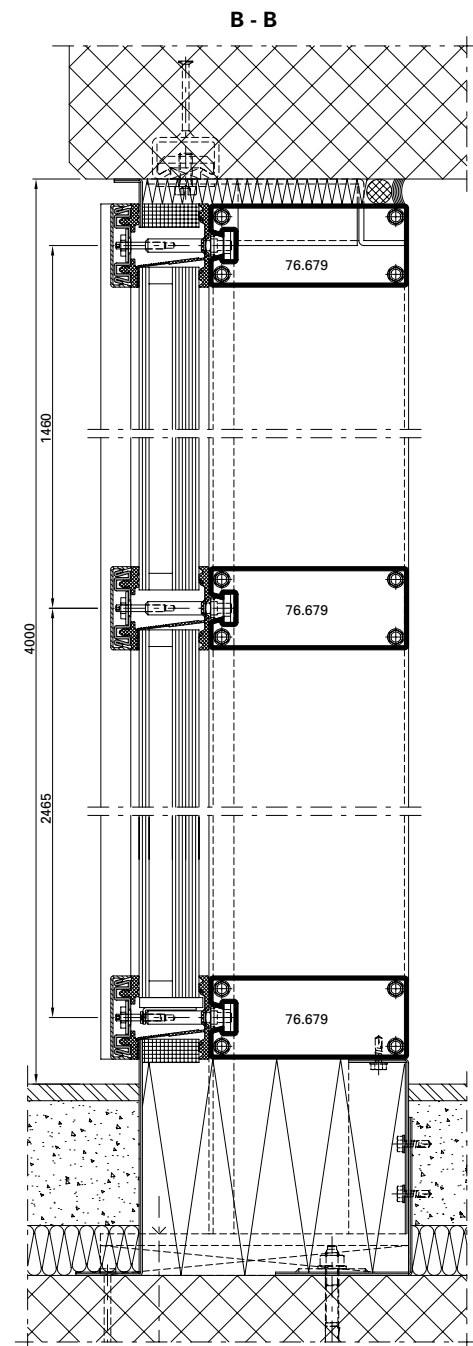

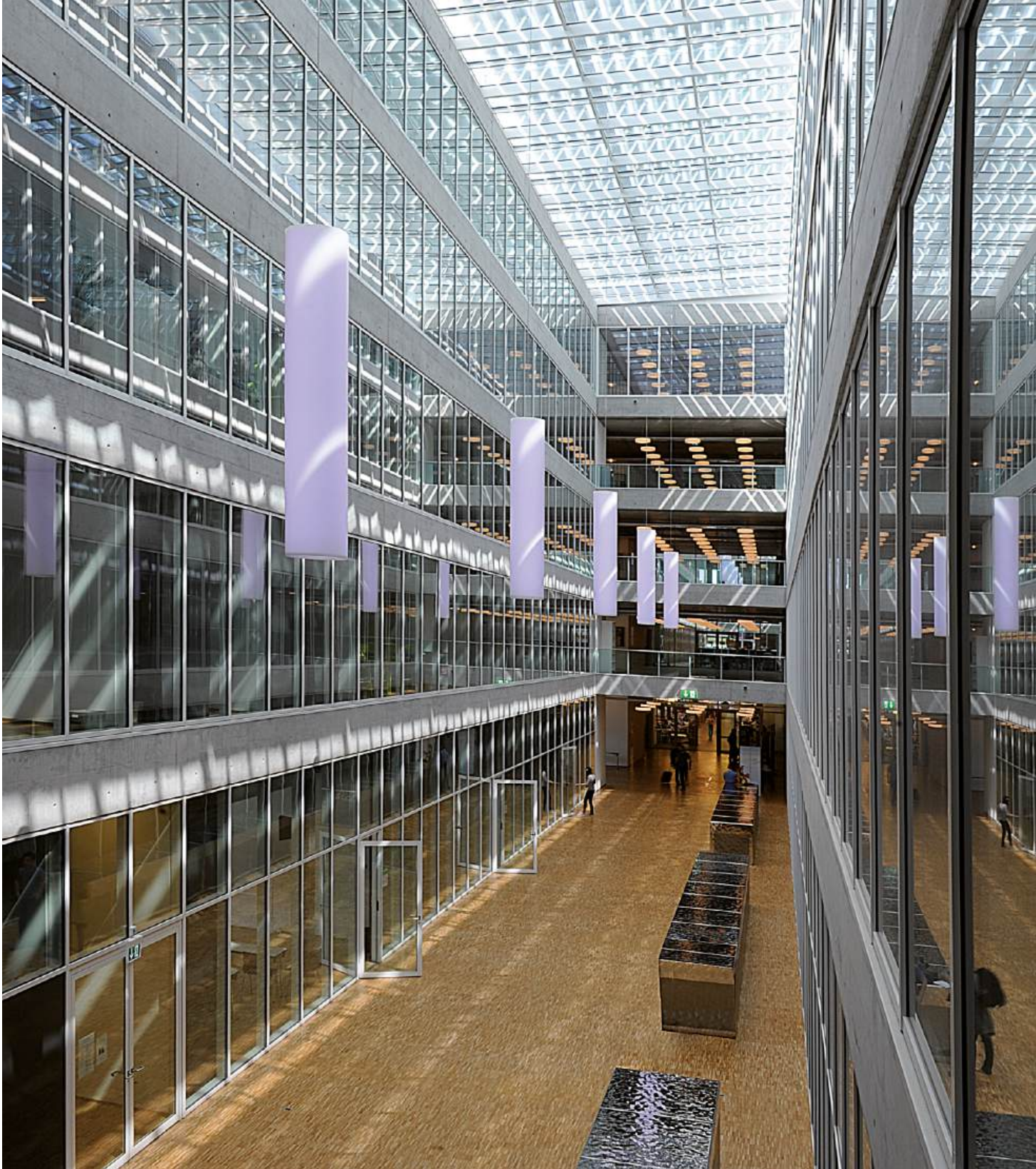

A - A

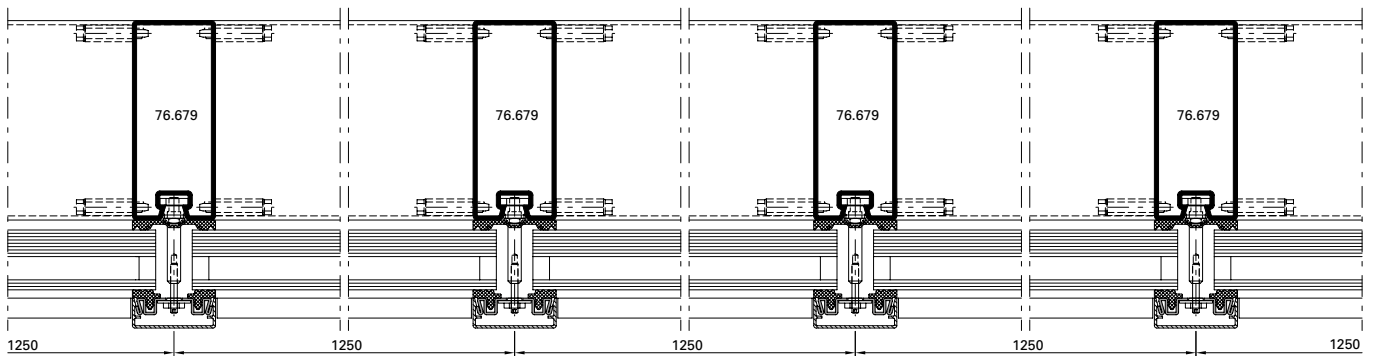

Ausgeführte Objekte

Objets réalisés

Completed projects

Objekt:

Jansen AG, Campus, Oberriet/CH

System:

VISS SG

Architekt:

Davide Macullo Architects, Lugano/CH

Objet:

Jansen AG, Campus, Oberriet/CH

Système:

VISS SG

Architecte:

Davide Macullo Architects, Lugano/CH

Project:

Jansen AG, Campus, Oberriet/CH

System:

VISS SG

Architect:

Davide Macullo Architects, Lugano/CH

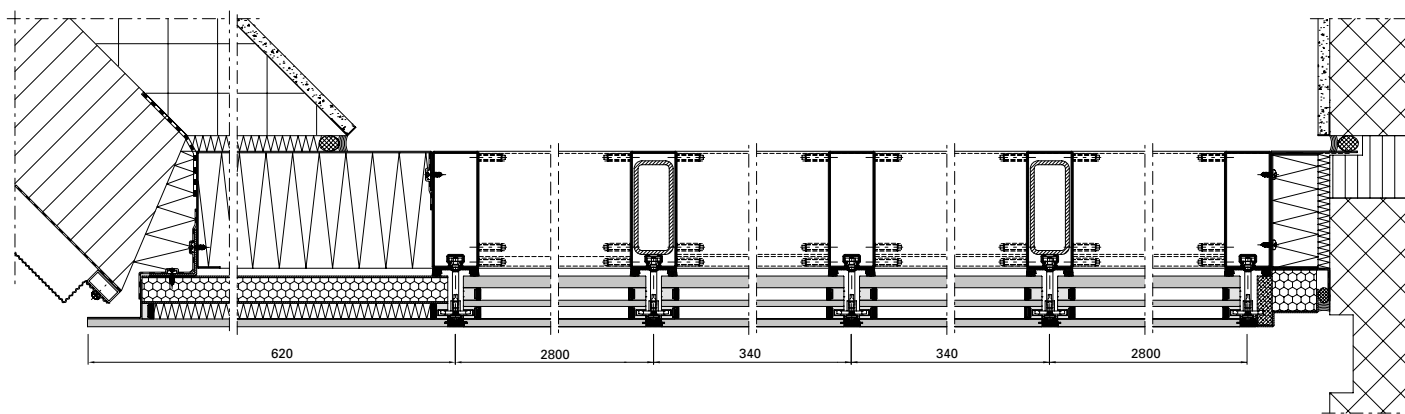

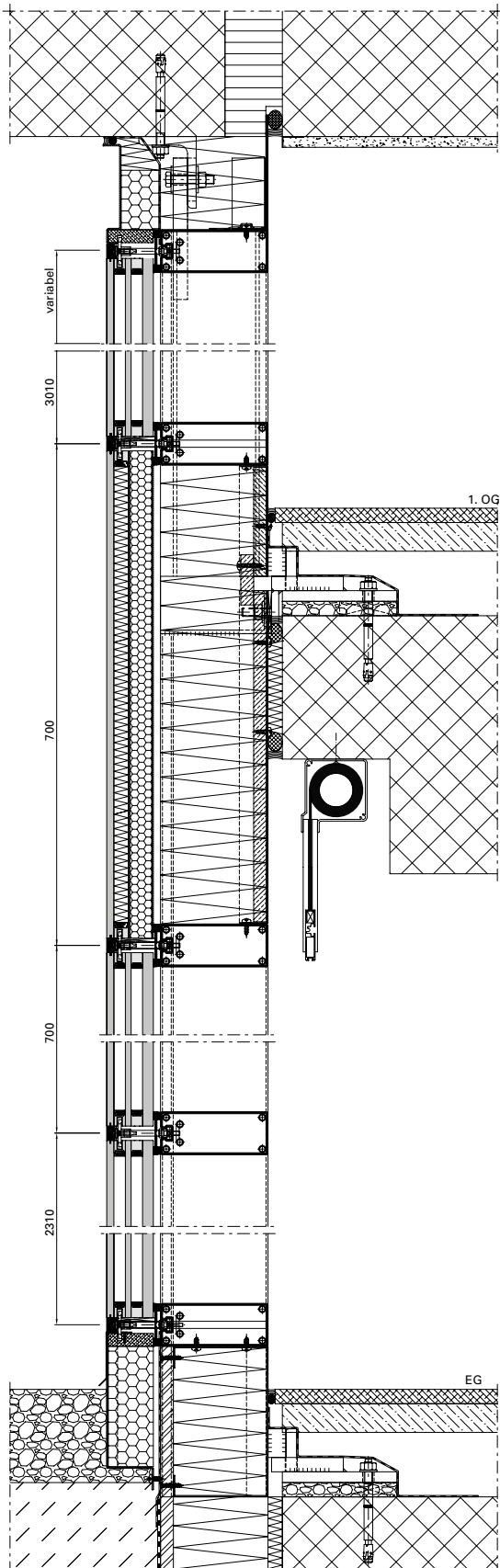

Ausgeführte Objekte

Objets réalisés

Completed projects

Objekt:

Bildungsforum, Potsdam/DE

System:

VISS TVS HI, VISS Fire

Architekt:

Reiner Becker Architekten BDA, Berlin/
DE

Objet:

Forum de formation, Potsdam/DE

Système:

VISS TVS HI, VISS Fire

Architecte:

Reiner Becker Architekten BDA, Berlin/
DE

Project:

Education forum, Potsdam/DE

System:

VISS TVS HI, VISS Fire

Architect:

Reiner Becker Architekten BDA, Berlin/
DE





Fotos: Stephan Falk, Berlin



Ausgeführte Objekte

Objets réalisés

Completed projects

Objekt:

Besucherzentrum «Alte Wasserzentrale», Pietra Neamt/RO

System:

VISS TVS

Architekt:

ZIP & BDX Studio, Marius Calin, Bukarest/RO

Objet:

Centre de visiteurs «ancienne centrale des eaux», Pietra Neamt/RO

Système:

VISS TVS

Architecte:

ZIP & BDX Studio, Marius Calin, Bukarest/RO

Project:

Visitor centre «old water station», Pietra Neamt/RO

System:

VISS TVS

Architect:

ZIP & BDX Studio, Marius Calin, Bukarest/RO

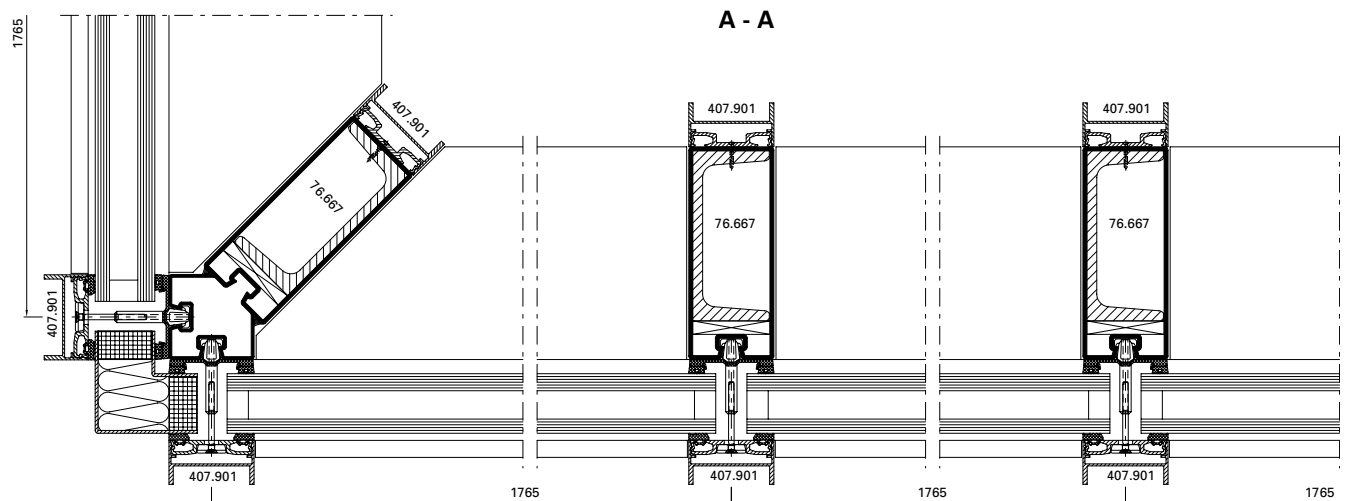

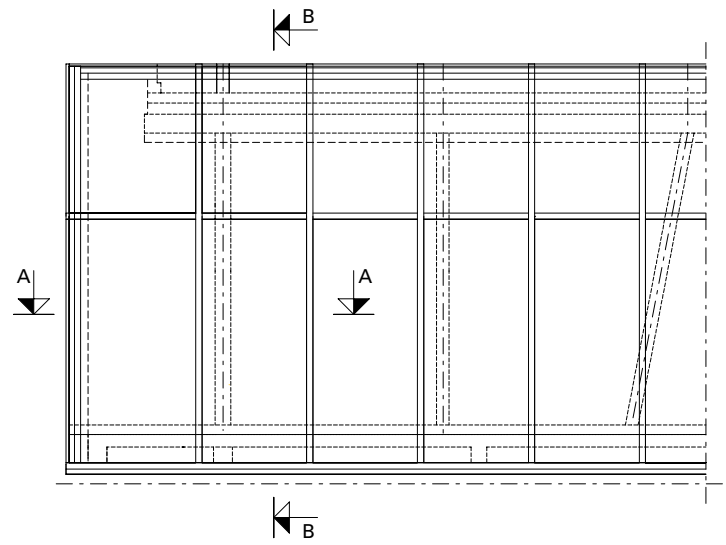
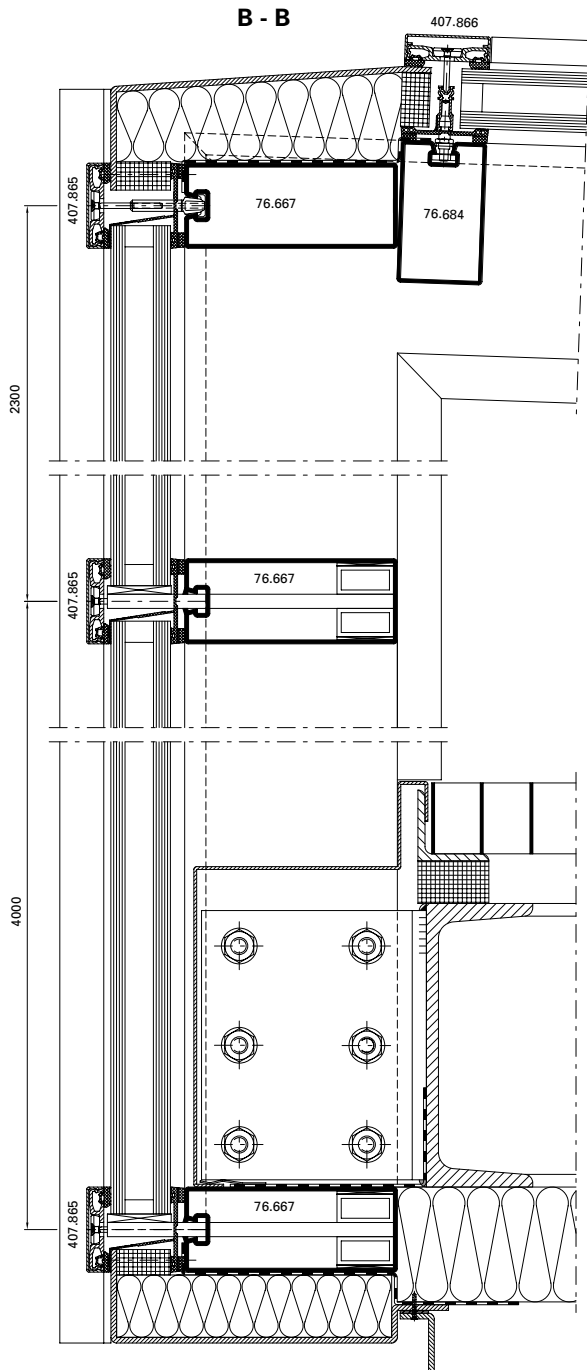

Ausgeführte Objekte

Objets réalisés

Completed projects

Objekt:

Hotel Novi Spa,
Novi Vinodolski/HR

System:

VISS TV Linea

Architekt:

Architekturstudio Banas und Cimas,
Rijeka/HR

Objet:

Hôtel Novi Spa,
Novi Vinodolski/HR

Système:

VISS TV Linea

Architecte:

Architekturstudio Banas und Cimas,
Rijeka/HR

Project:

Novi Spa Hotel,
Novi Vinodolski/HR

System:

VISS TV Linea

Architect:

Architekturstudio Banas und Cimas,
Rijeka/HR



Objekt:

Solvias AG, Büro- und Lagergebäude, Kaiseraugst/CH

System:

VISS TV Linea

Architekt:

Zwimpfer Partner Architekten, Basel/CH

Objet:

Solvias AG, immeuble de bureaux et d'entrepôt, Kaiseraugst/CH

Système:

VISS TV Linea

Architecte:

Zwimpfer Partner Architekten, Bâle/CH

Project:

Solvias AG, office and warehouse facility, Kaiseraugst/CH

System:

VISS TV Linea

Architect:

Zwimpfer Partner Architekten, Basle/CH



Ausgeführte Objekte

Objets réalisés

Completed projects

Objekt:

Médiathèque, Pau/FR

System:

VISS Fire EW60, VISS Basic,
Janisol 3 E160

Architekt:

CANAL, Paris/FR

Objet:

Médiathèque, Pau/FR

Système:

VISS Fire EW60, VISS Basic,
Janisol 3 E160

Architecte:

CANAL, Paris/FR

Project:

Médiathèque, Pau/FR

System:

VISS Fire EW60, VISS Basic,
Janisol 3 E160

Architect:

CANAL, Paris/FR



A - A

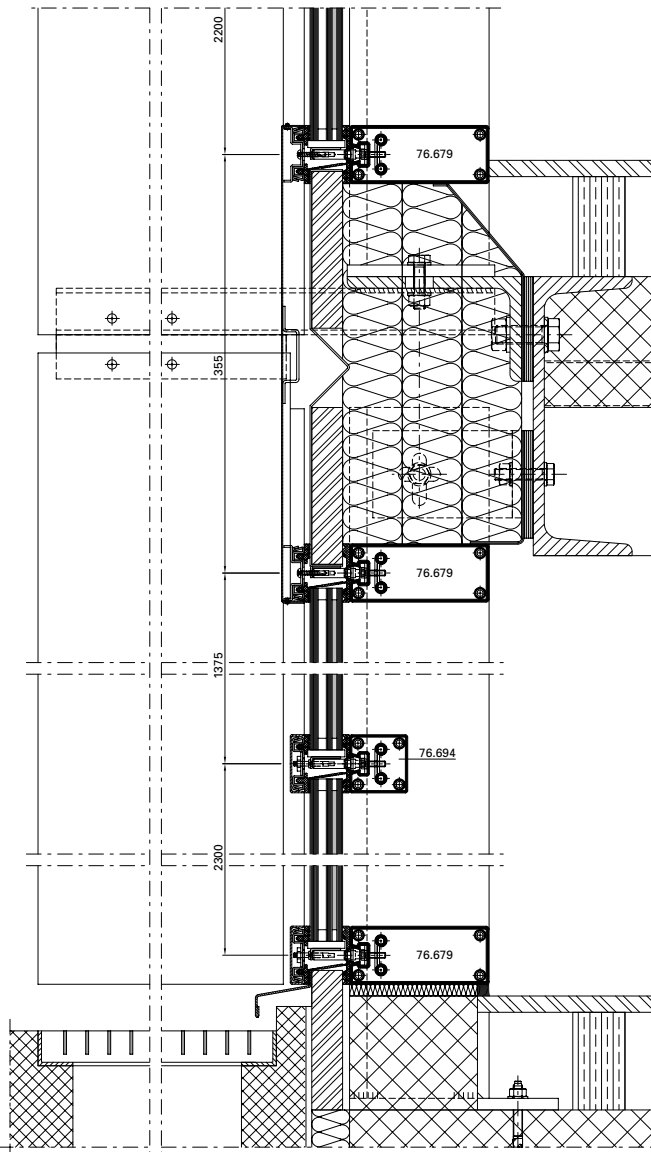

B - B

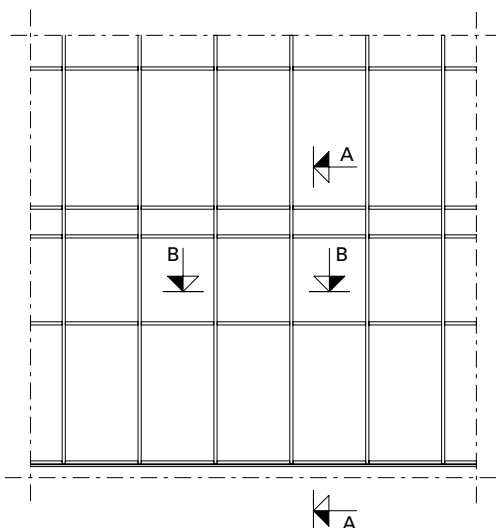
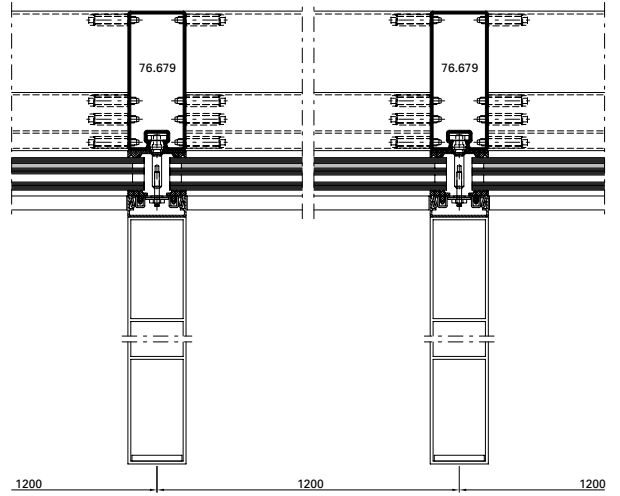

Ausgeführte Objekte Objets réalisés Completed projects

Objekt:

«Mumuth» Haus für Musik & Musiktheater der Kunstuniversität, Graz/AT

System:

VISS TVS

Architekt:

UNStudio, Arch. Ben van Berkel en Bos, Amsterdam/NL

Objet:

«Mumuth» Maison de la musique & du théâtre musical de l'université des arts, Grace/AT

Système:

VISS TVS

Architecte:

UNStudio, Arch. Ben van Berkel en Bos, Amsterdam/NL

Project:

«Mumuth» House of Music & Music Drama at the University of Music and Performing Arts, Graz/AT

System:

VISS TVS

Architect:

UNStudio, Arch. Ben van Berkel en Bos, Amsterdam/NL



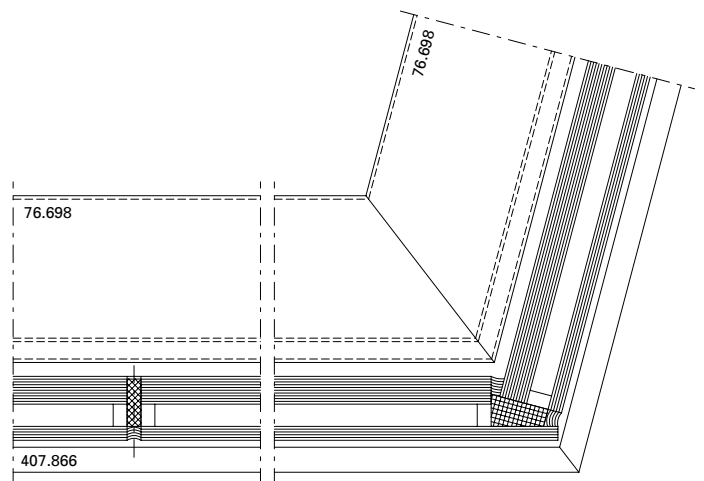
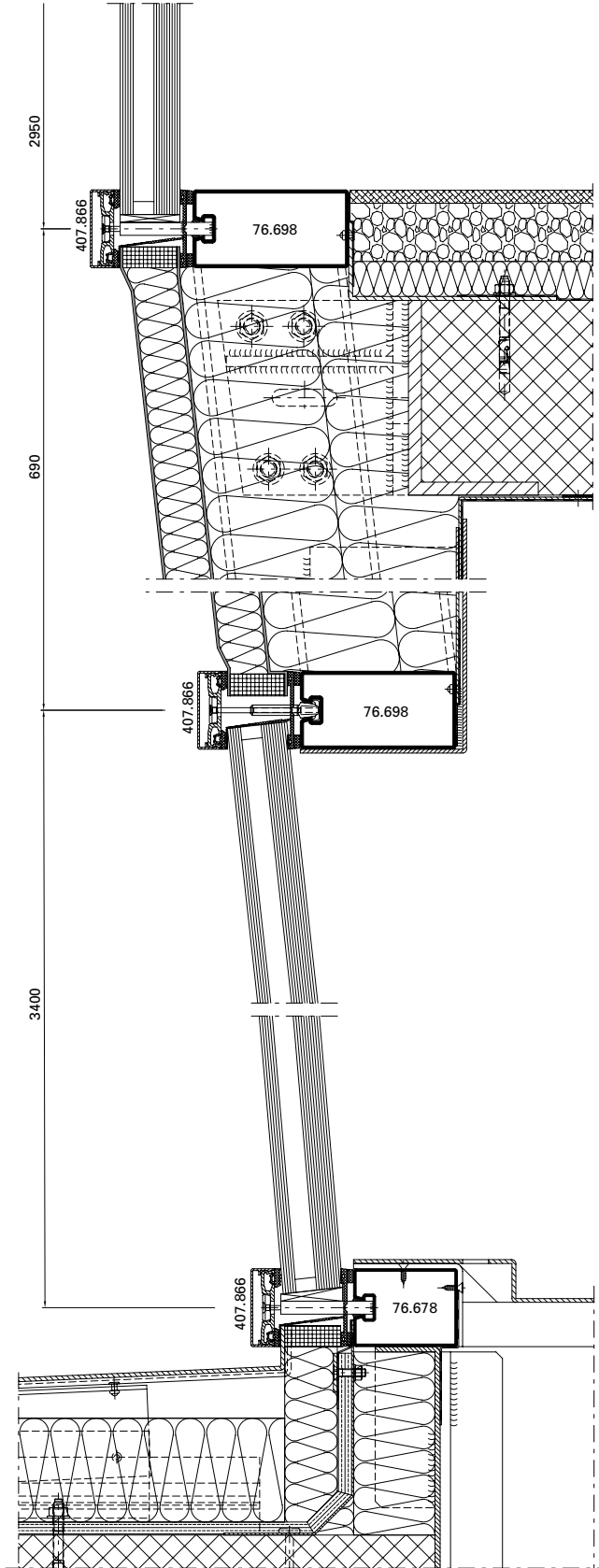

Ausgeführte Objekte
Objets réalisés
Completed projects



Project:

Centre Pompidou, Metz/FR

System:

VISS Fire EI60,
Jansen-Economy 50 E30

Architect:

Shigeru Ban Architects, Paris/FR

Objet:

Centre Pompidou, Metz/FR

Système:

VISS Fire EI60,
Jansen-Economy 50 E30

Architecte:

Shigeru Ban Architects, Paris/FR

Objekt:

Centre Pompidou, Metz/FR

System:

VISS Fire EI60,
Jansen-Economy 50 E30

Architekt:

Shigeru Ban Architects, Paris/FR



Objekt:

Alters- und Pflegeheim,
Burgdorf/CH

System:

VISS Basic TV

Architekt:

Gauer Itten Messerli Architekten AG,
Bern/CH

Objet:

Home pour personnes âgées, Burgdorf/
CH

Système:

VISS Basic TV

Architecte:

Gauer Itten Messerli Architekten AG,
Bern/CH

Project:

Old-age and nursing home, Burgdorf/
CH

System:

VISS Basic TV

Architect:

Gauer Itten Messerli Architekten AG,
Bern/CH

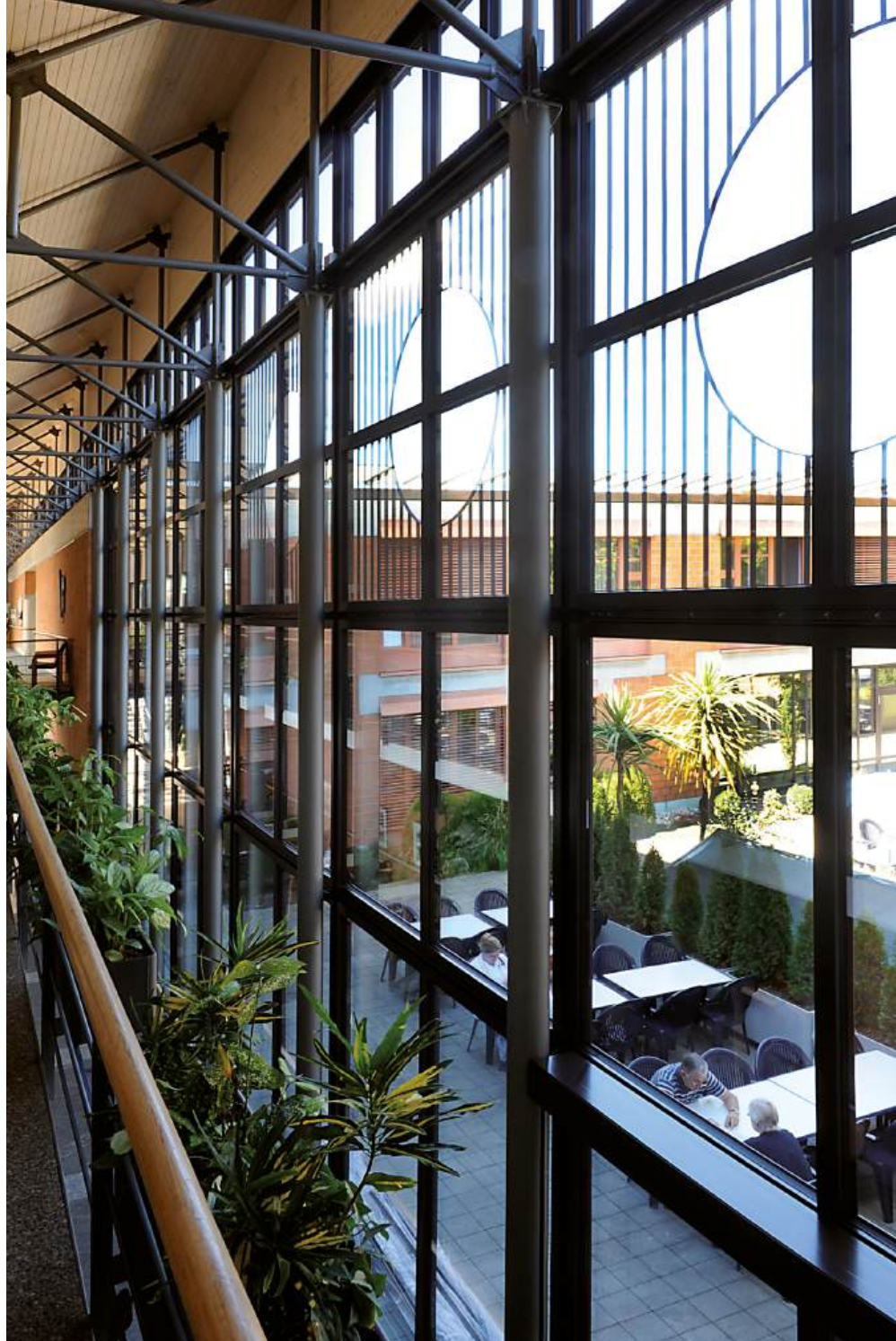

Ausgeführte Objekte

Objets réalisés

Completed projects

Objekt:

Drents Museum, Assen/NL

System:

VISS Basic TV,
Jansen-Economy 50 EW60

Architekt:

Designed by Erick van Egeraat,
Rotterdam/NL

Objet:

Musée Drents, Assen/NL

Système:

VISS Basic TV,
Jansen-Economy 50 EW60

Architecte:

Designed by Erick van Egeraat,
Rotterdam/NL

Project:

Drents Museum, Assen/NL

System:

VISS Basic TV,
Jansen-Economy 50 EW60

Architect:

Designed by Erick van Egeraat,
Rotterdam/NL



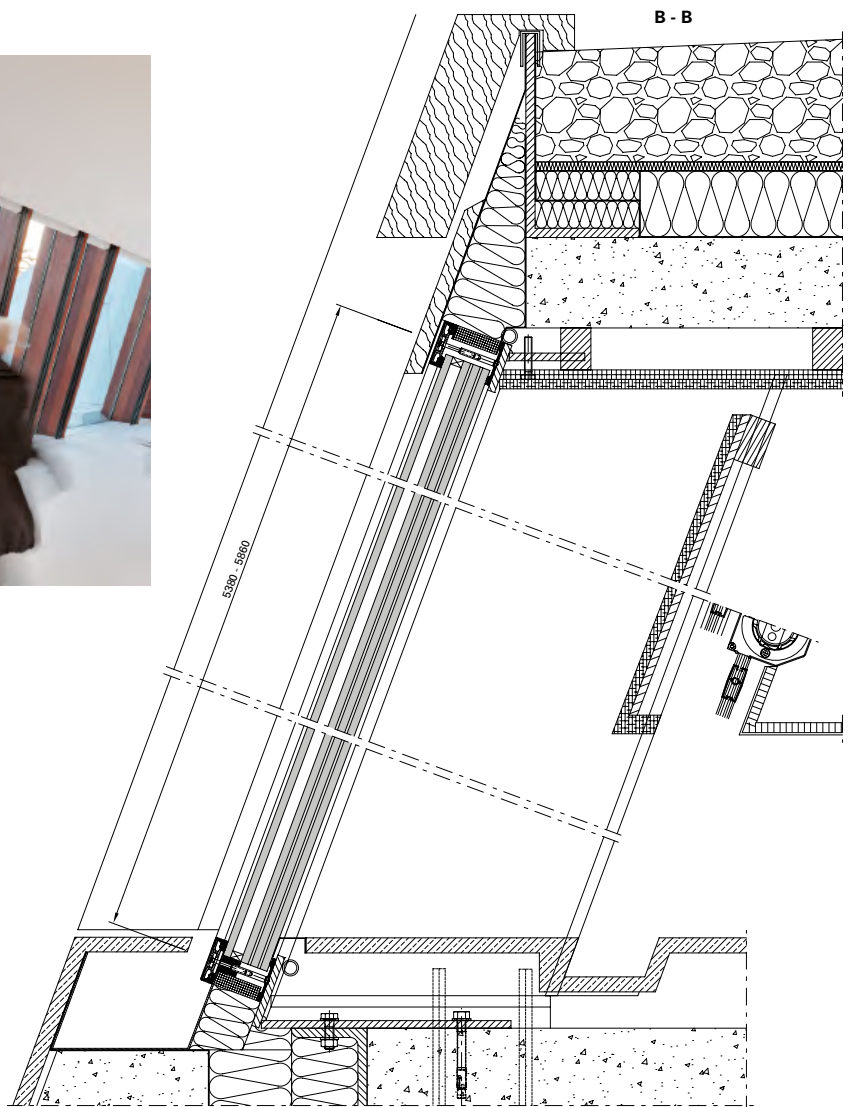
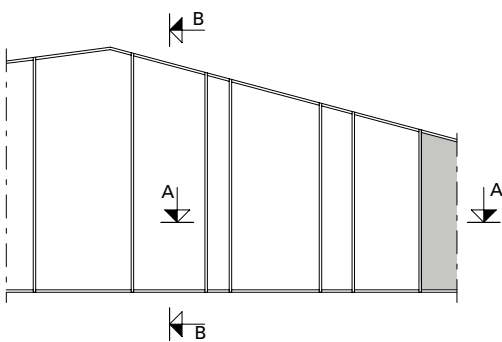
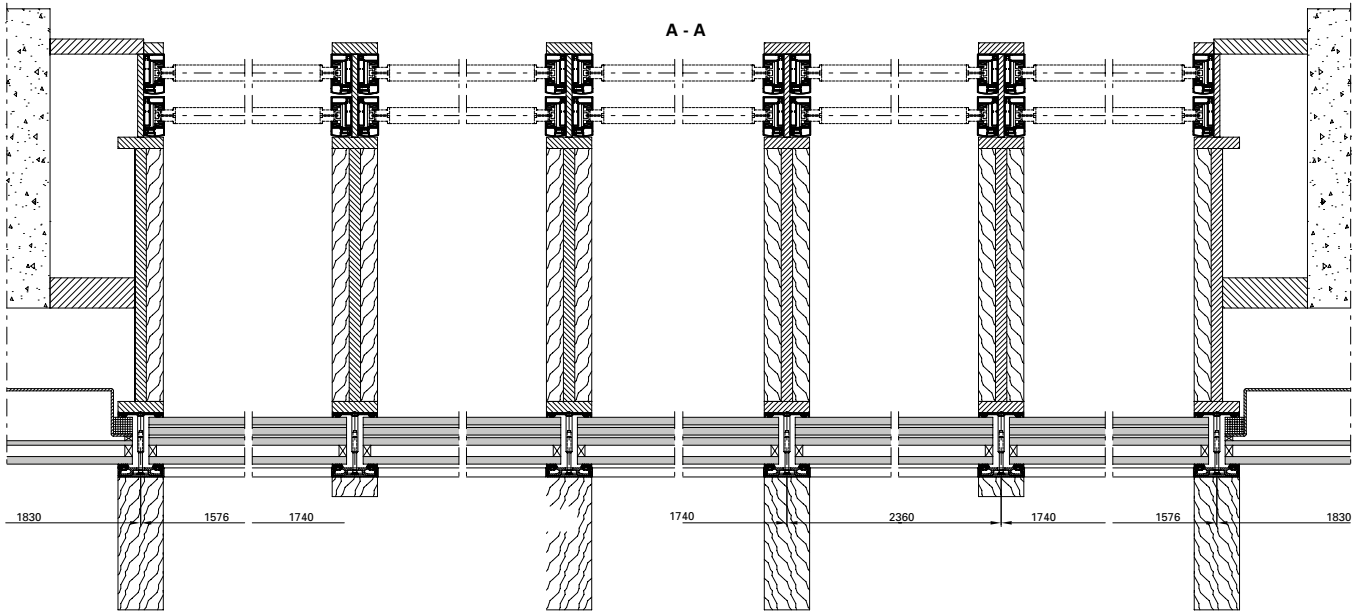

Ausgeführte Objekte Objets réalisés Completed projects

Objekt:

Akkustik-Tunnels,
Warschau/PL

System:

VISS Basic TVS (schräg)

Architekt:

Transprojekt, Warschau/PL
FOROOM Bartłomiej Grotte,
Warschau/PL

Objet:

Tunnels acoustiques,
Varsovie/PL

Système:

VISS Basic TVS (oblique)

Architecte:

Transprojekt, Varsovie/PL
FOROOM Bartłomiej Grotte,
Varsovie/PL

Project:

Acoustic tunnels,
Warsaw/PL

System:

VISS Basic TVS (sloping)

Architect:

Transprojekt, Warsaw/PL
FOROOM Bartłomiej Grotte,
Warsaw/PL

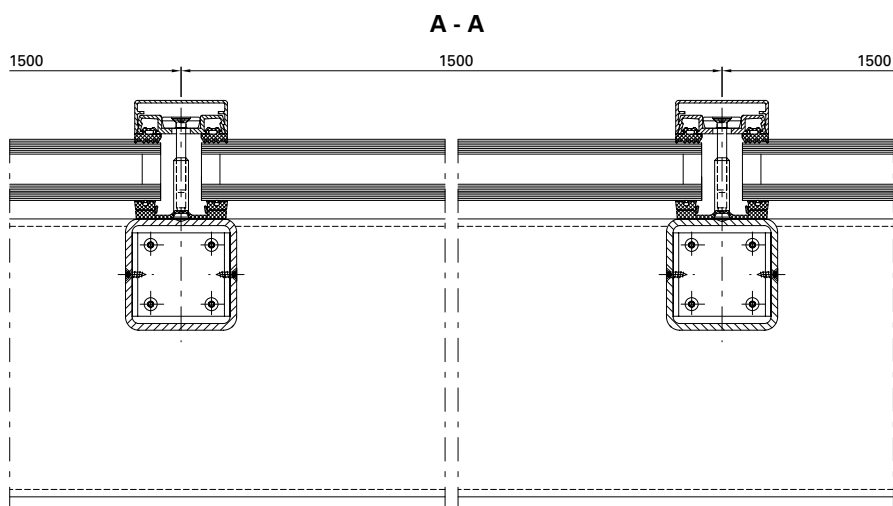

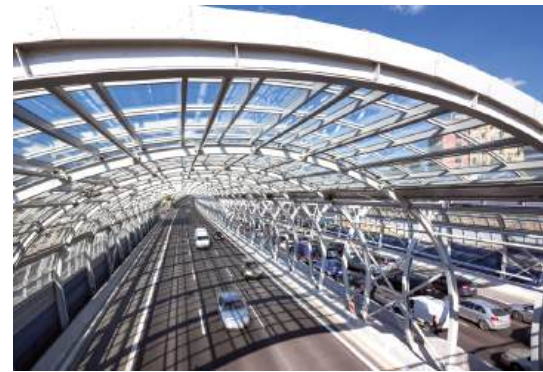
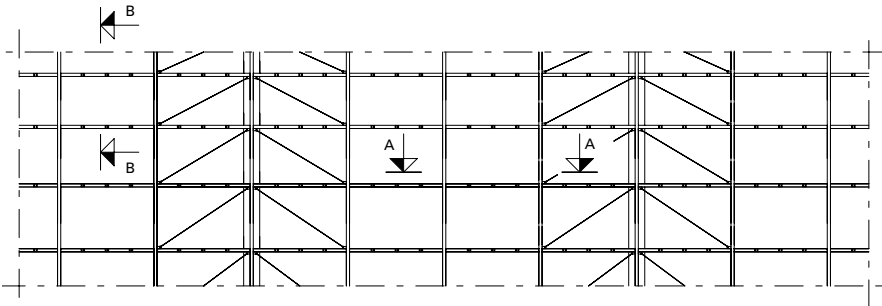
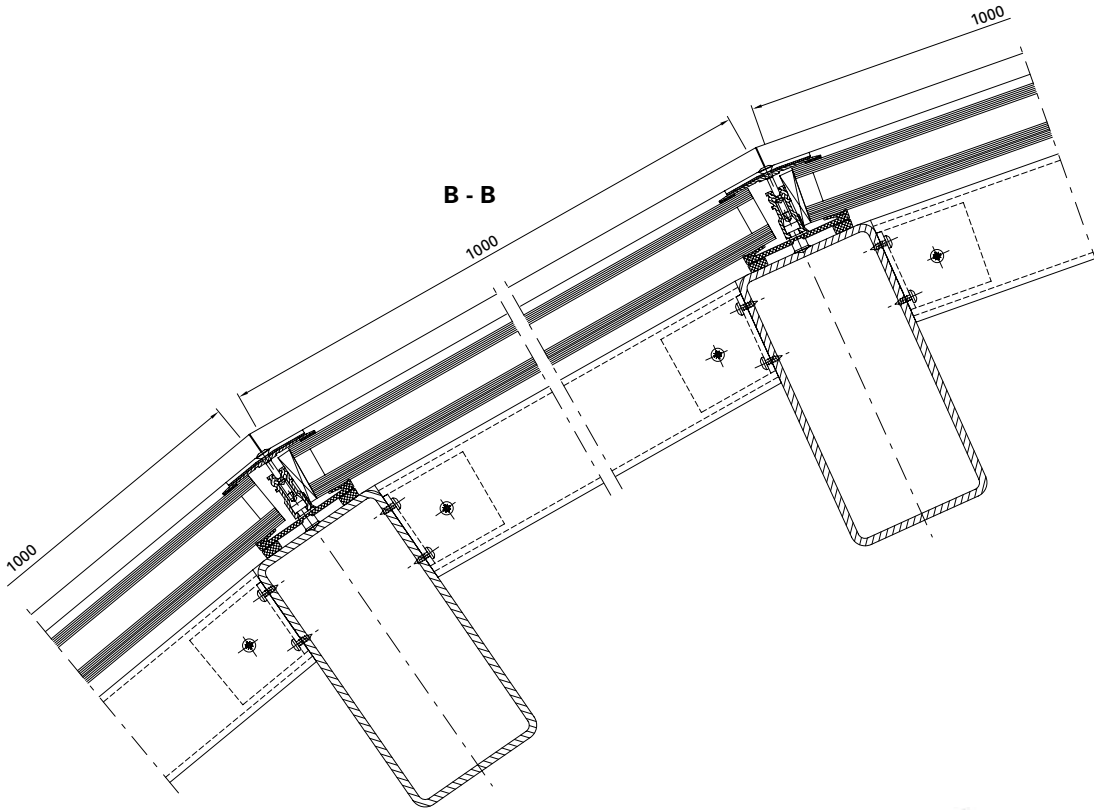

Ausgeführte Objekte
Objets réalisés
Completed projects

Objekt:

Jin Ji Hu Kempinski Hotel, Suzhou/CN

System:

VISS TV

Architekt:

Suzhou Architecture and Design
Institute, Shanghai/CN

Objet:

Hôtel Jin Ji Hu Kempinski, Suzhou/CN

Système:

VISS TV

Architecte:

Suzhou Architecture and Design
Institute, Shanghai/CN

Project:

Jin Ji Hu Kempinski Hotel, Suzhou/CN

System:

VISS TV

Architect:

Suzhou Architecture and Design
Institute, Shanghai/CN



Objekt:

Historisches Museum,
Kharkov/UA

System:

VISS I_xtra, Janisol Türen

Architekt:

S. Chechelnytskiy, M. Polivanova,
T. Polivanova, Kharkov/UA

Objet:

Musée historique,
Kharkov/UA

Système:

VISS I_xtra, portes Janisol

Architecte:

S. Chechelnytskiy, M. Polivanova,
T. Polivanova, Kharkov/UA

Project:

Historical museum,
Kharkov/UA

System:

VISS I_xtra, Janisol doors

Architect:

S. Chechelnytskiy, M. Polivanova,
T. Polivanova, Kharkov/UA

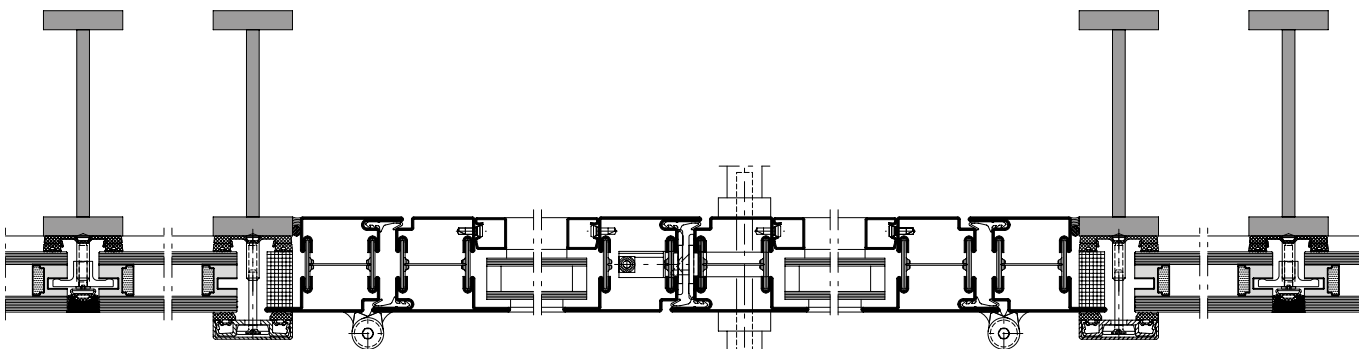

Ausgeführte Objekte

Objets réalisés

Completed projects

Objekt:

Kunstgebäude, Stuttgart/DE

System:

VISS TVS (schräg)

Architekt:

Harder III Stumpf, Freie Architekten,
Stuttgart/DE

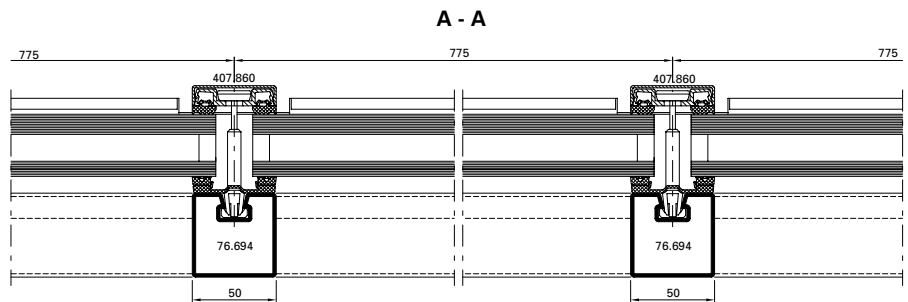
**Objet:**

Bâtiment des arts, Stuttgart/DE

Système:

VISS TVS (oblique)

Architecte:

Harder III Stumpf, Freie Architekten,
Stuttgart/DE

Project:

Art building, Stuttgart/DE

System:

VISS TVS (sloping)

Architect:

Harder III Stumpf, Freie Architekten,
Stuttgart/DE



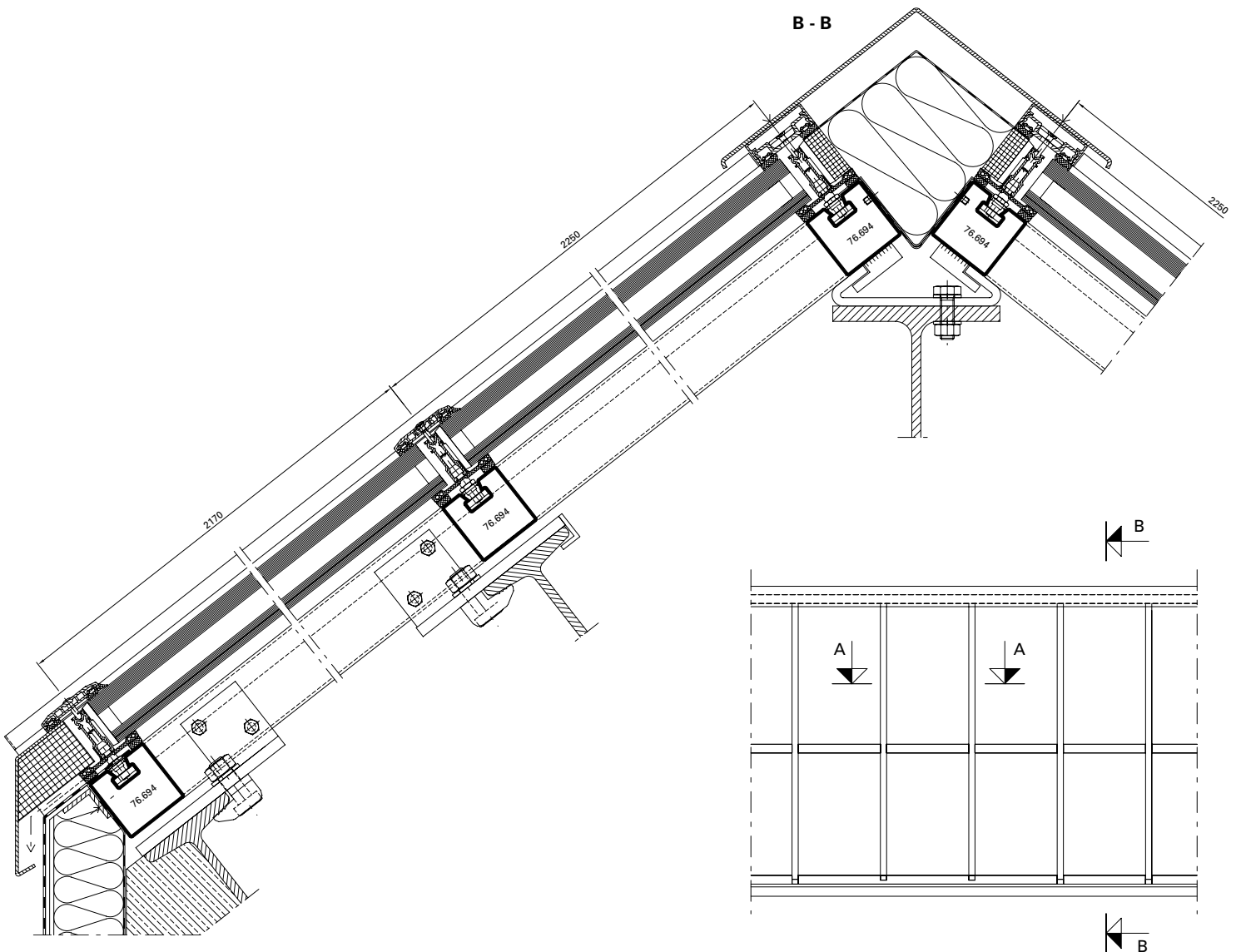

Ausgeführte Objekte

Objets réalisés

Completed projects

Objekt:

3-Feldsporthalle, Ingelfingen/DE

System:

VISS TVS HI, VISS Fire E30/E90, Janisol Primo, Janisol Türen, Janisol 2 E130, Jansen-Economy 60

Architekt:

Hein, Hüttel und Lindenberger, Ludwigsburg/DE

Objet:

Salle de sport triple, Ingelfingen/DE

Système:

VISS TVS HI, VISS Fire E30/E90, Janisol Primo, portes Janisol, Janisol 2 E130, Jansen-Economy 60

Architecte:

Hein, Hüttel und Lindenberger, Ludwigsburg/DE

Project:

3-field sports hall, Ingelfingen/DE

System:

VISS TVS HI, VISS Fire E30/E90, Janisol Primo, Janisol doors, Janisol 2 E130, Jansen-Economy 60

Architect:

Hein, Hüttel und Lindenberger, Ludwigsburg/DE

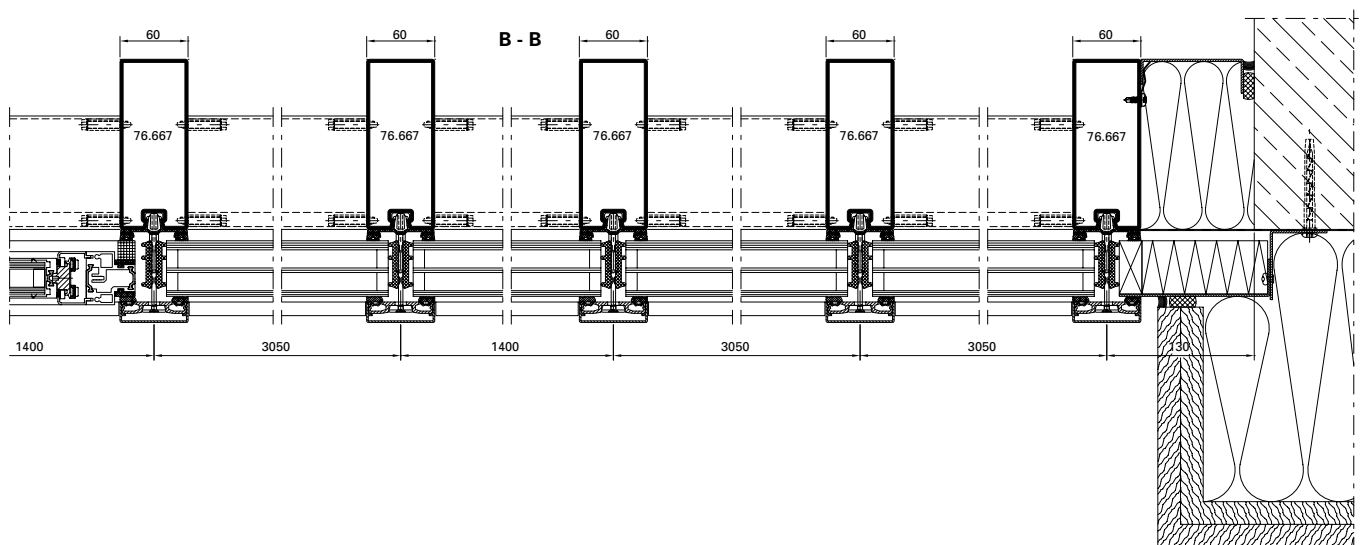

A - A

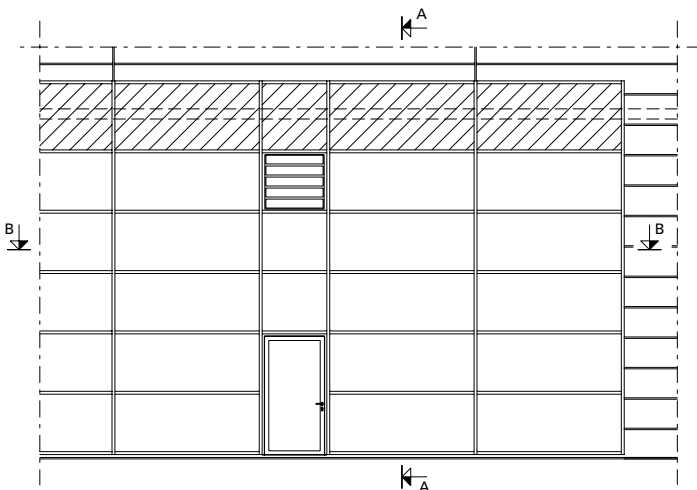
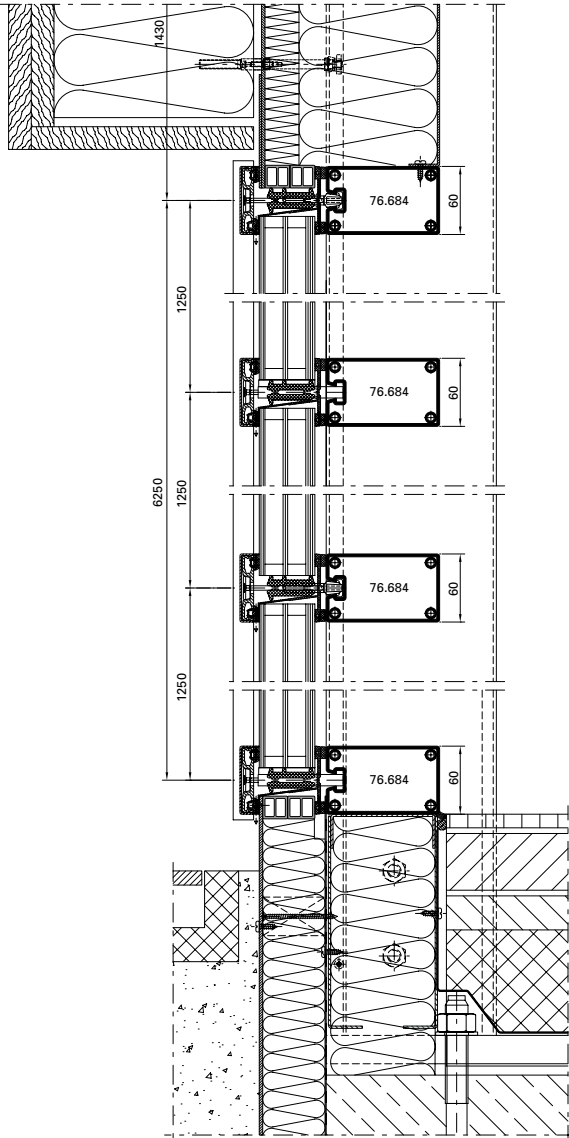

Ausgeführte Objekte

Objets réalisés

Completed projects

Objekt:

Musikkonservatorium, Bilbao/ES

System:

VISS TVS

Architekt:

Roberto Ercilla Arquitectura,
Vitoria/ES

Objet:

Conservatoire de musique, Bilbao/ES

Système:

VISS TVS

Architecte:

Roberto Ercilla Arquitectura,
Vitoria/ES

Project:

Conservatory of Music, Bilbao/ES

System:

VISS TVS

Architect:

Roberto Ercilla Arquitectura,
Vitoria/ES



Objekt:

Landesberufsschule, Mureck/AT

System:

VISS TVS Linea

Architekt:

Architekten Domenig & Wallner
ZT GmbH, Graz/AT

Objet:

École professionnelle, Mureck/AT

Système:

VISS TVS Linea

Architecte:

Architekten Domenig & Wallner
ZT GmbH, Graz/AT

Project:

State vocational school, Mureck/AT

System:

VISS TVS Linea

Architect:

Architekten Domenig & Wallner
ZT GmbH, Graz/AT



Ausgeführte Objekte
Objets réalisés
Completed projects



Fotos: Jochen Helle, Dortmund

Objekt:

Hafencity Schule, Hamburg/DE

System:

VISS Fire E30 TVS vertikal und schräg,
Janisol Türen

Architekt:

Spengler-Wiescholek Architekten,
Hamburg/DE

Objet:

École Hafencity, Hamburg/DE

Système:

VISS Fire E30 TVS vertical et oblique,
Portes Janisol

Architecte:

Spengler-Wiescholek Architekten,
Hamburg/DE

Project:

Hafencity school, Hamburg/DE

System:

VISS Fire E30 TVS vertical and sloping,
Janisol doors

Architect:

Spengler-Wiescholek Architekten,
Hamburg/DE



A - A

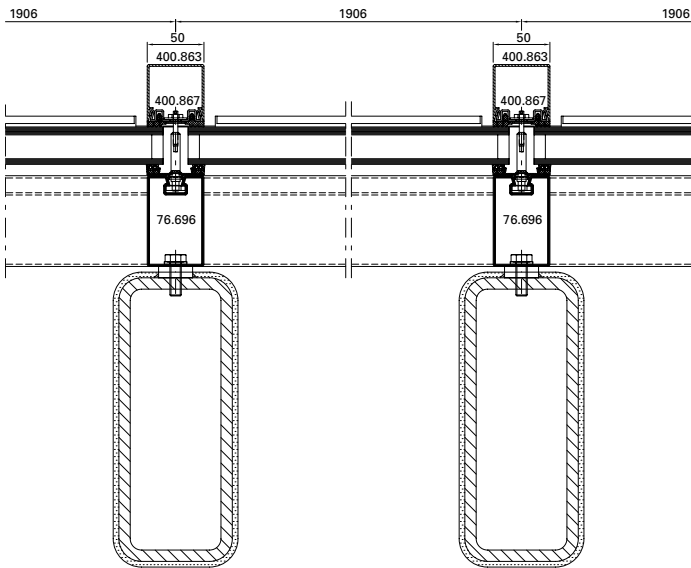

B

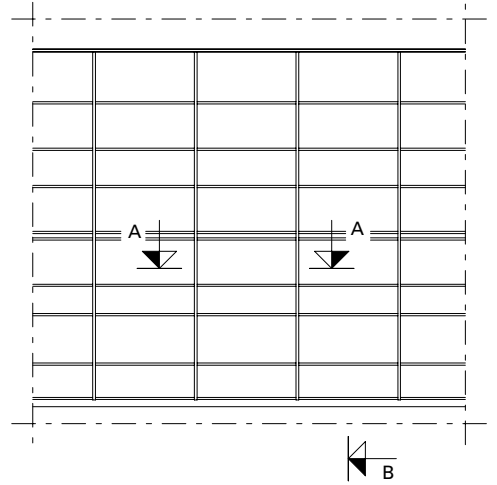

B - B

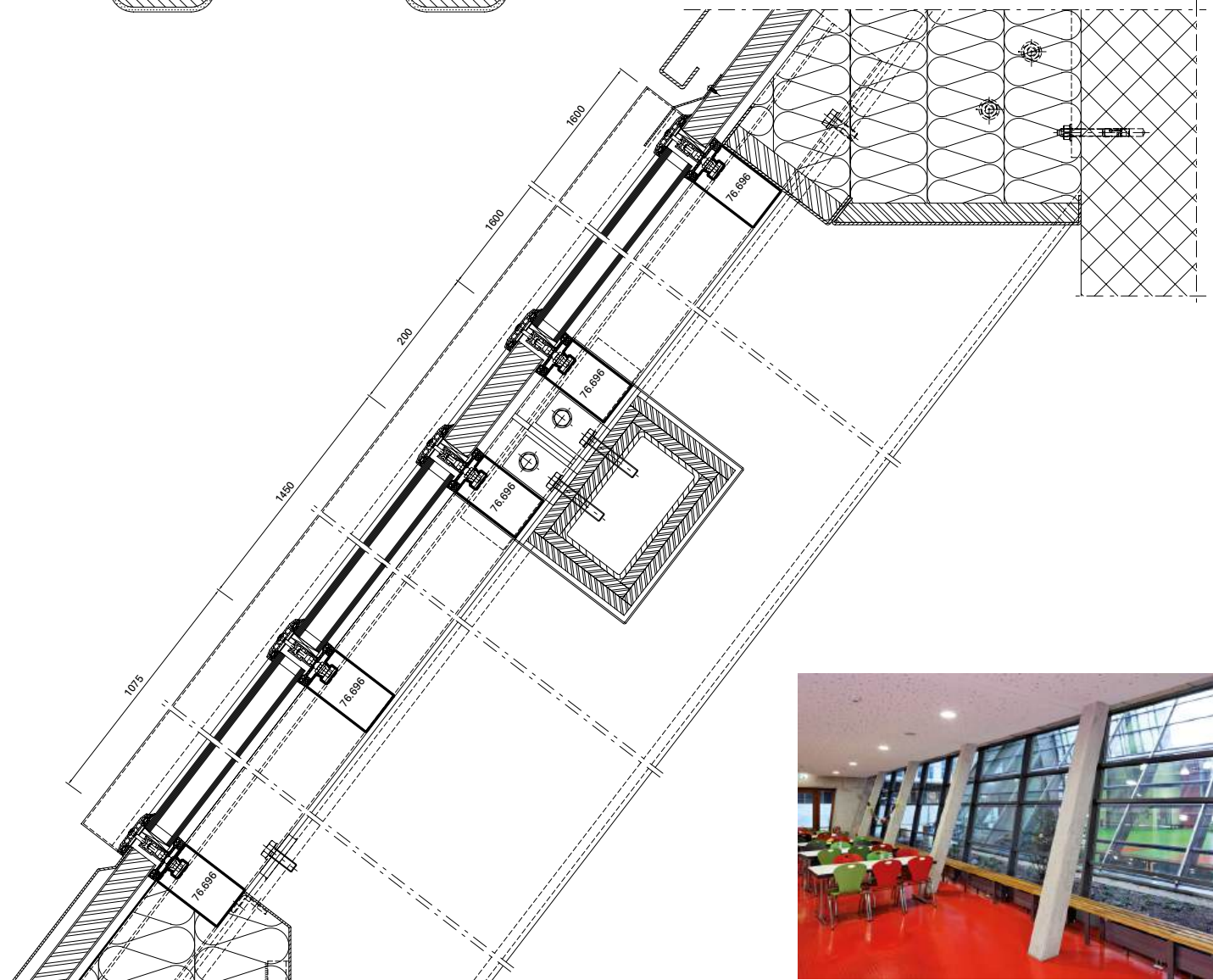

Ausgeführte Objekte

Objets réalisés

Completed projects

Objekt:

Drehrestaurant «Hoher Kasten»,
Brülisau/CH

System:

VISS Basic TVS

Architekt:

architekten : rlc ag, Rheineck/CH

Objet:

Restaurant panoramique
«Hoher Kasten», Brülisau/CH

Système:

VISS Basic TVS

Architecte:

architekten : rlc ag, Rheineck/CH

Project:

Revolving restaurant «Hoher Kasten»,
Brülisau/CH

System:

VISS Basic TVS

Architect:

architekten : rlc ag, Rheineck/CH

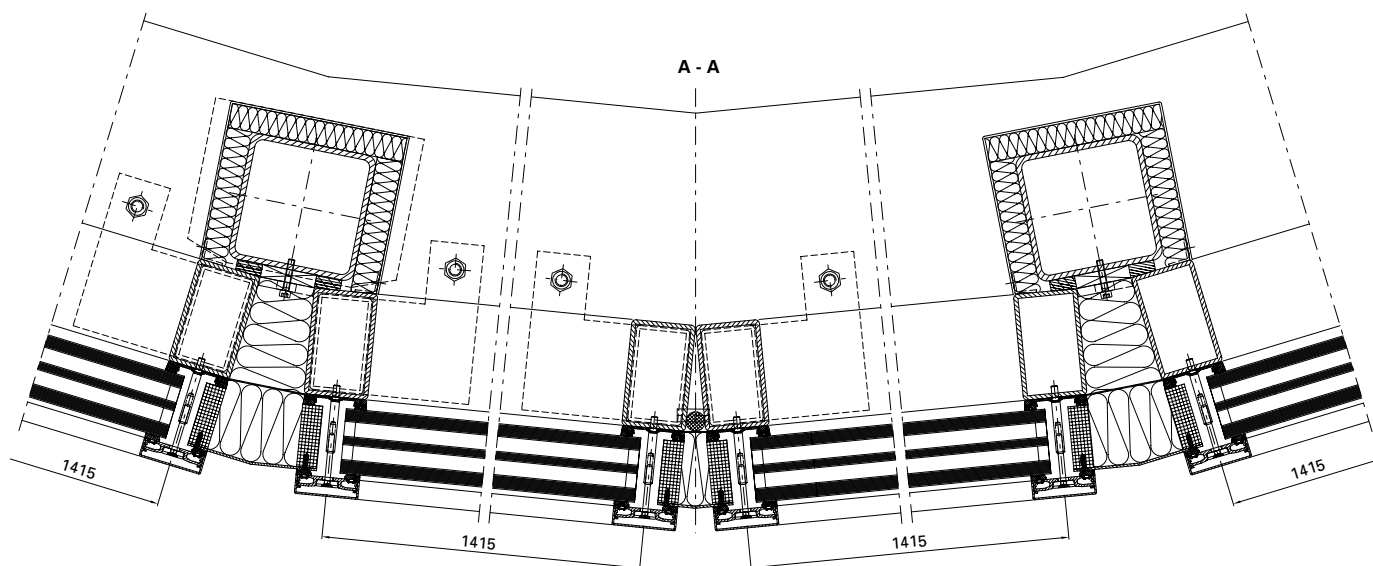

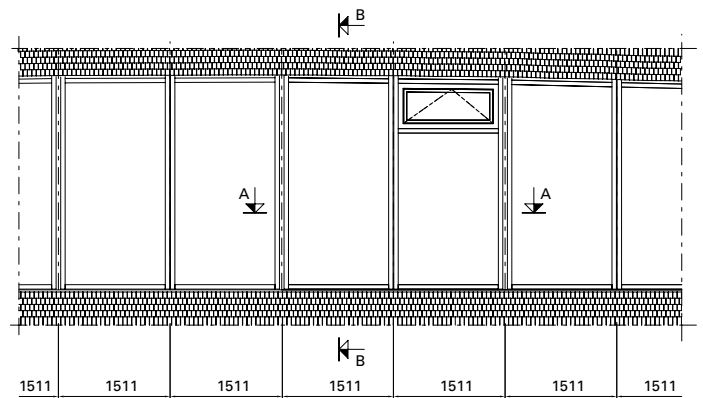
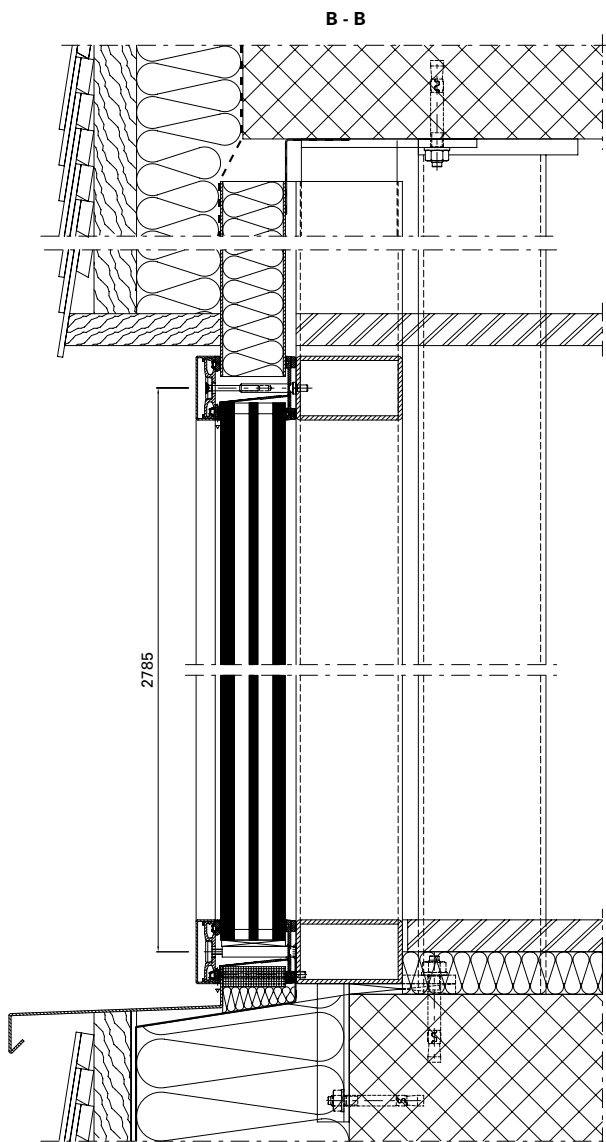

Ausgeführte Objekte

Objets réalisés

Completed projects

Objekt:

Hauptbahnhof «Rotterdam Centraal»,
Rotterdam/NL

System:

VISS Basic, VISS Fire, Janisol Türen

Architekt:

Team CS: Zusammenarbeit von
Bentham Crowel Architekten,
Meyer en Van Schooten Architecten
und West 8, Rotterdam/NL

Objet:

Gare centrale «Rotterdam Centraal»,
Rotterdam/NL

Système:

VISS Basic, VISS Fire, portes Janisol

Architecte:

Team CS: Coopération de Bentham
Crowel Architectes, Meyer en Van
Schooten Architectes et West 8,
Rotterdam/NL

Project:

Central station «Rotterdam Centraal»,
Rotterdam/NL

System:

VISS Basic, VISS Fire, Janisol doors

Architect:

Team CS: a cooperation of Bentham
Crowel Architects, Meyer en Van
Schooten Architects and West 8,
Rotterdam/NL

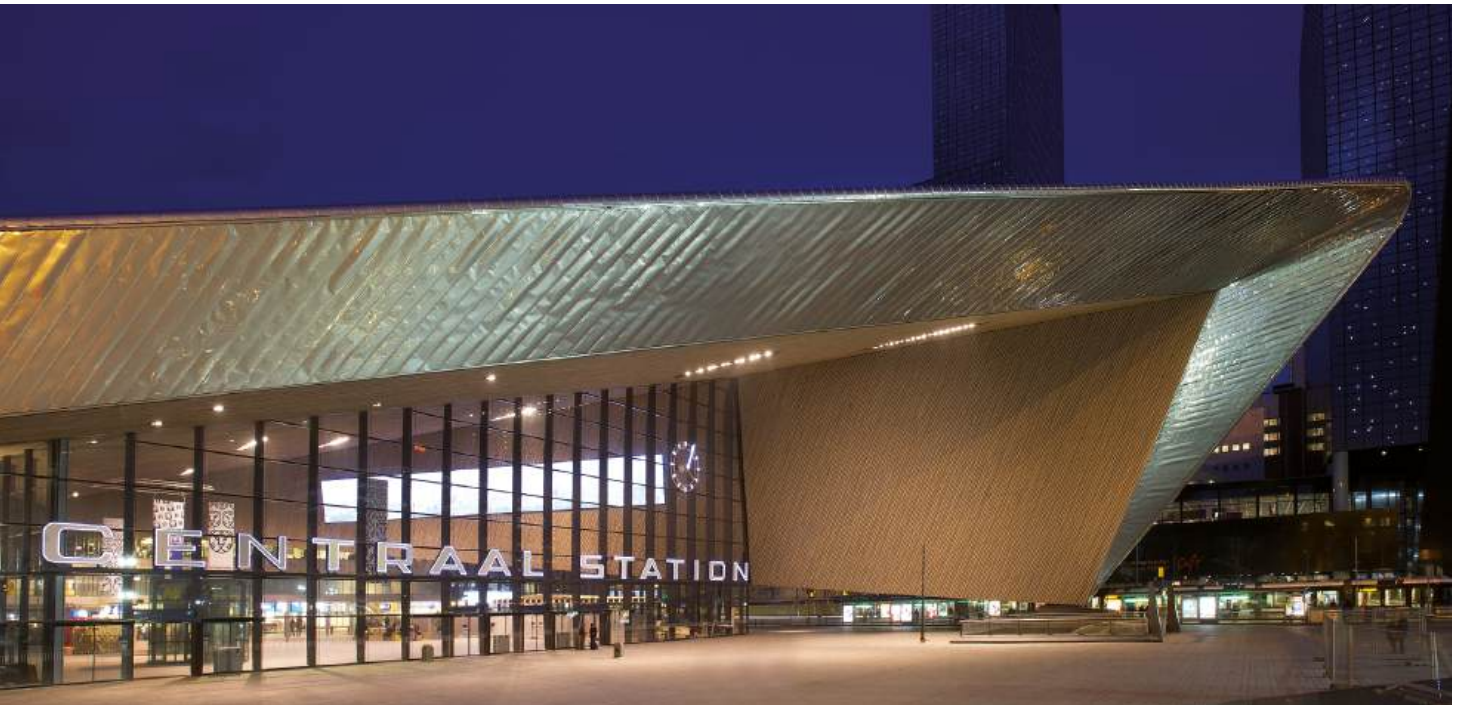



Ausgeführte Objekte

Objets réalisés

Completed projects

Objekt:

IGuzzini Illuminazione, Barcelona/ES

System:

VISS TVS, Janisol Fenster und Türen,
Jansen-Economy 50/60

Architekt:

Josep Mias, Mias Arquitectos ACTAR,
Barcelona/ES

Objet:

IGuzzini Illuminazione, Barcelone/ES

Système:

VISS TVS, Janisol portes et fenêtres,
Jansen-Economy 50/60

Architecte:

Josep Mias, Mias Arquitectos ACTAR,
Barcelone/ES

Project:

IGuzzini Illuminazione, Barcelona/ES

System:

VISS TVS, Janisol doors and windows,
Jansen-Economy 50/60

Architect:

Josep Mias, Mias Arquitectos ACTAR,
Barcelona/ES

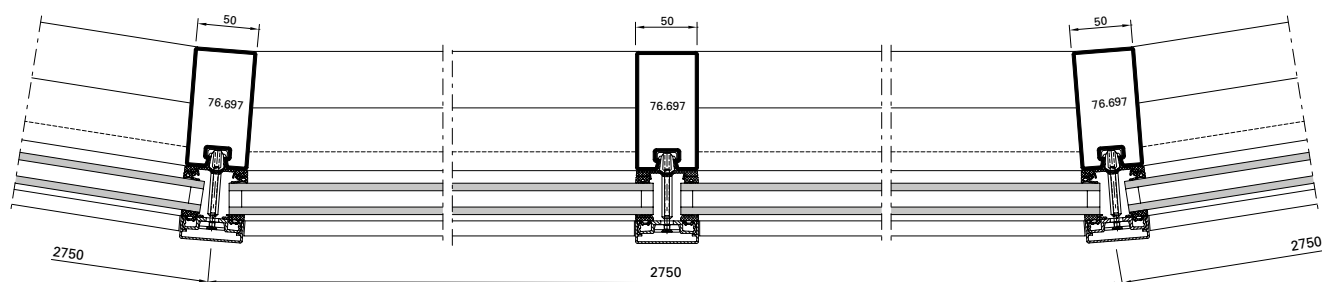

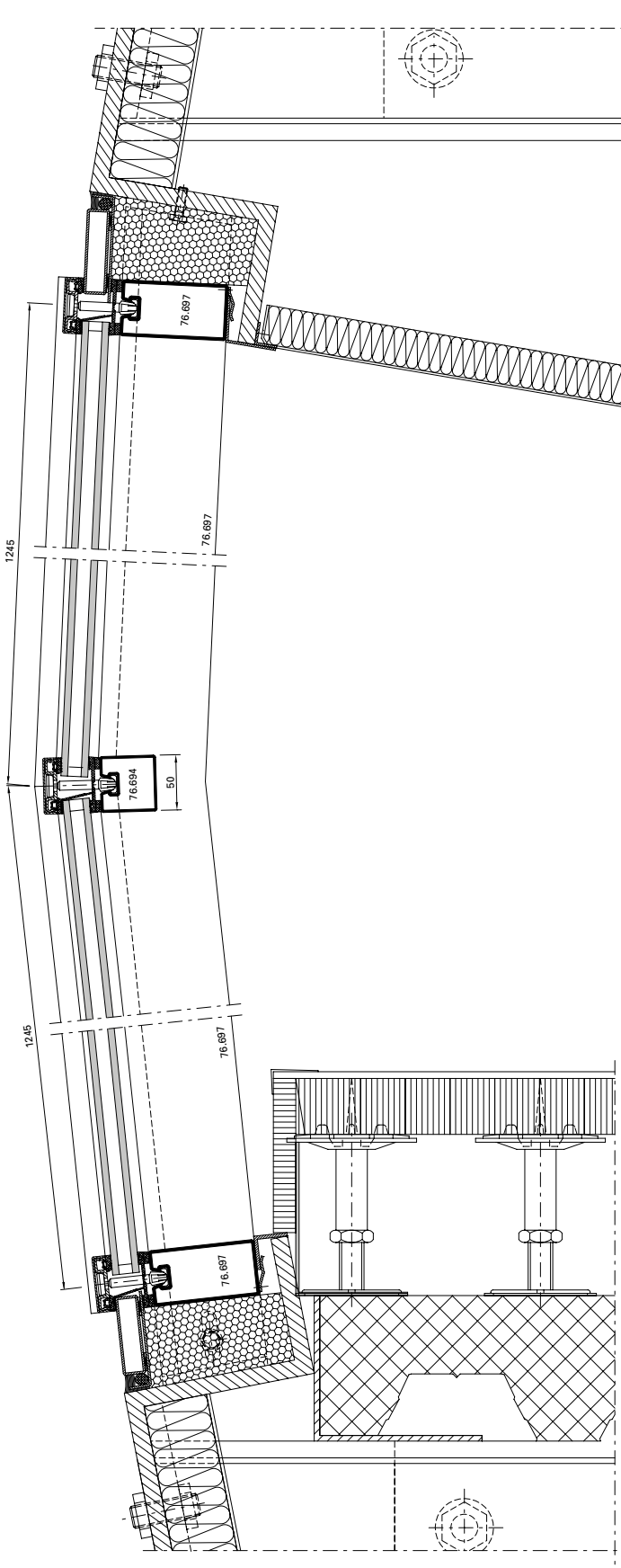

Ausgeführte Objekte

Objets réalisés

Completed projects

Objekt:

«Erasmus» Studenten-Pavillon,
Rotterdam/NL

System:

VISS I_xtra SG

Architekt:

Powerhouse Company &
DeZwarteHond, Rotterdam/NL

Objet:

Pavillon pour étudiants «Erasmus»,
Rotterdam/NL

Système:

VISS I_xtra SG

Architecte:

Powerhouse Company &
DeZwarteHond, Rotterdam/NL

Project:

«Erasmus» student pavilion,
Rotterdam/NL

System:

VISS I_xtra SG

Architect:

Powerhouse Company &
DeZwarteHond, Rotterdam/NL

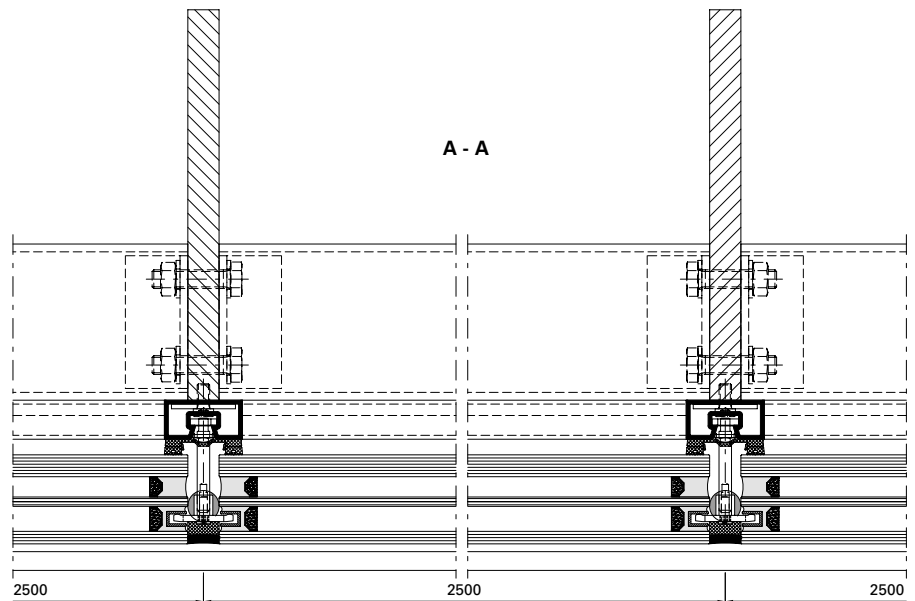

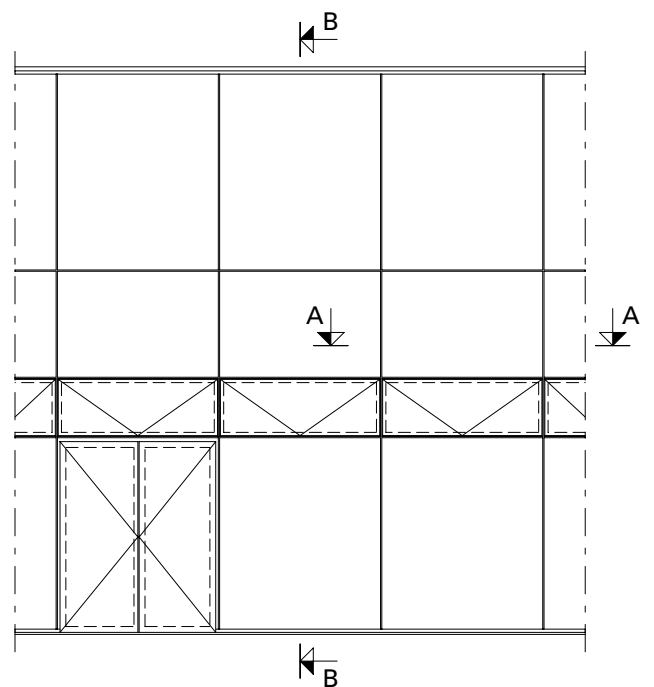
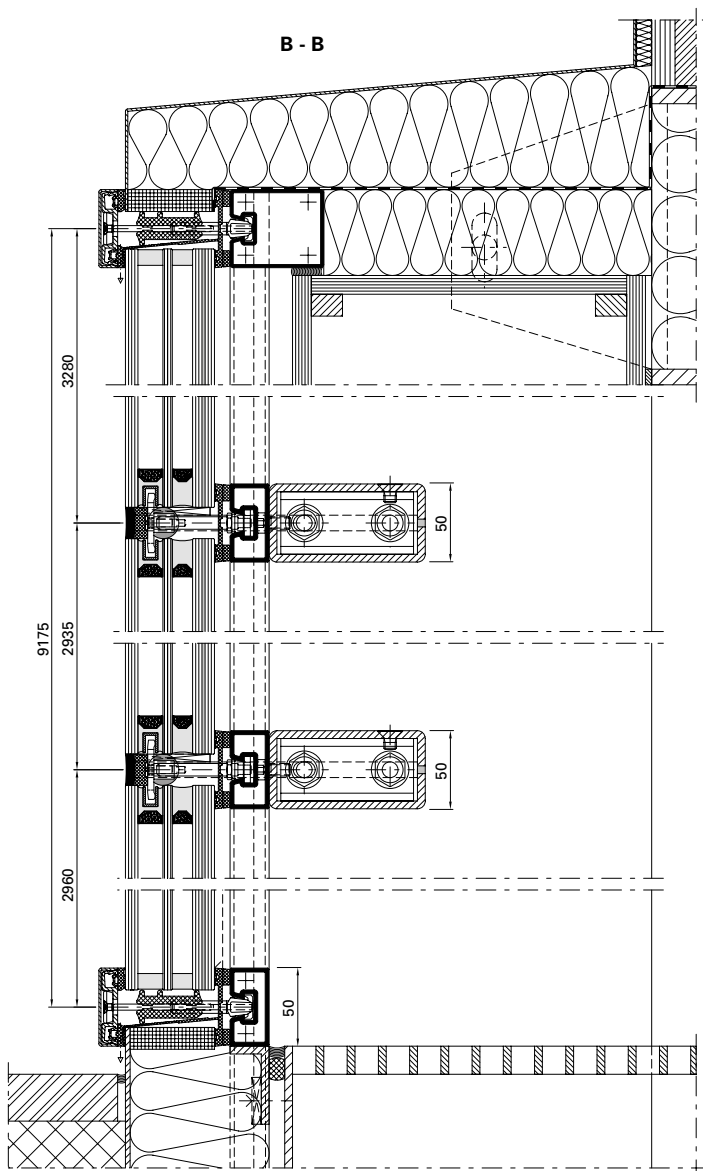

Ausgeführte Objekte
Objets réalisés
Completed projects



Fotos: Stephan Falk, Berlin

Objekt:

Hochschule «Anstalt für angewandte Wissenschaften», Dessau/DE

System:

VISS TVS

Architekt:

Kossel, Simon und Partner,
Magdeburg/DE

Objet:

École supérieure «Anstalt für angewandte Wissenschaften», Dessau/DE

Système:

VISS TVS

Architecte:

Kossel, Simon und Partner,
Magdeburg/DE

Project:

University «Anstalt für angewandte Wissenschaften», Dessau/DE

System:

VISS TVS

Architect:

Kossel, Simon und Partner,
Magdeburg/DE



Objekt:

Justizgebäude, Würzburg/DE

System:

VISS TVS, VISS Fire TVS (schräg)

Architekt:

Staatliches Bauamt Würzburg, Abt. L4, Würzburg/DE

Objet:

Palais de justice, Würzburg/DE

Système:

VISS TVS, VISS Fire TVS (oblique)

Architecte:

Staatliches Bauamt Würzburg, Abt. L4, Würzburg/DE

Project:

Law courts, Würzburg/DE

System:

VISS TVS, VISS Fire TVS (sloping)

Architect:

Staatliches Bauamt Würzburg, Abt. L4, Würzburg/DE



Fotos: Gerhard Hagen, Bamberg

Ausgeführte Objekte

Objets réalisés

Completed projects

Objekt:

Halle M, Jansen AG, Oberriet/CH

System:

VISS TVS HI

Architekt:

Göldi + Eggenberger AG,
Altstätten/CH

Objet:

Hall M, Jansen AG, Oberriet/CH

Système:

VISS TVS HI

Architecte:

Göldi + Eggenberger AG,
Altstätten/CH

Project:

Hall M, Jansen AG, Oberriet/CH

System:

VISS TVS HI

Architect:

Göldi + Eggenberger AG,
Altstätten/CH



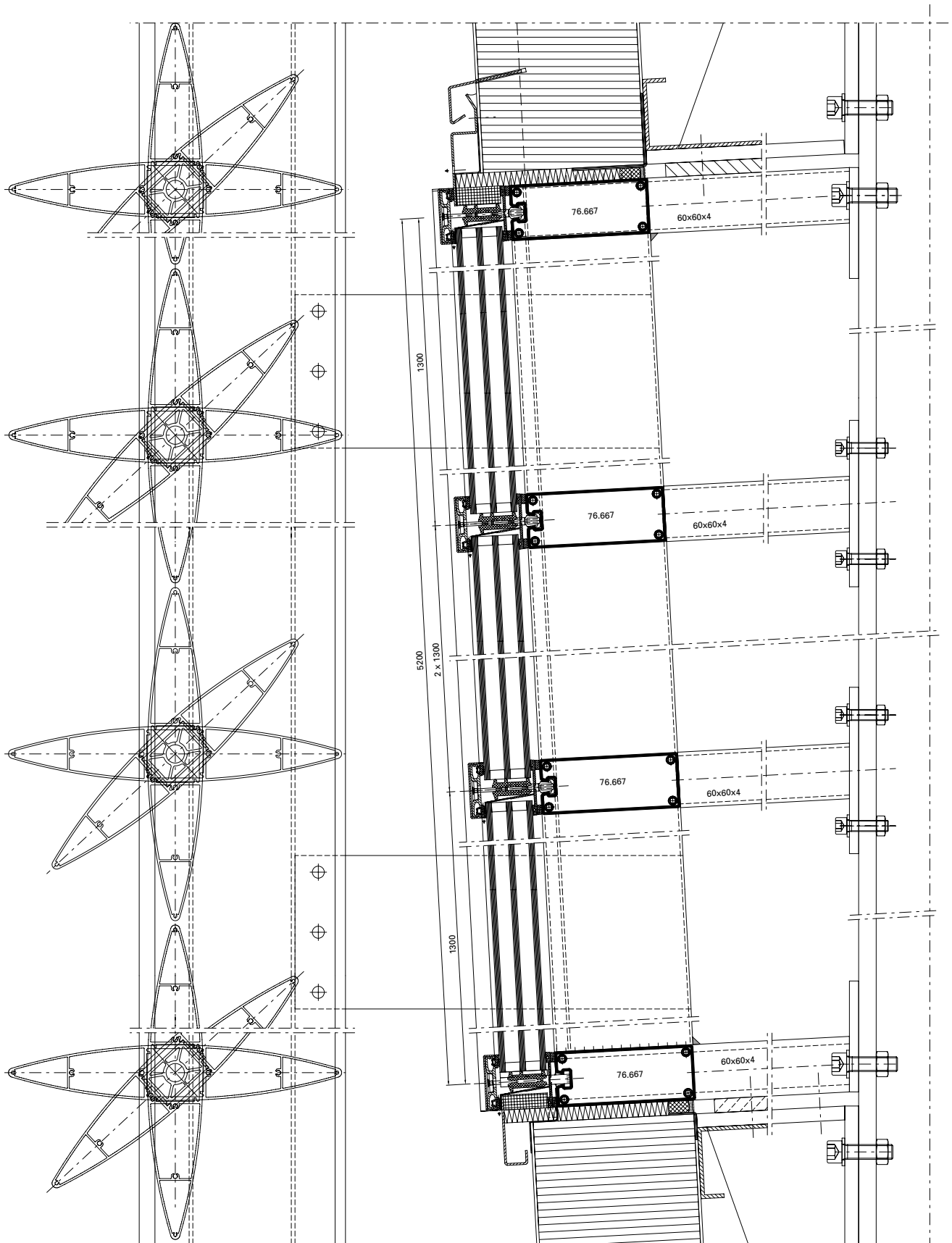

Ausgeführte Objekte
Objets réalisés
Completed projects



Fotos: Stephan Falk, Berlin

Objekt:

Vogtlandhalle (Stadthalle), Greiz/DE

System:

VISS TVS, Janisol Falte wand

Architekt:

Hoffmann.Seifert.Partner mit Ernst Scharf, Erfurt/DE

Objet:

Vogtlandhalle (salle municipale), Greiz/DE

Système:

VISS TVS, Janisol porte repliable

Architecte:

Hoffmann.Seifert.Partner mit Ernst Scharf, Erfurt/DE

Project:

Vogtland hall (city hall), Greiz/DE

System:

VISS TVS, Janisol folding wall

Architect:

Hoffmann.Seifert.Partner mit Ernst Scharf, Erfurt/DE

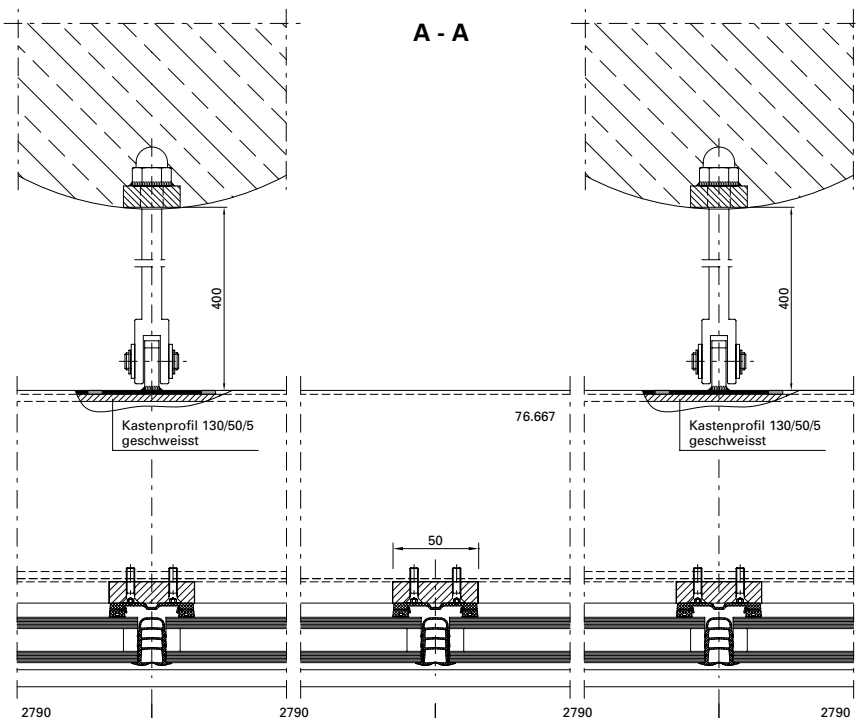

B - B

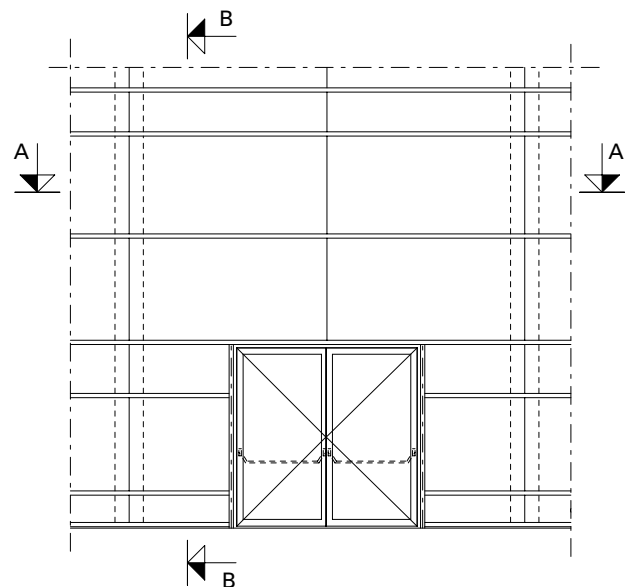
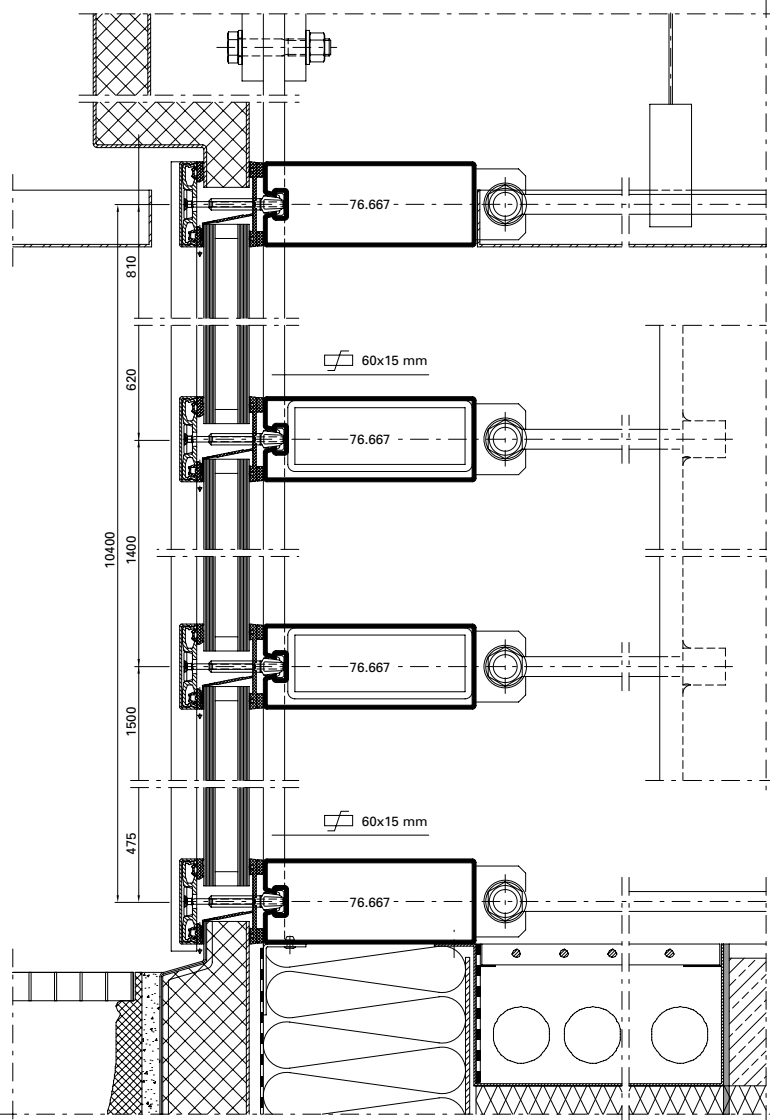

Ausgeführte Objekte Objets réalisés Completed projects

Objekt:

Ausbau Messehalle BEA Expo,
Bern/CH

System:

VISS Fire E30/EI30,
Jansen-Economy E30, Janisol 2 EI30

Architekt:

Schwaar & Partner AG, Bern/CH

Objet:

Agrandissement du hall d'exposition
BEA Expo, Berne/CH

Système:

VISS Fire E30/EI30,
Jansen-Economy E30, Janisol 2 EI30

Architecte:

Schwaar & Partner AG, Berne/CH

Project:

Exhibition hall extension BEA Expo,
Bern/CH

System:

VISS Fire E30/EI30,
Jansen-Economy E30, Janisol 2 EI30

Architect:

Schwaar & Partner AG, Bern/CH



Objekt:

MAN Nutzfahrzeuge, Werkserweiterung,
München/DE

System:

VISS I_xtra, Janisol Türen

Architekt:

DMP Architekten BDA, München/DE

Objet:

MAN Nutzfahrzeuge, agrandissement
de l'usine, Munich/DE

Système:

VISS I_xtra, portes Janisol

Architecte:

DMP Architekten BDA, Munich/DE

Project:

MAN Nutzfahrzeuge, plant extension,
Munich/DE

System:

VISS I_xtra, Janisol doors

Architect:

DMP Architekten BDA, Munich/DE



Ausgeführte Objekte Objets réalisés Completed projects

Objekt:

Museumsquartier, Den Bosch/NL

System:

VISS I_xtra TV

Architekt:

Bierman Henket Architecten, Esch/NL

Objet:

Quartier des musées, Den Bosch/NL

Système:

VISS I_xtra TV

Architecte:

Bierman Henket Architecten, Esch/NL

Project:

Museum Quarter, Den Bosch/NL

System:

VISS I_xtra TV

Architect:

Bierman Henket Architecten, Esch/NL

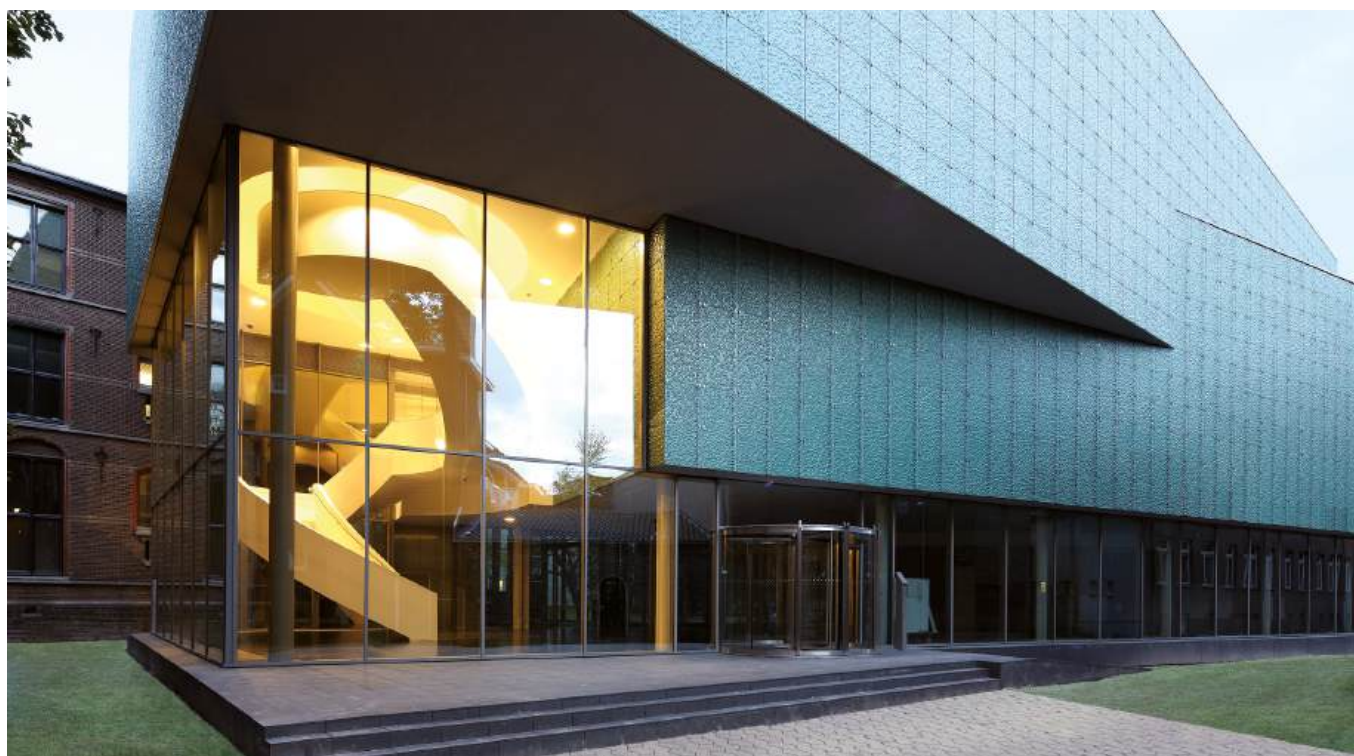

B - B

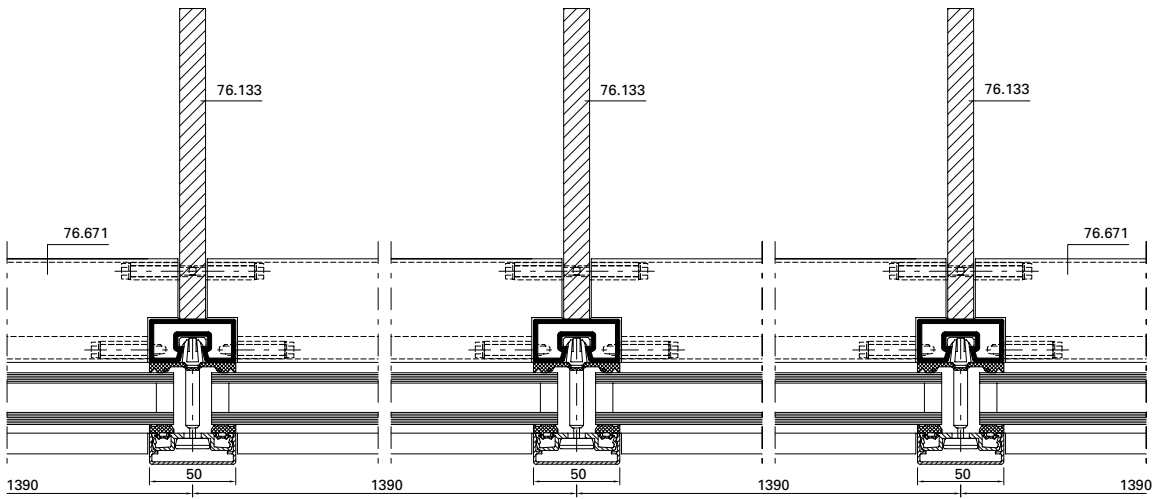

A - A

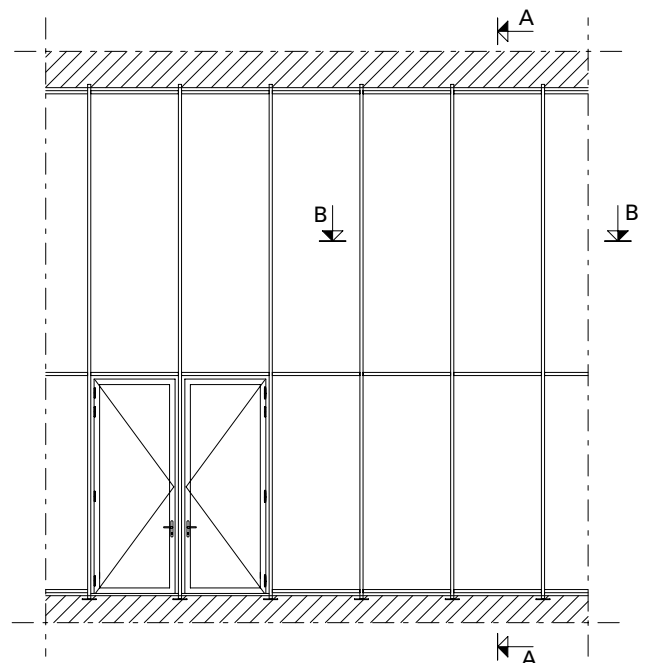
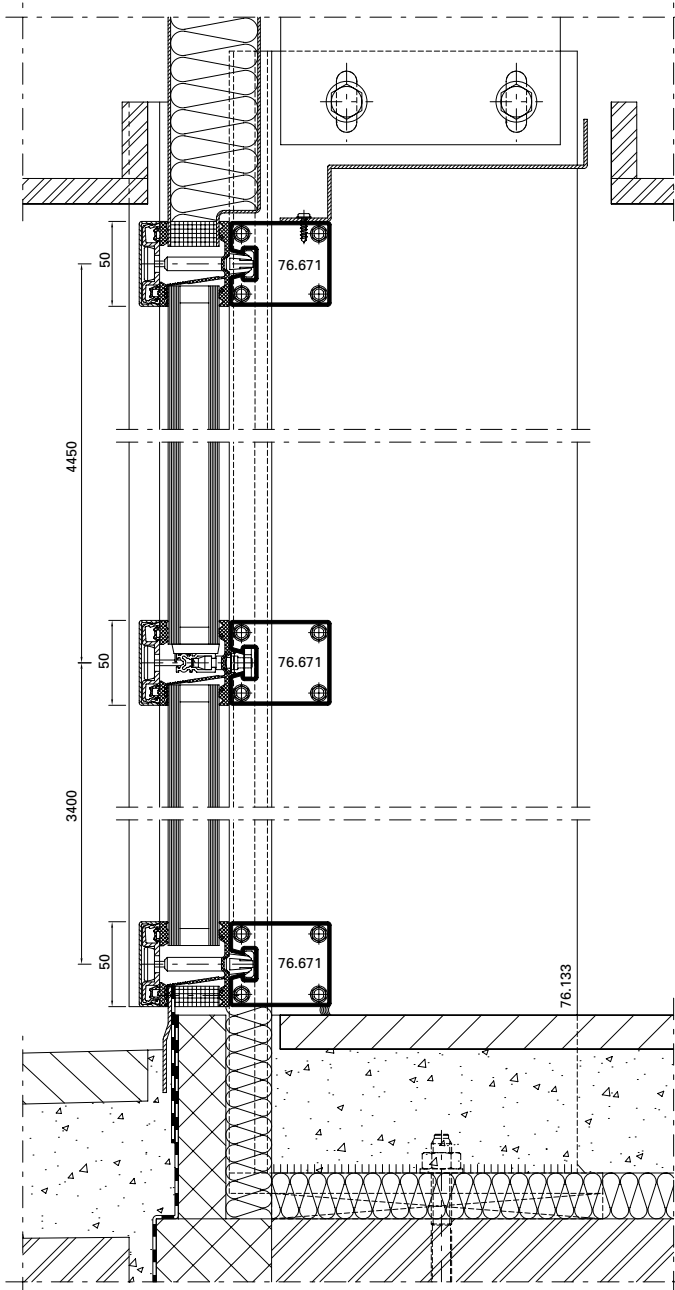

Ausgeführte Objekte Objets réalisés Completed projects

Objekt:

Werkhalle Glas Trösch,
St.Gallen/CH

System:

VISS TVS

Architekt:

Schuchter Ehle, Architekten, St.Gallen/
CH

Objet:

Atelier de Glas Trösch,
Saint-Gall/CH

Système:

VISS TVS

Architecte:

Schuchter Ehle, Architekten,
Saint-Gall/CH

Project:

Glas Trösch factory building,
St. Gallen/CH

System:

VISS TVS

Architect:

Schuchter Ehle, Architekten, St.Gallen/
CH





Objekt:

Voentorg Center,
Moskau/RU

System:

VISS TV, VISS Fire

Architekt:

Mosprojekt-2: Kolosnitsin Vladimir
Vasilyevich / Starikov Alexander
Fedorovich, Moskau/RU

Objet:

Centre Voentorg,
Moscou/RU

Système:

VISS TV, VISS Fire

Architecte:

Mosprojekt-2: Kolosnitsin Vladimir
Vasilyevich / Starikov Alexander
Fedorovich, Moscou/RU

Project:

Voentorg Center,
Moscow/RU

System:

VISS TV, VISS Fire

Architect:

Mosprojekt-2: Kolosnitsin Vladimir
Vasilyevich / Starikov Alexander
Fedorovich, Moscow/RU



Ausgeführte Objekte Objets réalisés Completed projects

Objekt:

Neue Messehalle
(Kielce Trade Fairs), Kielce/PL

System:

VISS TVS (vertikal und schräg),
Janisol 2 E130, Falttore

Architekt:

bsp Architekten: Barbara Średniawa,
Gliwice/PL

Objet:

Nouveau hall d'exposition
(Kielce Trade Fairs), Kielce/PL

Système:

VISS TVS (vertical et oblique),
Janisol 2 E130, Porte accordéon

Architecte:

bsp Architekten: Barbara Średniawa,
Gliwice/PL

Project:

New exhibition hall
(Kielce Trade Fairs), Kielce/PL

System:

VISS TVS (vertical and sloping),
Janisol 2 E130, Folding doors

Architect:

bsp Architekten: Barbara Średniawa,
Gliwice/PL



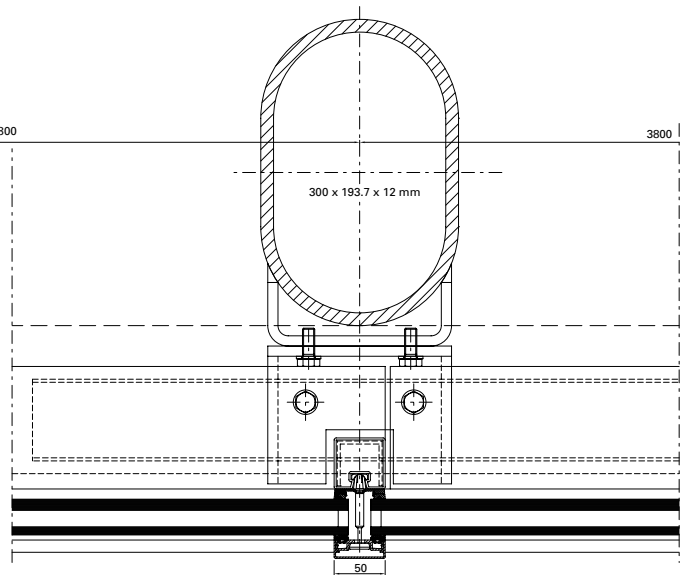
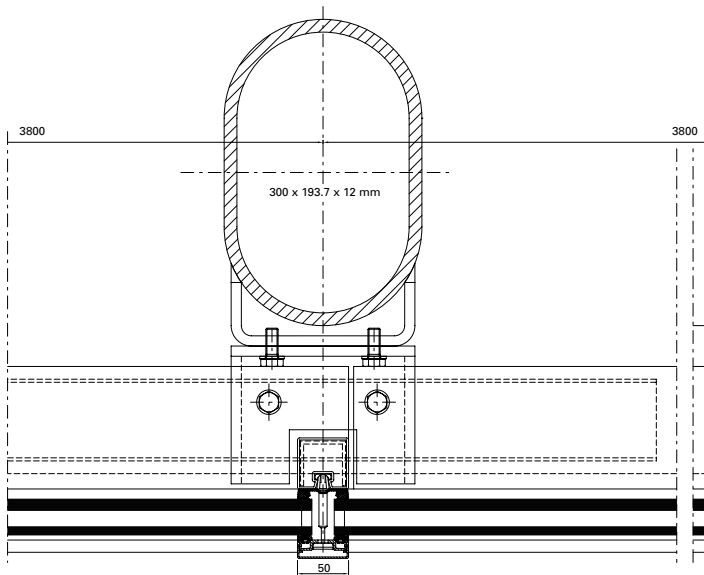
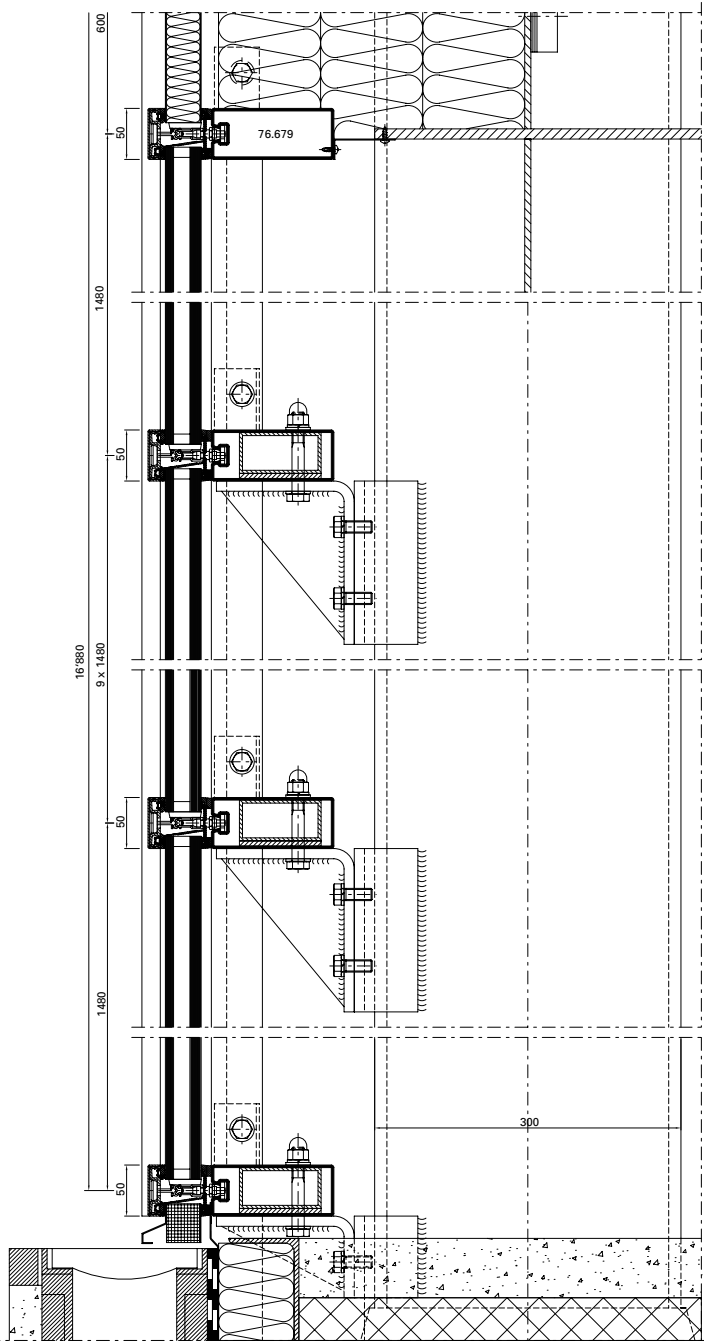



3 Wissenschafts-
zentrum Kopernikus,
Warschau/PL



4 Schloss Novy Svetlov,
Bojkovice/CZ



5 Hotel Magyar Király,
Székesfehérvár/HU



6 Theater- und
Konzerthaus Kilden,
Kristiansand/NO



8 Museum für
moderne Kunst,
Zagreb/HR



10 Museum für Kunst
und Kulturgeschichte
Altona,
Hamburg-Altona/DE



11 TransPort
(Flughafen Schiphol),
Amsterdam/NL



12 Büro- und
Geschäftshaus
«Hillsite»,
Schwalbach am
Taunus/DE



14 Zentralarchiv EDF,
Bure/FR



16 Gemeindehaus,
Ruidellots de la
Selva/ES



17 Hauptbahnhof,
Köln/DE



18 Universität
Lausanne
«Géopolis»,
Lausanne/CH



20 Jansen AG, Campus,
Oberriet/CH



22 Bildungsforum,
Potsdam/DE



24 Besucherzentrum
«Alte Wasserzentrale»,
Pietra Neamt/RO



26 Hotel Novi Spa,
Novi Vinodolski/HR



27 Solvias AG, Büro-
und Lagergebäude,
Kaiseraugst/CH



28 Médiathèque,
Pau/FR



30 «Mumuth» Haus
für Musik &
Musiktheater der
Kunstuniversität,
Graz/AT



32 Centre Pompidou,
Metz/FR



33 Alters- und
Pflegeheim,
Burgdorf/CH



34 Drents Museum,
Assen/NL



36 Akustik-Tunnels,
Warschau/PL



38 Jin Ji Hu
Kempinski Hotel,
Suzhou/CN



39 Historisches
Museum,
Kharkov/UA



40 Kunstgebäude,
Stuttgart/DE



42 3-Feldsporthalle,
Ingelfingen/DE



44 Musikonservatorium,
Bilbao/ES



45 Landesberufsschule,
Mureck/AT



46 Hafencity Schule,
Hamburg/DE



48 Drehrestaurant
«Hoher Kasten»,
Brülisau/CH



50 Hauptbahnhof
«Rotterdam Centraal»,
Rotterdam/NL



52 IGuzzini
Illuminazione,
Barcelona/ES



54 «Erasmus»
Studenten-Pavillon,
Rotterdam/NL



56 Hochschule
«Anstalt für
angewandte
Wissenschaften»,
Dessau/DE



57 Justizgebäude,
Würzburg/DE



58 Halle M, Jansen AG,
Oberriet/CH



60 Vogtlandhalle
(Stadthalle),
Greiz/DE



62 Ausbau Messehalle
BEA Expo,
Bern/CH



63 MAN Nutzfahrzeuge,
Werkserweiterung,
München/DE



64 Museumsquartier,
Den Bosch/NL



66 Werkhalle
Glas Trösch,
St.Gallen/CH



67 Voentorg Center,
Moskau/R



68 Neue Messehalle
(Kielce Trade Fairs),
Kielce/PL

Ausgeführte Objekte
Objets réalisés
Completed projects

Objekt:

Wissenschaftszentrum Kopernikus,
Centrum Nauki Kopernik, Warschau/PL

System:

VISS TVS, VISS SG, VISS Fire,
Janisol 2 EI30, Janisol SG

Architekt:

RAR-2 Laboratorium Architektury
Jan Kubec, Ruda Śląska/PL

Objet:

Centre de recherche Copernique,
Centrum Nauki Kopernik, Varsovie/PL

Système:

VISS TVS, VISS SG, VISS Fire,
Janisol 2 EI30, Janisol SG

Architecte:

RAR-2 Laboratorium Architektury
Jan Kubec, Ruda Śląska/PL

Project:

Copernicus Science Centre,
Centrum Nauki Kopernik, Warsaw/PL

System:

VISS TVS, VISS SG, VISS Fire,
Janisol 2 EI30, Janisol SG

Architect:

RAR-2 Laboratorium Architektury
Jan Kubec, Ruda Śląska/PL

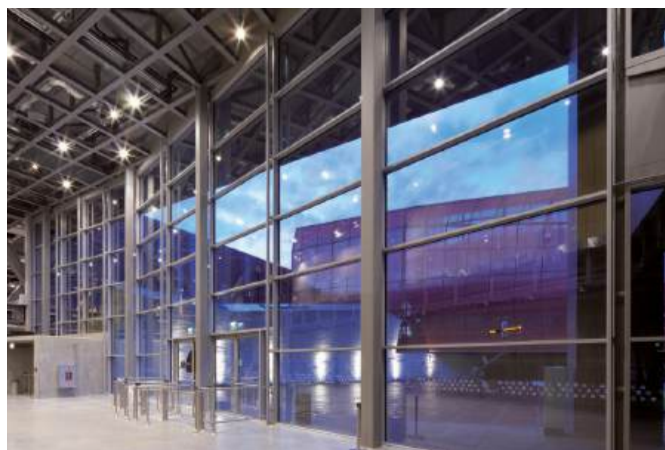

Ausgeführte Objekte
Objets réalisés
Completed projects



Objekt:

Schloss Novy Svetlov, Bojkovice/CZ

System:

VISS SG, VISS TVS (schräg)

Architekt:

Stavos s.r.o., Příbram/CZ

Objet:

Château Novy Svetlov, Bojkovice/CZ

Système:

VISS SG, VISS TVS (oblique)

Architecte:

Stavos s.r.o., Příbram/CZ

Project:

Novy Svetlov castle, Bojkovice/CZ

System:

VISS SG, VISS TVS (sloping)

Architect:

Stavos s.r.o., Příbram/CZ



Objekt:

Hotel Magyar Király,
Székesfehérvár/HU

System:

VISS TVS (schräg)

Architekt:

Szendro Epitesz Studio, Budapest/HU

Objet:

Hôtel Magyar Király,
Székesfehérvár/HU

Système:

VISS TVS (oblique)

Architecte:

Szendro Epitesz Studio, Budapest/HU

Project:

Hotel Magyar Király, Székesfehérvár/
HU

System:

VISS TVS (sloping)

Architect:

Szendro Epitesz Studio, Budapest/HU



Ausgeführte Objekte

Objets réalisés

Completed projects

Objekt:

Theater- und Konzerthaus Kilden,
Kristiansand/NO

System:

VISS I_xtra

Architekt:

ALA Architects, Helsinki/SF

Objet:

Maison du théâtre et des concerts
Kilden, Kristiansand/NO

Système:

VISS I_xtra

Architecte:

ALA Architects, Helsinki/SF

Project:

Kilden Performing Arts Centre,
Kristiansand/NO

System:

VISS I_xtra

Architect:

ALA Architects, Helsinki/SF



Fotos: Jiri Havran, Oslo

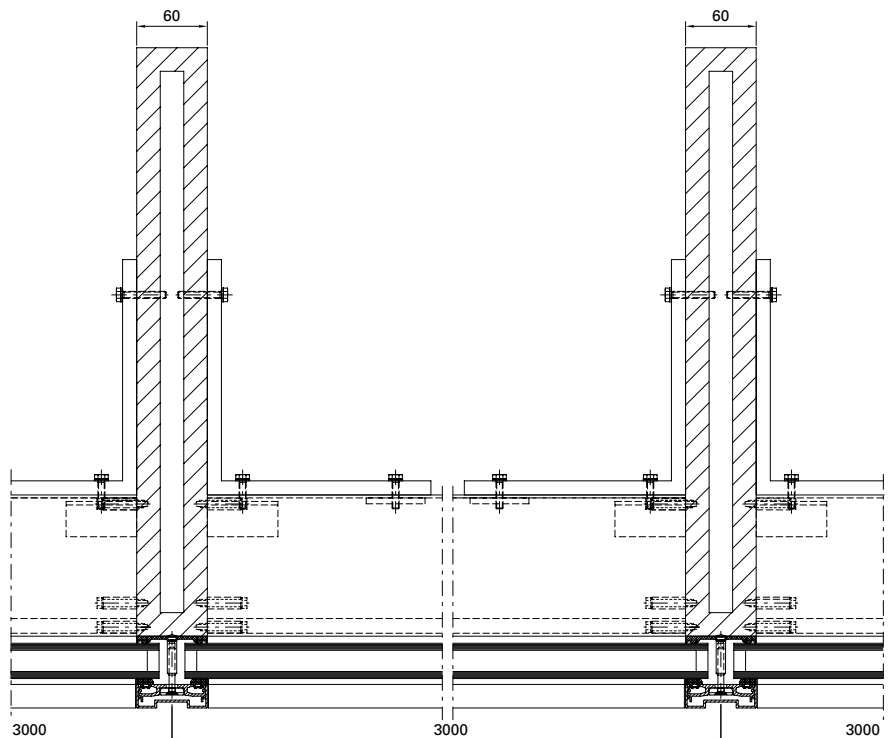
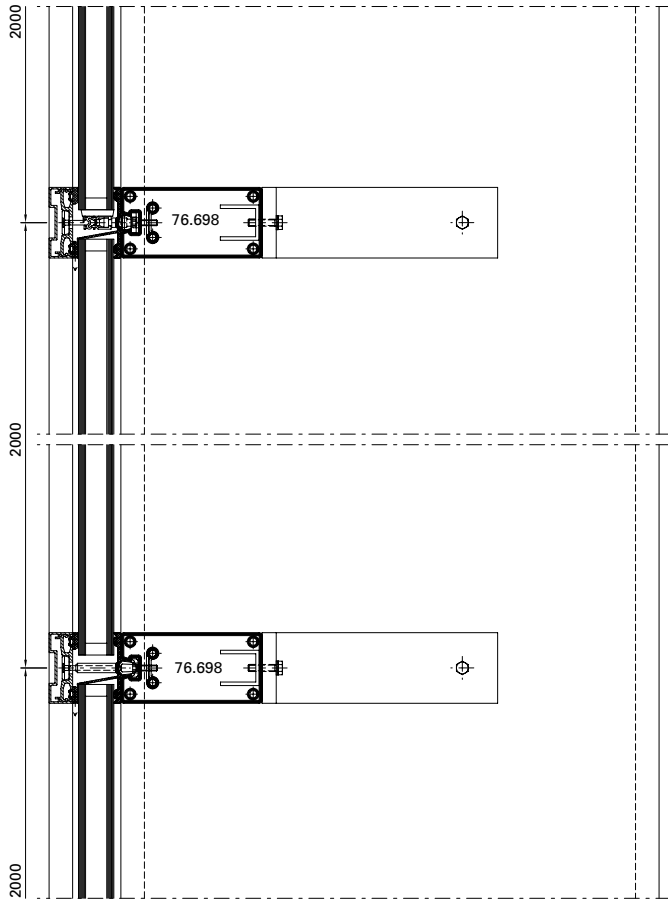

Ausgeführte Objekte

Objets réalisés

Completed projects

Objekt:

Museum für moderne Kunst, Zagreb/
HR

System:

VISS SG

Architekt:

Igor Franić Architekturstudio SZA,
Zagreb/HR

Objet:

Musée de l'art contemporain,
Zagreb/HR

Système:

VISS SG

Architecte:

Igor Franić Architekturstudio SZA,
Zagreb/HR

Project:

Museum of Contemporary Art, Zagreb/
HR

System:

VISS SG

Architect:

Igor Franić Architekturstudio SZA,
Zagreb/HR





Ausgeführte Objekte
Objets réalisés
Completed projects



Objekt:

Museum für Kunst und Kulturgeschichte Altona, Hamburg-Altona/DE

System:

VISS I_xtra, Janisol 2 EI30

Architekt:

Störmer Murphy and Partners GbR, Hamburg/DE

Objet:

Musée de l'art et de l'histoire de la civilisation Altona, Hambourg-Altona/DE

Système:

VISS I_xtra, Janisol 2 EI30

Architecte:

Störmer Murphy and Partners GbR, Hambourg/DE

Project:

Altona Museum of Art and Cultural History Altona, Hamburg-Altona/DE

System:

VISS I_xtra, Janisol 2 EI30

Architect:

Störmer Murphy and Partners GbR, Hamburg/DE



Fotos: Jochen Helle, Dortmund

Objekt:

TransPort (Flughafen Schiphol),
Amsterdam/NL

System:

VISS Basic TVS Fire, VISS TVS

Architekt:

Architectenbureau Paul de Ruiter,
Amsterdam/NL

Objet:

TransPort (aéroport Schiphol),
Amsterdam/NL

Système:

VISS Basic TVS Fire, VISS TVS

Architecte:

Architectenbureau Paul de Ruiter,
Amsterdam/NL

Project:

TransPort (Schiphol airport),
Amsterdam/NL

System:

VISS Basic TVS Fire, VISS TVS

Architect:

Architectenbureau Paul de Ruiter,
Amsterdam/NL



Fotos. Pieter Kers/NL

Ausgeführte Objekte

Objets réalisés

Completed projects

Objekt:

Büro- und Geschäftshaus «Hillsite»,
Schwalbach am Taunus/DE

System:

VISS Semi SG

Architekt:

Meixner-Schlüter-Wendt Architekten,
Frankfurt am Main/DE

Objet:

Immeuble de bureaux et de commerce
«Hillsite», Schwalbach am Taunus/DE

Système:

VISS Semi SG

Architecte:

Meixner-Schlüter-Wendt Architekten,
Frankfurt am Main/DE

Project:

«Hillsite» office complex,
Schwalbach am Taunus/DE

System:

VISS Semi SG

Architect:

Meixner-Schlüter-Wendt Architekten,
Frankfurt am Main/DE

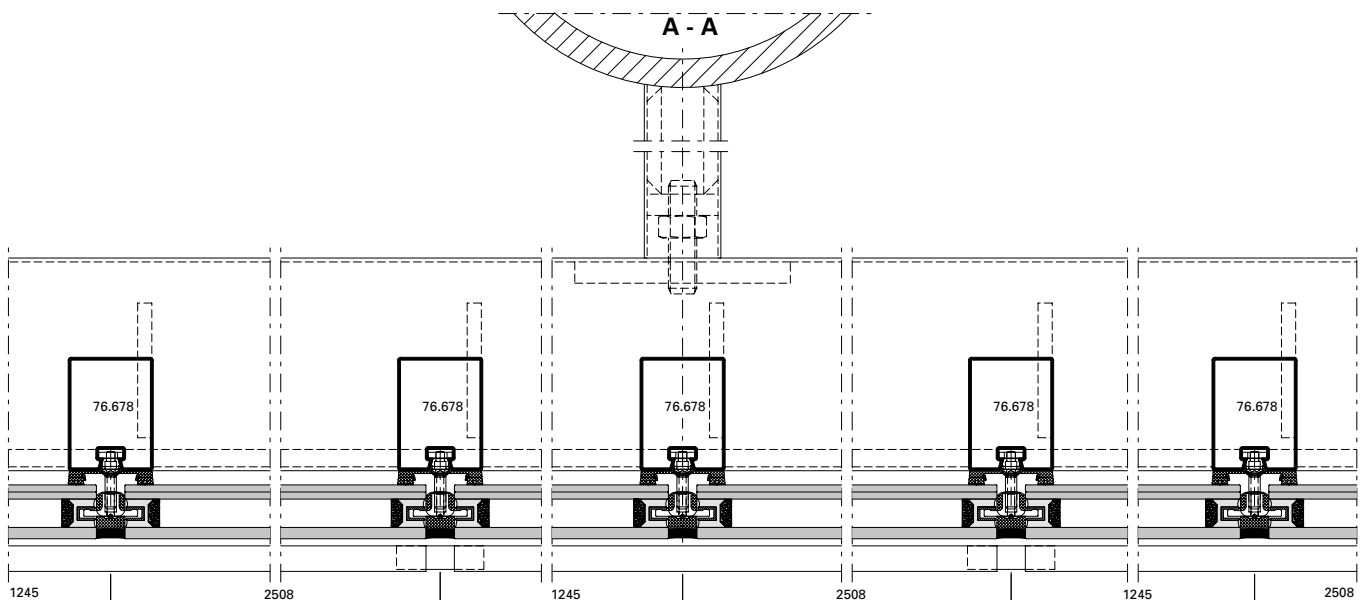

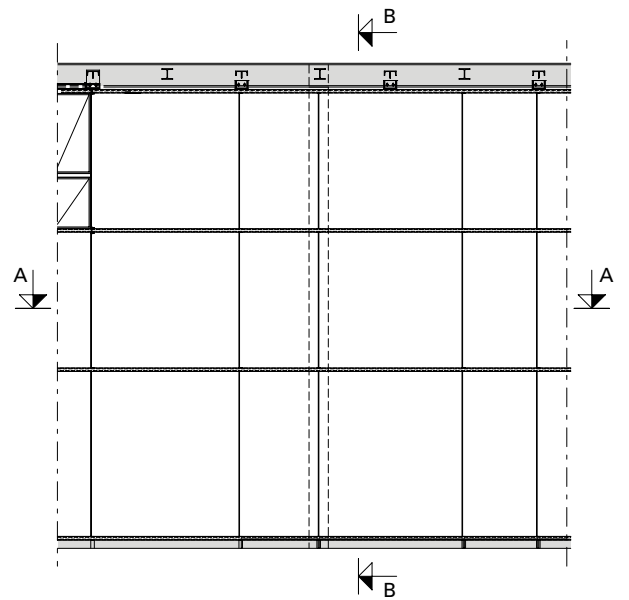
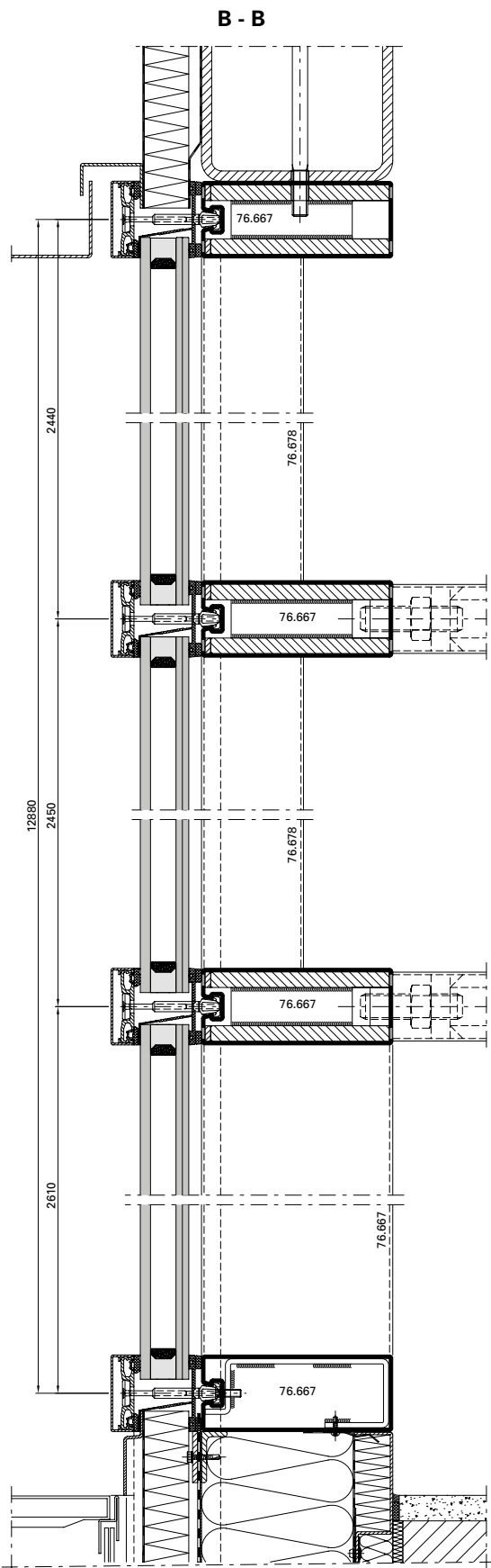

Ausgeführte Objekte Objets réalisés Completed projects

Objekt:

Zentralarchiv EDF, Bure/FR

System:

VISS TVS, Janisol Türen Edelstahl

Architekt:

LAN (Local Architecture Network),
Paris/FR

Objet:

Centre d'archives EDF, Bure/FR

Système:

VISS TVS, portes Janisol acier Inox

Architecte:

LAN (Local Architecture Network), Paris/
FR

Project:

Central archive EDF, Bure/FR

System:

VISS TVS, Janisol doors stainless steel

Architect:

LAN (Local Architecture Network),
Paris/FR

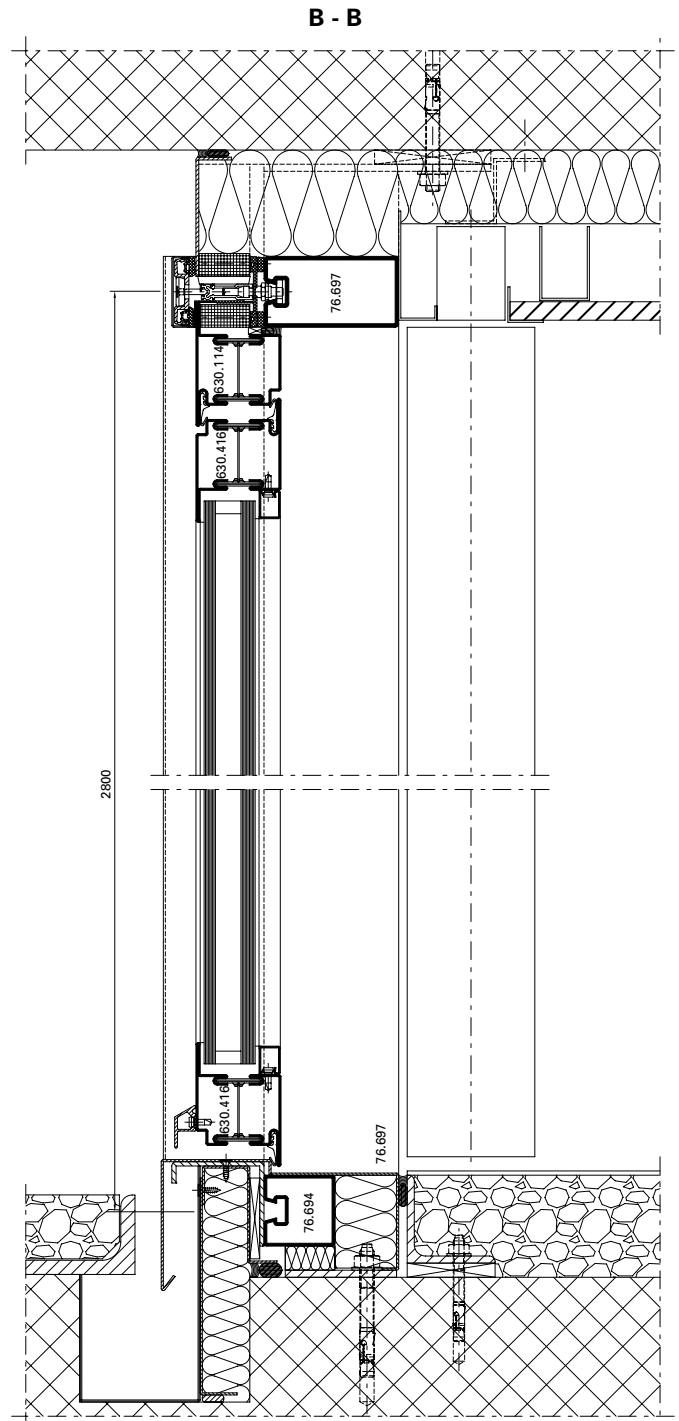

A - A

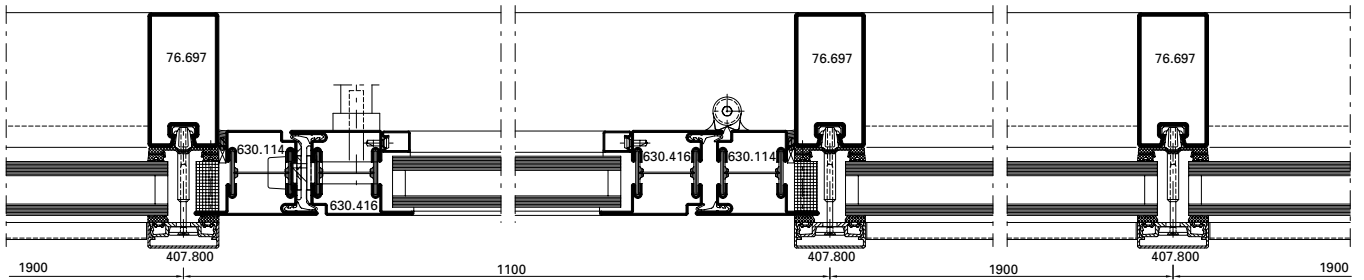

B

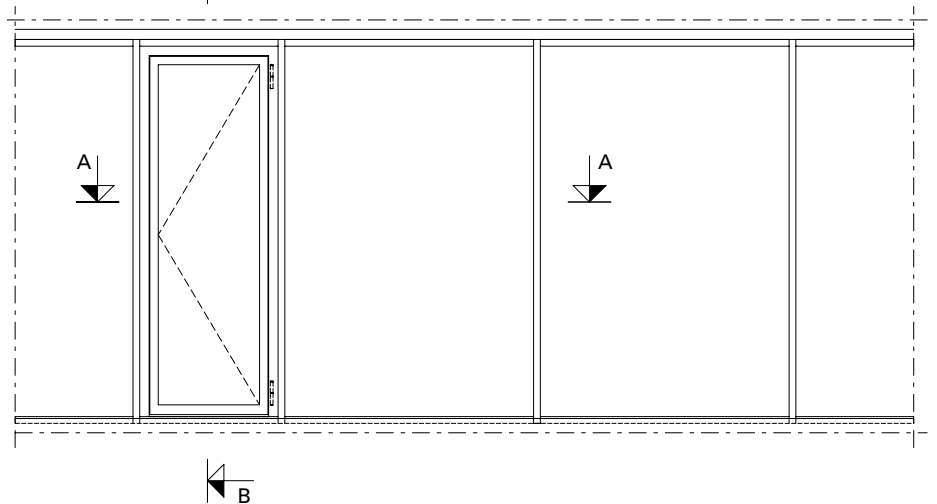

Ausgeführte Objekte

Objets réalisés

Completed projects

Objekt:

Gemeindehaus,
Ruidellots de la Selva/ES

System:

VISS TVS

Architekt:

Pla & Padrosa S.A., Girona/ES

Objet:

Hôtel de ville,
Ruidellots de la Selva/ES

Système:

VISS TVS

Architecte:

Pla & Padrosa S.A., Girona/ES

Project:

Town hall,
Ruidellots de la Selva/ES

System:

VISS TVS

Architect:

Pla & Padrosa S.A., Girona/ES

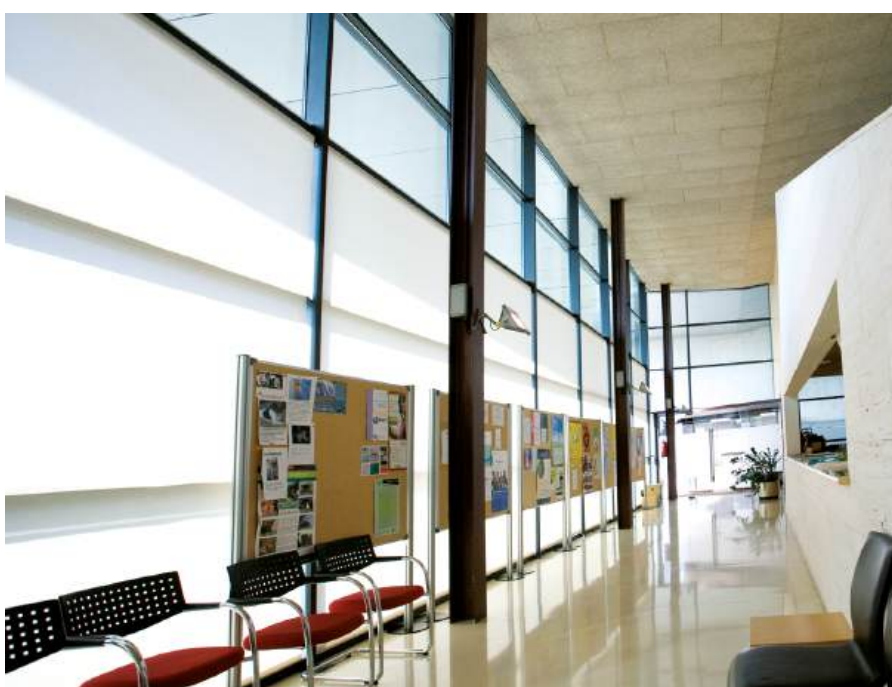

Objekt:

Hauptbahnhof, Köln/DE

System:

VISS TV, Jansen-Economy 50 Türen,
Janisol Türen Edelstahl

Architekt:

Kopka und Theil Architekten,
Dortmund/DE

Objet:

Gare centrale, Cologne/DE

Système:

VISS TV, portes Jansen-Economy 50,
portes Janisol acier Inox

Architecte:

Kopka und Theil Architekten,
Dortmund/DE

Project:

Central station, Cologne/DE

System:

VISS TV, Jansen-Economy 50 doors,
Janisol stainless steel doors

Architect:

Kopka und Theil Architekten,
Dortmund/DE



Fotos: Jochen Helle, Dortmund



Ausgeführte Objekte Objets réalisés Completed projects

Objekt:

UNIL, Universität Lausanne «Géopolis»,
Lausanne/CH

System:

VISS Fire, VISS TV, Janisol 2 EI30

Architekt:

Itten + Brechbühl Architekten,
Büro Lausanne, Lausanne/CH

Objet:

UNIL, Université de Lausanne
«Géopolis», Lausanne/CH

Système:

VISS Fire, VISS TV, Janisol 2 EI30

Architecte:

Itten + Brechbühl Architekten,
Büro Lausanne, Lausanne/CH

Project:

UNIL, University of Lausanne
«Géopolis», Lausanne/CH

System:

VISS Fire, VISS TV, Janisol 2 EI30

Architect:

Itten + Brechbühl Architekten,
Büro Lausanne, Lausanne/CH

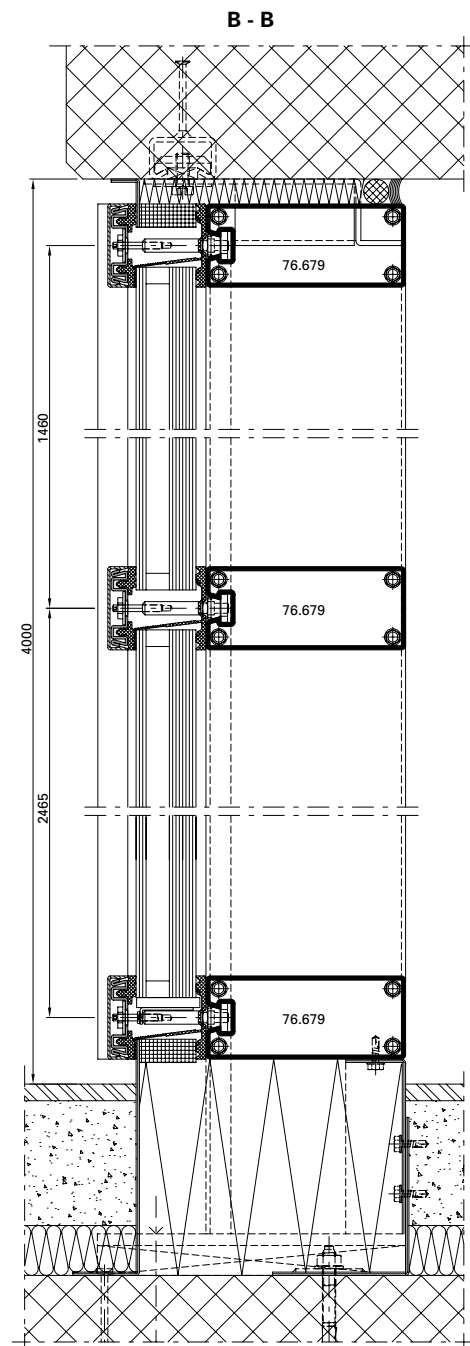

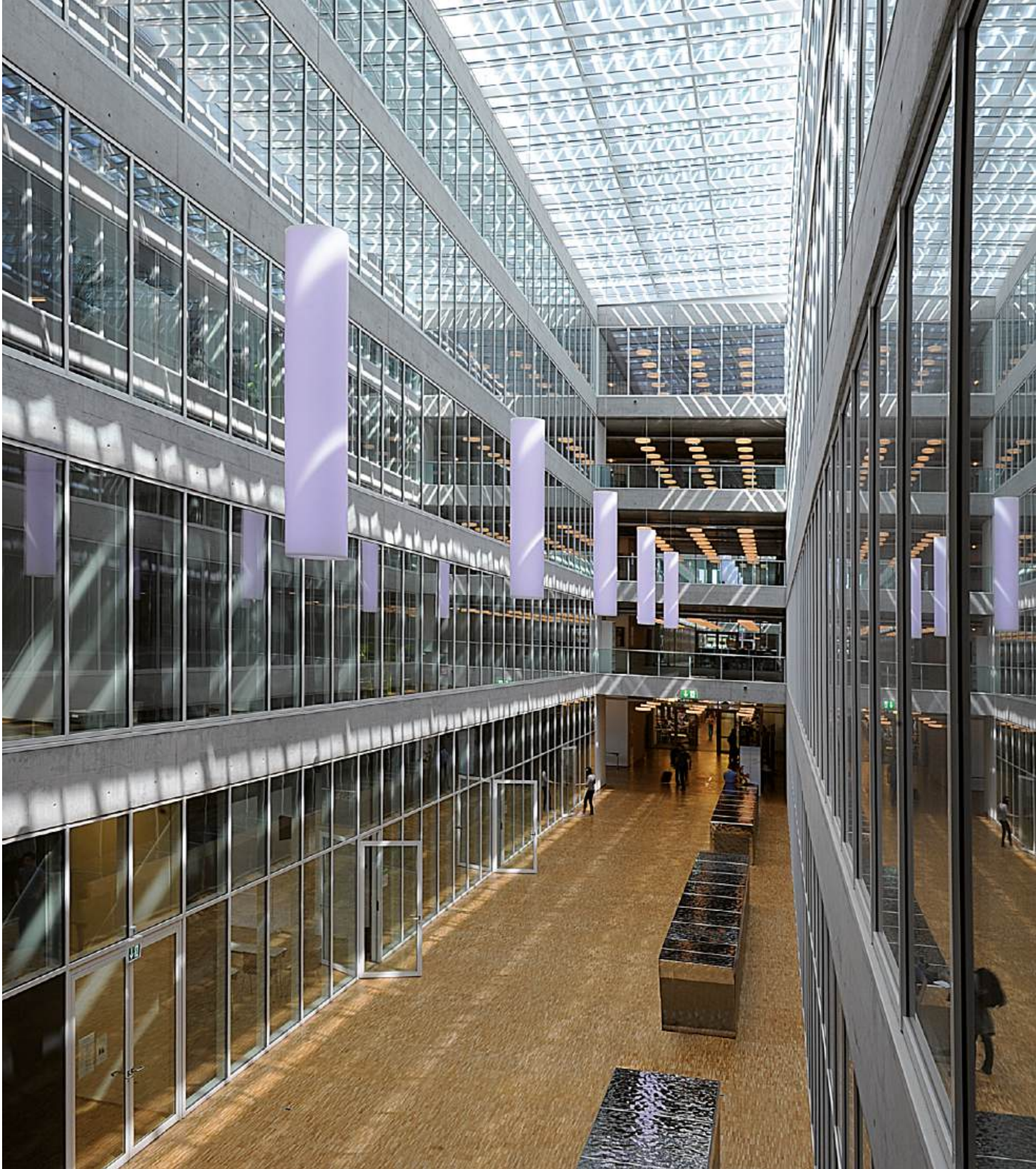

A - A

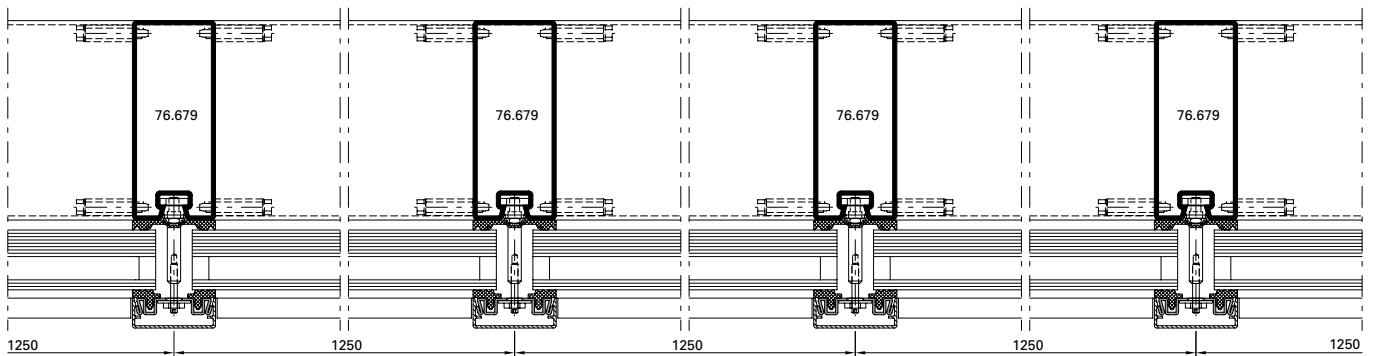

Ausgeführte Objekte

Objets réalisés

Completed projects

Objekt:

Jansen AG, Campus, Oberriet/CH

System:

VISS SG

Architekt:

Davide Macullo Architects, Lugano/CH

Objet:

Jansen AG, Campus, Oberriet/CH

Système:

VISS SG

Architecte:

Davide Macullo Architects, Lugano/CH

Project:

Jansen AG, Campus, Oberriet/CH

System:

VISS SG

Architect:

Davide Macullo Architects, Lugano/CH

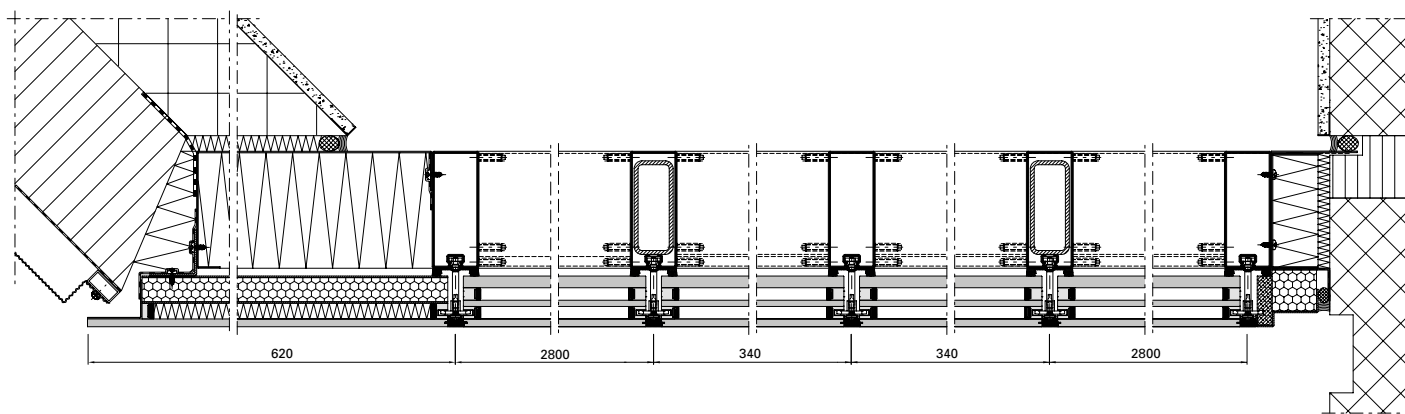

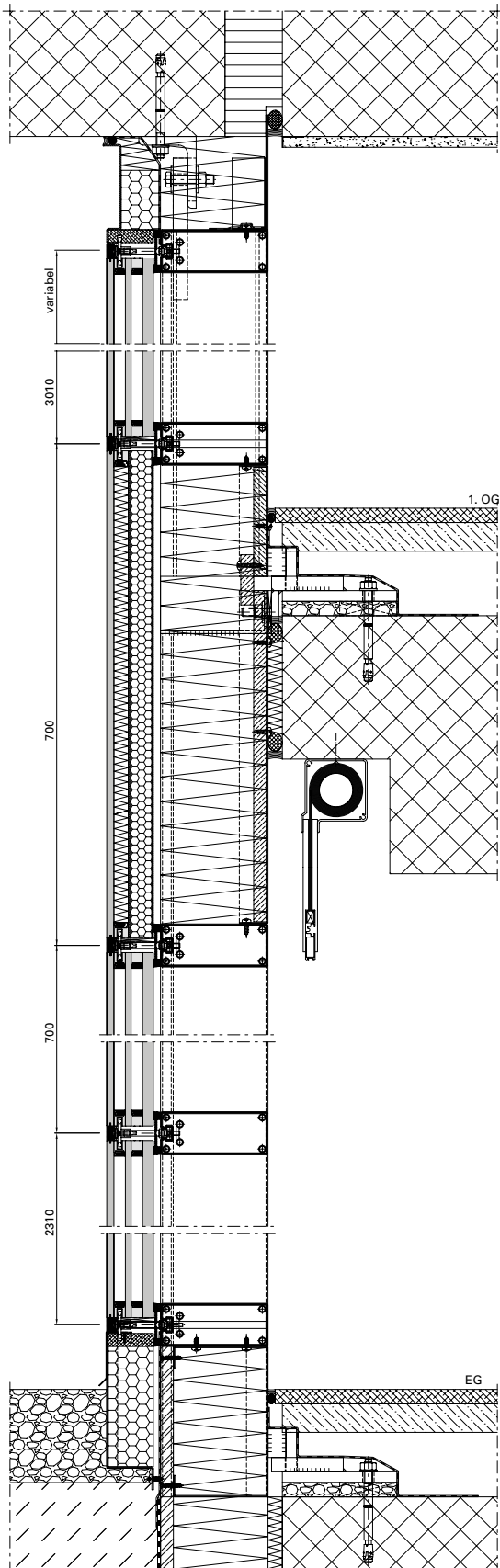

Ausgeführte Objekte

Objets réalisés

Completed projects

Objekt:

Bildungsforum, Potsdam/DE

System:

VISS TVS HI, VISS Fire

Architekt:

Reiner Becker Architekten BDA, Berlin/
DE

Objet:

Forum de formation, Potsdam/DE

Système:

VISS TVS HI, VISS Fire

Architecte:

Reiner Becker Architekten BDA, Berlin/
DE

Project:

Education forum, Potsdam/DE

System:

VISS TVS HI, VISS Fire

Architect:

Reiner Becker Architekten BDA, Berlin/
DE





Fotos: Stephan Falk, Berlin



Ausgeführte Objekte

Objets réalisés

Completed projects

Objekt:

Besucherzentrum «Alte Wasserzentrale», Pietra Neamt/RO

System:

VISS TVS

Architekt:

ZIP & BDX Studio, Marius Calin, Bukarest/RO

Objet:

Centre de visiteurs «ancienne centrale des eaux», Pietra Neamt/RO

Système:

VISS TVS

Architecte:

ZIP & BDX Studio, Marius Calin, Bukarest/RO

Project:

Visitor centre «old water station», Pietra Neamt/RO

System:

VISS TVS

Architect:

ZIP & BDX Studio, Marius Calin, Bukarest/RO

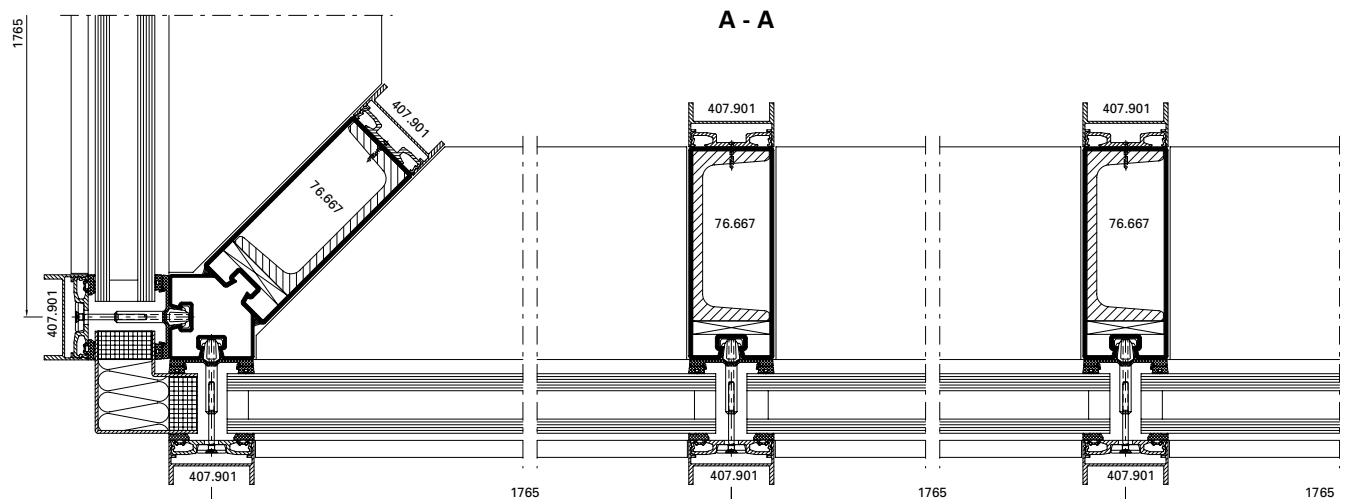

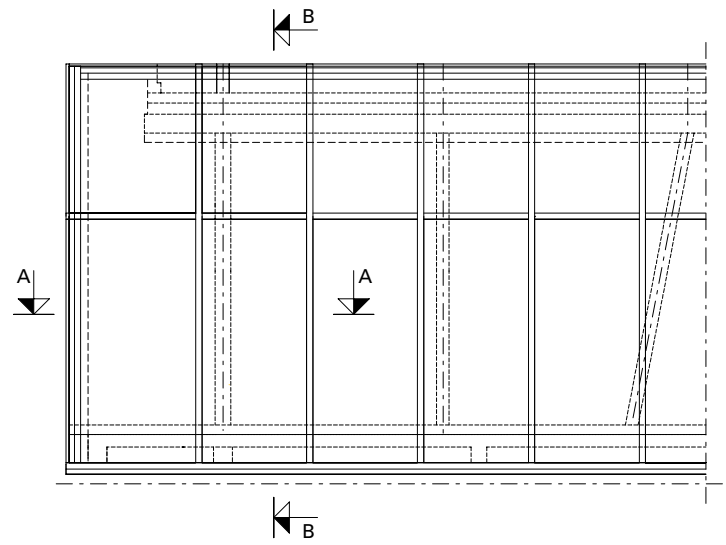
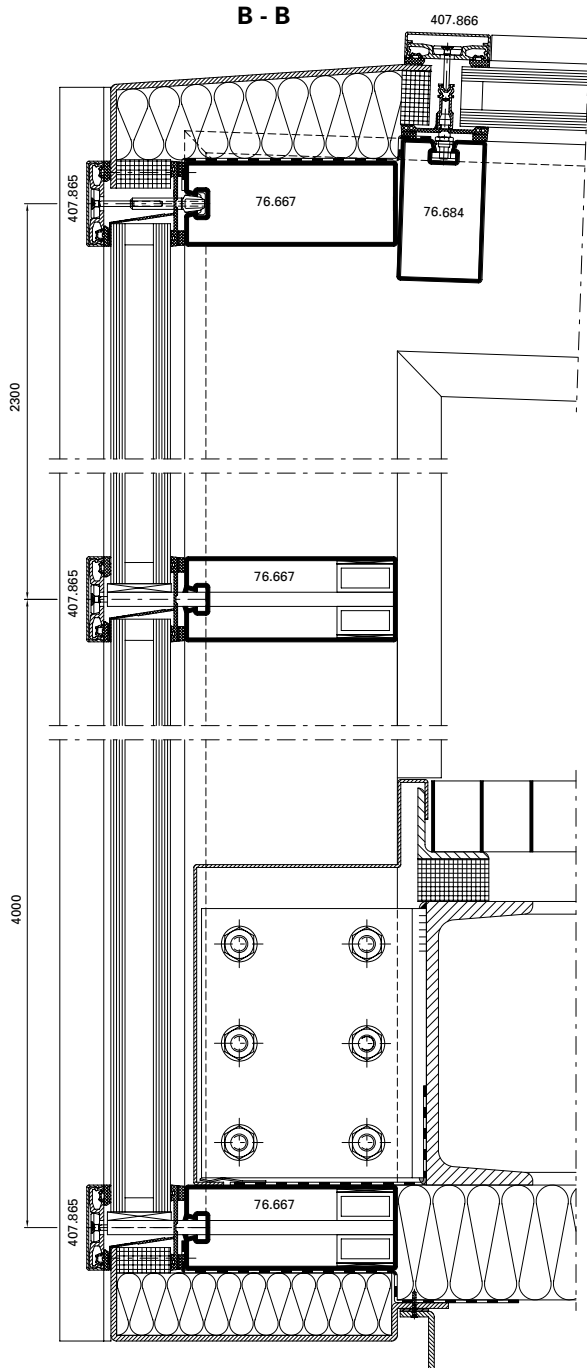

Ausgeführte Objekte

Objets réalisés

Completed projects

Objekt:

Hotel Novi Spa,
Novi Vinodolski/HR

System:

VISS TV Linea

Architekt:

Architekturstudio Banas und Cimas,
Rijeka/HR

Objet:

Hôtel Novi Spa,
Novi Vinodolski/HR

Système:

VISS TV Linea

Architecte:

Architekturstudio Banas und Cimas,
Rijeka/HR

Project:

Novi Spa Hotel,
Novi Vinodolski/HR

System:

VISS TV Linea

Architect:

Architekturstudio Banas und Cimas,
Rijeka/HR



Objekt:

Solvias AG, Büro- und Lagergebäude, Kaiseraugst/CH

System:

VISS TV Linea

Architekt:

Zwimpfer Partner Architekten, Basel/CH

Objet:

Solvias AG, immeuble de bureaux et d'entrepôt, Kaiseraugst/CH

Système:

VISS TV Linea

Architecte:

Zwimpfer Partner Architekten, Bâle/CH

Project:

Solvias AG, office and warehouse facility, Kaiseraugst/CH

System:

VISS TV Linea

Architect:

Zwimpfer Partner Architekten, Basle/CH



Ausgeführte Objekte

Objets réalisés

Completed projects

Objekt:

Médiathèque, Pau/FR

System:

VISS Fire EW60, VISS Basic,
Janisol 3 E160

Architekt:

CANAL, Paris/FR

Objet:

Médiathèque, Pau/FR

Système:

VISS Fire EW60, VISS Basic,
Janisol 3 E160

Architecte:

CANAL, Paris/FR

Project:

Médiathèque, Pau/FR

System:

VISS Fire EW60, VISS Basic,
Janisol 3 E160

Architect:

CANAL, Paris/FR



A - A

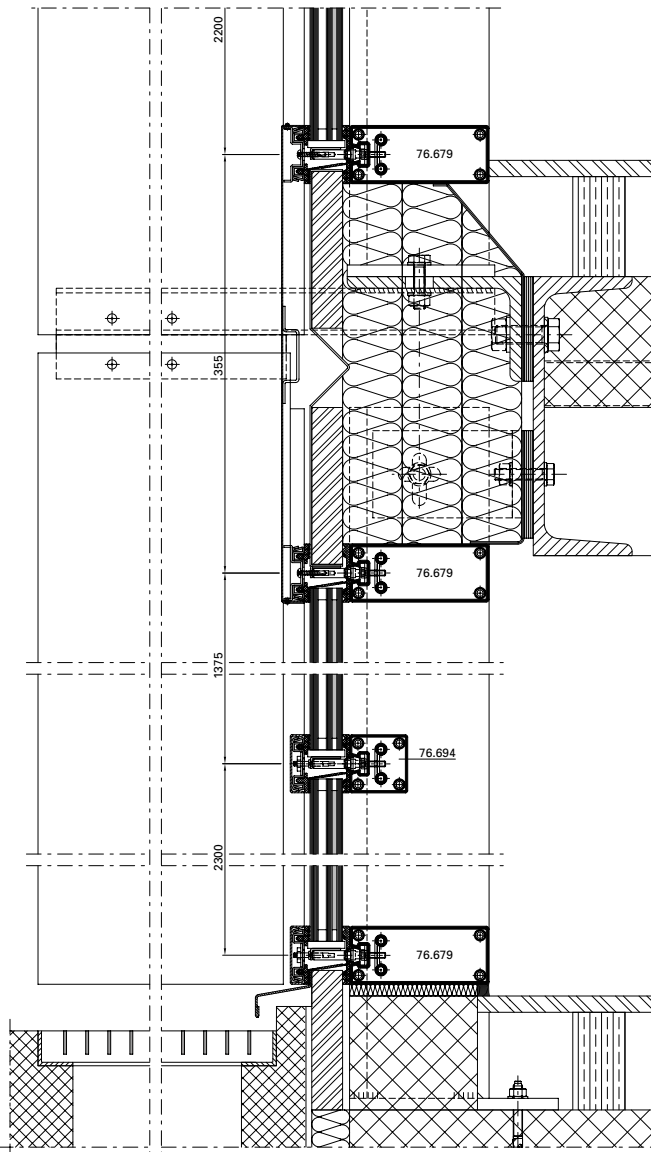

B - B

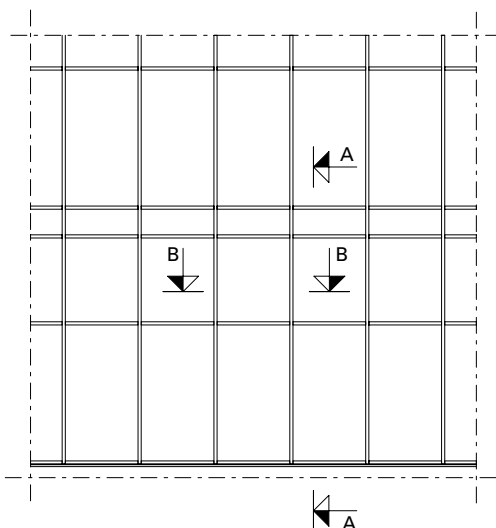
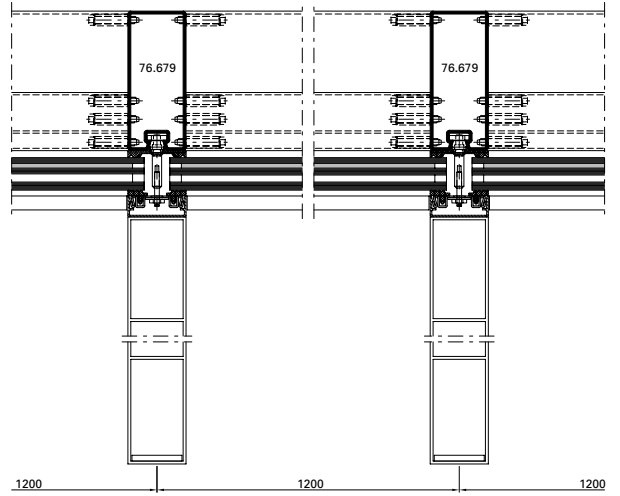

Ausgeführte Objekte Objets réalisés Completed projects

Objekt:

«Mumuth» Haus für Musik & Musiktheater der Kunstuniversität, Graz/AT

System:

VISS TVS

Architekt:

UNStudio, Arch. Ben van Berkel en Bos, Amsterdam/NL

Objet:

«Mumuth» Maison de la musique & du théâtre musical de l'université des arts, Grace/AT

Système:

VISS TVS

Architecte:

UNStudio, Arch. Ben van Berkel en Bos, Amsterdam/NL

Project:

«Mumuth» House of Music & Music Drama at the University of Music and Performing Arts, Graz/AT

System:

VISS TVS

Architect:

UNStudio, Arch. Ben van Berkel en Bos, Amsterdam/NL



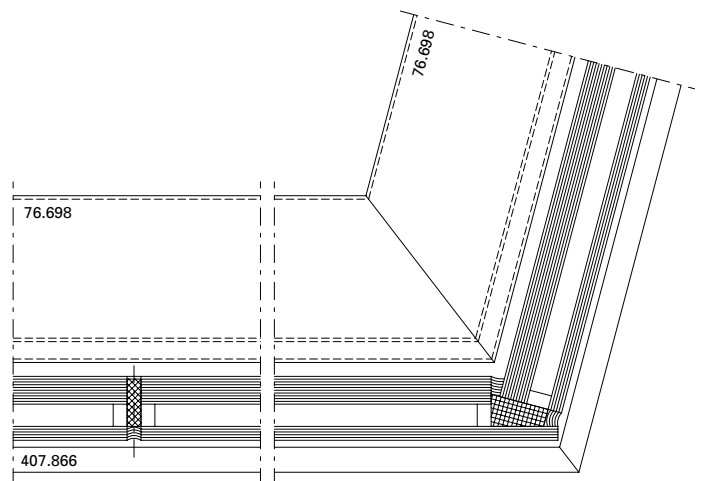
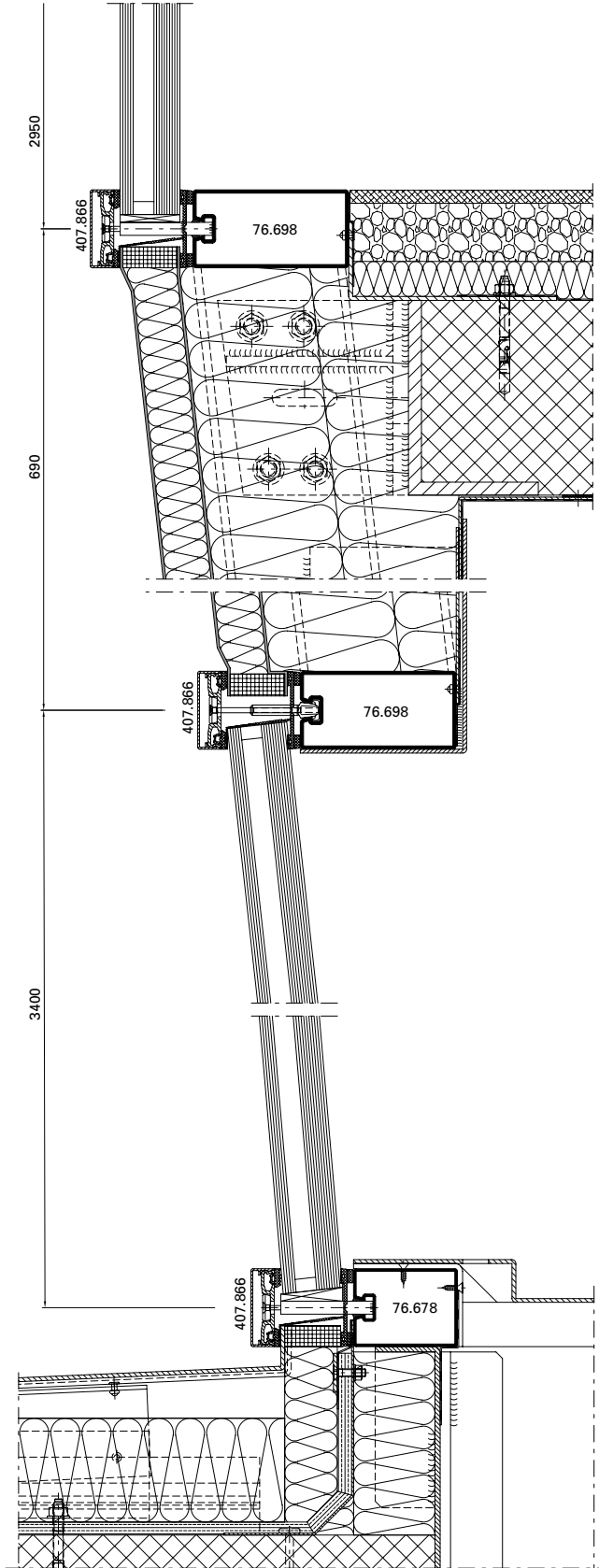

Ausgeführte Objekte
Objets réalisés
Completed projects



Project:

Centre Pompidou, Metz/FR

System:

VISS Fire EI60,
Jansen-Economy 50 E30

Architect:

Shigeru Ban Architects, Paris/FR

Objet:

Centre Pompidou, Metz/FR

Système:

VISS Fire EI60,
Jansen-Economy 50 E30

Architecte:

Shigeru Ban Architects, Paris/FR

Objekt:

Centre Pompidou, Metz/FR

System:

VISS Fire EI60,
Jansen-Economy 50 E30

Architekt:

Shigeru Ban Architects, Paris/FR



Objekt:

Alters- und Pflegeheim,
Burgdorf/CH

System:

VISS Basic TV

Architekt:

Gauer Itten Messerli Architekten AG,
Bern/CH

Objet:

Home pour personnes âgées, Burgdorf/
CH

Système:

VISS Basic TV

Architecte:

Gauer Itten Messerli Architekten AG,
Bern/CH

Project:

Old-age and nursing home, Burgdorf/
CH

System:

VISS Basic TV

Architect:

Gauer Itten Messerli Architekten AG,
Bern/CH

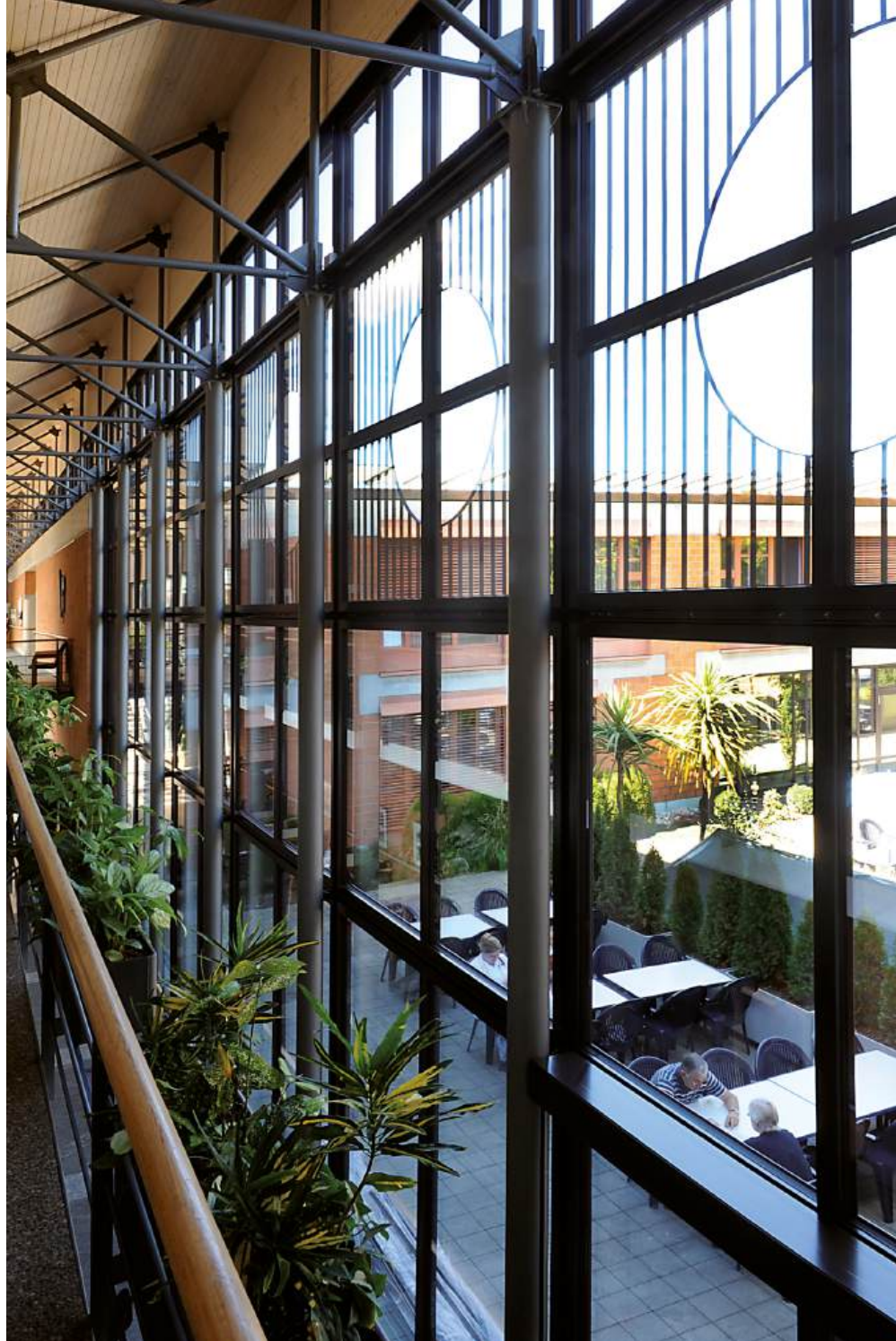

Ausgeführte Objekte

Objets réalisés

Completed projects

Objekt:

Drents Museum, Assen/NL

System:

VISS Basic TV,
Jansen-Economy 50 EW60

Architekt:

Designed by Erick van Egeraat,
Rotterdam/NL

Objet:

Musée Drents, Assen/NL

Système:

VISS Basic TV,
Jansen-Economy 50 EW60

Architecte:

Designed by Erick van Egeraat,
Rotterdam/NL

Project:

Drents Museum, Assen/NL

System:

VISS Basic TV,
Jansen-Economy 50 EW60

Architect:

Designed by Erick van Egeraat,
Rotterdam/NL



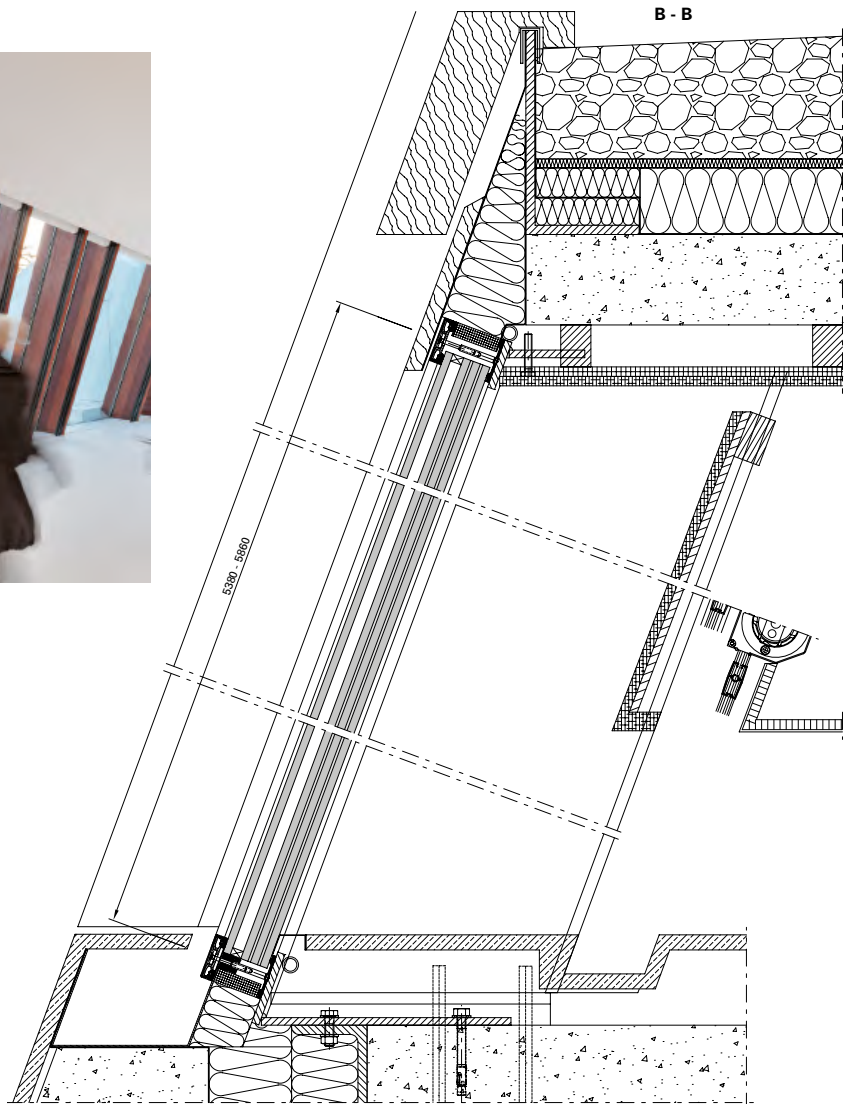
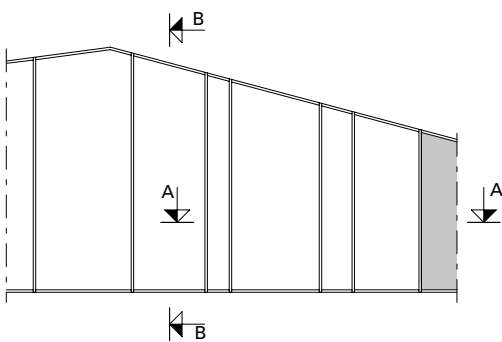
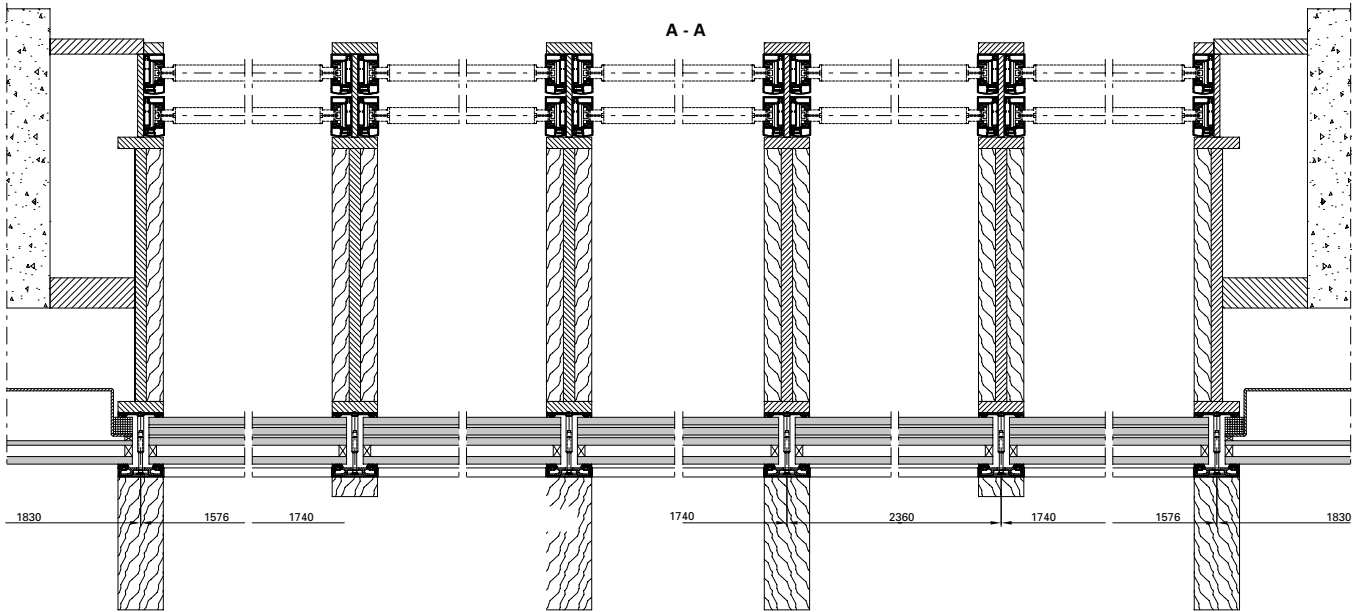

Ausgeführte Objekte Objets réalisés Completed projects

Objekt:

Akkustik-Tunnels,
Warschau/PL

System:

VISS Basic TVS (schräg)

Architekt:

Transprojekt, Warschau/PL
FOROOM Bartłomiej Grotte,
Warschau/PL

Objet:

Tunnels acoustiques,
Varsovie/PL

Système:

VISS Basic TVS (oblique)

Architecte:

Transprojekt, Varsovie/PL
FOROOM Bartłomiej Grotte,
Varsovie/PL

Project:

Acoustic tunnels,
Warsaw/PL

System:

VISS Basic TVS (sloping)

Architect:

Transprojekt, Warsaw/PL
FOROOM Bartłomiej Grotte,
Warsaw/PL

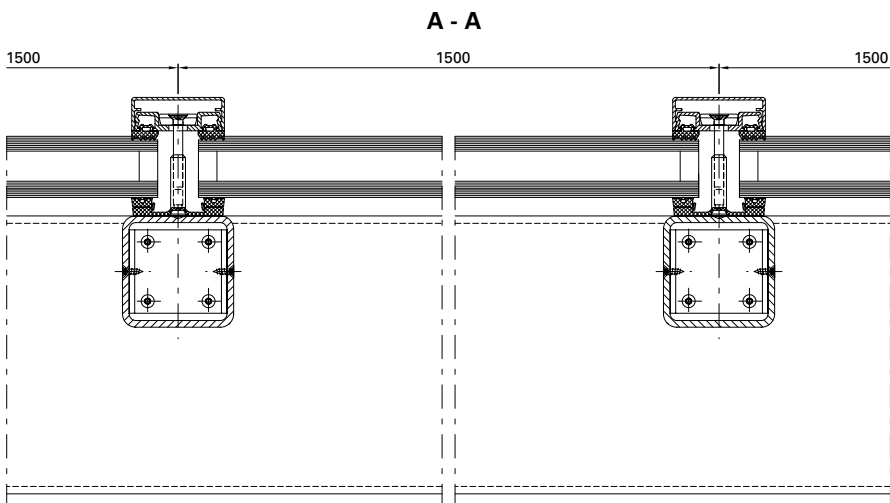

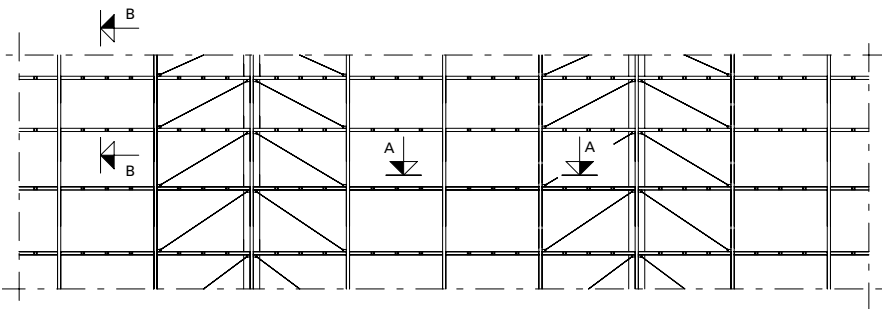
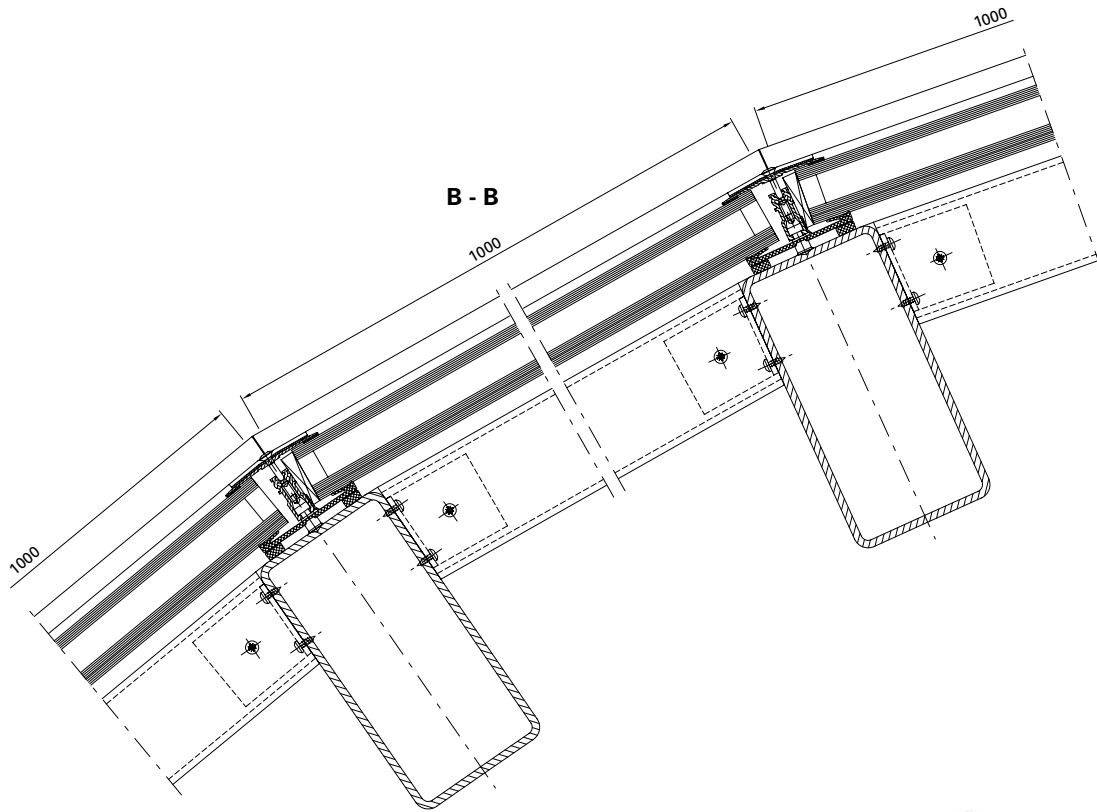

Ausgeführte Objekte

Objets réalisés

Completed projects

Objekt:

Jin Ji Hu Kempinski Hotel, Suzhou/CN

System:

VISS TV

Architekt:

Suzhou Architecture and Design
Institute, Shanghai/CN

Objet:

Hôtel Jin Ji Hu Kempinski, Suzhou/CN

Système:

VISS TV

Architecte:

Suzhou Architecture and Design
Institute, Shanghai/CN

Project:

Jin Ji Hu Kempinski Hotel, Suzhou/CN

System:

VISS TV

Architect:

Suzhou Architecture and Design
Institute, Shanghai/CN



Objekt:

Historisches Museum,
Kharkov/UA

System:

VISS I_xtra, Janisol Türen

Architekt:

S. Chechelnytskiy, M. Polivanova,
T. Polivanova, Kharkov/UA

Objet:

Musée historique,
Kharkov/UA

Système:

VISS I_xtra, portes Janisol

Architecte:

S. Chechelnytskiy, M. Polivanova,
T. Polivanova, Kharkov/UA

Project:

Historical museum,
Kharkov/UA

System:

VISS I_xtra, Janisol doors

Architect:

S. Chechelnytskiy, M. Polivanova,
T. Polivanova, Kharkov/UA

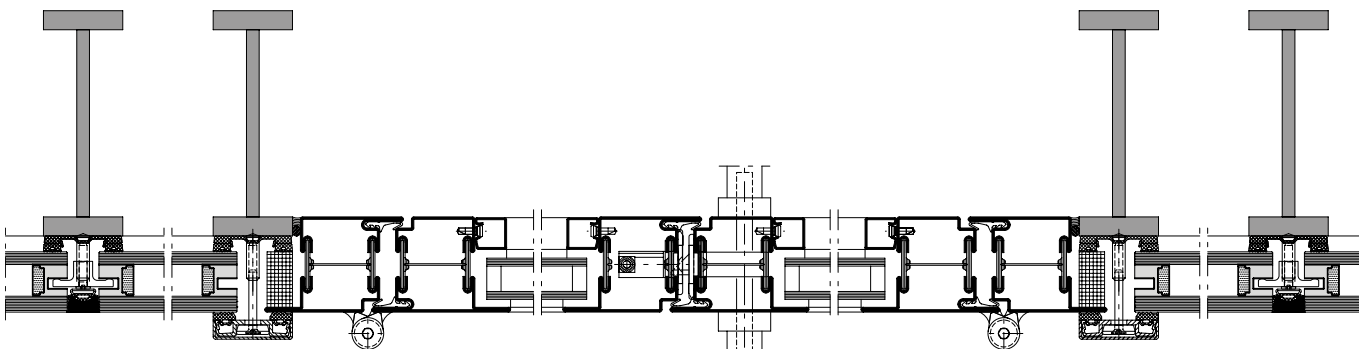

Ausgeführte Objekte Objets réalisés Completed projects

Objekt:

Kunstgebäude, Stuttgart/DE

System:

VISS TVS (schräg)

Architekt:

Harder III Stumpf, Freie Architekten,
Stuttgart/DE

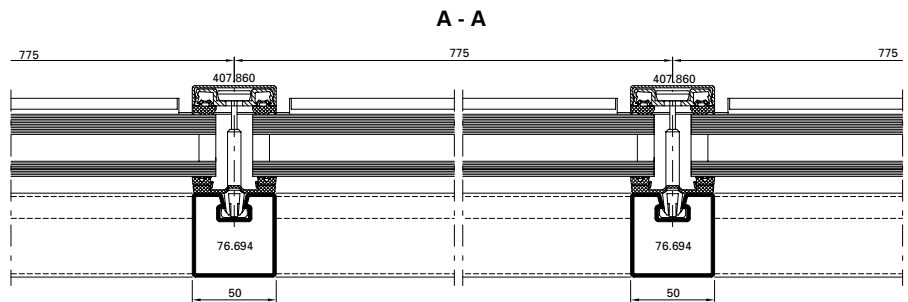
**Objet:**

Bâtiment des arts, Stuttgart/DE

Système:

VISS TVS (oblique)

Architecte:

Harder III Stumpf, Freie Architekten,
Stuttgart/DE

Project:

Art building, Stuttgart/DE

System:

VISS TVS (sloping)

Architect:

Harder III Stumpf, Freie Architekten,
Stuttgart/DE



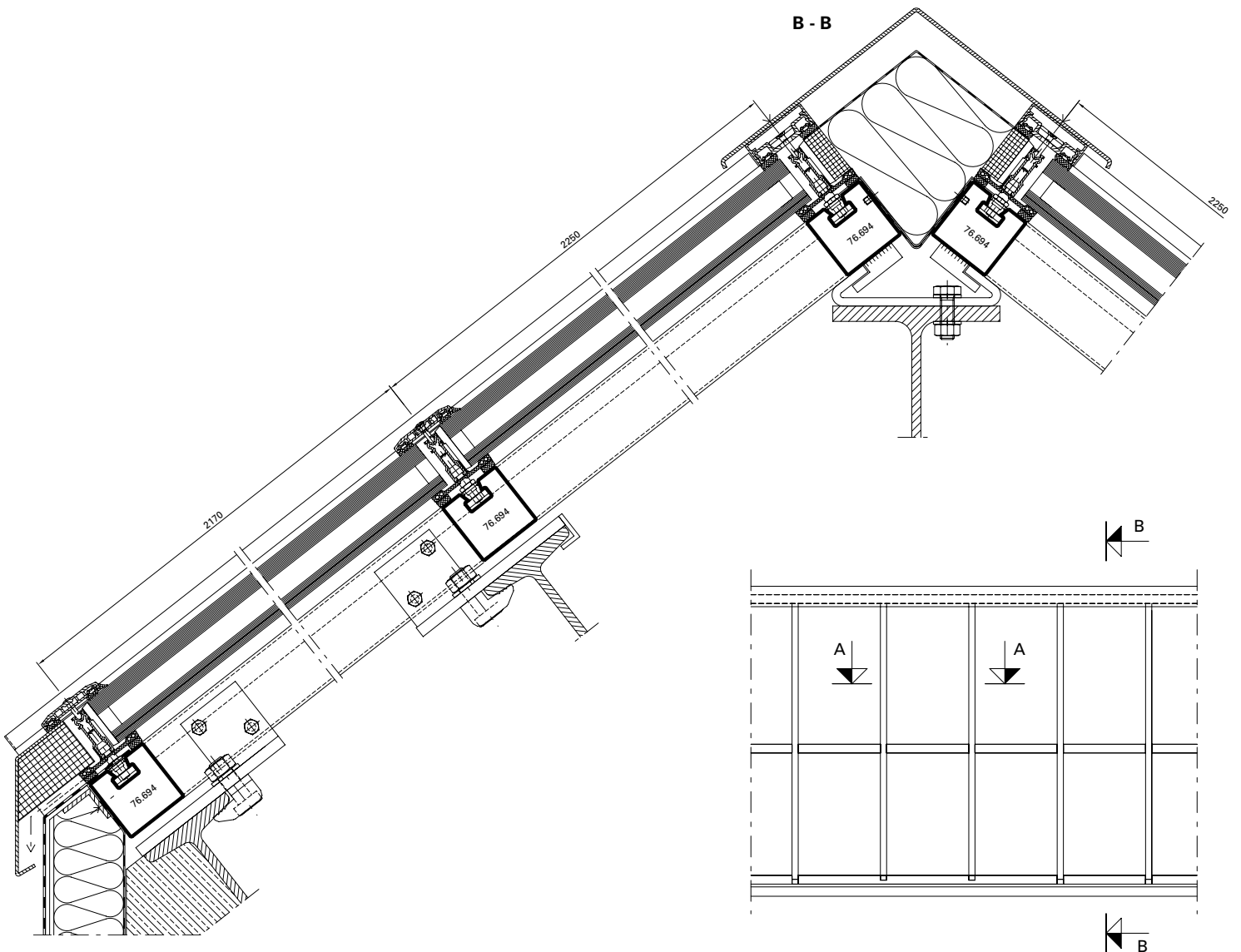

Ausgeführte Objekte

Objets réalisés

Completed projects

Objekt:

3-Feldsporthalle, Ingelfingen/DE

System:

VISS TVS HI, VISS Fire E30/E90, Janisol Primo, Janisol Türen, Janisol 2 E130, Jansen-Economy 60

Architekt:

Hein, Hüttel und Lindenberger, Ludwigsburg/DE

Objet:

Salle de sport triple, Ingelfingen/DE

Système:

VISS TVS HI, VISS Fire E30/E90, Janisol Primo, portes Janisol, Janisol 2 E130, Jansen-Economy 60

Architecte:

Hein, Hüttel und Lindenberger, Ludwigsburg/DE

Project:

3-field sports hall, Ingelfingen/DE

System:

VISS TVS HI, VISS Fire E30/E90, Janisol Primo, Janisol doors, Janisol 2 E130, Jansen-Economy 60

Architect:

Hein, Hüttel und Lindenberger, Ludwigsburg/DE

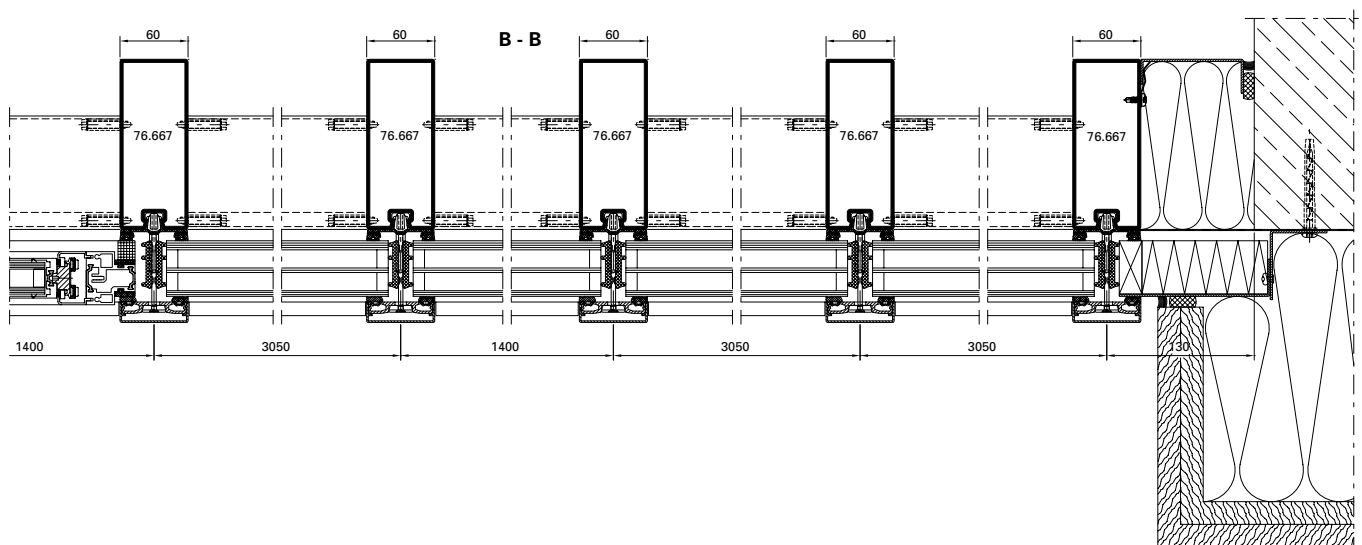

A - A

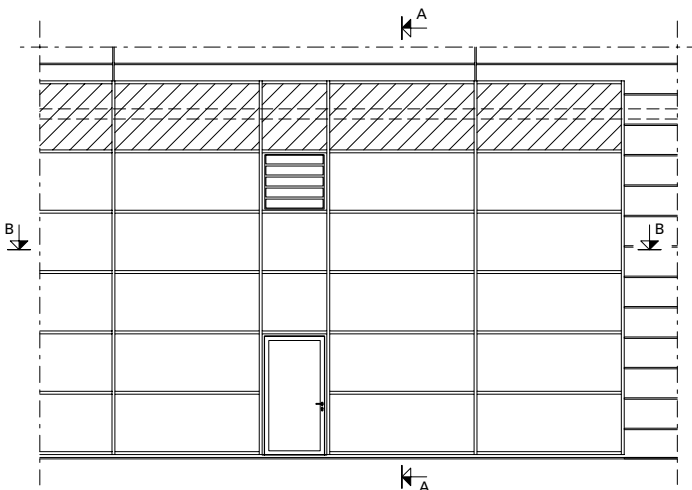
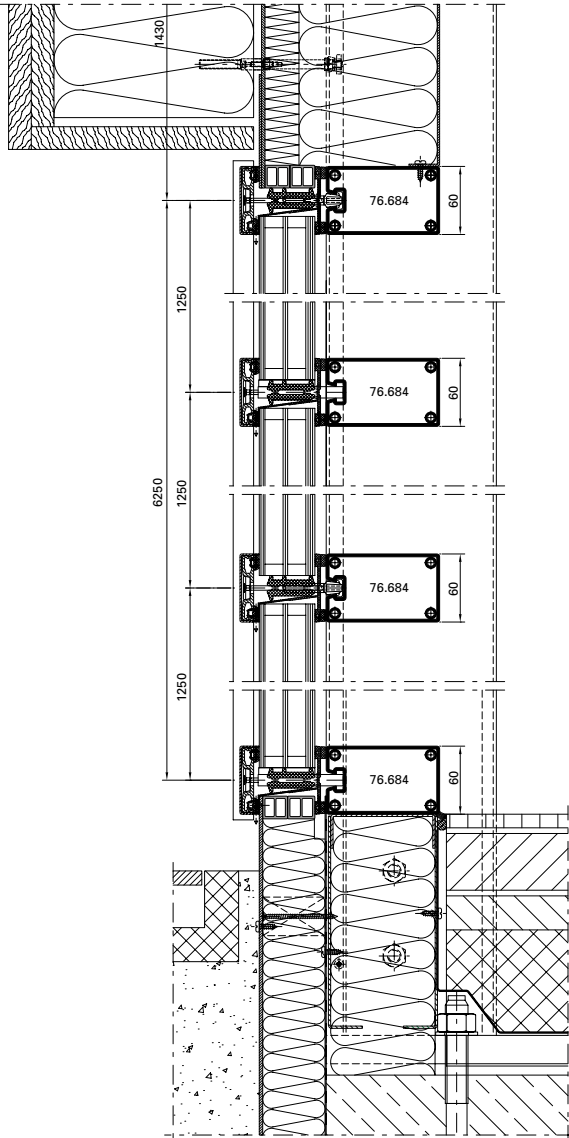

Ausgeführte Objekte

Objets réalisés

Completed projects

Objekt:

Musikkonservatorium, Bilbao/ES

System:

VISS TVS

Architekt:

Roberto Ercilla Arquitectura,
Vitoria/ES

Objet:

Conservatoire de musique, Bilbao/ES

Système:

VISS TVS

Architecte:

Roberto Ercilla Arquitectura,
Vitoria/ES

Project:

Conservatory of Music, Bilbao/ES

System:

VISS TVS

Architect:

Roberto Ercilla Arquitectura,
Vitoria/ES



Objekt:

Landesberufsschule, Mureck/AT

System:

VISS TVS Linea

Architekt:

Architekten Domenig & Wallner
ZT GmbH, Graz/AT

Objet:

École professionnelle, Mureck/AT

Système:

VISS TVS Linea

Architecte:

Architekten Domenig & Wallner
ZT GmbH, Graz/AT

Project:

State vocational school, Mureck/AT

System:

VISS TVS Linea

Architect:

Architekten Domenig & Wallner
ZT GmbH, Graz/AT



Ausgeführte Objekte
Objets réalisés
Completed projects



Fotos: Jochen Helle, Dortmund

Objekt:

Hafencity Schule, Hamburg/DE

System:

VISS Fire E30 TVS vertikal und schräg,
Janisol Türen

Architekt:

Spengler-Wiescholek Architekten,
Hamburg/DE

Objet:

École Hafencity, Hamburg/DE

Système:

VISS Fire E30 TVS vertical et oblique,
Portes Janisol

Architecte:

Spengler-Wiescholek Architekten,
Hamburg/DE

Project:

Hafencity school, Hamburg/DE

System:

VISS Fire E30 TVS vertical and sloping,
Janisol doors

Architect:

Spengler-Wiescholek Architekten,
Hamburg/DE



A - A

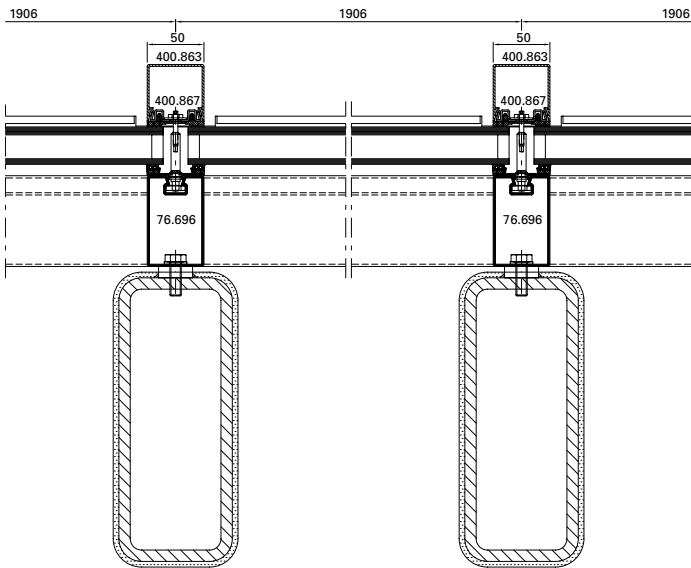

B

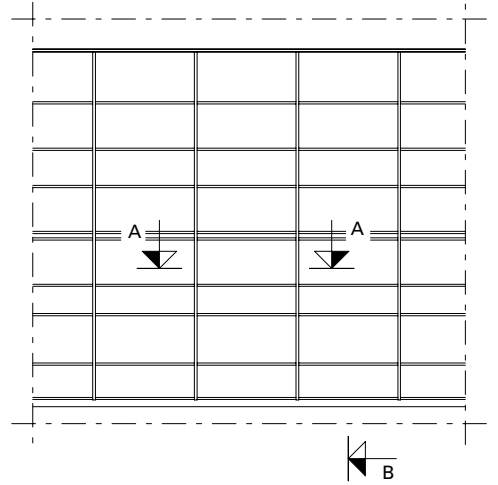

B - B

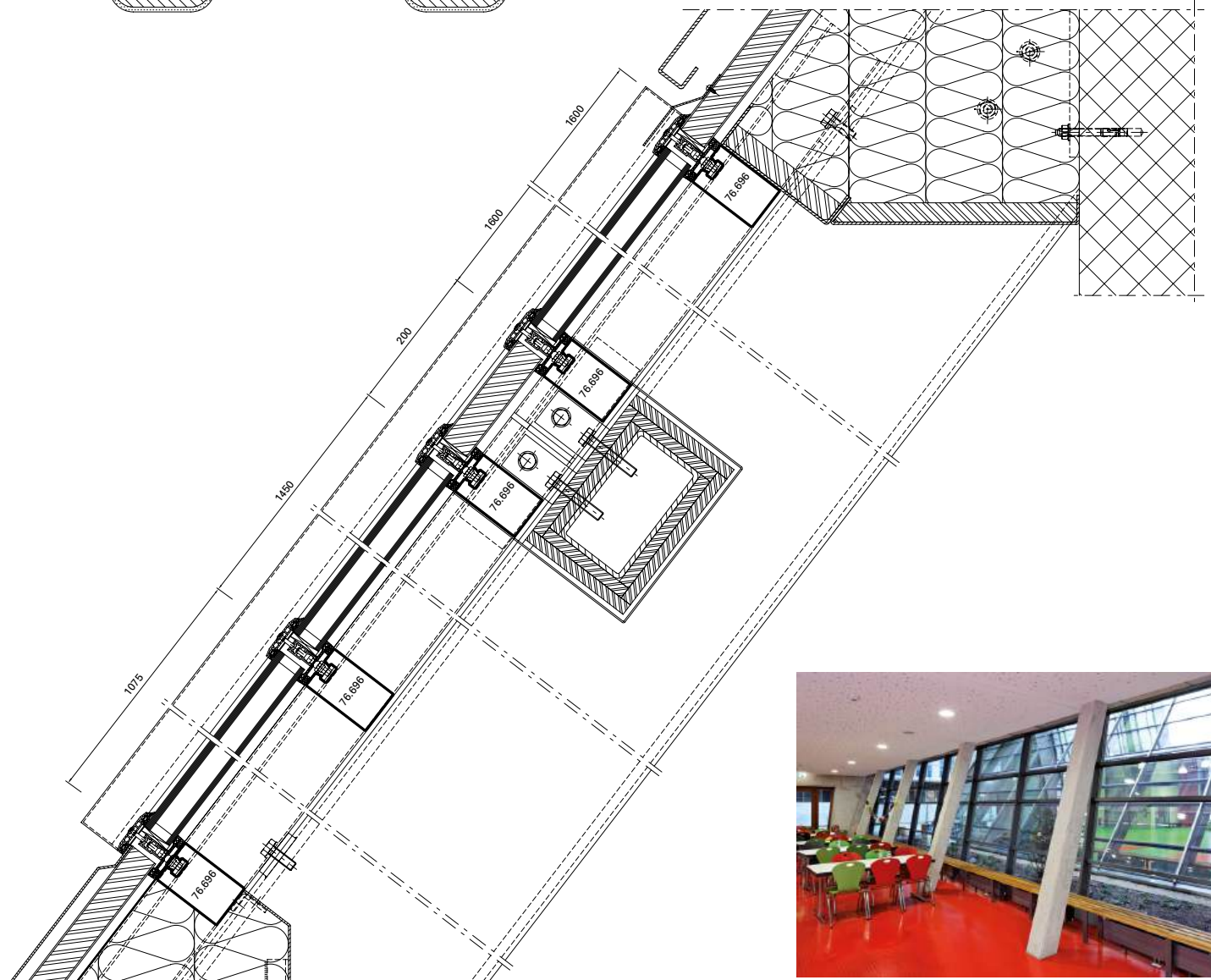

Ausgeführte Objekte

Objets réalisés

Completed projects

Objekt:

Drehrestaurant «Hoher Kasten»,
Brülisau/CH

System:

VISS Basic TVS

Architekt:

architekten : rlc ag, Rheineck/CH

Objet:

Restaurant panoramique
«Hoher Kasten», Brülisau/CH

Système:

VISS Basic TVS

Architecte:

architekten : rlc ag, Rheineck/CH

Project:

Revolving restaurant «Hoher Kasten»,
Brülisau/CH

System:

VISS Basic TVS

Architect:

architekten : rlc ag, Rheineck/CH

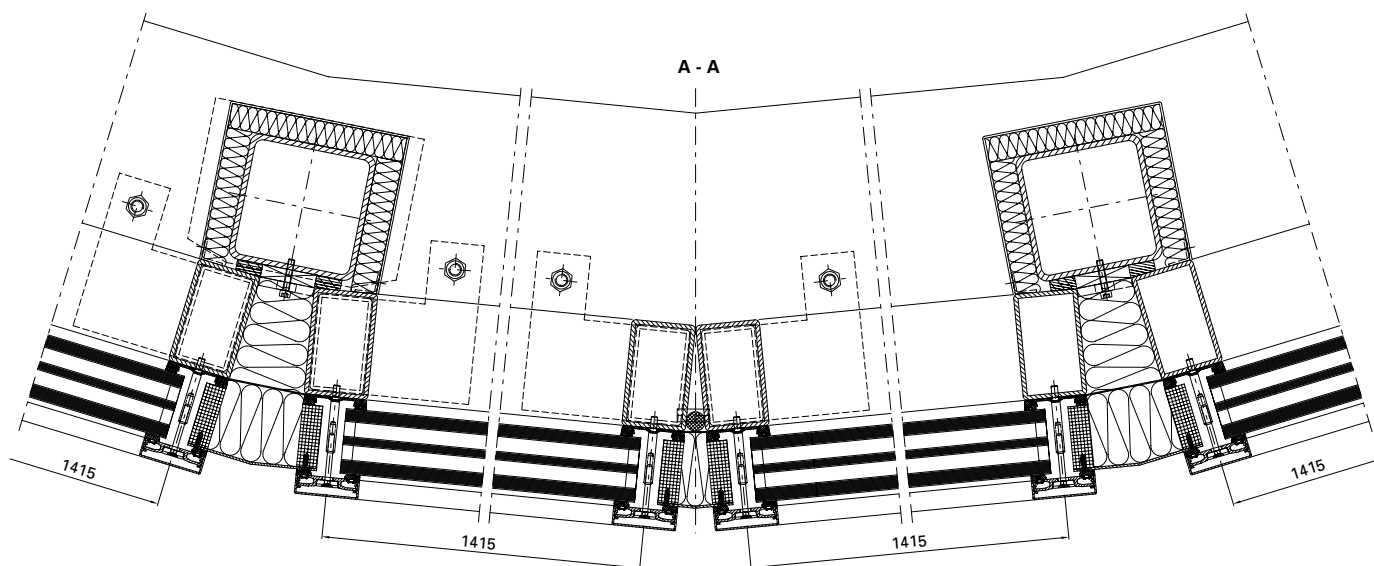

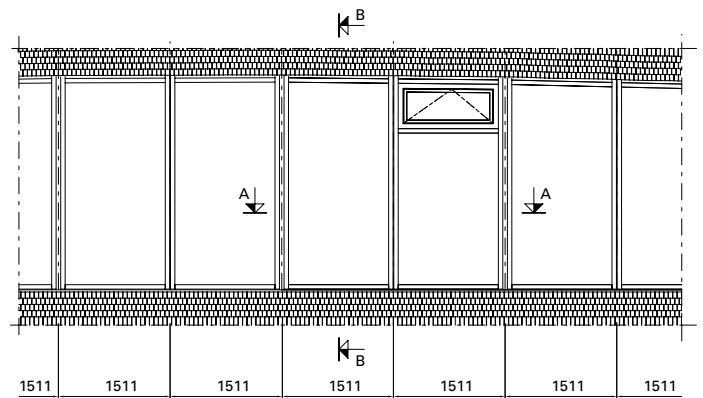
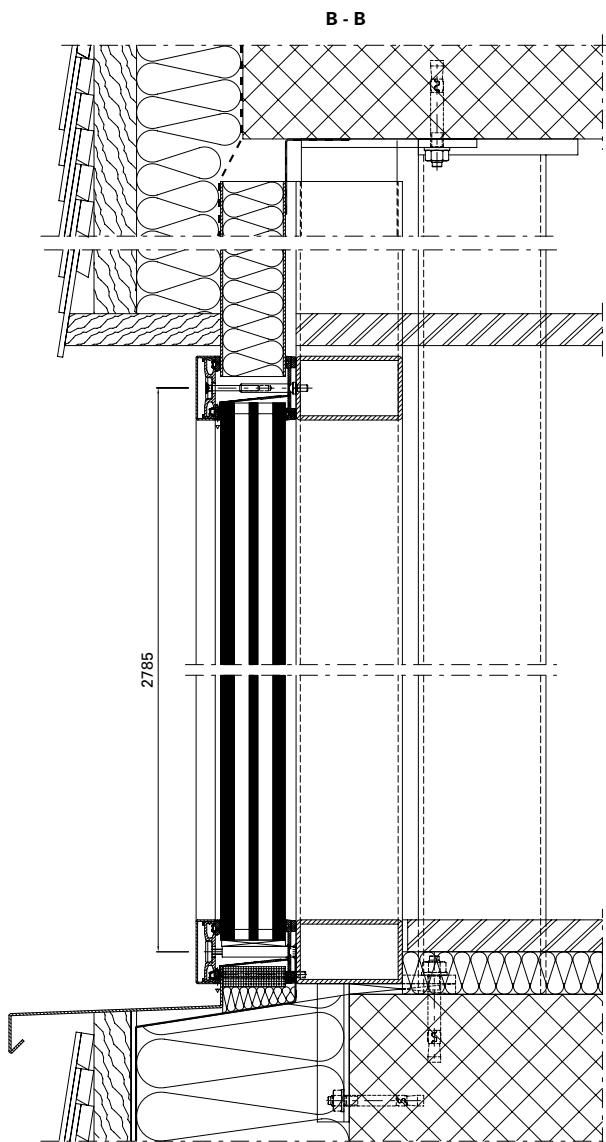

Ausgeführte Objekte

Objets réalisés

Completed projects

Objekt:

Hauptbahnhof «Rotterdam Centraal»,
Rotterdam/NL

System:

VISS Basic, VISS Fire, Janisol Türen

Architekt:

Team CS: Zusammenarbeit von
Bentham Crowel Architekten,
Meyer en Van Schooten Architecten
und West 8, Rotterdam/NL

Objet:

Gare centrale «Rotterdam Centraal»,
Rotterdam/NL

Système:

VISS Basic, VISS Fire, portes Janisol

Architecte:

Team CS: Coopération de Bentham
Crowel Architectes, Meyer en Van
Schooten Architectes et West 8,
Rotterdam/NL

Project:

Central station «Rotterdam Centraal»,
Rotterdam/NL

System:

VISS Basic, VISS Fire, Janisol doors

Architect:

Team CS: a cooperation of Bentham
Crowel Architects, Meyer en Van
Schooten Architects and West 8,
Rotterdam/NL

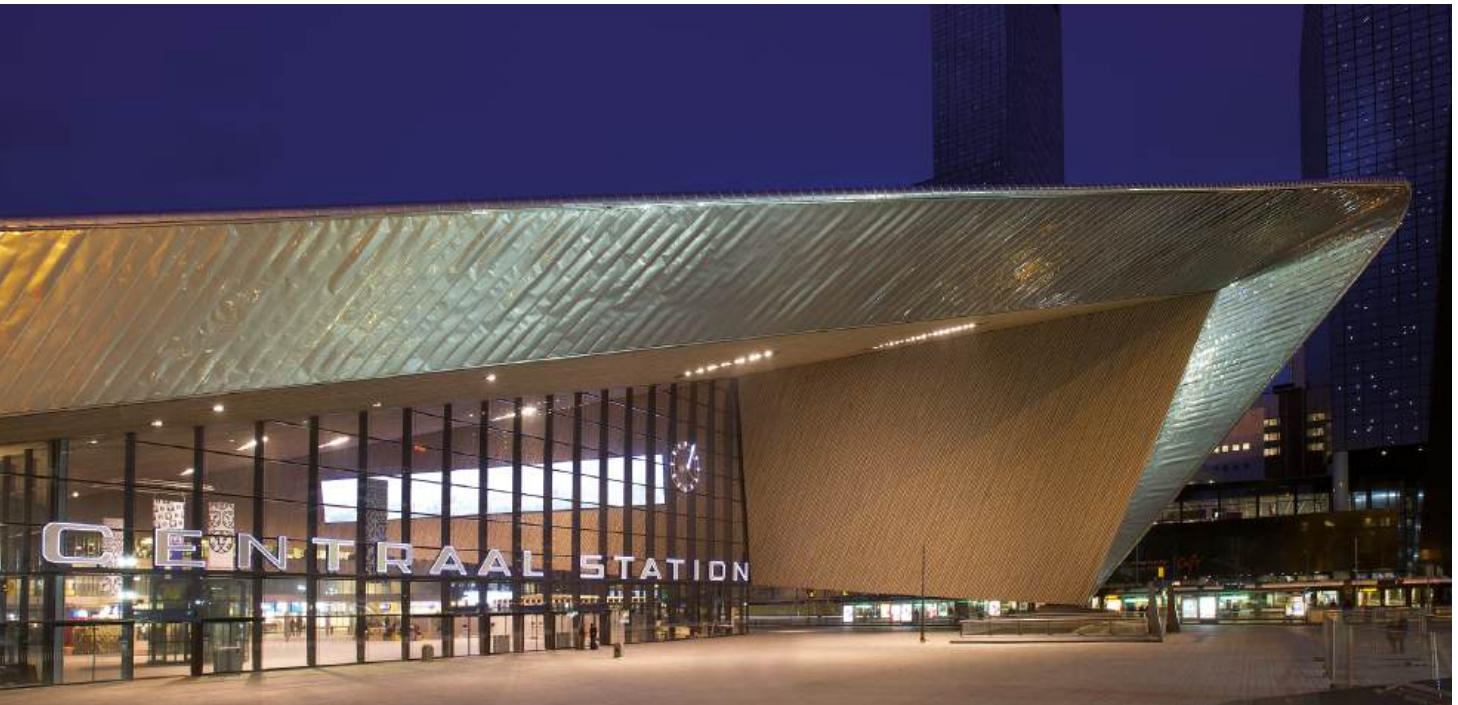



Ausgeführte Objekte

Objets réalisés

Completed projects

Objekt:

IGuzzini Illuminazione, Barcelona/ES

System:

VISS TVS, Janisol Fenster und Türen,
Jansen-Economy 50/60

Architekt:

Josep Mias, Mias Arquitectos ACTAR,
Barcelona/ES

Objet:

IGuzzini Illuminazione, Barcelone/ES

Système:

VISS TVS, Janisol portes et fenêtres,
Jansen-Economy 50/60

Architecte:

Josep Mias, Mias Arquitectos ACTAR,
Barcelone/ES

Project:

IGuzzini Illuminazione, Barcelona/ES

System:

VISS TVS, Janisol doors and windows,
Jansen-Economy 50/60

Architect:

Josep Mias, Mias Arquitectos ACTAR,
Barcelona/ES



Fotos: Adria Goula

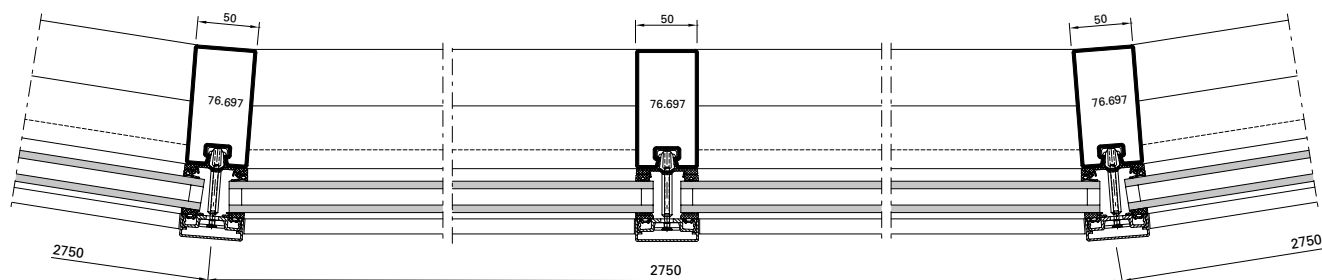

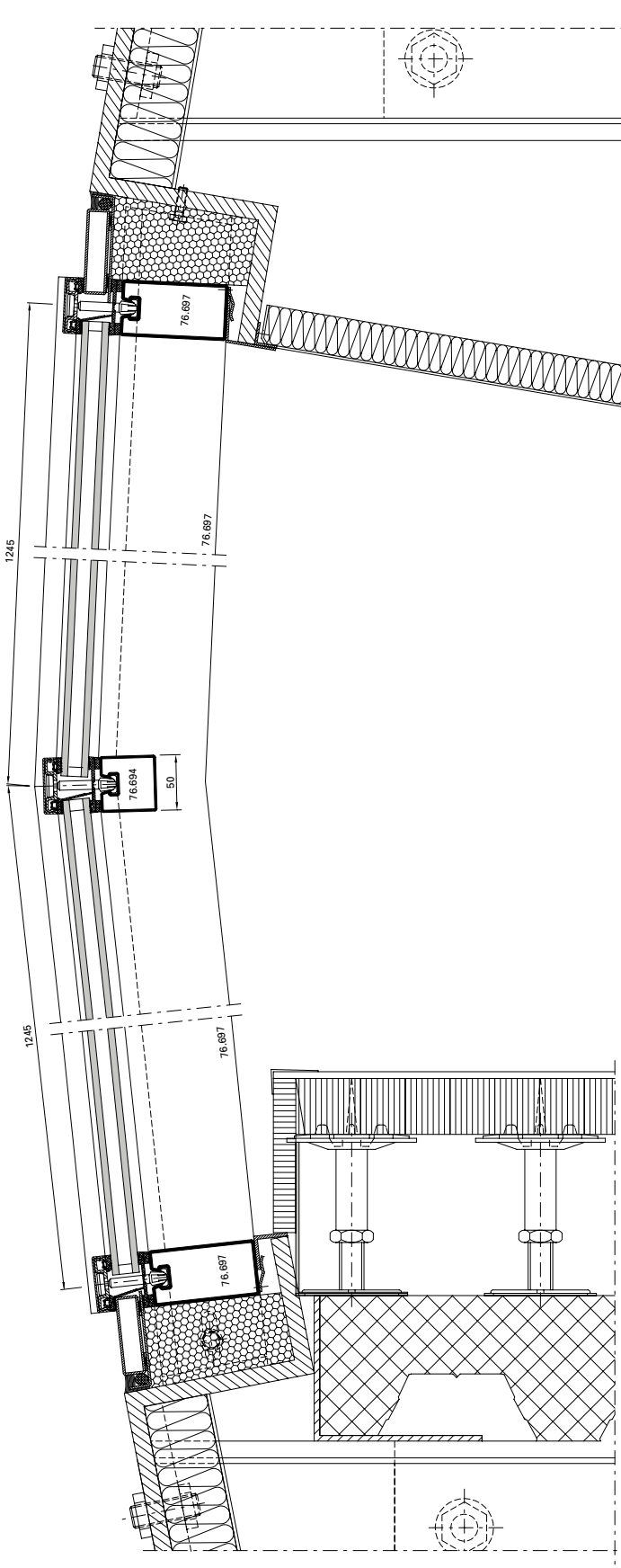

Ausgeführte Objekte

Objets réalisés

Completed projects

Objekt:

«Erasmus» Studenten-Pavillon,
Rotterdam/NL

System:

VISS I_xtra SG

Architekt:

Powerhouse Company &
DeZwarteHond, Rotterdam/NL

Objet:

Pavillon pour étudiants «Erasmus»,
Rotterdam/NL

Système:

VISS I_xtra SG

Architecte:

Powerhouse Company &
DeZwarteHond, Rotterdam/NL

Project:

«Erasmus» student pavilion,
Rotterdam/NL

System:

VISS I_xtra SG

Architect:

Powerhouse Company &
DeZwarteHond, Rotterdam/NL

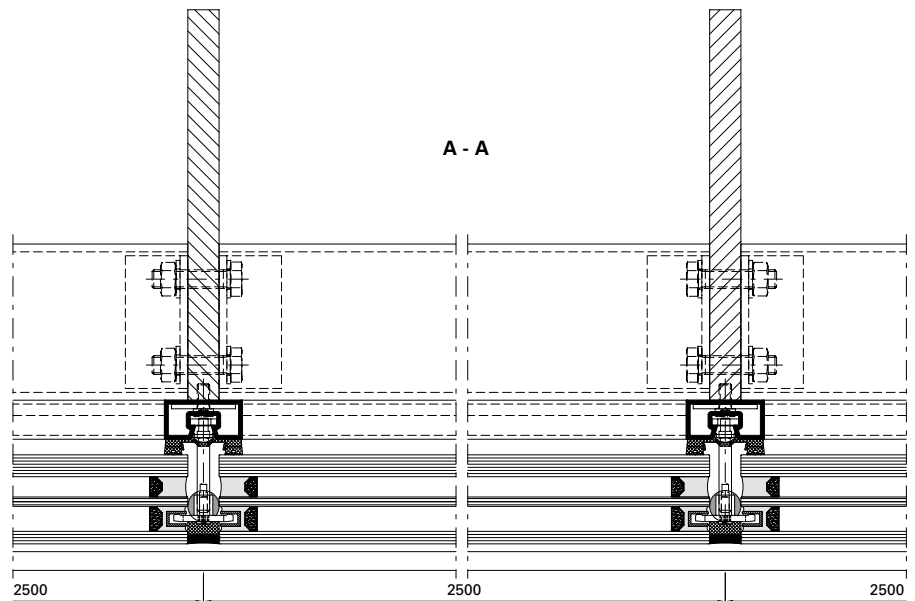

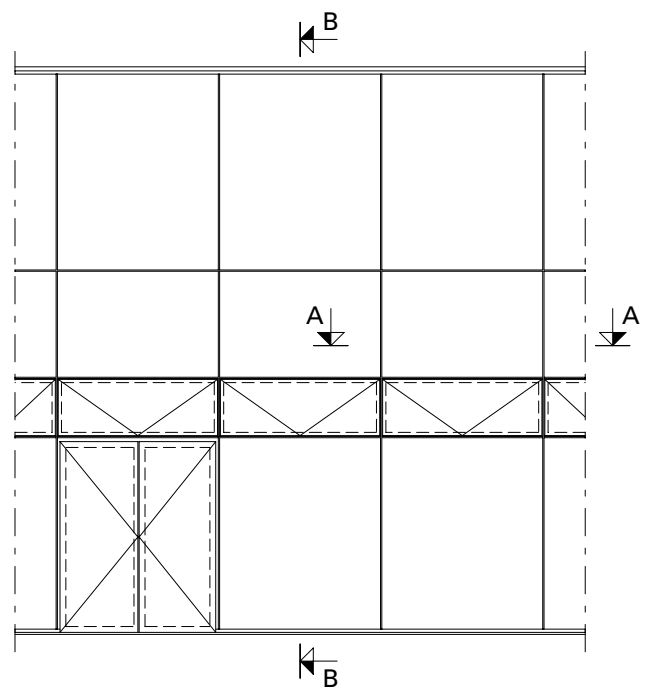
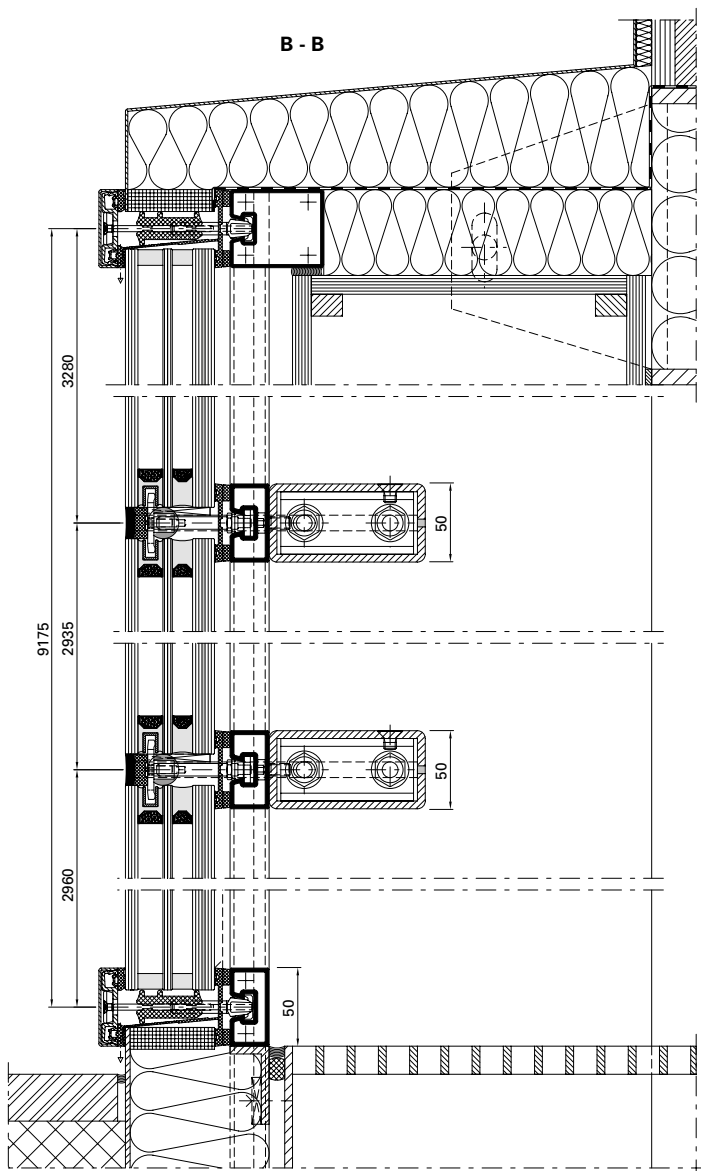

Ausgeführte Objekte
Objets réalisés
Completed projects



Fotos: Stephan Falk, Berlin

Objekt:

Hochschule «Anstalt für angewandte Wissenschaften», Dessau/DE

System:

VISS TVS

Architekt:

Kossel, Simon und Partner,
Magdeburg/DE

Objet:

École supérieure «Anstalt für angewandte Wissenschaften», Dessau/DE

Système:

VISS TVS

Architecte:

Kossel, Simon und Partner,
Magdeburg/DE

Project:

University «Anstalt für angewandte Wissenschaften», Dessau/DE

System:

VISS TVS

Architect:

Kossel, Simon und Partner,
Magdeburg/DE



Objekt:

Justizgebäude, Würzburg/DE

System:

VISS TVS, VISS Fire TVS (schräg)

Architekt:

Staatliches Bauamt Würzburg, Abt. L4, Würzburg/DE

Objet:

Palais de justice, Würzburg/DE

Système:

VISS TVS, VISS Fire TVS (oblique)

Architecte:

Staatliches Bauamt Würzburg, Abt. L4, Würzburg/DE

Project:

Law courts, Würzburg/DE

System:

VISS TVS, VISS Fire TVS (sloping)

Architect:

Staatliches Bauamt Würzburg, Abt. L4, Würzburg/DE



Fotos: Gerhard Hagen, Bamberg

Ausgeführte Objekte

Objets réalisés

Completed projects

Objekt:

Halle M, Jansen AG, Oberriet/CH

System:

VISS TVS HI

Architekt:

Göldi + Eggenberger AG,
Altstätten/CH

Objet:

Hall M, Jansen AG, Oberriet/CH

Système:

VISS TVS HI

Architecte:

Göldi + Eggenberger AG,
Altstätten/CH

Project:

Hall M, Jansen AG, Oberriet/CH

System:

VISS TVS HI

Architect:

Göldi + Eggenberger AG,
Altstätten/CH



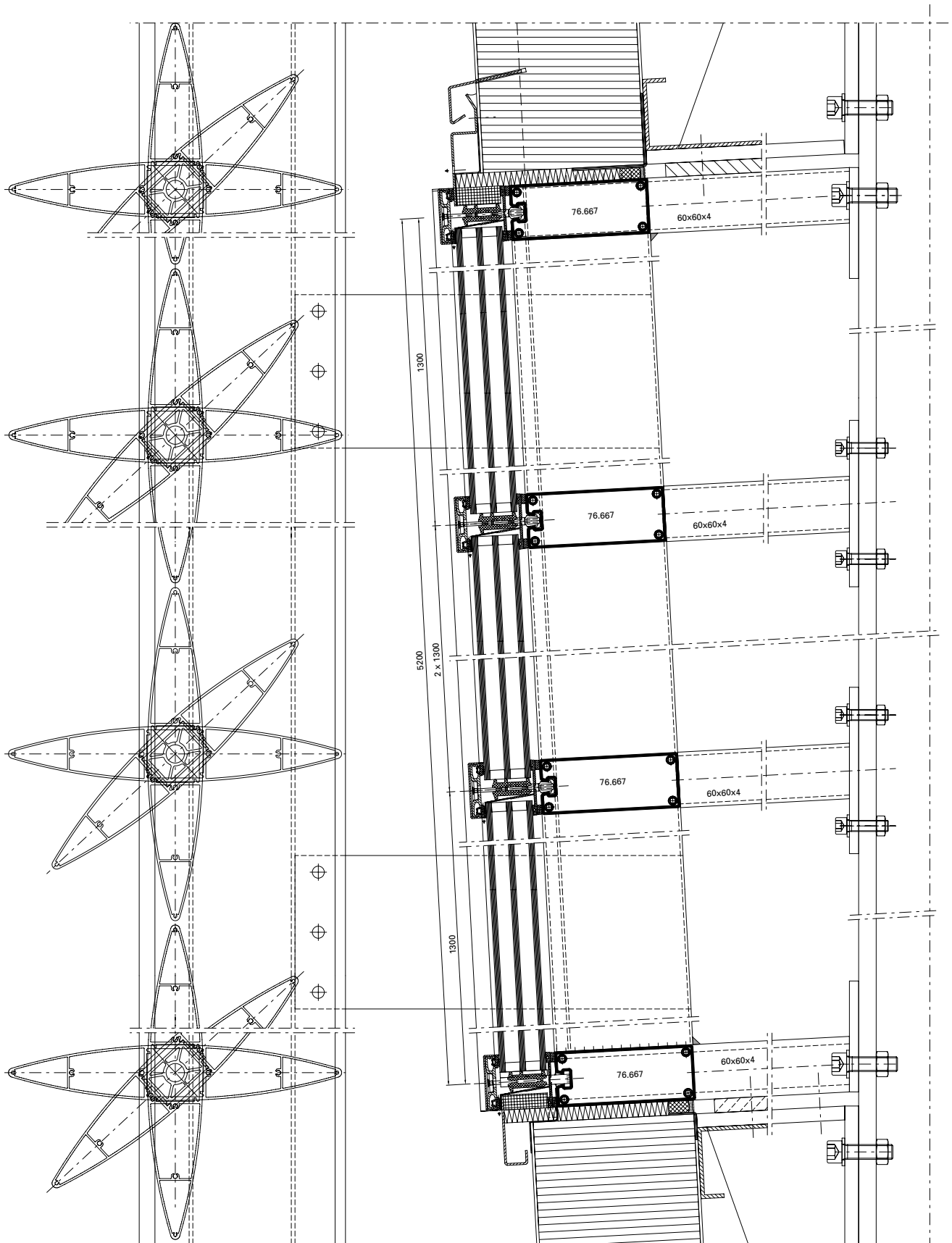

Ausgeführte Objekte
Objets réalisés
Completed projects



Fotos: Stephan Falk, Berlin

Objekt:

Vogtlandhalle (Stadthalle), Greiz/DE

System:

VISS TVS, Janisol Faltwand

Architekt:

Hoffmann.Seifert.Partner mit Ernst Scharf, Erfurt/DE

Objet:

Vogtlandhalle (salle municipale), Greiz/DE

Système:

VISS TVS, Janisol porte repliable

Architecte:

Hoffmann.Seifert.Partner mit Ernst Scharf, Erfurt/DE

Project:

Vogtland hall (city hall), Greiz/DE

System:

VISS TVS, Janisol folding wall

Architect:

Hoffmann.Seifert.Partner mit Ernst Scharf, Erfurt/DE

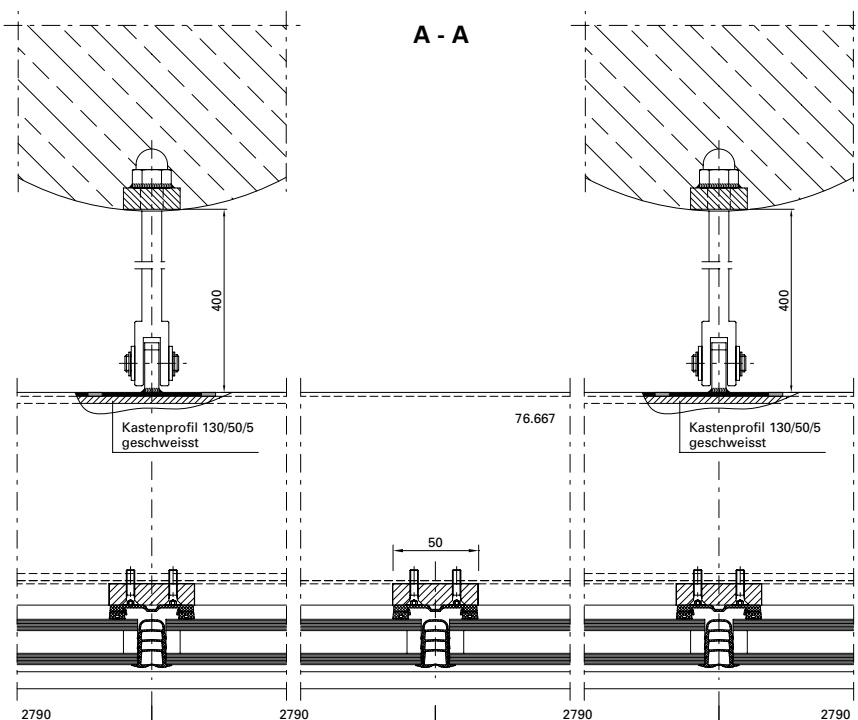

B - B

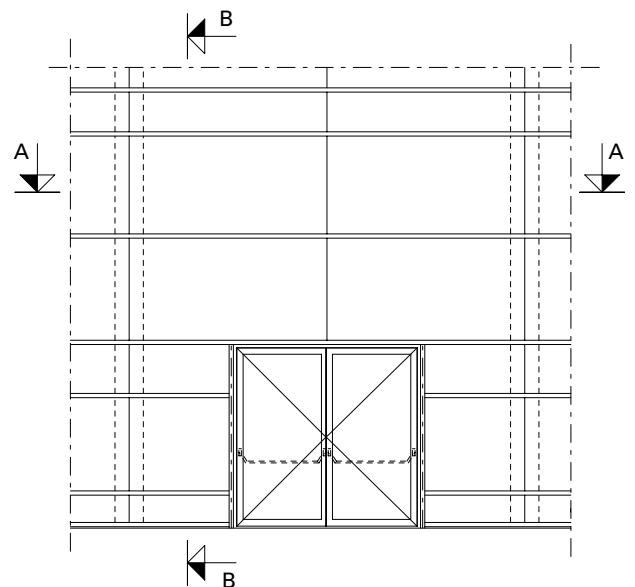
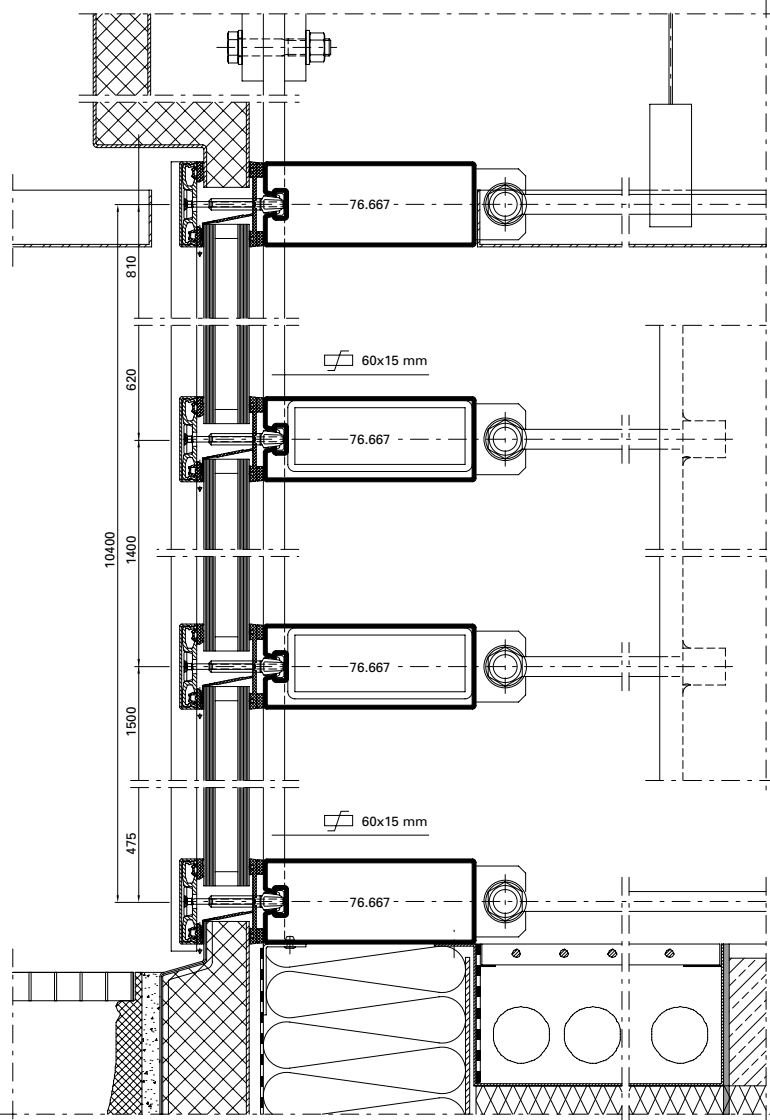

Ausgeführte Objekte

Objets réalisés

Completed projects

Objekt:

Ausbau Messehalle BEA Expo,
Bern/CH

System:

VISS Fire E30/EI30,
Jansen-Economy E30, Janisol 2 EI30

Architekt:

Schwaar & Partner AG, Bern/CH

Objet:

Agrandissement du hall d'exposition
BEA Expo, Berne/CH

Système:

VISS Fire E30/EI30,
Jansen-Economy E30, Janisol 2 EI30

Architecte:

Schwaar & Partner AG, Berne/CH

Project:

Exhibition hall extension BEA Expo,
Bern/CH

System:

VISS Fire E30/EI30,
Jansen-Economy E30, Janisol 2 EI30

Architect:

Schwaar & Partner AG, Bern/CH



Objekt:

MAN Nutzfahrzeuge, Werkserweiterung,
München/DE

System:

VISS I_xtra, Janisol Türen

Architekt:

DMP Architekten BDA, München/DE

Objet:

MAN Nutzfahrzeuge, agrandissement
de l'usine, Munich/DE

Système:

VISS I_xtra, portes Janisol

Architecte:

DMP Architekten BDA, Munich/DE

Project:

MAN Nutzfahrzeuge, plant extension,
Munich/DE

System:

VISS I_xtra, Janisol doors

Architect:

DMP Architekten BDA, Munich/DE



Ausgeführte Objekte Objets réalisés Completed projects

Objekt:

Museumsquartier, Den Bosch/NL

System:

VISS I_xtra TV

Architekt:

Bierman Henket Architecten, Esch/NL

Objet:

Quartier des musées, Den Bosch/NL

Système:

VISS I_xtra TV

Architecte:

Bierman Henket Architecten, Esch/NL

Project:

Museum Quarter, Den Bosch/NL

System:

VISS I_xtra TV

Architect:

Bierman Henket Architecten, Esch/NL



B - B

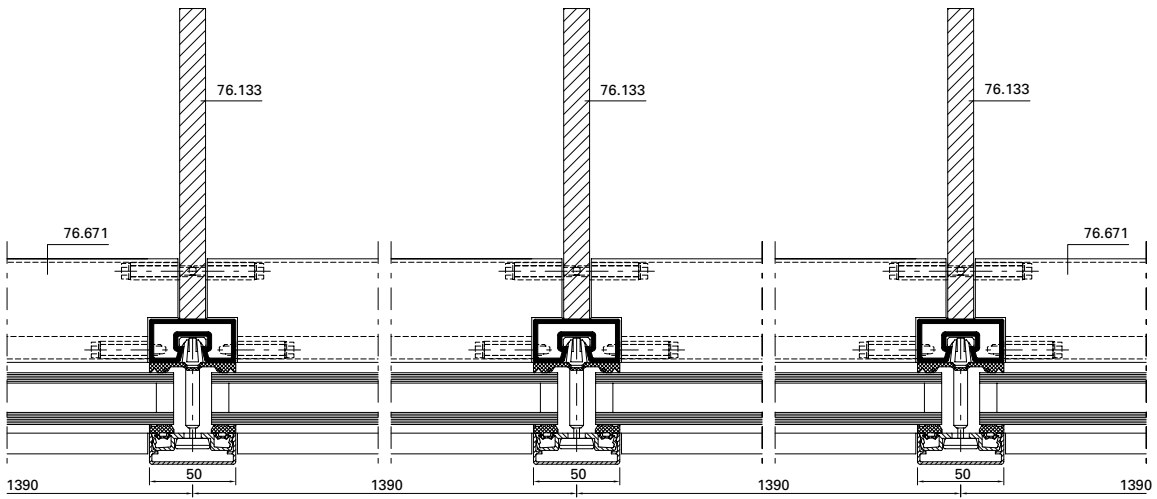

A - A

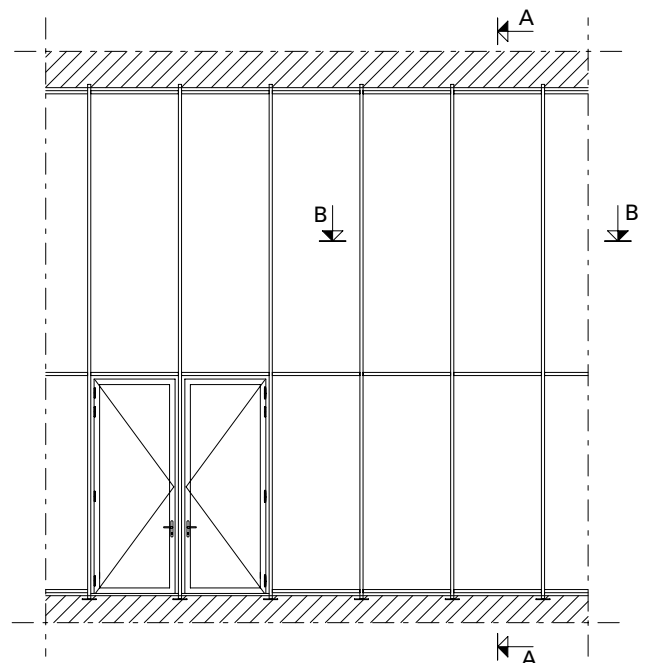
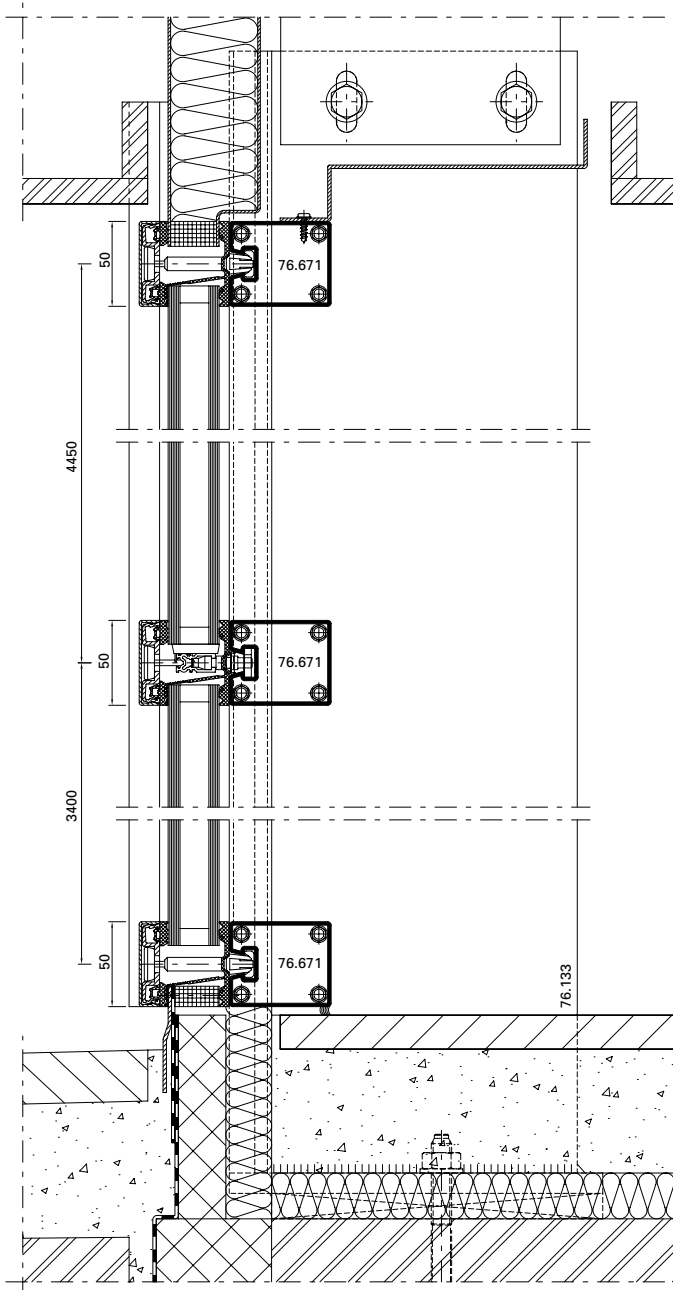

Ausgeführte Objekte Objets réalisés Completed projects

Objekt:

Werkhalle Glas Trösch,
St.Gallen/CH

System:

VISS TVS

Architekt:

Schuchter Ehle, Architekten, St.Gallen/
CH

Objet:

Atelier de Glas Trösch,
Saint-Gall/CH

Système:

VISS TVS

Architecte:

Schuchter Ehle, Architekten,
Saint-Gall/CH

Project:

Glas Trösch factory building,
St. Gallen/CH

System:

VISS TVS

Architect:

Schuchter Ehle, Architekten, St.Gallen/
CH





Objekt:

Voentorg Center,
Moskau/RU

System:

VISS TV, VISS Fire

Architekt:

Mosprojekt-2: Kolosnitsin Vladimir
Vasilyevich / Starikov Alexander
Fedorovich, Moskau/RU

Objet:

Centre Voentorg,
Moscou/RU

Système:

VISS TV, VISS Fire

Architecte:

Mosprojekt-2: Kolosnitsin Vladimir
Vasilyevich / Starikov Alexander
Fedorovich, Moscou/RU

Project:

Voentorg Center,
Moscow/RU

System:

VISS TV, VISS Fire

Architect:

Mosprojekt-2: Kolosnitsin Vladimir
Vasilyevich / Starikov Alexander
Fedorovich, Moscow/RU



Ausgeführte Objekte Objets réalisés Completed projects

Objekt:

Neue Messehalle
(Kielce Trade Fairs), Kielce/PL

System:

VISS TVS (vertikal und schräg),
Janisol 2 E130, Falttore

Architekt:

bsp Architekten: Barbara Średniawa,
Gliwice/PL

Objet:

Nouveau hall d'exposition
(Kielce Trade Fairs), Kielce/PL

Système:

VISS TVS (vertical et oblique),
Janisol 2 E130, Porte accordéon

Architecte:

bsp Architekten: Barbara Średniawa,
Gliwice/PL

Project:

New exhibition hall
(Kielce Trade Fairs), Kielce/PL

System:

VISS TVS (vertical and sloping),
Janisol 2 E130, Folding doors

Architect:

bsp Architekten: Barbara Średniawa,
Gliwice/PL



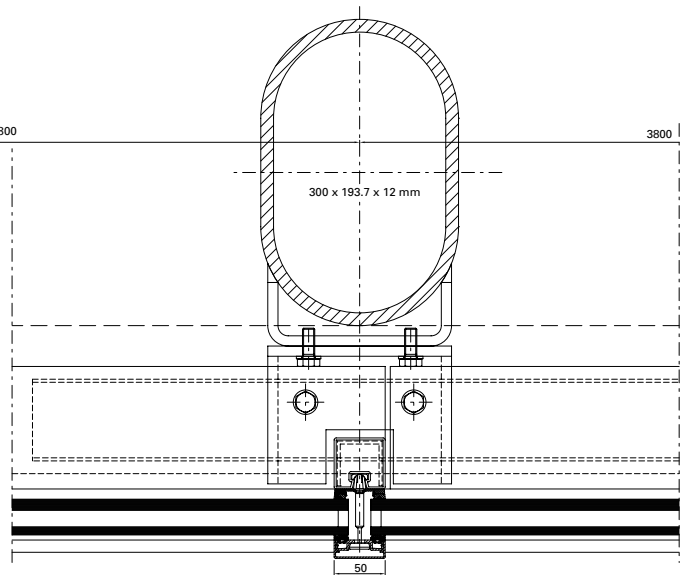
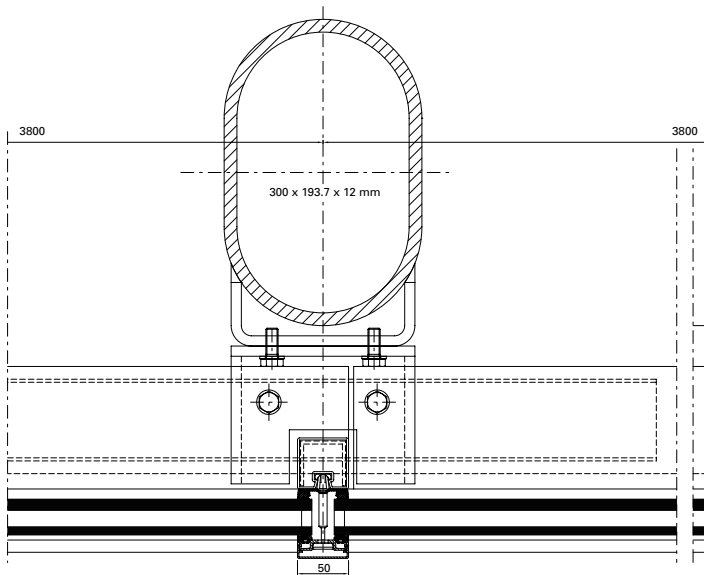
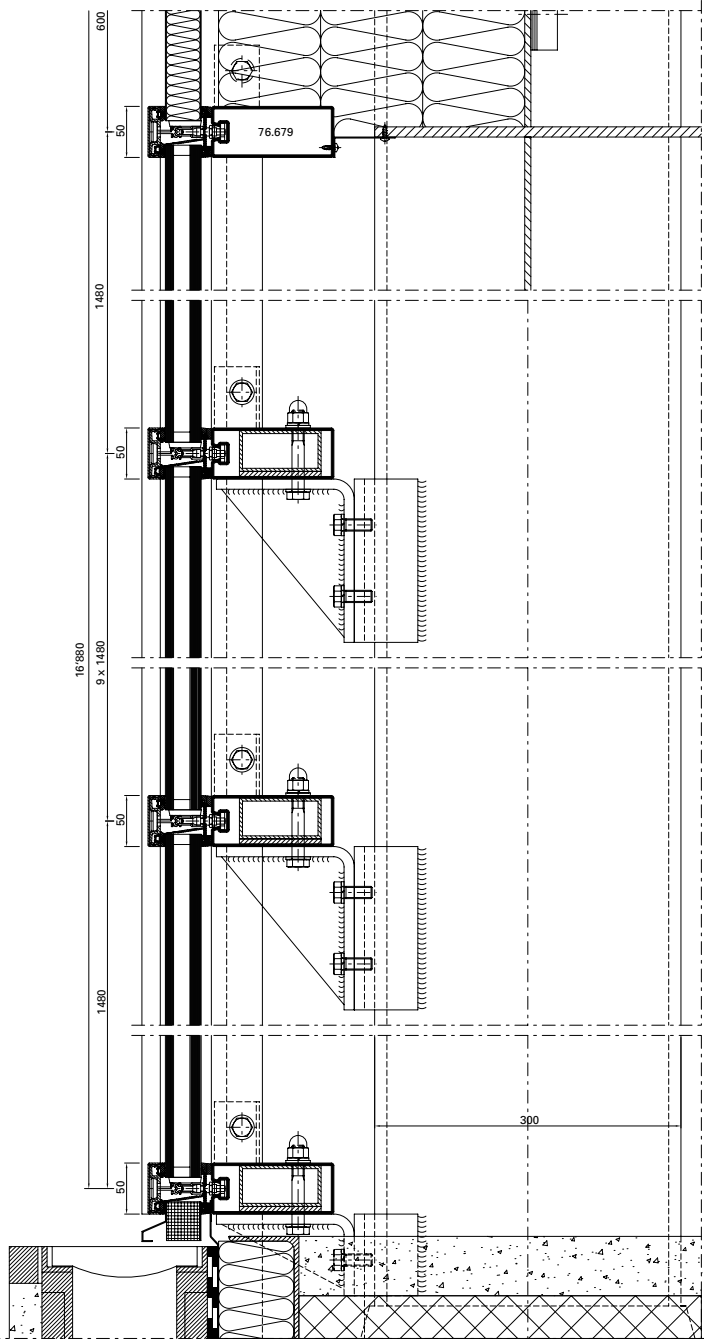

Inhaltsverzeichnis

Sommaire

Content



3 Wissenschafts-
zentrum Kopernikus,
Warschau/PL



4 Schloss Novy Svetlov,
Bojkovice/CZ



5 Hotel Magyar Király,
Székesfehérvár/HU



6 Theater- und
Konzerthaus Kilden,
Kristiansand/NO



8 Museum für
moderne Kunst,
Zagreb/HR



10 Museum für Kunst
und Kulturgeschichte
Altona,
Hamburg-Altona/DE



11 TransPort
(Flughafen Schiphol),
Amsterdam/NL



12 Büro- und
Geschäftshaus
«Hillsite»,
Schwalbach am
Taunus/DE



14 Zentralarchiv EDF,
Bure/FR



16 Gemeindehaus,
Ruidellots de la
Selva/ES



17 Hauptbahnhof,
Köln/DE



18 Universität
Lausanne
«Géopolis»,
Lausanne/CH



20 Jansen AG, Campus,
Oberriet/CH



22 Bildungsforum,
Potsdam/DE



24 Besucherzentrum
«Alte Wasserzentrale»,
Pietra Neamt/RO



26 Hotel Novi Spa,
Novi Vinodolski/HR



27 Solvias AG, Büro-
und Lagergebäude,
Kaiseraugst/CH



28 Médiathèque,
Pau/FR



30 «Mumuth» Haus
für Musik &
Musiktheater der
Kunstuniversität,
Graz/AT



32 Centre Pompidou,
Metz/FR



33 Alters- und
Pflegeheim,
Burgdorf/CH



34 Drents Museum,
Assen/NL



36 Akustik-Tunnels,
Warschau/PL



38 Jin Ji Hu
Kempinski Hotel,
Suzhou/CN



39 Historisches
Museum,
Kharkov/UA



40 Kunstgebäude,
Stuttgart/DE



42 3-Feldsporthalle,
Ingelfingen/DE



44 Musikkonservatorium,
Bilbao/ES



45 Landesberufsschule,
Mureck/AT



46 Hafencity Schule,
Hamburg/DE



48 Drehrestaurant
«Hoher Kasten»,
Brülisau/CH



50 Hauptbahnhof
«Rotterdam Centraal»,
Rotterdam/NL



52 IGuzzini
Illuminazione,
Barcelona/ES



54 «Erasmus»
Studenten-Pavillon,
Rotterdam/NL



56 Hochschule
«Anstalt für
angewandte
Wissenschaften»,
Dessau/DE



57 Justizgebäude,
Würzburg/DE



58 Halle M, Jansen AG,
Oberriet/CH



60 Vogtlandhalle
(Stadthalle),
Greiz/DE



62 Ausbau Messehalle
BEA Expo,
Bern/CH



63 MAN Nutzfahrzeuge,
Werkserweiterung,
München/DE



64 Museumsquartier,
Den Bosch/NL



66 Werkhalle
Glas Trösch,
St.Gallen/CH



67 Voentorg Center,
Moskau/R



68 Neue Messehalle
(Kielce Trade Fairs),
Kielce/PL

Ausgeführte Objekte
Objets réalisés
Completed projects

Objekt:

Wissenschaftszentrum Kopernikus,
Centrum Nauki Kopernik, Warschau/PL

System:

VISS TVS, VISS SG, VISS Fire,
Janisol 2 EI30, Janisol SG

Architekt:

RAR-2 Laboratorium Architektury
Jan Kubec, Ruda Śląska/PL

Objet:

Centre de recherche Copernique,
Centrum Nauki Kopernik, Varsovie/PL

Système:

VISS TVS, VISS SG, VISS Fire,
Janisol 2 EI30, Janisol SG

Architecte:

RAR-2 Laboratorium Architektury
Jan Kubec, Ruda Śląska/PL

Project:

Copernicus Science Centre,
Centrum Nauki Kopernik, Warsaw/PL

System:

VISS TVS, VISS SG, VISS Fire,
Janisol 2 EI30, Janisol SG

Architect:

RAR-2 Laboratorium Architektury
Jan Kubec, Ruda Śląska/PL



Ausgeführte Objekte
Objets réalisés
Completed projects



Objekt:

Schloss Novy Svetlov, Bojkovice/CZ

System:

VISS SG, VISS TVS (schräg)

Architekt:

Stavos s.r.o., Příbram/CZ

Objet:

Château Novy Svetlov, Bojkovice/CZ

Système:

VISS SG, VISS TVS (oblique)

Architecte:

Stavos s.r.o., Příbram/CZ

Project:

Novy Svetlov castle, Bojkovice/CZ

System:

VISS SG, VISS TVS (sloping)

Architect:

Stavos s.r.o., Příbram/CZ



Objekt:

Hotel Magyar Király,
Székesfehérvár/HU

System:

VISS TVS (schräg)

Architekt:

Szendro Epitesz Studio, Budapest/HU

Objet:

Hôtel Magyar Király,
Székesfehérvár/HU

Système:

VISS TVS (oblique)

Architecte:

Szendro Epitesz Studio, Budapest/HU

Project:

Hotel Magyar Király, Székesfehérvár/
HU

System:

VISS TVS (sloping)

Architect:

Szendro Epitesz Studio, Budapest/HU

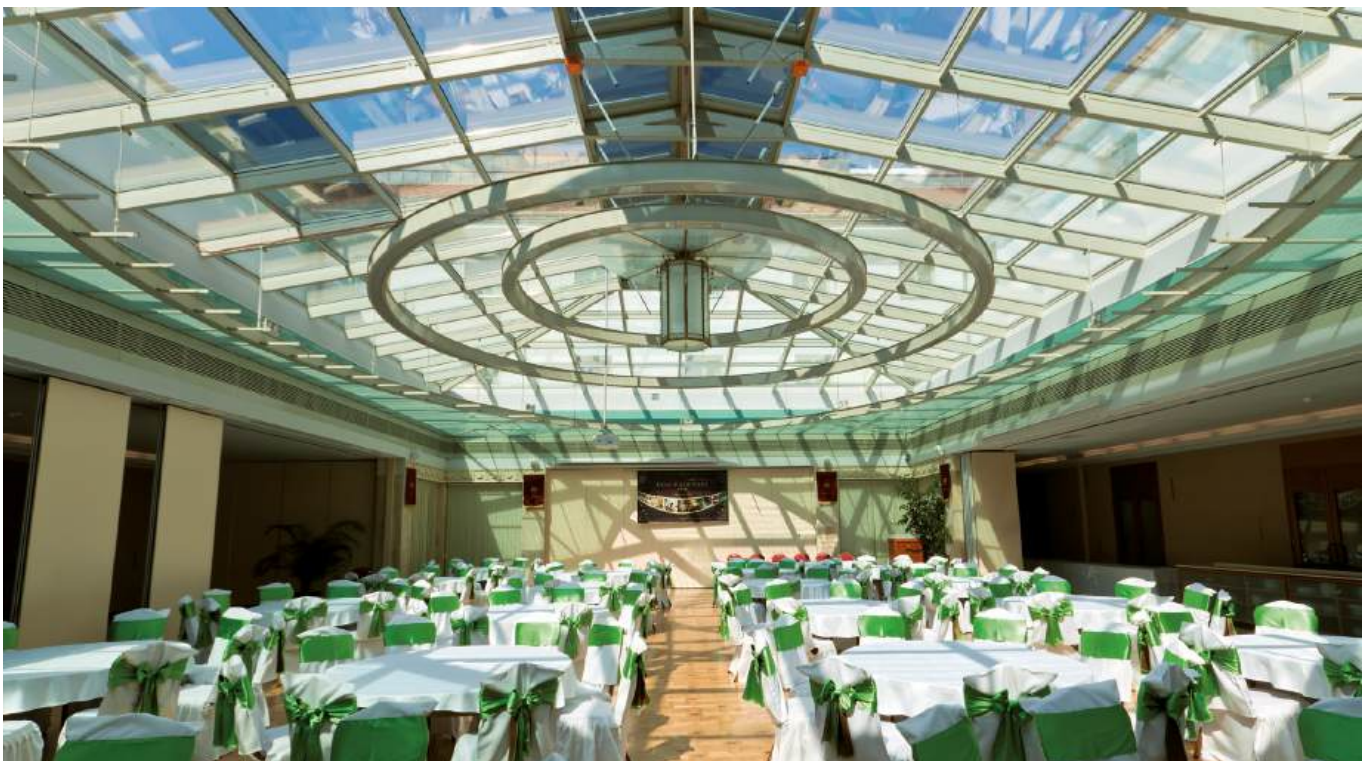

Ausgeführte Objekte

Objets réalisés

Completed projects

Objekt:

Theater- und Konzerthaus Kilden,
Kristiansand/NO

System:

VISS I_xtra

Architekt:

ALA Architects, Helsinki/SF

Objet:

Maison du théâtre et des concerts
Kilden, Kristiansand/NO

Système:

VISS I_xtra

Architecte:

ALA Architects, Helsinki/SF

Project:

Kilden Performing Arts Centre,
Kristiansand/NO

System:

VISS I_xtra

Architect:

ALA Architects, Helsinki/SF



Fotos: Jiri Havran, Oslo

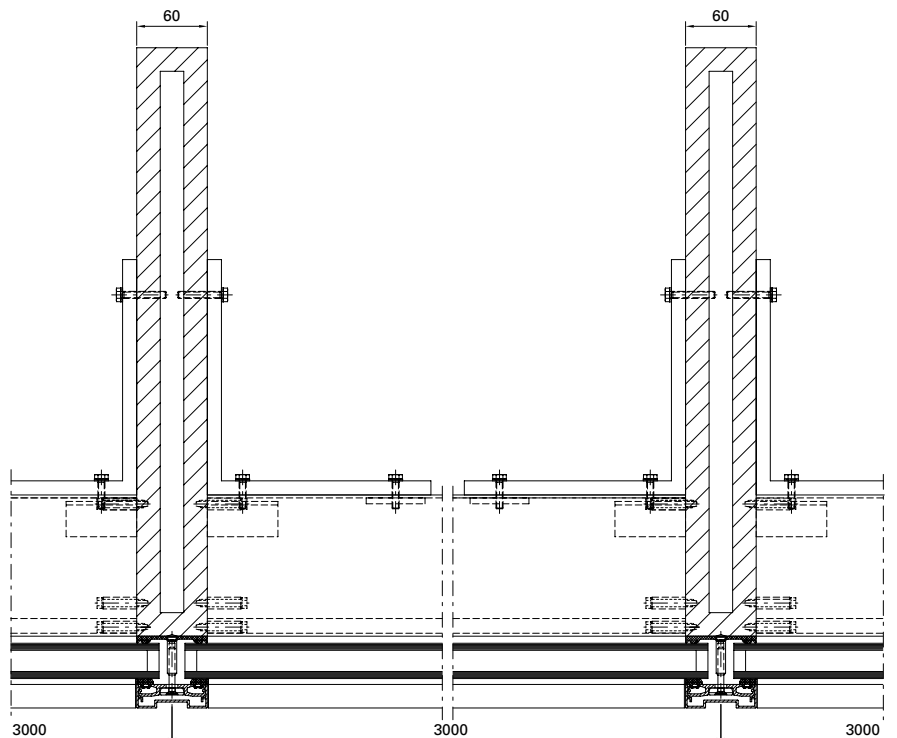
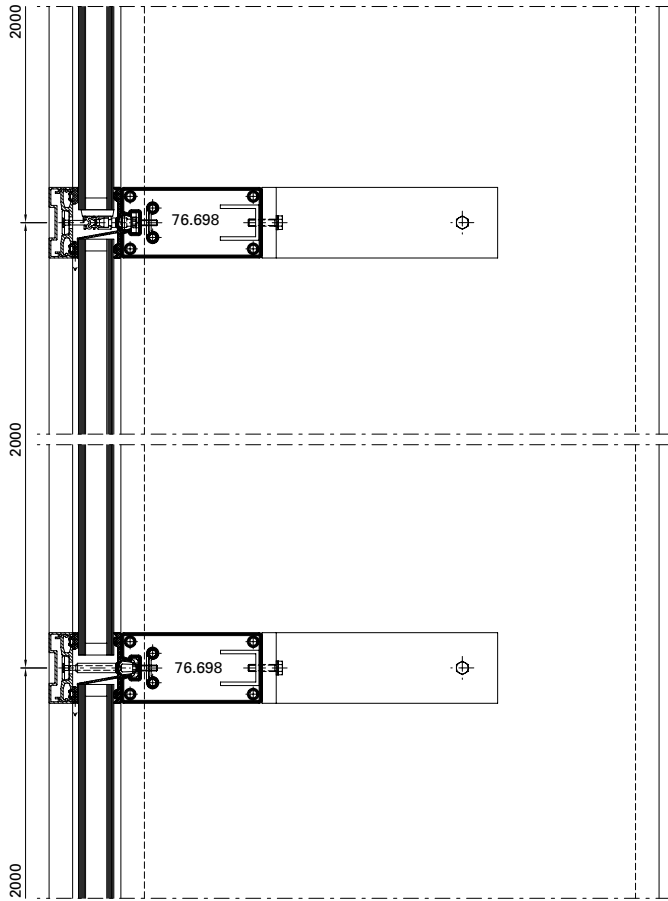

Ausgeführte Objekte

Objets réalisés

Completed projects

Objekt:

Museum für moderne Kunst, Zagreb/
HR

System:

VISS SG

Architekt:

Igor Franić Architekturstudio SZA,
Zagreb/HR

Objet:

Musée de l'art contemporain,
Zagreb/HR

Système:

VISS SG

Architecte:

Igor Franić Architekturstudio SZA,
Zagreb/HR

Project:

Museum of Contemporary Art, Zagreb/
HR

System:

VISS SG

Architect:

Igor Franić Architekturstudio SZA,
Zagreb/HR





Ausgeführte Objekte
Objets réalisés
Completed projects



Objekt:

Museum für Kunst und
Kulturgeschichte Altona,
Hamburg-Altona/DE

System:

VISS I_xtra, Janisol 2 EI30

Architekt:

Störmer Murphy and Partners GbR,
Hamburg/DE

Objet:

Musée de l'art et de l'histoire
de la civilisation Altona,
Hambourg-Altona/DE

Système:

VISS I_xtra, Janisol 2 EI30

Architecte:

Störmer Murphy and Partners GbR,
Hambourg/DE

Project:

Altona Museum of Art and
Cultural History Altona,
Hamburg-Altona/DE

System:

VISS I_xtra, Janisol 2 EI30

Architect:

Störmer Murphy and Partners GbR,
Hamburg/DE



Fotos: Jochen Helle, Dortmund

Objekt:

TransPort (Flughafen Schiphol),
Amsterdam/NL

System:

VISS Basic TVS Fire, VISS TVS

Architekt:

Architectenbureau Paul de Ruiter,
Amsterdam/NL

Objet:

TransPort (aéroport Schiphol),
Amsterdam/NL

Système:

VISS Basic TVS Fire, VISS TVS

Architecte:

Architectenbureau Paul de Ruiter,
Amsterdam/NL

Project:

TransPort (Schiphol airport),
Amsterdam/NL

System:

VISS Basic TVS Fire, VISS TVS

Architect:

Architectenbureau Paul de Ruiter,
Amsterdam/NL



Fotos. Pieter Kers/NL

Ausgeführte Objekte

Objets réalisés

Completed projects

Objekt:

Büro- und Geschäftshaus «Hillsite»,
Schwalbach am Taunus/DE

System:

VISS Semi SG

Architekt:

Meixner-Schlüter-Wendt Architekten,
Frankfurt am Main/DE

Objet:

Immeuble de bureaux et de commerce
«Hillsite», Schwalbach am Taunus/DE

Système:

VISS Semi SG

Architecte:

Meixner-Schlüter-Wendt Architekten,
Frankfurt am Main/DE

Project:

«Hillsite» office complex,
Schwalbach am Taunus/DE

System:

VISS Semi SG

Architect:

Meixner-Schlüter-Wendt Architekten,
Frankfurt am Main/DE

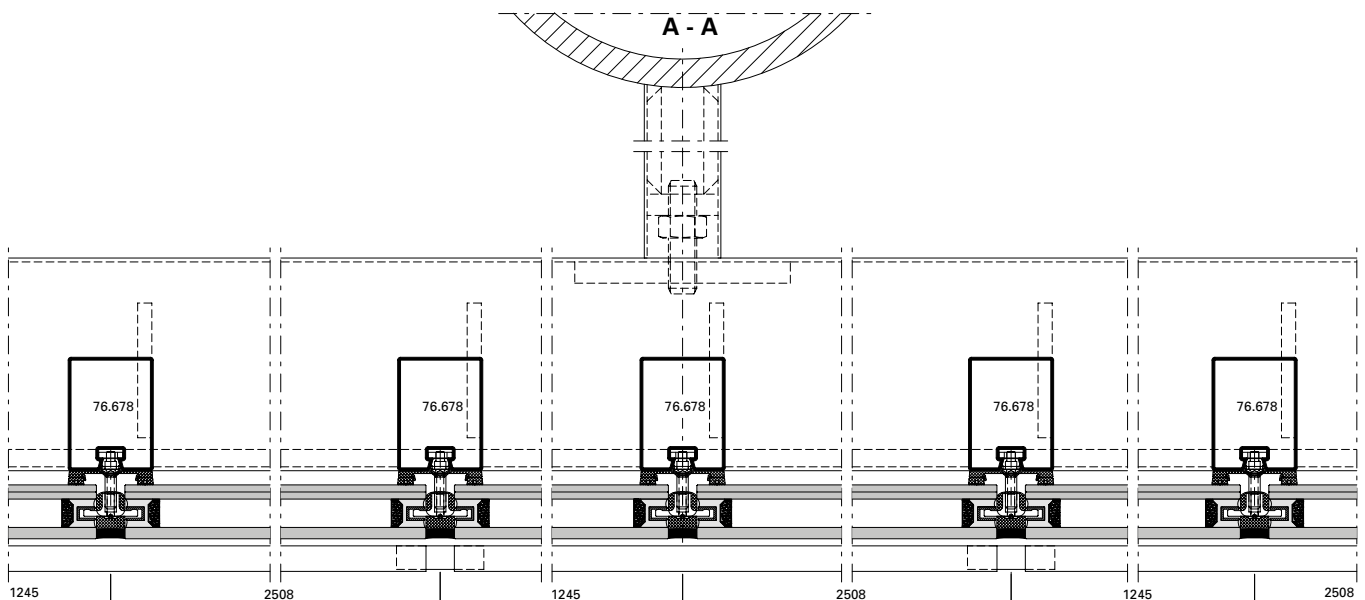

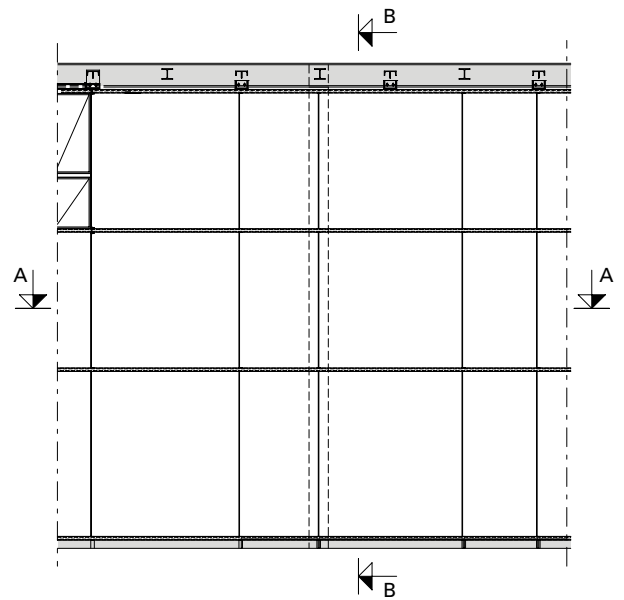
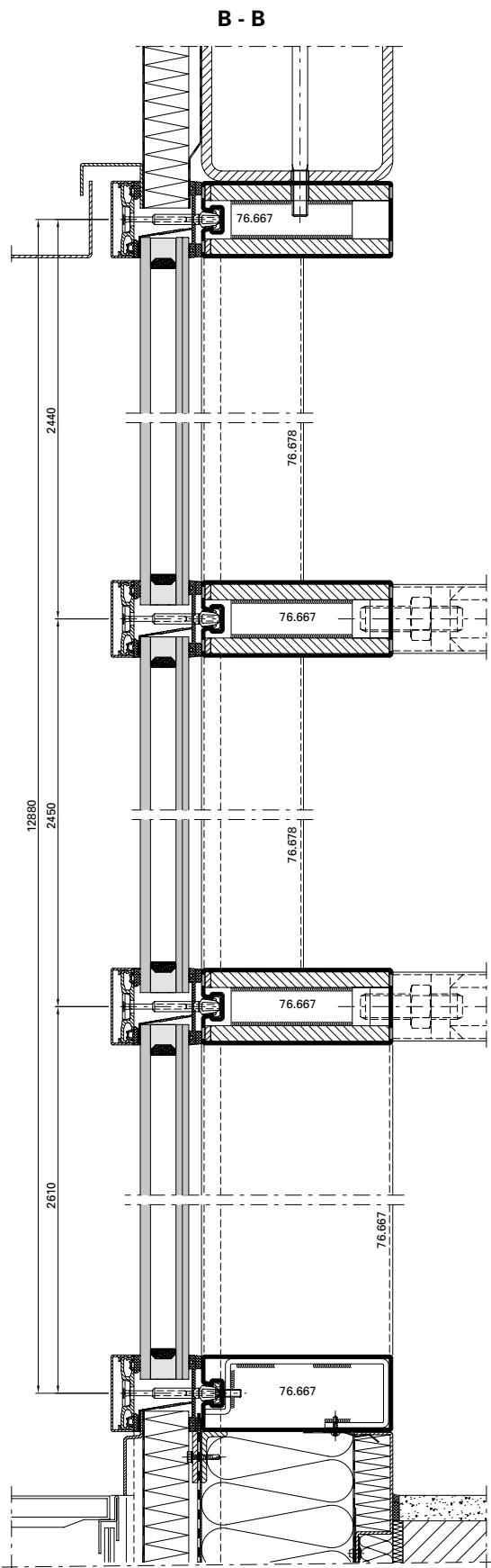

Ausgeführte Objekte Objets réalisés Completed projects

Objekt:

Zentralarchiv EDF, Bure/FR

System:

VISS TVS, Janisol Türen Edelstahl

Architekt:

LAN (Local Architecture Network),
Paris/FR

Objet:

Centre d'archives EDF, Bure/FR

Système:

VISS TVS, portes Janisol acier Inox

Architecte:

LAN (Local Architecture Network), Paris/
FR

Project:

Central archive EDF, Bure/FR

System:

VISS TVS, Janisol doors stainless steel

Architect:

LAN (Local Architecture Network),
Paris/FR

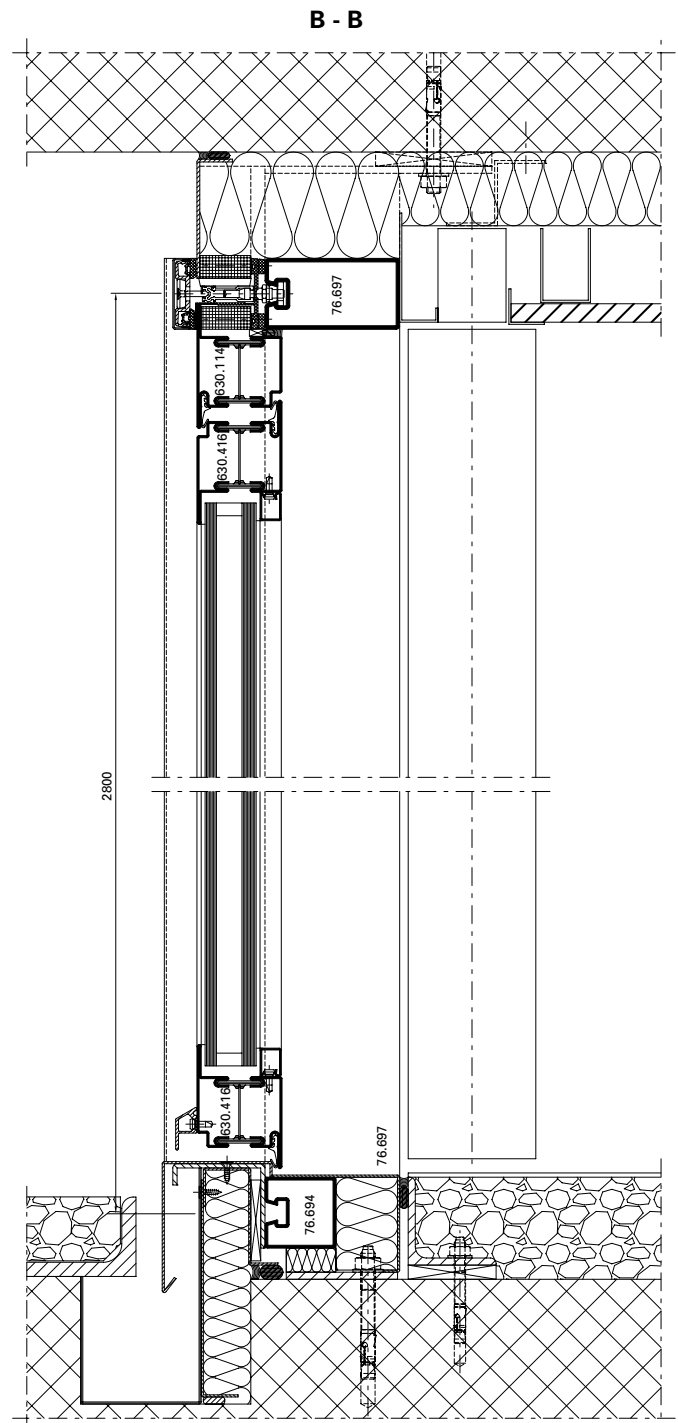

A - A

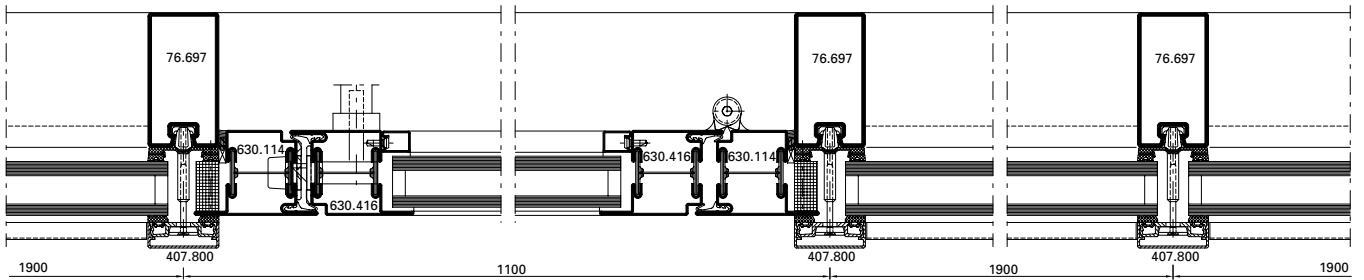

B

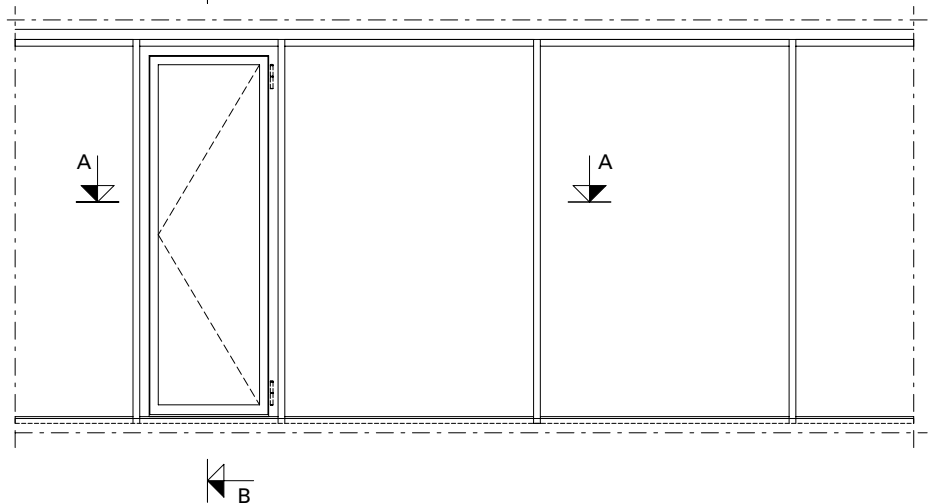

Ausgeführte Objekte

Objets réalisés

Completed projects

Objekt:

Gemeindehaus,
Ruidellots de la Selva/ES

System:

VISS TVS

Architekt:

Pla & Padrosa S.A., Girona/ES

Objet:

Hôtel de ville,
Ruidellots de la Selva/ES

Système:

VISS TVS

Architecte:

Pla & Padrosa S.A., Girona/ES

Project:

Town hall,
Ruidellots de la Selva/ES

System:

VISS TVS

Architect:

Pla & Padrosa S.A., Girona/ES

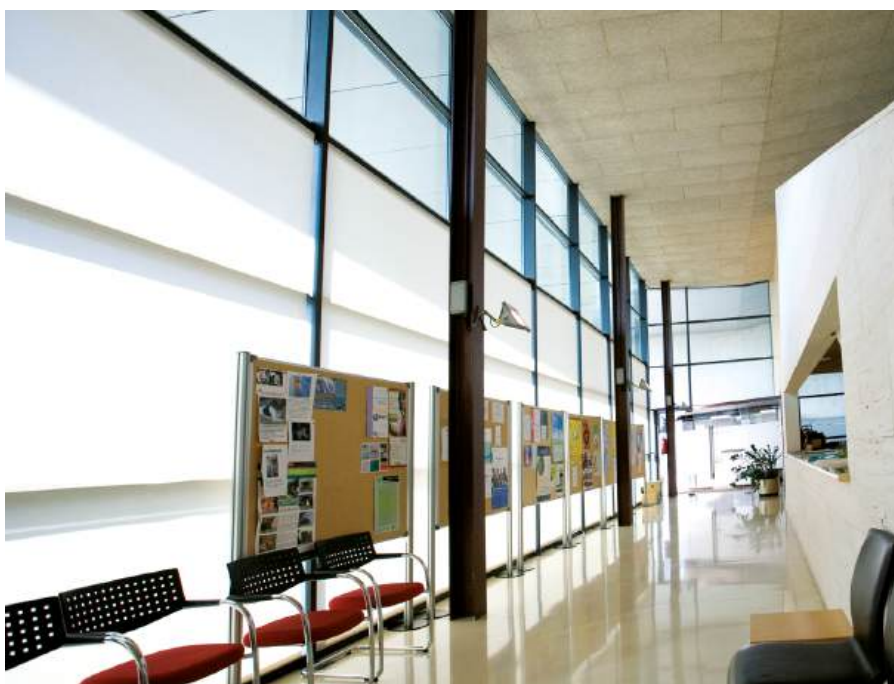

Objekt:

Hauptbahnhof, Köln/DE

System:

VISS TV, Jansen-Economy 50 Türen,
Janisol Türen Edelstahl

Architekt:

Kopka und Theil Architekten,
Dortmund/DE

Objet:

Gare centrale, Cologne/DE

Système:

VISS TV, portes Jansen-Economy 50,
portes Janisol acier Inox

Architecte:

Kopka und Theil Architekten,
Dortmund/DE

Project:

Central station, Cologne/DE

System:

VISS TV, Jansen-Economy 50 doors,
Janisol stainless steel doors

Architect:

Kopka und Theil Architekten,
Dortmund/DE



Fotos: Jochen Helle, Dortmund



Ausgeführte Objekte Objets réalisés Completed projects

Objekt:

UNIL, Universität Lausanne «Géopolis»,
Lausanne/CH

System:

VISS Fire, VISS TV, Janisol 2 EI30

Architekt:

Itten + Brechbühl Architekten,
Büro Lausanne, Lausanne/CH

Objet:

UNIL, Université de Lausanne
«Géopolis», Lausanne/CH

Système:

VISS Fire, VISS TV, Janisol 2 EI30

Architecte:

Itten + Brechbühl Architekten,
Büro Lausanne, Lausanne/CH

Project:

UNIL, University of Lausanne
«Géopolis», Lausanne/CH

System:

VISS Fire, VISS TV, Janisol 2 EI30

Architect:

Itten + Brechbühl Architekten,
Büro Lausanne, Lausanne/CH

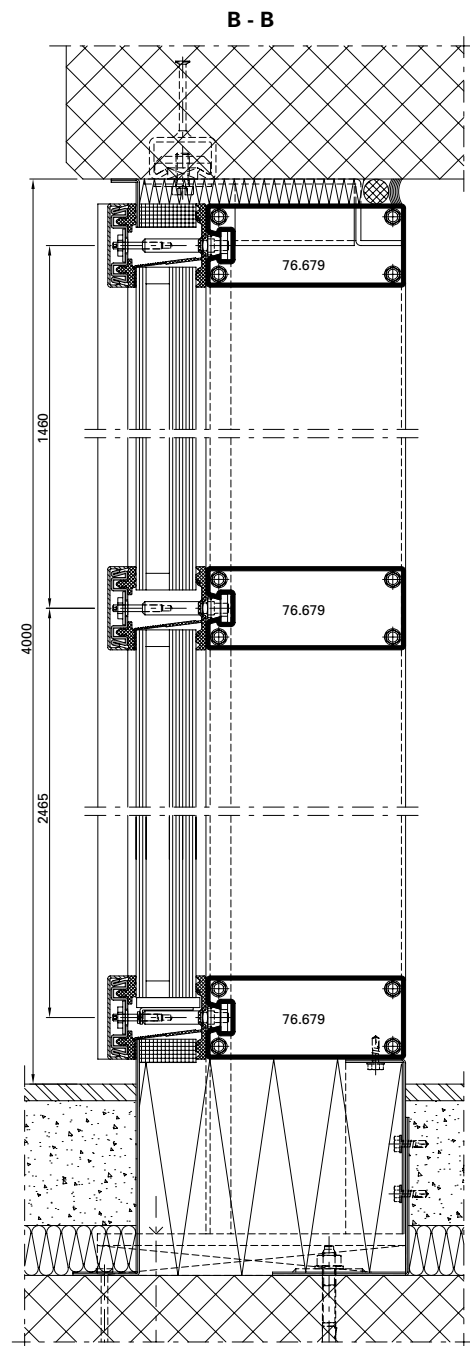

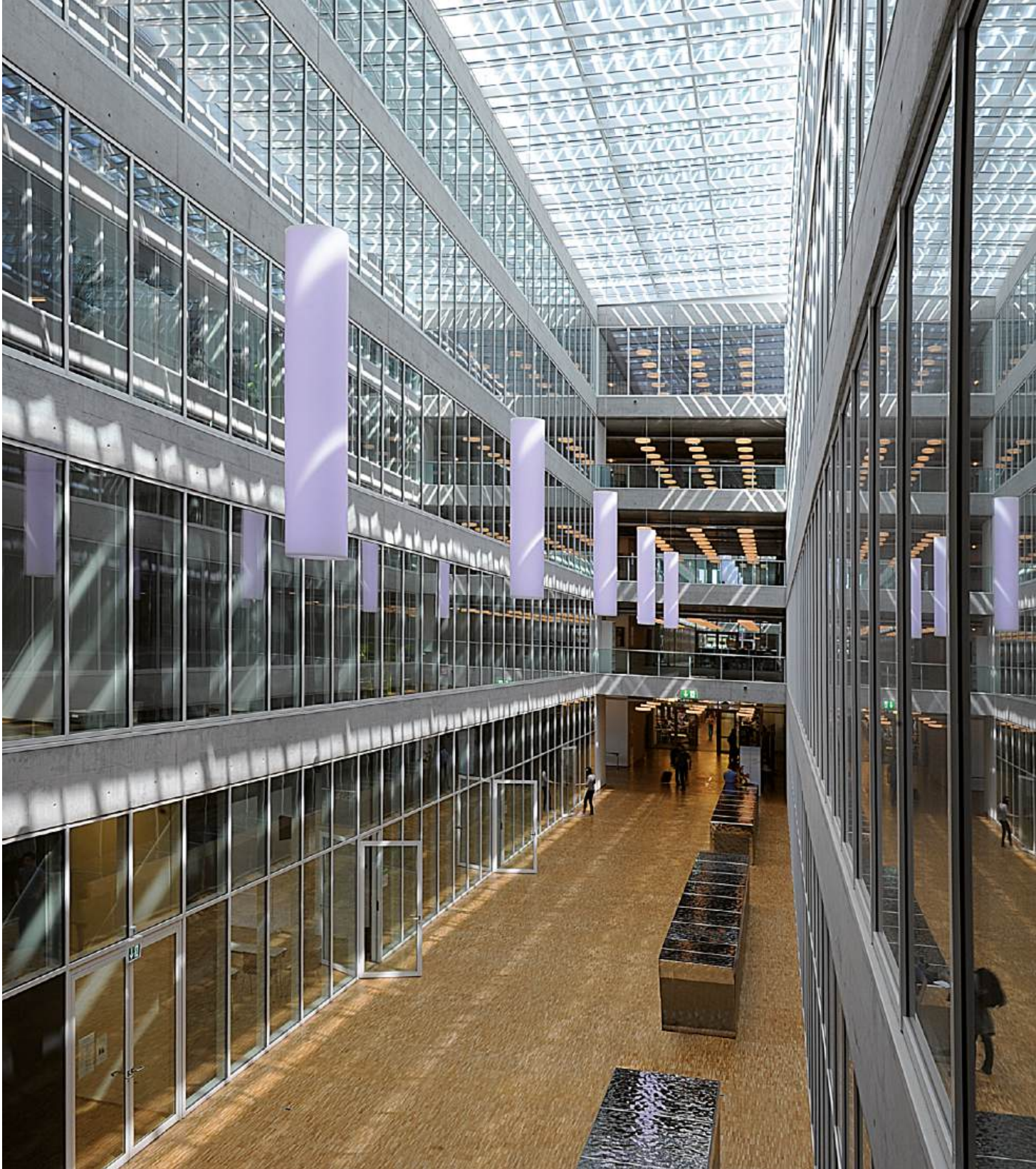

A - A

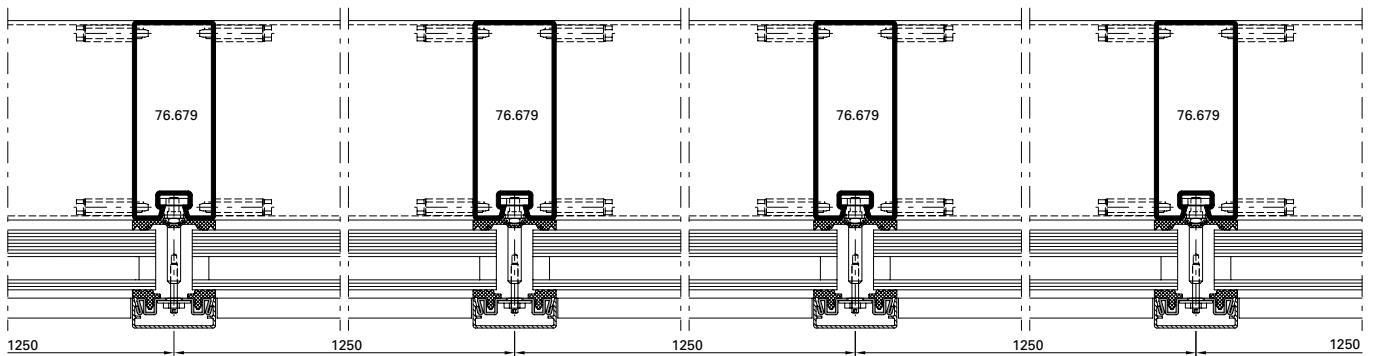

Ausgeführte Objekte

Objets réalisés

Completed projects

Objekt:

Jansen AG, Campus, Oberriet/CH

System:

VISS SG

Architekt:

Davide Macullo Architects, Lugano/CH

Objet:

Jansen AG, Campus, Oberriet/CH

Système:

VISS SG

Architecte:

Davide Macullo Architects, Lugano/CH

Project:

Jansen AG, Campus, Oberriet/CH

System:

VISS SG

Architect:

Davide Macullo Architects, Lugano/CH

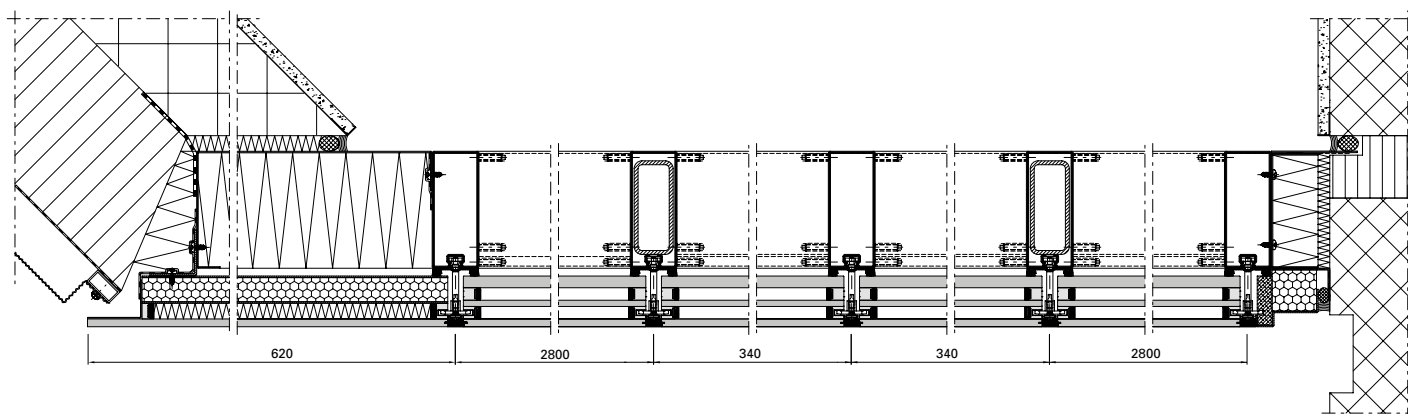

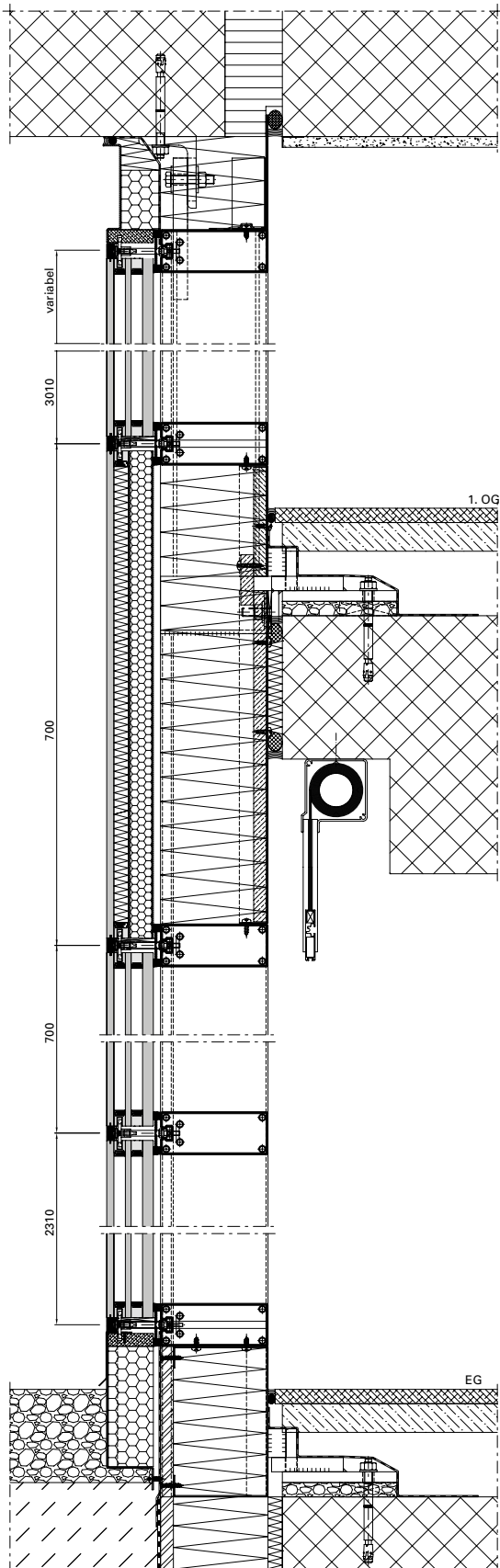

Ausgeführte Objekte

Objets réalisés

Completed projects

Objekt:

Bildungsforum, Potsdam/DE

System:

VISS TVS HI, VISS Fire

Architekt:

Reiner Becker Architekten BDA, Berlin/
DE

Objet:

Forum de formation, Potsdam/DE

Système:

VISS TVS HI, VISS Fire

Architecte:

Reiner Becker Architekten BDA, Berlin/
DE

Project:

Education forum, Potsdam/DE

System:

VISS TVS HI, VISS Fire

Architect:

Reiner Becker Architekten BDA, Berlin/
DE





Fotos: Stephan Falk, Berlin



Ausgeführte Objekte

Objets réalisés

Completed projects

Objekt:

Besucherzentrum «Alte Wasserzentrale», Pietra Neamt/RO

System:

VISS TVS

Architekt:

ZIP & BDX Studio, Marius Calin, Bukarest/RO

Objet:

Centre de visiteurs «ancienne centrale des eaux», Pietra Neamt/RO

Système:

VISS TVS

Architecte:

ZIP & BDX Studio, Marius Calin, Bukarest/RO

Project:

Visitor centre «old water station», Pietra Neamt/RO

System:

VISS TVS

Architect:

ZIP & BDX Studio, Marius Calin, Bukarest/RO

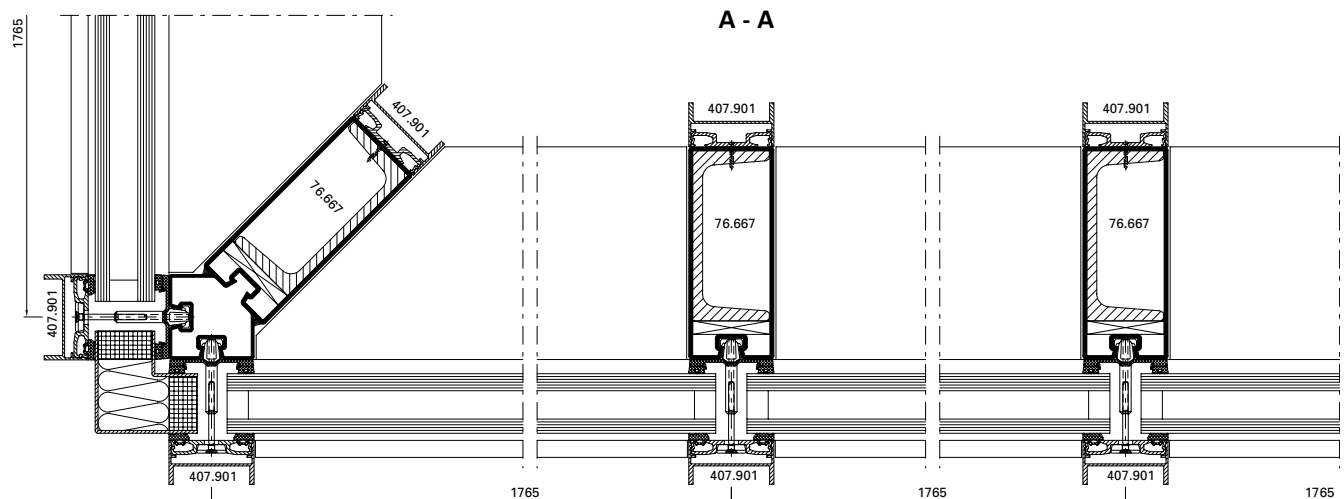

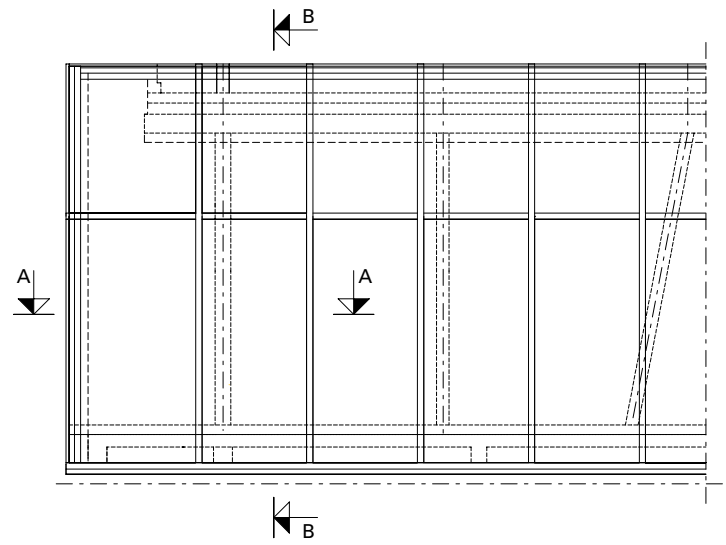
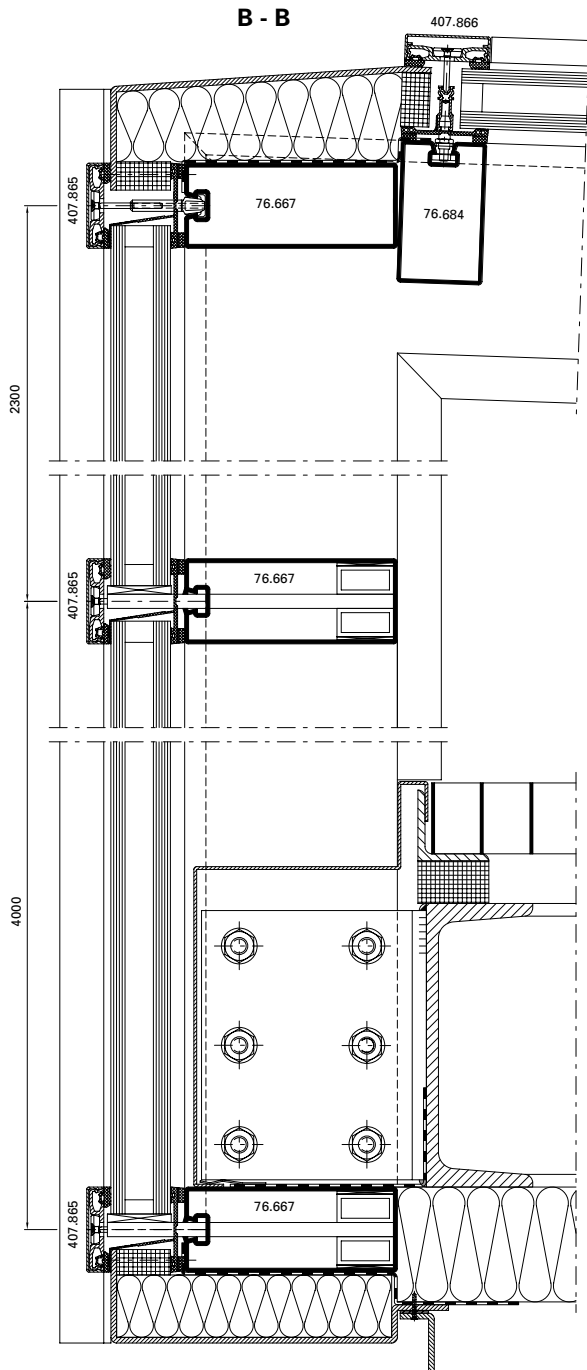

Ausgeführte Objekte

Objets réalisés

Completed projects

Objekt:

Hotel Novi Spa,
Novi Vinodolski/HR

System:

VISS TV Linea

Architekt:

Architekturstudio Banas und Cimas,
Rijeka/HR

Objet:

Hôtel Novi Spa,
Novi Vinodolski/HR

Système:

VISS TV Linea

Architecte:

Architekturstudio Banas und Cimas,
Rijeka/HR

Project:

Novi Spa Hotel,
Novi Vinodolski/HR

System:

VISS TV Linea

Architect:

Architekturstudio Banas und Cimas,
Rijeka/HR



Objekt:

Solvias AG, Büro- und Lagergebäude, Kaiseraugst/CH

System:

VISS TV Linea

Architekt:

Zwimpfer Partner Architekten, Basel/CH

Objet:

Solvias AG, immeuble de bureaux et d'entrepôt, Kaiseraugst/CH

Système:

VISS TV Linea

Architecte:

Zwimpfer Partner Architekten, Bâle/CH

Project:

Solvias AG, office and warehouse facility, Kaiseraugst/CH

System:

VISS TV Linea

Architect:

Zwimpfer Partner Architekten, Basle/CH



Ausgeführte Objekte

Objets réalisés

Completed projects

Objekt:

Médiathèque, Pau/FR

System:

VISS Fire EW60, VISS Basic,
Janisol 3 E160

Architekt:

CANAL, Paris/FR

Objet:

Médiathèque, Pau/FR

Système:

VISS Fire EW60, VISS Basic,
Janisol 3 E160

Architecte:

CANAL, Paris/FR

Project:

Médiathèque, Pau/FR

System:

VISS Fire EW60, VISS Basic,
Janisol 3 E160

Architect:

CANAL, Paris/FR



A - A

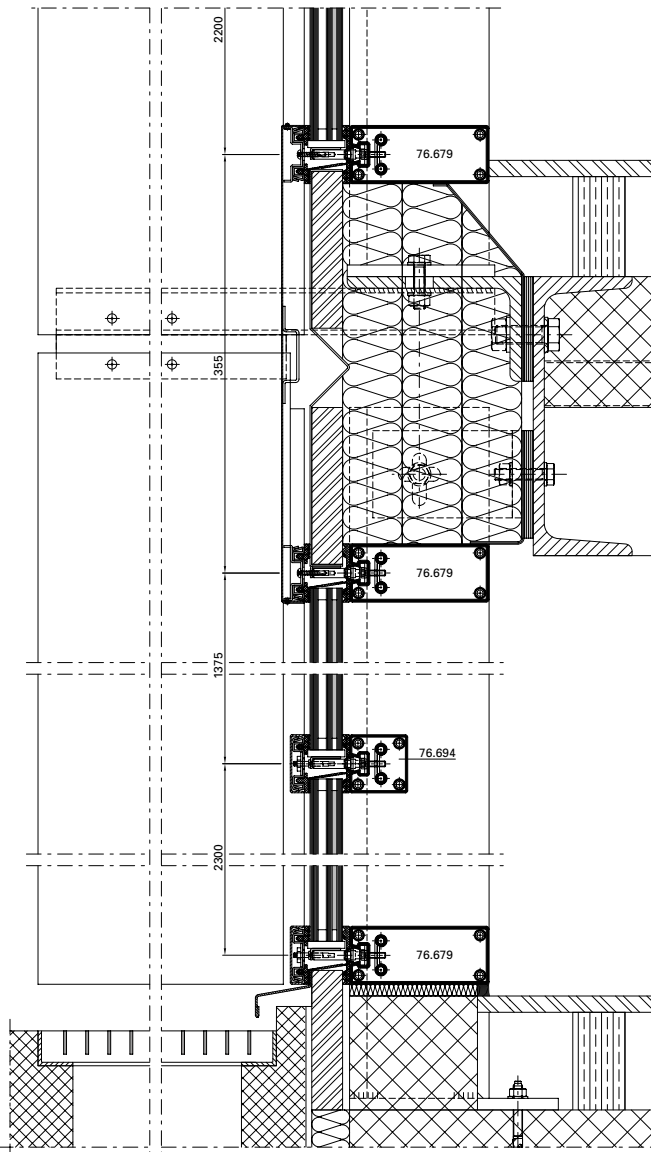

B - B

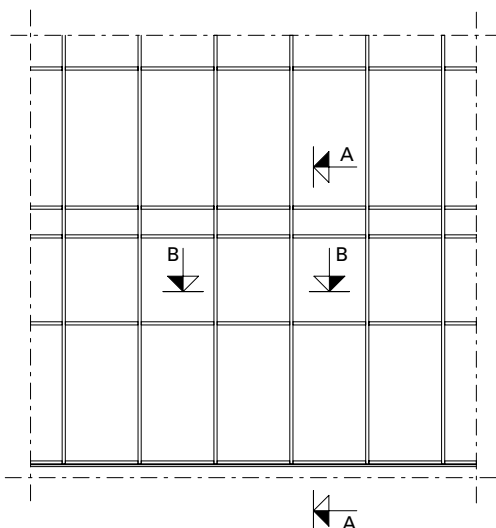
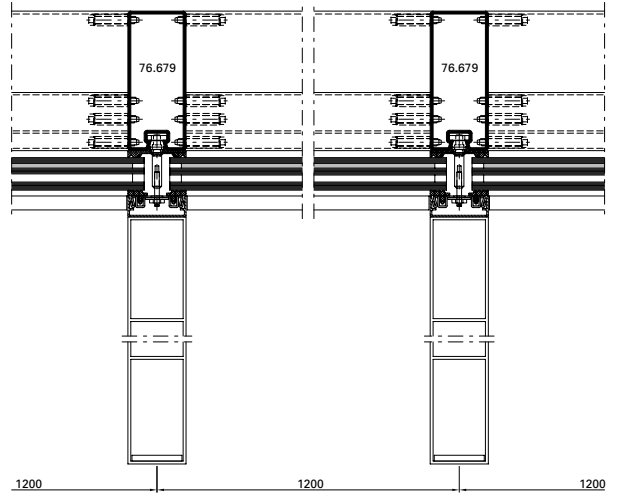

Ausgeführte Objekte Objets réalisés Completed projects

Objekt:

«Mumuth» Haus für Musik & Musiktheater der Kunstuniversität, Graz/AT

System:

VISS TVS

Architekt:

UNStudio, Arch. Ben van Berkel en Bos, Amsterdam/NL

Objet:

«Mumuth» Maison de la musique & du théâtre musical de l'université des arts, Grace/AT

Système:

VISS TVS

Architecte:

UNStudio, Arch. Ben van Berkel en Bos, Amsterdam/NL

Project:

«Mumuth» House of Music & Music Drama at the University of Music and Performing Arts, Graz/AT

System:

VISS TVS

Architect:

UNStudio, Arch. Ben van Berkel en Bos, Amsterdam/NL



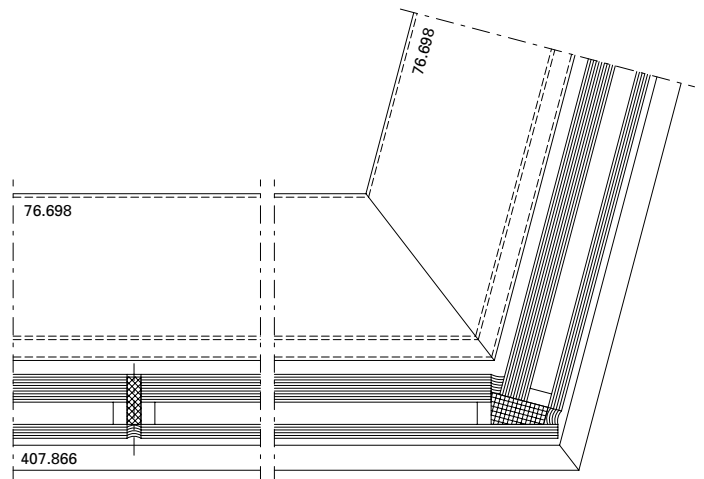
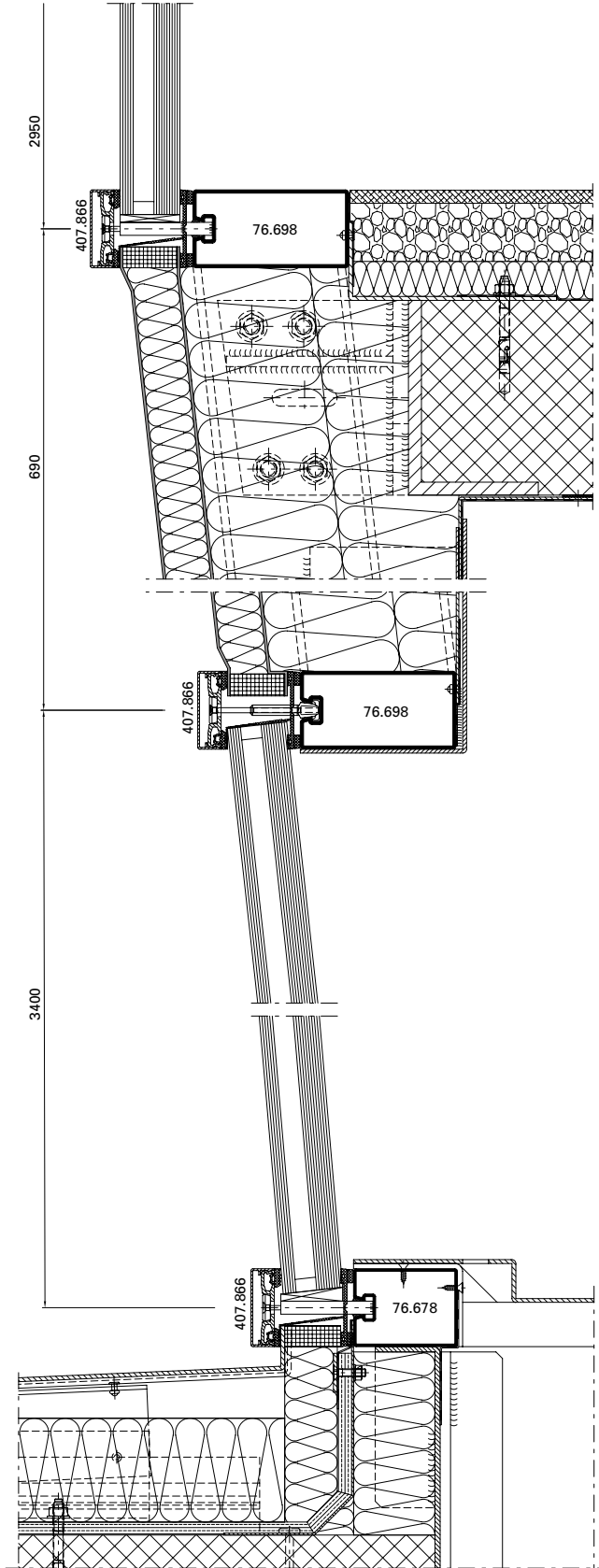

Ausgeführte Objekte
Objets réalisés
Completed projects



Project:

Centre Pompidou, Metz/FR

System:

VISS Fire EI60,
Jansen-Economy 50 E30

Architect:

Shigeru Ban Architects, Paris/FR

Objet:

Centre Pompidou, Metz/FR

Système:

VISS Fire EI60,
Jansen-Economy 50 E30

Architecte:

Shigeru Ban Architects, Paris/FR

Objekt:

Centre Pompidou, Metz/FR

System:

VISS Fire EI60,
Jansen-Economy 50 E30

Architekt:

Shigeru Ban Architects, Paris/FR



Objekt:

Alters- und Pflegeheim,
Burgdorf/CH

System:

VISS Basic TV

Architekt:

Gauer Itten Messerli Architekten AG,
Bern/CH

Objet:

Home pour personnes âgées, Burgdorf/
CH

Système:

VISS Basic TV

Architecte:

Gauer Itten Messerli Architekten AG,
Bern/CH

Project:

Old-age and nursing home, Burgdorf/
CH

System:

VISS Basic TV

Architect:

Gauer Itten Messerli Architekten AG,
Bern/CH

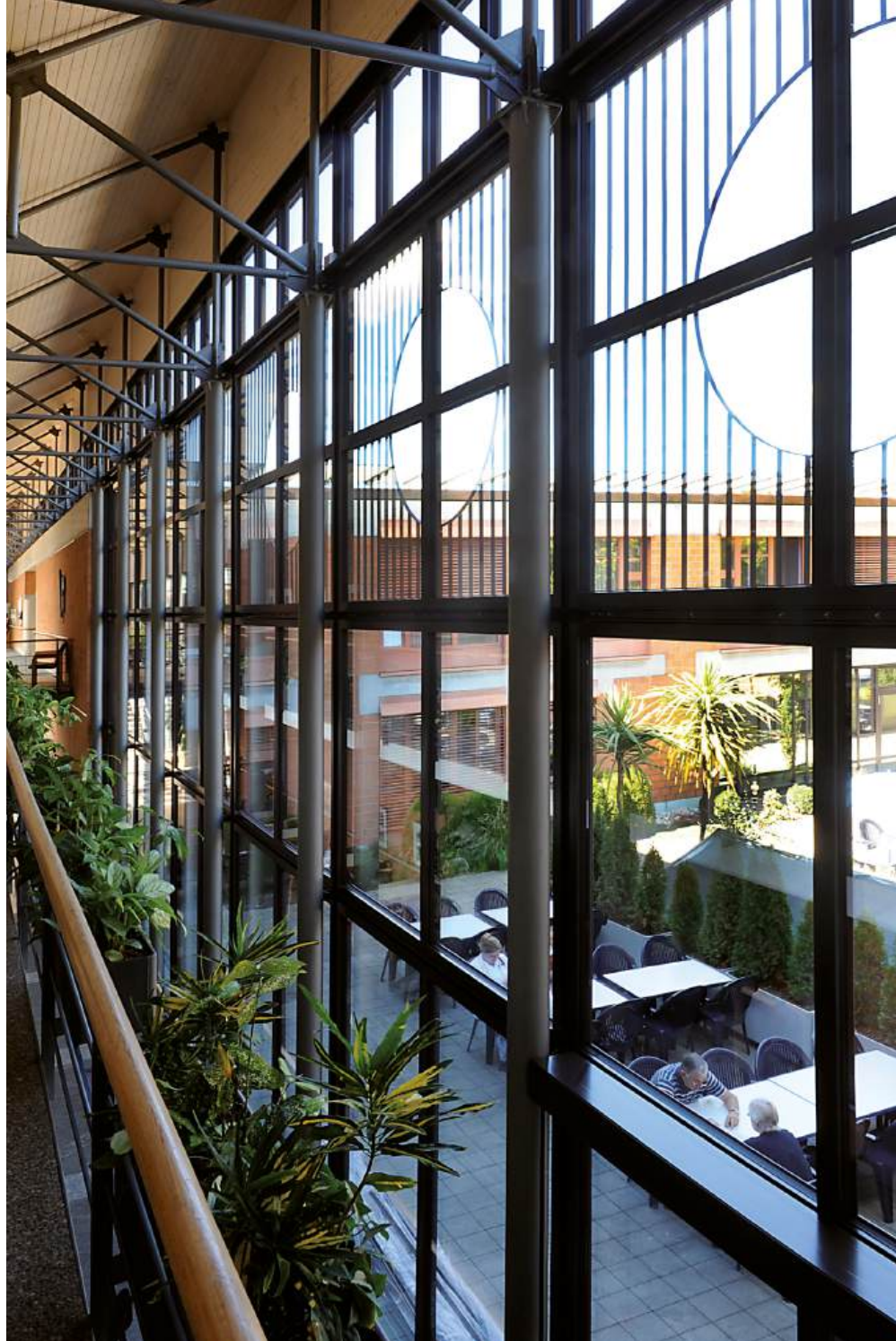

Ausgeführte Objekte Objets réalisés Completed projects

Objekt:

Drents Museum, Assen/NL

System:

VISS Basic TV,
Jansen-Economy 50 EW60

Architekt:

Designed by Erick van Egeraat,
Rotterdam/NL

Objet:

Musée Drents, Assen/NL

Système:

VISS Basic TV,
Jansen-Economy 50 EW60

Architecte:

Designed by Erick van Egeraat,
Rotterdam/NL

Project:

Drents Museum, Assen/NL

System:

VISS Basic TV,
Jansen-Economy 50 EW60

Architect:

Designed by Erick van Egeraat,
Rotterdam/NL



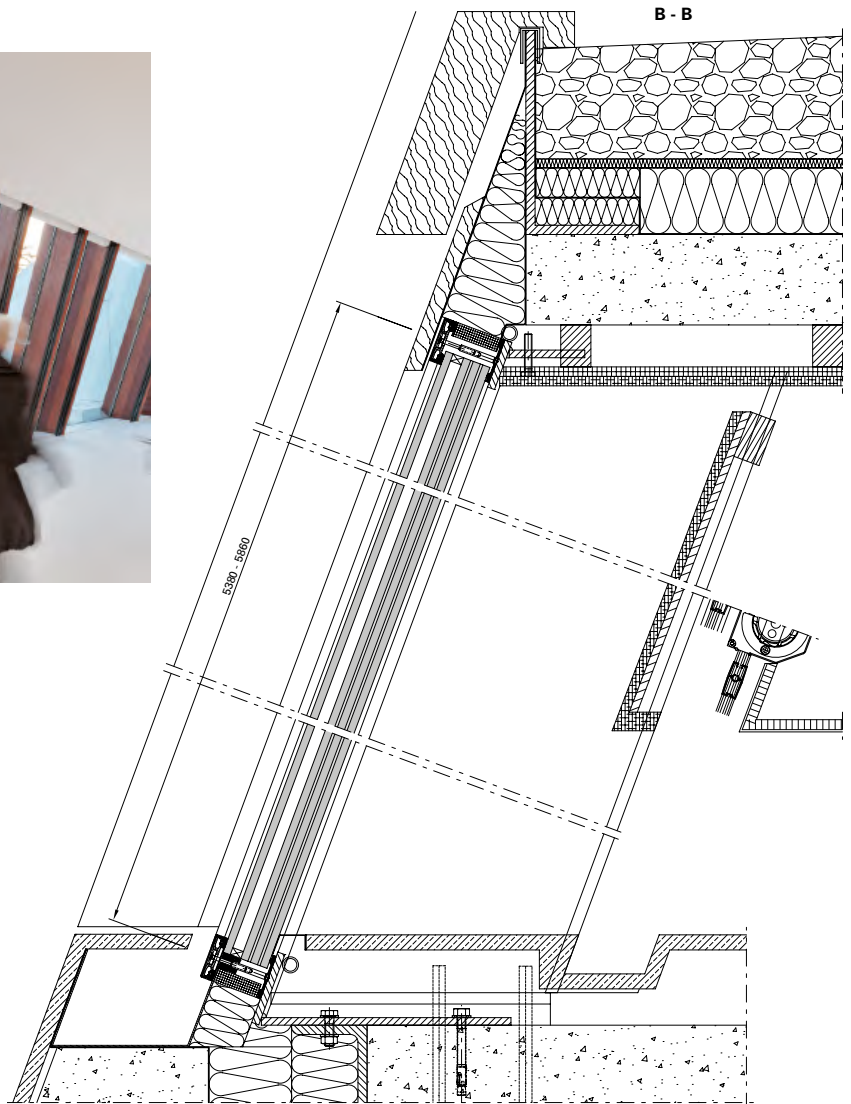
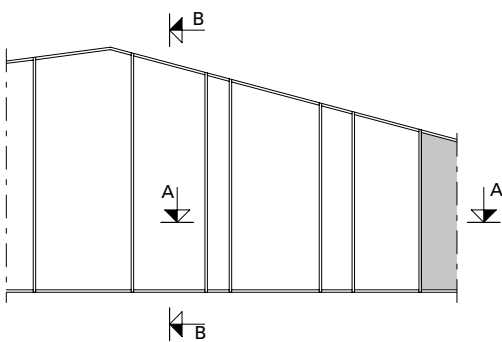
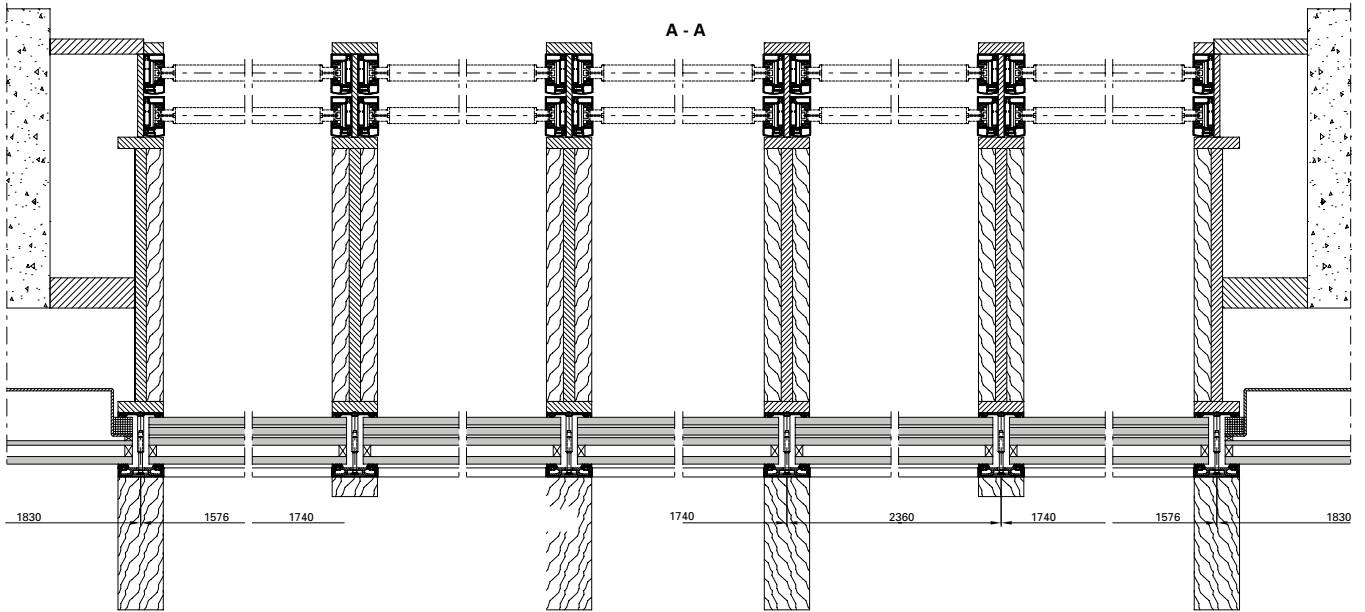

Ausgeführte Objekte Objets réalisés Completed projects

Objekt:

Akkustik-Tunnels,
Warschau/PL

System:

VISS Basic TVS (schräg)

Architekt:

Transprojekt, Warschau/PL
FOROOM Bartłomiej Grotte,
Warschau/PL

Objet:

Tunnels acoustiques,
Varsovie/PL

Système:

VISS Basic TVS (oblique)

Architecte:

Transprojekt, Varsovie/PL
FOROOM Bartłomiej Grotte,
Varsovie/PL

Project:

Acoustic tunnels,
Warsaw/PL

System:

VISS Basic TVS (sloping)

Architect:

Transprojekt, Warsaw/PL
FOROOM Bartłomiej Grotte,
Warsaw/PL

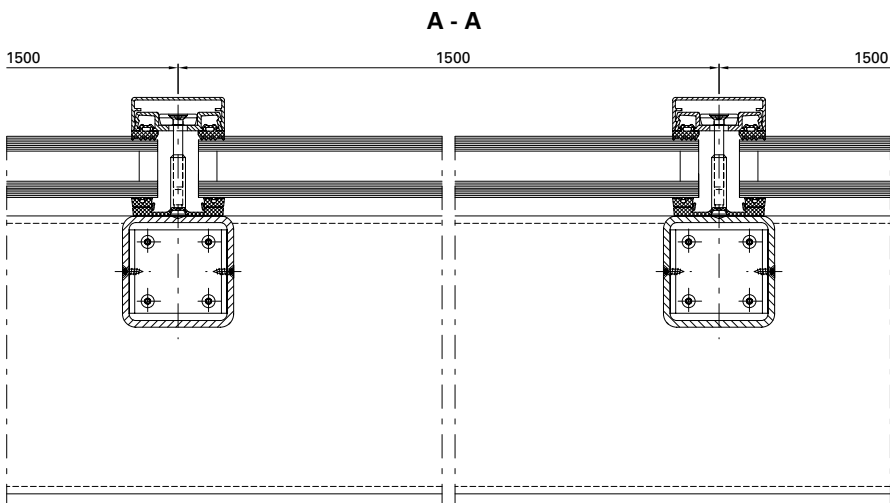

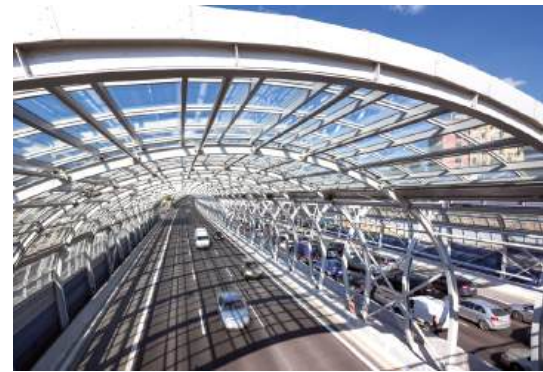
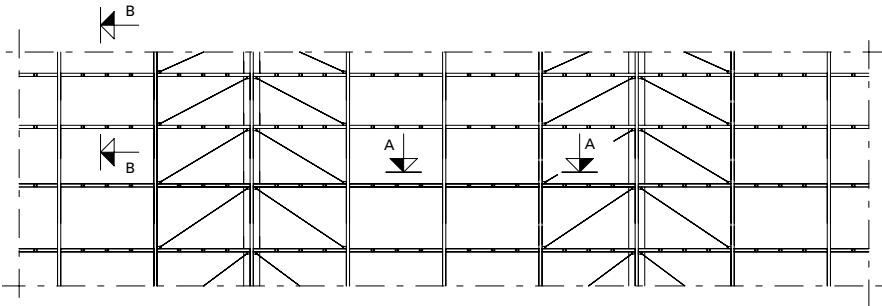
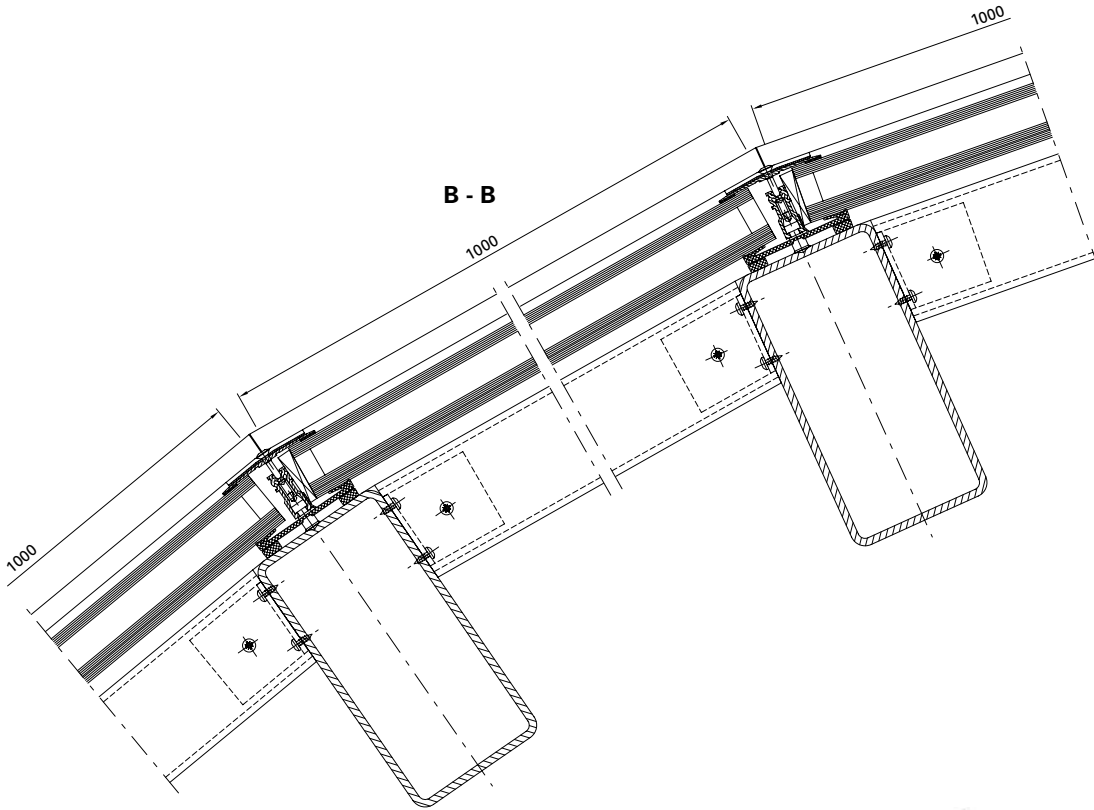

Ausgeführte Objekte
Objets réalisés
Completed projects

Objekt:

Jin Ji Hu Kempinski Hotel, Suzhou/CN

System:

VISS TV

Architekt:

Suzhou Architecture and Design
Institute, Shanghai/CN

Objet:

Hôtel Jin Ji Hu Kempinski, Suzhou/CN

Système:

VISS TV

Architecte:

Suzhou Architecture and Design
Institute, Shanghai/CN

Project:

Jin Ji Hu Kempinski Hotel, Suzhou/CN

System:

VISS TV

Architect:

Suzhou Architecture and Design
Institute, Shanghai/CN



Objekt:

Historisches Museum,
Kharkov/UA

System:

VISS I_xtra, Janisol Türen

Architekt:

S. Chechelnytskiy, M. Polivanova,
T. Polivanova, Kharkov/UA

Objet:

Musée historique,
Kharkov/UA

Système:

VISS I_xtra, portes Janisol

Architecte:

S. Chechelnytskiy, M. Polivanova,
T. Polivanova, Kharkov/UA

Project:

Historical museum,
Kharkov/UA

System:

VISS I_xtra, Janisol doors

Architect:

S. Chechelnytskiy, M. Polivanova,
T. Polivanova, Kharkov/UA

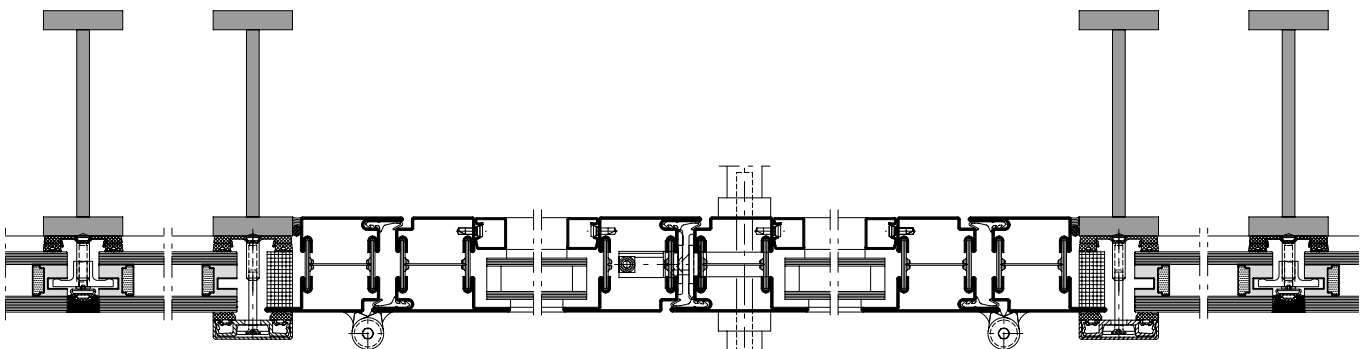

Ausgeführte Objekte

Objets réalisés

Completed projects

Objekt:

Kunstgebäude, Stuttgart/DE

System:

VISS TVS (schräg)

Architekt:

Harder III Stumpf, Freie Architekten,
Stuttgart/DE

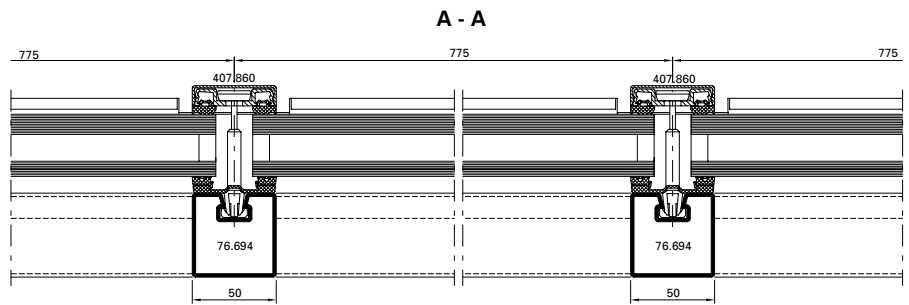

Objet:

Bâtiment des arts, Stuttgart/DE

Système:

VISS TVS (oblique)

Architecte:

Harder III Stumpf, Freie Architekten,
Stuttgart/DE

Project:

Art building, Stuttgart/DE

System:

VISS TVS (sloping)

Architect:

Harder III Stumpf, Freie Architekten,
Stuttgart/DE



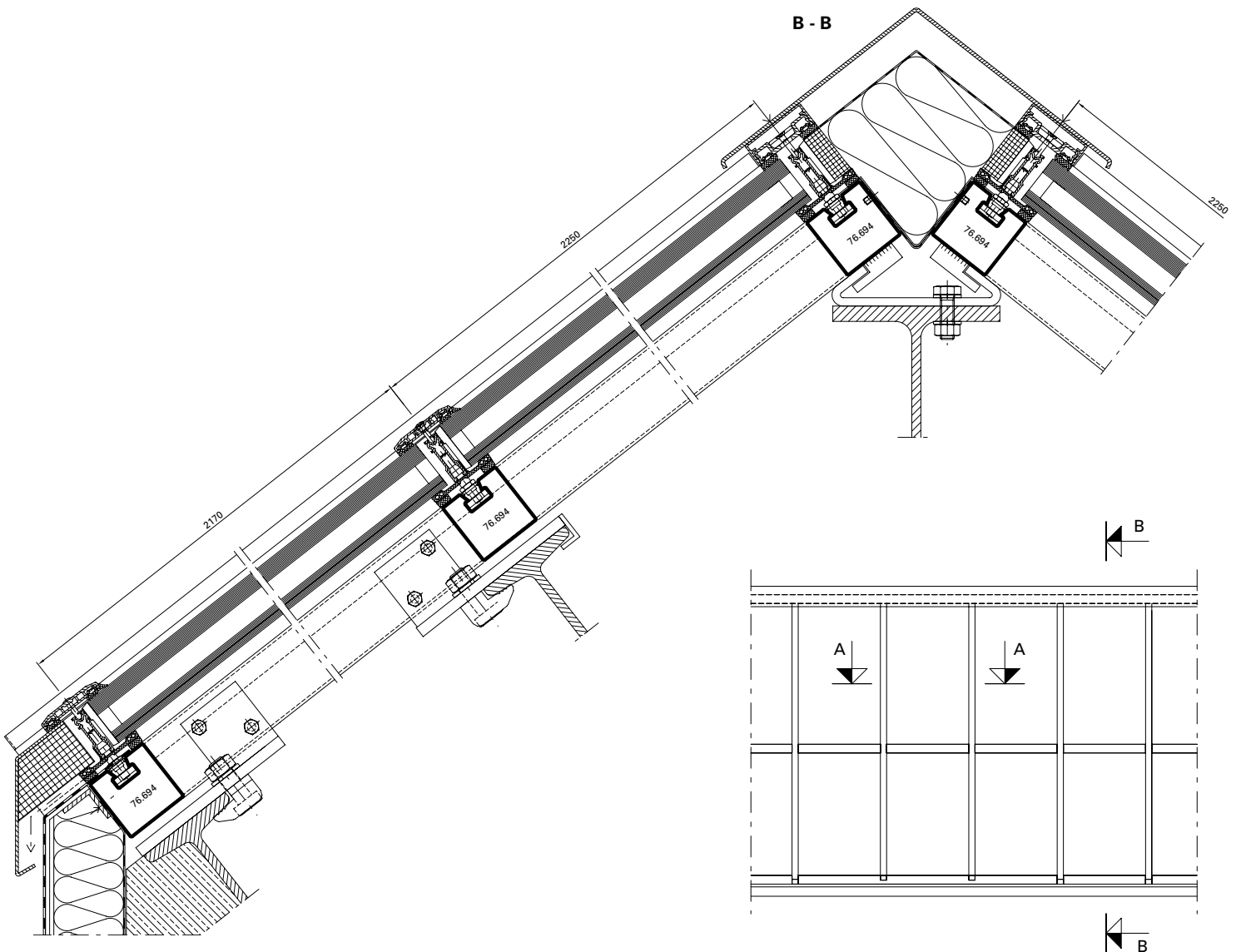

Ausgeführte Objekte

Objets réalisés

Completed projects

Objekt:

3-Feldsporthalle, Ingelfingen/DE

System:

VISS TVS HI, VISS Fire E30/E90,
Janisol Primo, Janisol Türen,
Janisol 2 E130, Jansen-Economy 60

Architekt:

Hein, Hüttel und Lindenberger,
Ludwigsburg/DE

Objet:

Salle de sport triple, Ingelfingen/DE

Système:

VISS TVS HI, VISS Fire E30/E90,
Janisol Primo, portes Janisol,
Janisol 2 E130, Jansen-Economy 60

Architecte:

Hein, Hüttel und Lindenberger,
Ludwigsburg/DE

Project:

3-field sports hall, Ingelfingen/DE

System:

VISS TVS HI, VISS Fire E30/E90,
Janisol Primo, Janisol doors,
Janisol 2 E130, Jansen-Economy 60

Architect:

Hein, Hüttel und Lindenberger,
Ludwigsburg/DE

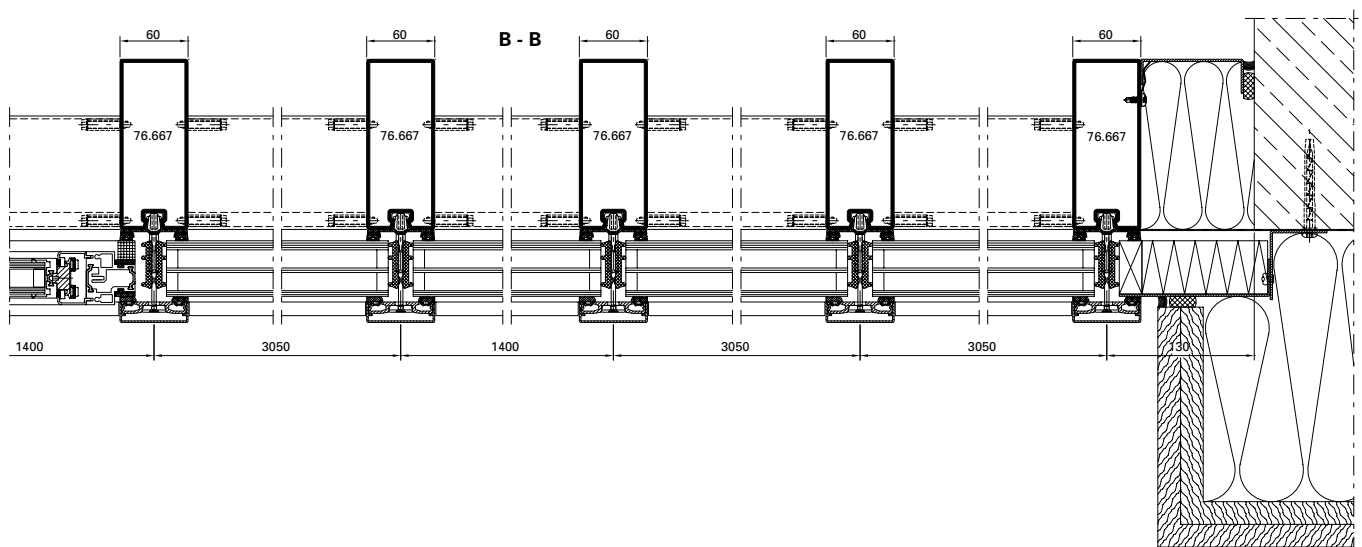

A - A

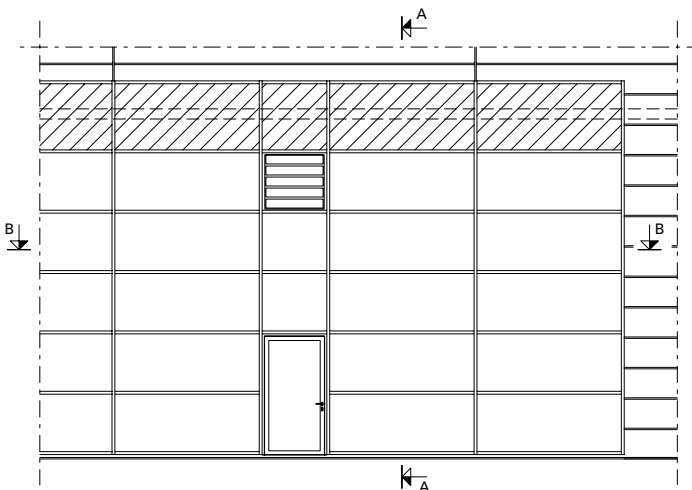
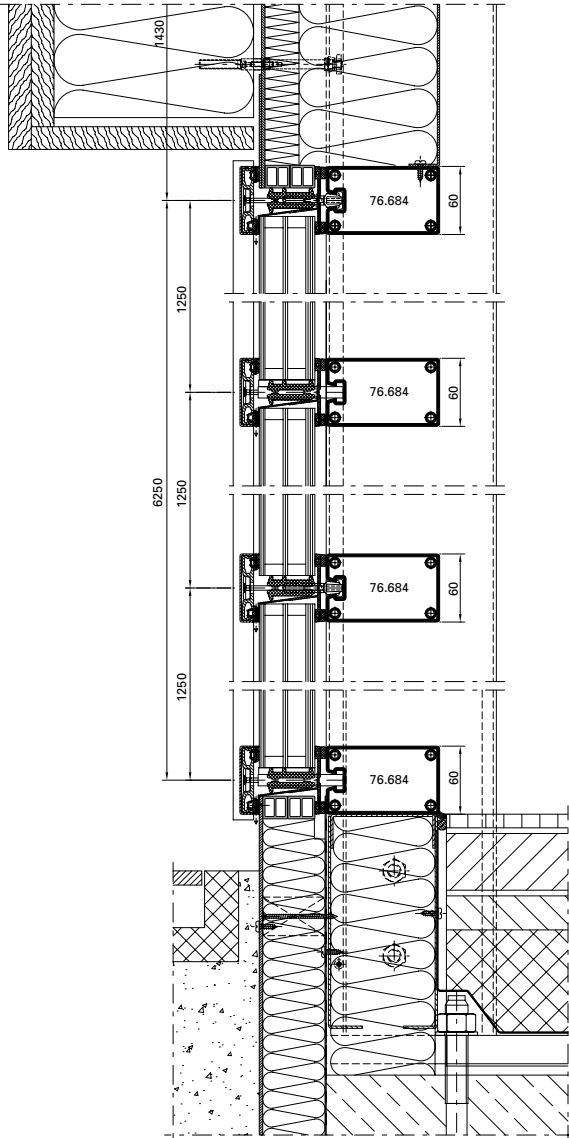

Ausgeführte Objekte

Objets réalisés

Completed projects

Objekt:

Musikkonservatorium, Bilbao/ES

System:

VISS TVS

Architekt:

Roberto Ercilla Arquitectura,
Vitoria/ES

Objet:

Conservatoire de musique, Bilbao/ES

Système:

VISS TVS

Architecte:

Roberto Ercilla Arquitectura,
Vitoria/ES

Project:

Conservatory of Music, Bilbao/ES

System:

VISS TVS

Architect:

Roberto Ercilla Arquitectura,
Vitoria/ES



Objekt:

Landesberufsschule, Mureck/AT

System:

VISS TVS Linea

Architekt:

Architekten Domenig & Wallner
ZT GmbH, Graz/AT

Objet:

École professionnelle, Mureck/AT

Système:

VISS TVS Linea

Architecte:

Architekten Domenig & Wallner
ZT GmbH, Graz/AT

Project:

State vocational school, Mureck/AT

System:

VISS TVS Linea

Architect:

Architekten Domenig & Wallner
ZT GmbH, Graz/AT



Ausgeführte Objekte
Objets réalisés
Completed projects



Fotos: Jochen Helle, Dortmund

Objekt:

Hafencity Schule, Hamburg/DE

System:

VISS Fire E30 TVS vertikal und schräg,
Janisol Türen

Architekt:

Spengler-Wiescholek Architekten,
Hamburg/DE

Objet:

École Hafencity, Hamburg/DE

Système:

VISS Fire E30 TVS vertical et oblique,
Portes Janisol

Architecte:

Spengler-Wiescholek Architekten,
Hamburg/DE

Project:

Hafencity school, Hamburg/DE

System:

VISS Fire E30 TVS vertical and sloping,
Janisol doors

Architect:

Spengler-Wiescholek Architekten,
Hamburg/DE



A - A

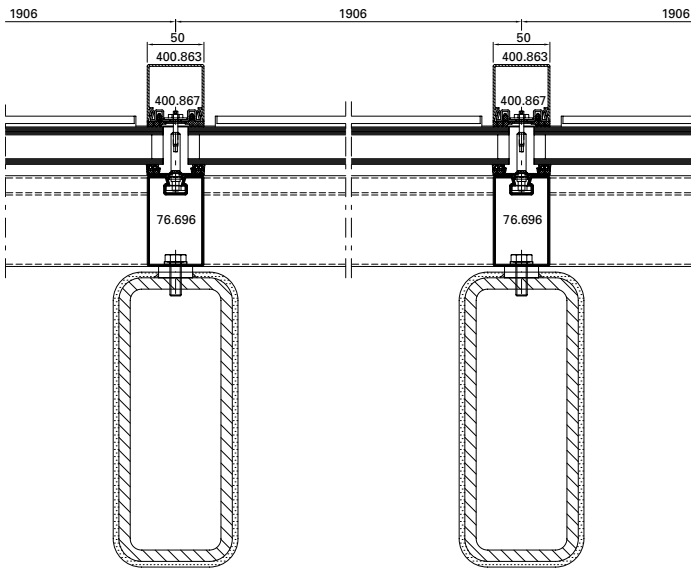

B

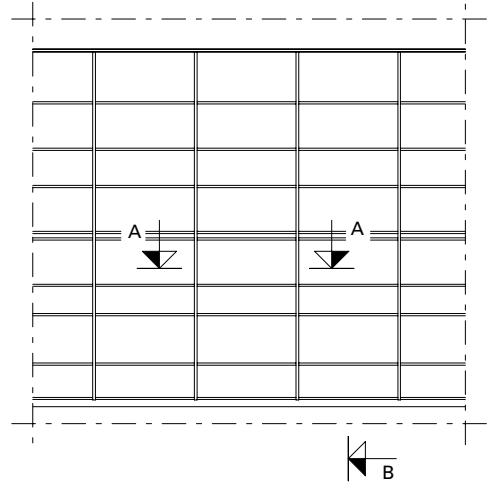

B - B

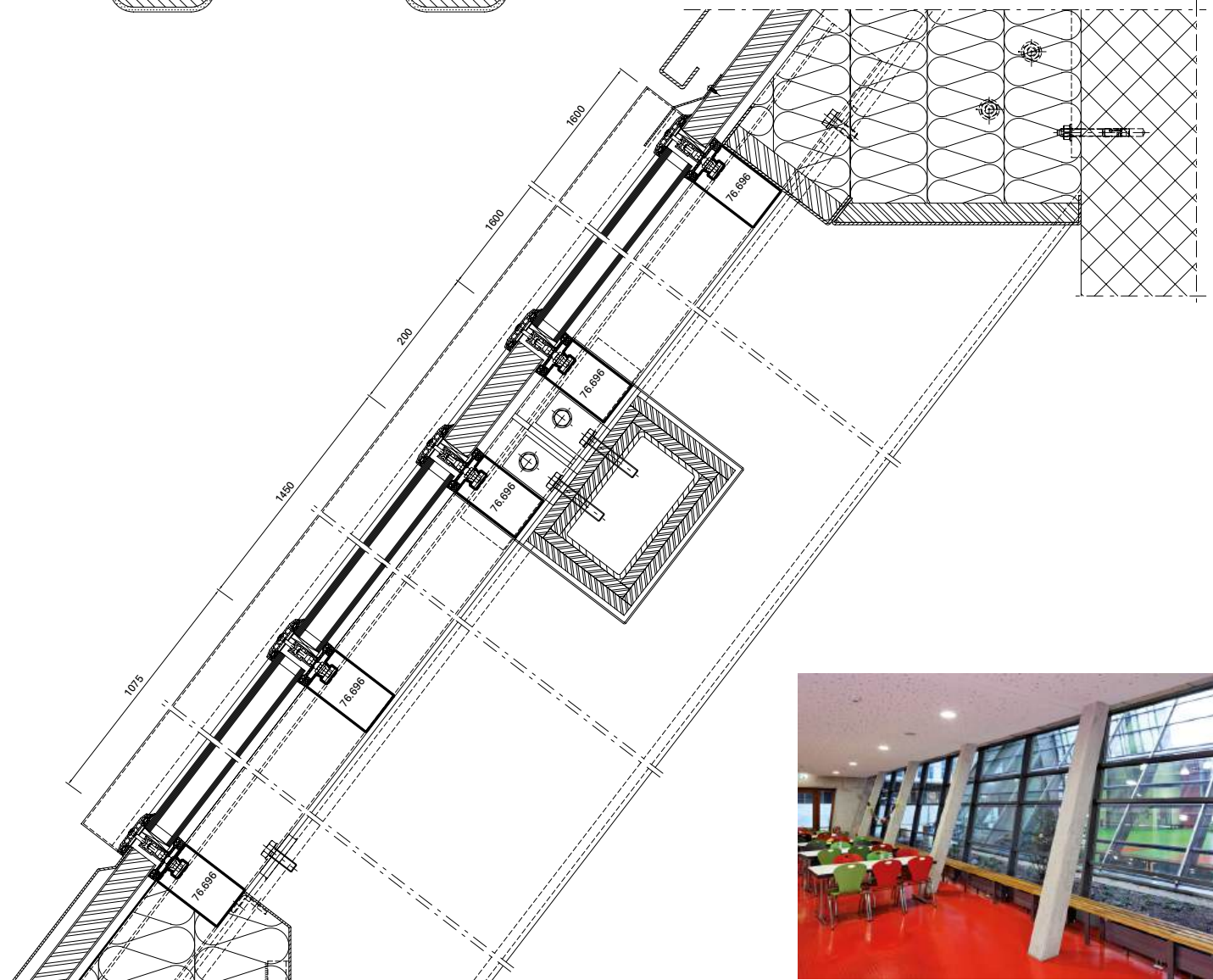

Ausgeführte Objekte

Objets réalisés

Completed projects

Objekt:

Drehrestaurant «Hoher Kasten»,
Brülisau/CH

System:

VISS Basic TVS

Architekt:

architekten : rlc ag, Rheineck/CH

Objet:

Restaurant panoramique
«Hoher Kasten», Brülisau/CH

Système:

VISS Basic TVS

Architecte:

architekten : rlc ag, Rheineck/CH

Project:

Revolving restaurant «Hoher Kasten»,
Brülisau/CH

System:

VISS Basic TVS

Architect:

architekten : rlc ag, Rheineck/CH

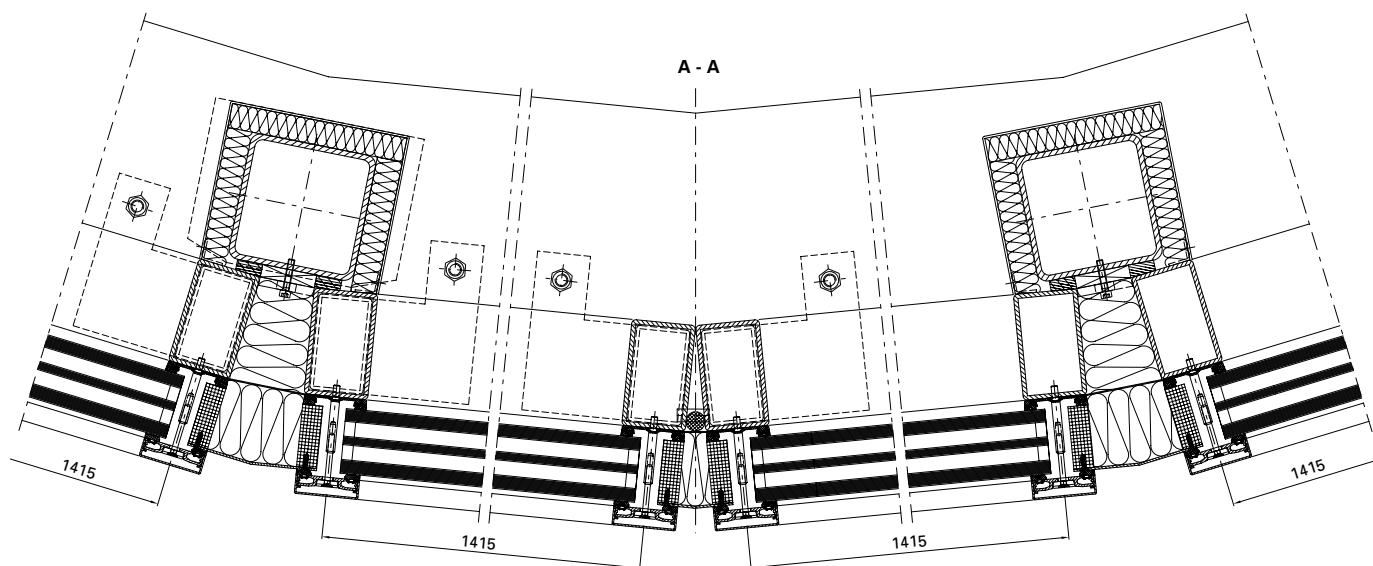

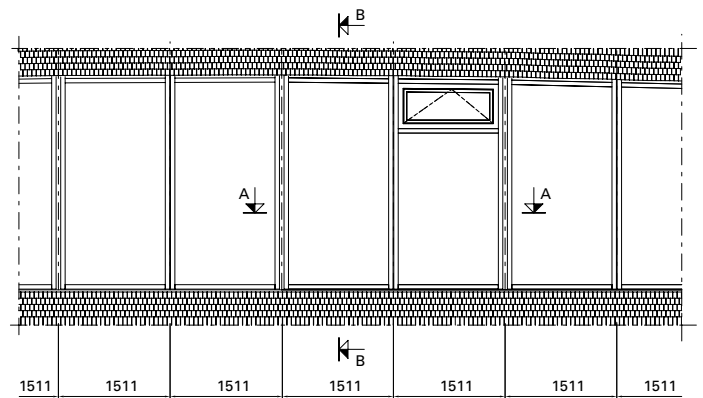
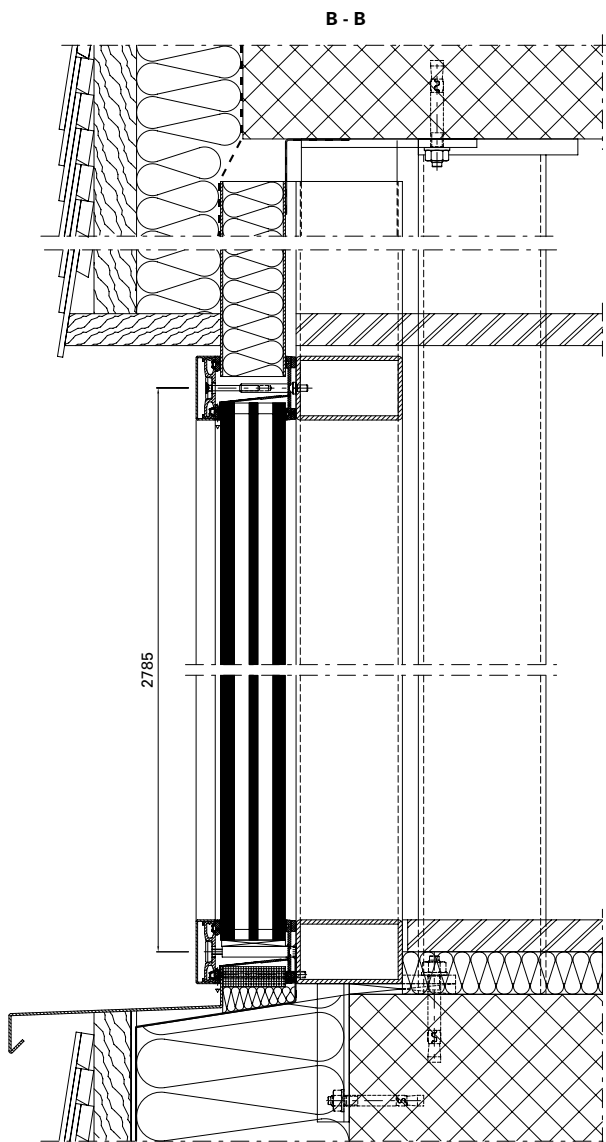

Ausgeführte Objekte

Objets réalisés

Completed projects

Objekt:

Hauptbahnhof «Rotterdam Centraal»,
Rotterdam/NL

System:

VISS Basic, VISS Fire, Janisol Türen

Architekt:

Team CS: Zusammenarbeit von
Bentham Crowel Architekten,
Meyer en Van Schooten Architecten
und West 8, Rotterdam/NL

Objet:

Gare centrale «Rotterdam Centraal»,
Rotterdam/NL

Système:

VISS Basic, VISS Fire, portes Janisol

Architecte:

Team CS: Coopération de Bentham
Crowel Architectes, Meyer en Van
Schooten Architectes et West 8,
Rotterdam/NL

Project:

Central station «Rotterdam Centraal»,
Rotterdam/NL

System:

VISS Basic, VISS Fire, Janisol doors

Architect:

Team CS: a cooperation of Bentham
Crowel Architects, Meyer en Van
Schooten Architects and West 8,
Rotterdam/NL

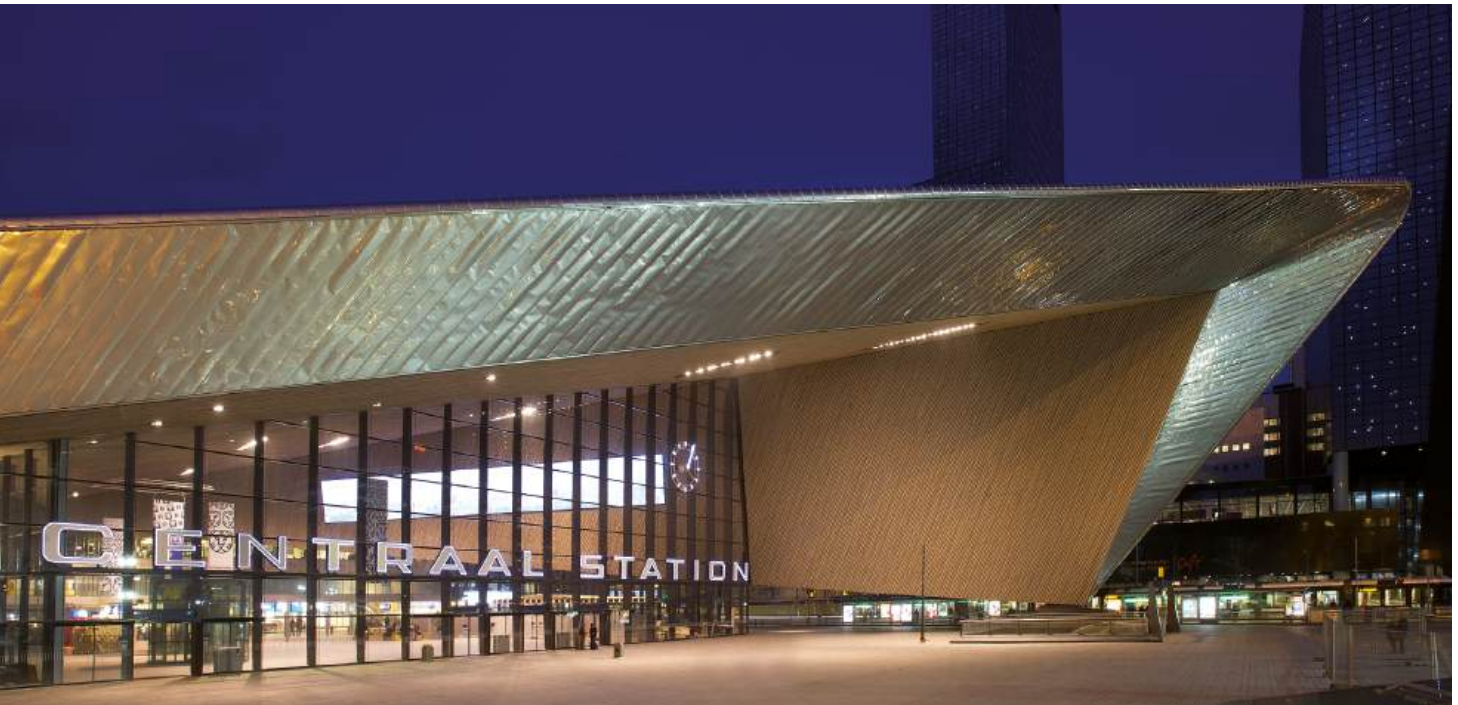



Ausgeführte Objekte

Objets réalisés

Completed projects

Objekt:

IGuzzini Illuminazione, Barcelona/ES

System:

VISS TVS, Janisol Fenster und Türen,
Jansen-Economy 50/60

Architekt:

Josep Mias, Mias Arquitectos ACTAR,
Barcelona/ES

Objet:

IGuzzini Illuminazione, Barcelone/ES

Système:

VISS TVS, Janisol portes et fenêtres,
Jansen-Economy 50/60

Architecte:

Josep Mias, Mias Arquitectos ACTAR,
Barcelone/ES

Project:

IGuzzini Illuminazione, Barcelona/ES

System:

VISS TVS, Janisol doors and windows,
Jansen-Economy 50/60

Architect:

Josep Mias, Mias Arquitectos ACTAR,
Barcelona/ES

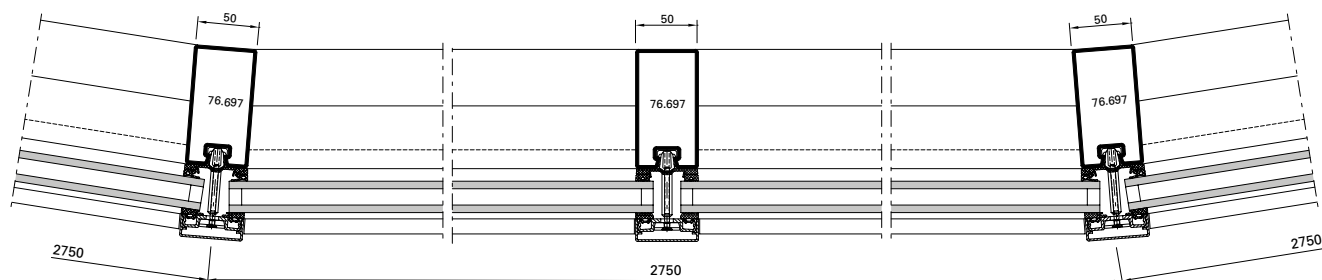

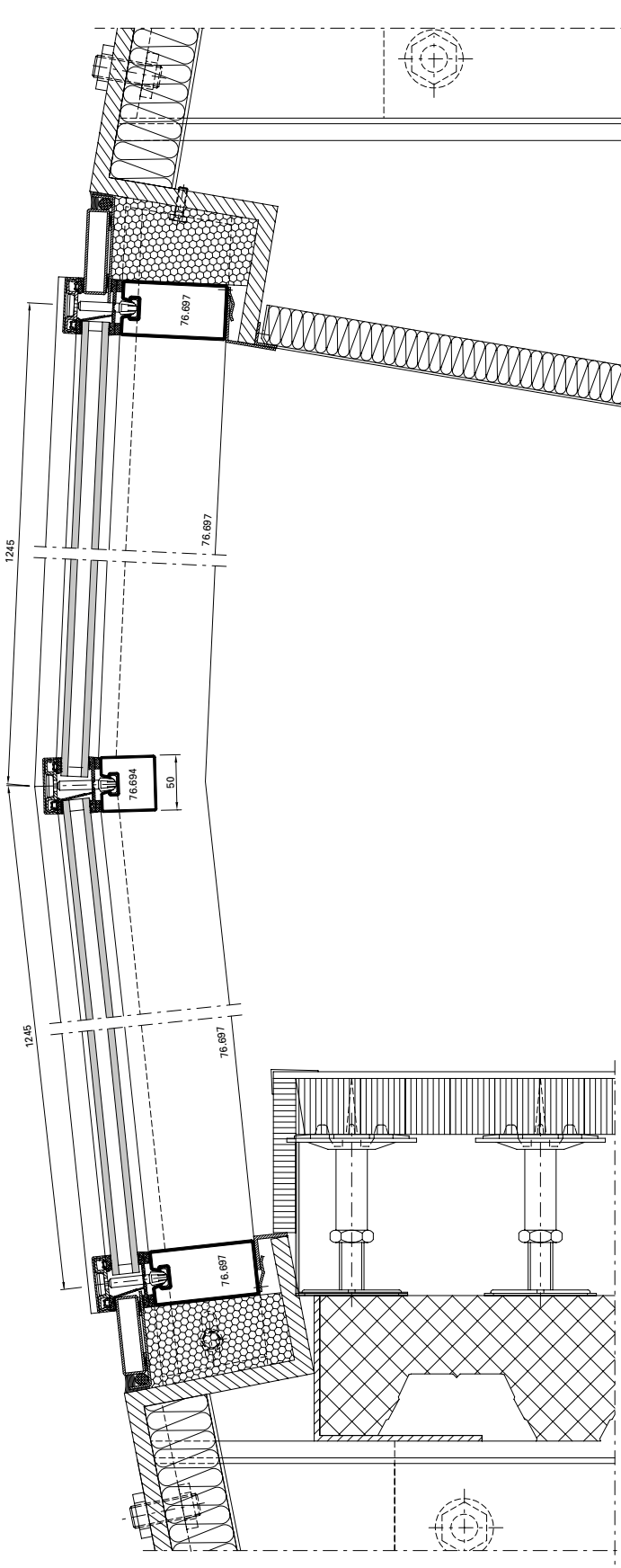

Ausgeführte Objekte

Objets réalisés

Completed projects

Objekt:

«Erasmus» Studenten-Pavillon,
Rotterdam/NL

System:

VISS I_xtra SG

Architekt:

Powerhouse Company &
DeZwarteHond, Rotterdam/NL

Objet:

Pavillon pour étudiants «Erasmus»,
Rotterdam/NL

Système:

VISS I_xtra SG

Architecte:

Powerhouse Company &
DeZwarteHond, Rotterdam/NL

Project:

«Erasmus» student pavilion,
Rotterdam/NL

System:

VISS I_xtra SG

Architect:

Powerhouse Company &
DeZwarteHond, Rotterdam/NL

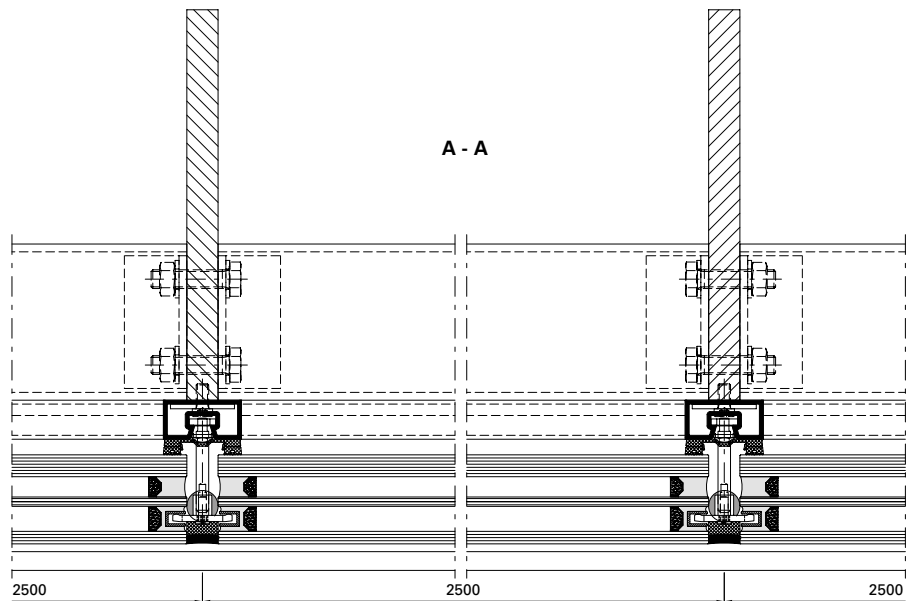

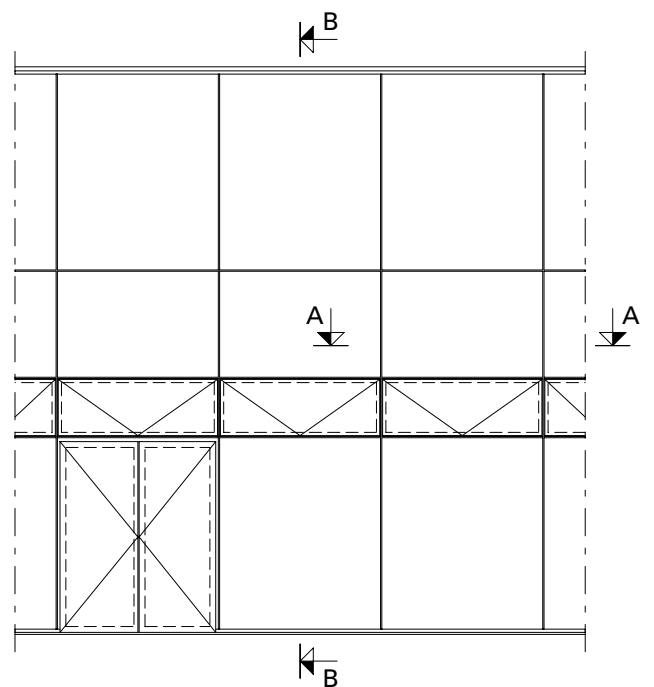
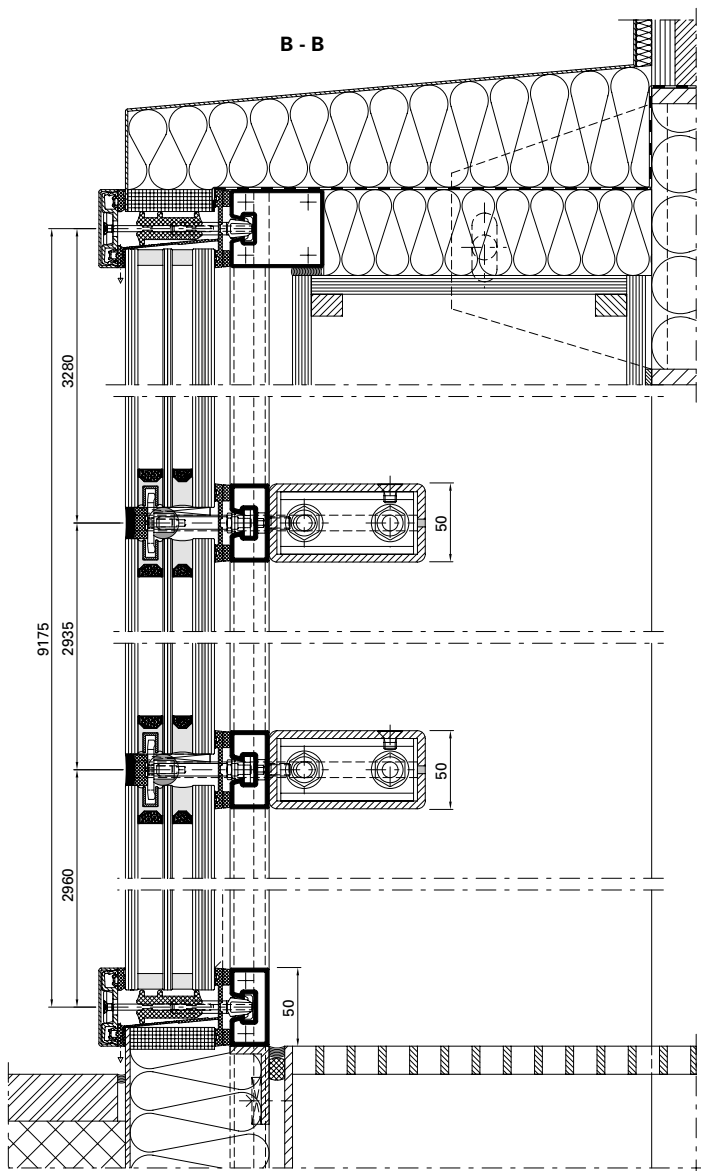

Ausgeführte Objekte
Objets réalisés
Completed projects



Fotos: Stephan Falk, Berlin

Objekt:

Hochschule «Anstalt für angewandte Wissenschaften», Dessau/DE

System:

VISS TVS

Architekt:

Kossel, Simon und Partner,
Magdeburg/DE

Objet:

École supérieure «Anstalt für angewandte Wissenschaften», Dessau/DE

Système:

VISS TVS

Architecte:

Kossel, Simon und Partner,
Magdeburg/DE

Project:

University «Anstalt für angewandte Wissenschaften», Dessau/DE

System:

VISS TVS

Architect:

Kossel, Simon und Partner,
Magdeburg/DE



Objekt:

Justizgebäude, Würzburg/DE

System:

VISS TVS, VISS Fire TVS (schräg)

Architekt:

Staatliches Bauamt Würzburg, Abt. L4, Würzburg/DE

Objet:

Palais de justice, Würzburg/DE

Système:

VISS TVS, VISS Fire TVS (oblique)

Architecte:

Staatliches Bauamt Würzburg, Abt. L4, Würzburg/DE

Project:

Law courts, Würzburg/DE

System:

VISS TVS, VISS Fire TVS (sloping)

Architect:

Staatliches Bauamt Würzburg, Abt. L4, Würzburg/DE



Fotos: Gerhard Hagen, Bamberg

Ausgeführte Objekte

Objets réalisés

Completed projects

Objekt:

Halle M, Jansen AG, Oberriet/CH

System:

VISS TVS HI

Architekt:

Göldi + Eggenberger AG,
Altstätten/CH

Objet:

Hall M, Jansen AG, Oberriet/CH

Système:

VISS TVS HI

Architecte:

Göldi + Eggenberger AG,
Altstätten/CH

Project:

Hall M, Jansen AG, Oberriet/CH

System:

VISS TVS HI

Architect:

Göldi + Eggenberger AG,
Altstätten/CH



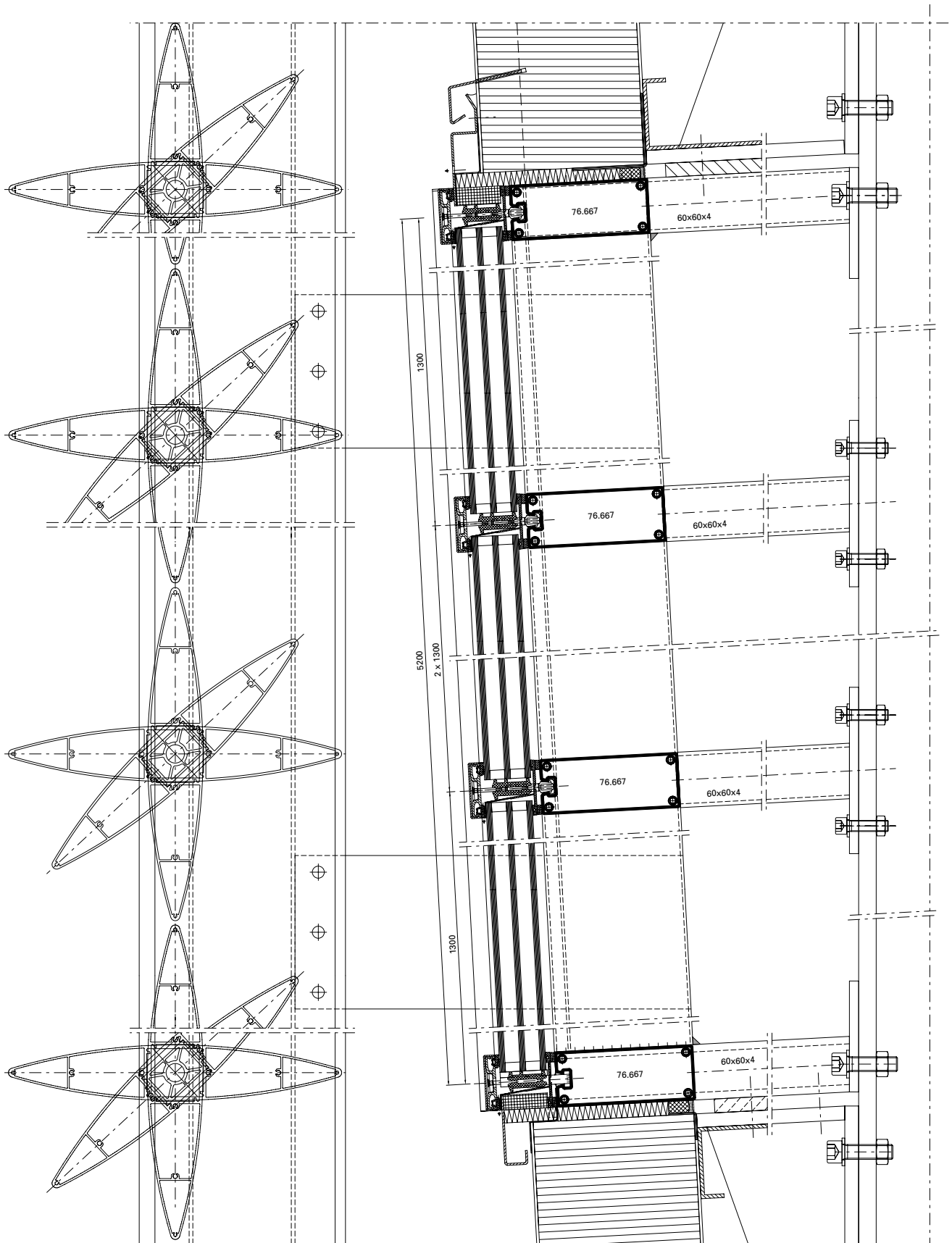

Ausgeführte Objekte
Objets réalisés
Completed projects



Fotos: Stephan Falk, Berlin

Objekt:

Vogtlandhalle (Stadthalle), Greiz/DE

System:

VISS TVS, Janisol Faltwand

Architekt:

Hoffmann.Seifert.Partner mit Ernst Scharf, Erfurt/DE

Objet:

Vogtlandhalle (salle municipale), Greiz/DE

Système:

VISS TVS, Janisol porte repliable

Architecte:

Hoffmann.Seifert.Partner mit Ernst Scharf, Erfurt/DE

Project:

Vogtland hall (city hall), Greiz/DE

System:

VISS TVS, Janisol folding wall

Architect:

Hoffmann.Seifert.Partner mit Ernst Scharf, Erfurt/DE

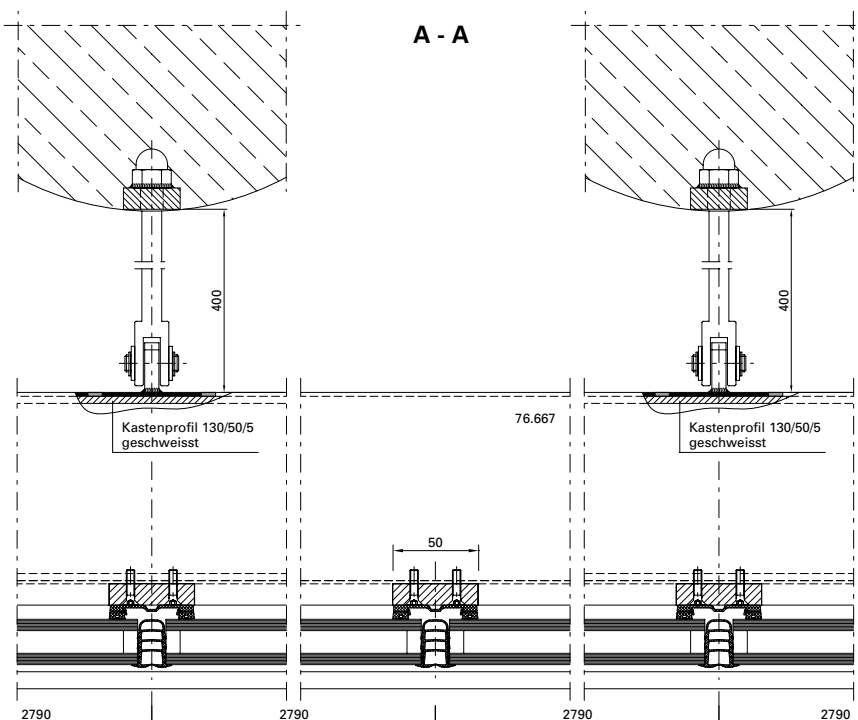

B - B

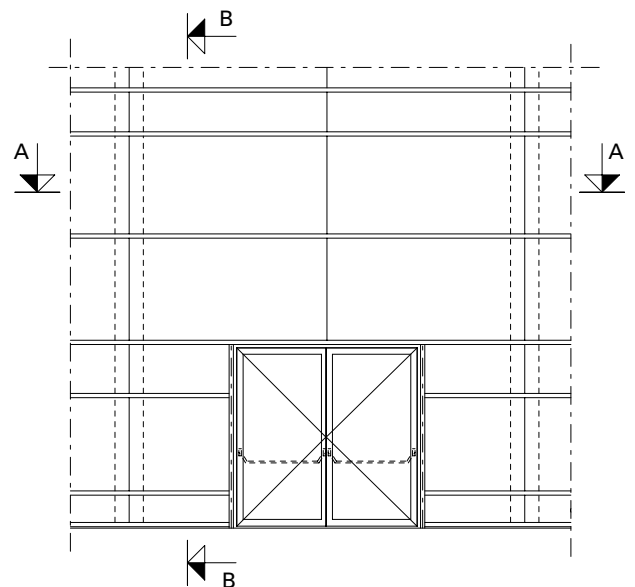
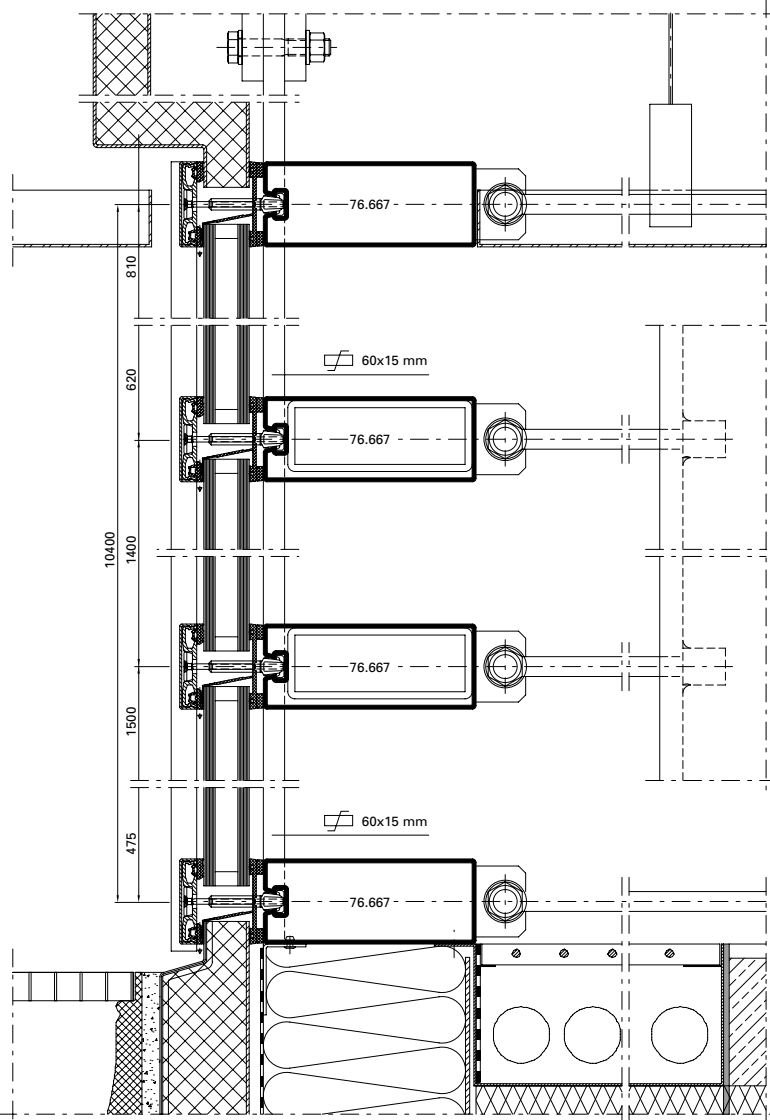

Ausgeführte Objekte Objets réalisés Completed projects

Objekt:

Ausbau Messehalle BEA Expo,
Bern/CH

System:

VISS Fire E30/EI30,
Jansen-Economy E30, Janisol 2 EI30

Architekt:

Schwaar & Partner AG, Bern/CH

Objet:

Agrandissement du hall d'exposition
BEA Expo, Berne/CH

Système:

VISS Fire E30/EI30,
Jansen-Economy E30, Janisol 2 EI30

Architecte:

Schwaar & Partner AG, Berne/CH

Project:

Exhibition hall extension BEA Expo,
Bern/CH

System:

VISS Fire E30/EI30,
Jansen-Economy E30, Janisol 2 EI30

Architect:

Schwaar & Partner AG, Bern/CH



Objekt:

MAN Nutzfahrzeuge, Werkserweiterung,
München/DE

System:

VISS I_xtra, Janisol Türen

Architekt:

DMP Architekten BDA, München/DE

Objet:

MAN Nutzfahrzeuge, agrandissement
de l'usine, Munich/DE

Système:

VISS I_xtra, portes Janisol

Architecte:

DMP Architekten BDA, Munich/DE

Project:

MAN Nutzfahrzeuge, plant extension,
Munich/DE

System:

VISS I_xtra, Janisol doors

Architect:

DMP Architekten BDA, Munich/DE



Fotos: Bernhard Lattner, Heilbronn

Ausgeführte Objekte Objets réalisés Completed projects

Objekt:

Museumsquartier, Den Bosch/NL

System:

VISS I_xtra TV

Architekt:

Bierman Henket Architecten, Esch/NL

Objet:

Quartier des musées, Den Bosch/NL

Système:

VISS I_xtra TV

Architecte:

Bierman Henket Architecten, Esch/NL

Project:

Museum Quarter, Den Bosch/NL

System:

VISS I_xtra TV

Architect:

Bierman Henket Architecten, Esch/NL



B - B

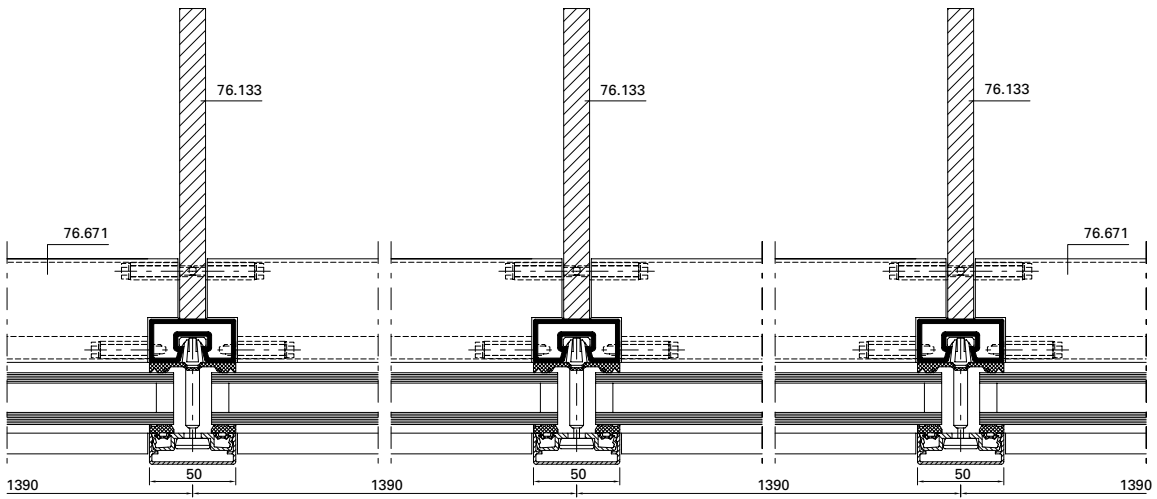

A - A

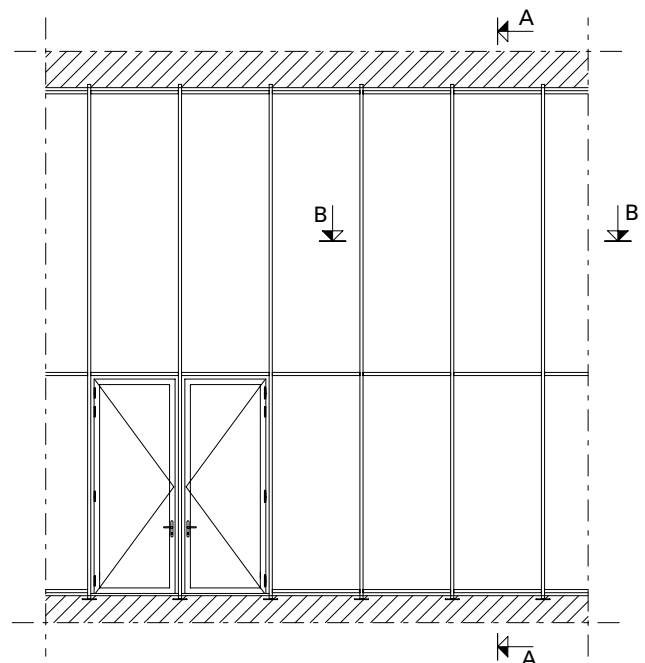
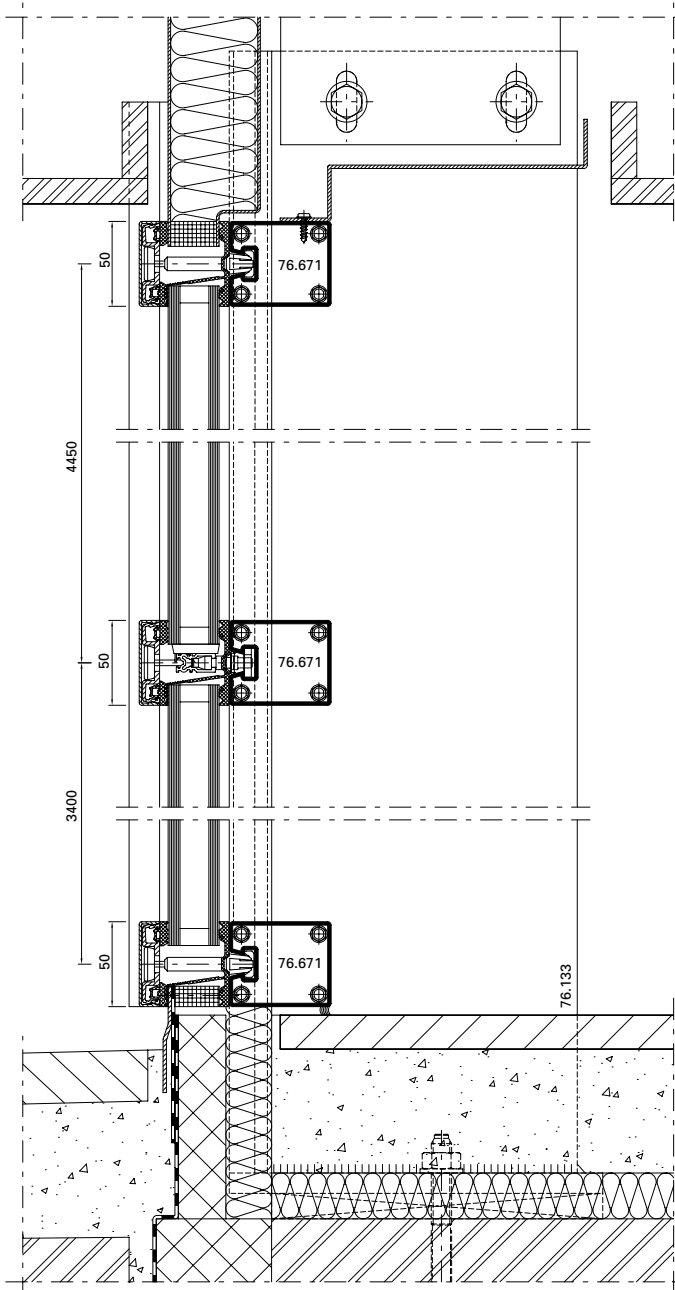

Ausgeführte Objekte Objets réalisés Completed projects

Objekt:

Werkhalle Glas Trösch,
St.Gallen/CH

System:

VISS TVS

Architekt:

Schuchter Ehle, Architekten, St.Gallen/
CH

Objet:

Atelier de Glas Trösch,
Saint-Gall/CH

Système:

VISS TVS

Architecte:

Schuchter Ehle, Architekten,
Saint-Gall/CH

Project:

Glas Trösch factory building,
St. Gallen/CH

System:

VISS TVS

Architect:

Schuchter Ehle, Architekten, St.Gallen/
CH





Objekt:

Voentorg Center,
Moskau/RU

System:

VISS TV, VISS Fire

Architekt:

Mosprojekt-2: Kolosnitsin Vladimir
Vasilyevich / Starikov Alexander
Fedorovich, Moskau/RU

Objet:

Centre Voentorg,
Moscou/RU

Système:

VISS TV, VISS Fire

Architecte:

Mosprojekt-2: Kolosnitsin Vladimir
Vasilyevich / Starikov Alexander
Fedorovich, Moscou/RU

Project:

Voentorg Center,
Moscow/RU

System:

VISS TV, VISS Fire

Architect:

Mosprojekt-2: Kolosnitsin Vladimir
Vasilyevich / Starikov Alexander
Fedorovich, Moscow/RU



Ausgeführte Objekte Objets réalisés Completed projects

Objekt:

Neue Messehalle
(Kielce Trade Fairs), Kielce/PL

System:

VISS TVS (vertikal und schräg),
Janisol 2 E130, Falttore

Architekt:

bsp Architekten: Barbara Średniawa,
Gliwice/PL

Objet:

Nouveau hall d'exposition
(Kielce Trade Fairs), Kielce/PL

Système:

VISS TVS (vertical et oblique),
Janisol 2 E130, Porte accordéon

Architecte:

bsp Architekten: Barbara Średniawa,
Gliwice/PL

Project:

New exhibition hall
(Kielce Trade Fairs), Kielce/PL

System:

VISS TVS (vertical and sloping),
Janisol 2 E130, Folding doors

Architect:

bsp Architekten: Barbara Średniawa,
Gliwice/PL



