

Jansen-Economy 60 RS (Smoke)

Rauchschutztüren nach EN 1634-3 und EN 16034 aus Stahl

Jansen-Economy 60 RS (Smoke)

Portes coupe-fumée selon EN 1634-3 et EN 16034 en acier

Jansen-Economy 60 RS (Smoke)

Smoke control doors according to EN 1634-3 and EN 16034 in steel

Grafische Planungsdaten wie z.B. Anwendungsbeispiele, Konstruktionsdetails, Anschlüsse am Bau, die in unseren physischen oder elektronischen Dokumentationsunterlagen enthalten sind, sind schematische Darstellungen. Gleiches gilt für digitale Medien wie CAD Dateien oder BIM Modelle.

Sie sollen den ausführenden Metallbauer und/oder Fachplaner bei der Planung und Ausführung eines Projektes unterstützen. Sie sind im konkreten Anwendungsfall durch den ausführenden Metallbauer und/oder Fachplaner auf die Verwendbarkeit im konkreten betroffenen Projekt hinsichtlich rechtlichen/regulatorischen aber auch technischen objektspezifischen Anforderungen zu überprüfen und ggfs. eigenverantwortlich anzupassen.

Bei der Überprüfung, der spezifischen Planung und der Umsetzung sind die objektspezifischen Rahmenbedingungen (Material der Bausubstanz, Dimension des Einbauelements, Farbe, Exposition, Lasteinwirkung, etc.) sowie der geltende Stand der Technik einschliesslich aller anwendbaren Normen und technischen Richtlinien eigenverantwortlich zu beachten.

Falls das vorliegende Dokument Differenzen zur aktuellen deutschen Version (Artikel Nr. K1214227) aufweist, gilt in jedem Fall der deutsche Originaltext in der jeweils geltenden Fassung im Jansen Docu Center.

Alle Ausführungen dieser Dokumentation haben wir sorgfältig und nach bestem Wissen zusammengestellt. Wir können aber keine Verantwortung für die Benutzung der vermittelten Vorschläge und Daten übernehmen. Wir behalten uns technische Änderungen ohne Vorankündigung vor.

Les données de planification graphiques, comme les exemples d'application, détails de construction et raccordements au bâtiment, fournies dans notre documentation physique et numérique sont des représentations schématiques. Il en va de même pour les médias numériques comme les fichiers CAD ou modèles BIM.

Leur but est de faciliter la planification et réalisation d'un projet par les constructeurs métalliques et/ou concepteurs. Concrètement, elles doivent être vérifiées par le constructeur métallique et/ou le concepteur et, le cas échéant, modifiées de son propre chef pour s'assurer qu'elles concordent avec le projet concerné et qu'elles répondent aux exigences techniques spécifiques ainsi qu'aux dispositions légales et réglementaires.

Lors de la vérification, de la planification spécifique et de la mise en œuvre, il y a lieu de tenir compte des conditions spécifiques à l'objet (matériaux du bâtiment, dimension de l'élément d'insert, couleur, exposition, effet de charge, etc.) ainsi que de l'état actuel de la technique, y compris toutes les normes et directives techniques applicables.

En cas de divergence entre le présent document et la version allemande (no d'article K1214227), c'est dans tous les cas le texte original allemand qui prévaut dans sa version actuelle disponible dans le Jansen Docu Center.

Nous avons apporté le plus grand soin à l'élaboration de cette documentation. Cependant, nous déclinons toute responsabilité pour l'utilisation faite de nos propositions et de nos données.

Nous nous réservons le droit de procéder à des modifications techniques sans préavis.

Graphical planning data such as application examples, construction details, connections on site that are contained in our physical or electronic documentation components are schematic representations. The same applies to digital media such as CAD files or BIM models.

They are intended to support the metal worker and/or design engineer in planning and executing projects. In the specific case of application they are to be checked by the metal worker and/or design engineer in terms of their usability in the specific project concerned with regard to legal/regulatory and technical property-specific requirements and adjusted if necessary at the latter's own responsibility.

The property-specific underlying conditions (construction material, dimensions of installation element, colour, exposure, load effect etc.) and current state of the art including all applicable norms and technical guidelines are to be taken into consideration at the metal worker and/or design engineer's own responsibility during the review, specific planning and implementation.

If there are any differences between this document and the current German version (item number K1214227), the latest version of the original German text in the Jansen Docu Center shall prevail.

All the information contained in this documentation is given to the best of our knowledge and ability. However, we decline all responsibility for the use made of these suggestions and data.

We reserve the right to effect technical modifications without prior warning.

Inhaltsverzeichnis		Jansen-Economy 60 RS	
Sommaire		Jansen-Economy 60 RS	
Content		Jansen-Economy 60 RS	

Systemübersicht	Sommaire du système	Summary of system	2
Merkmale Zulassungen Systemausführungen Typenübersicht	Caractéristiques Homologations Exécutions de système Sommaire des types	Characteristics Authorisations System versions Summary of types	

Profilsortiment	Assortiment de profilé	Range of profiles	12
------------------------	-------------------------------	--------------------------	-----------

Beispiele	Exemples	Examples	16
Schnittpunkte Konstruktionsdetails Anschlüsse am Bau	Coupes de détails Détails de construction Raccords au mur	Section details Construction details Attachment to structure	

Leistungseigenschaften	Caractéristiques de performance	Performance characteristics	28
-------------------------------	--	------------------------------------	-----------







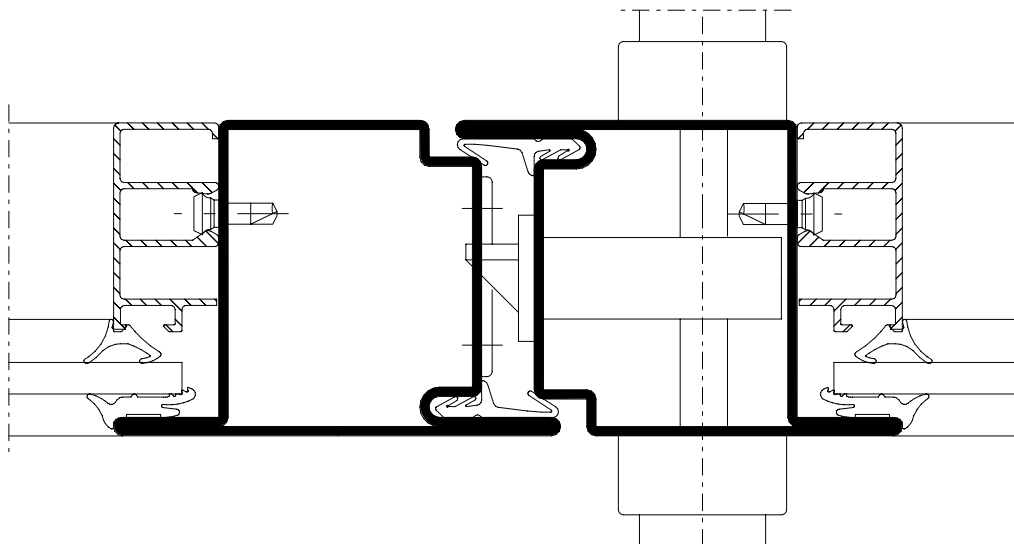

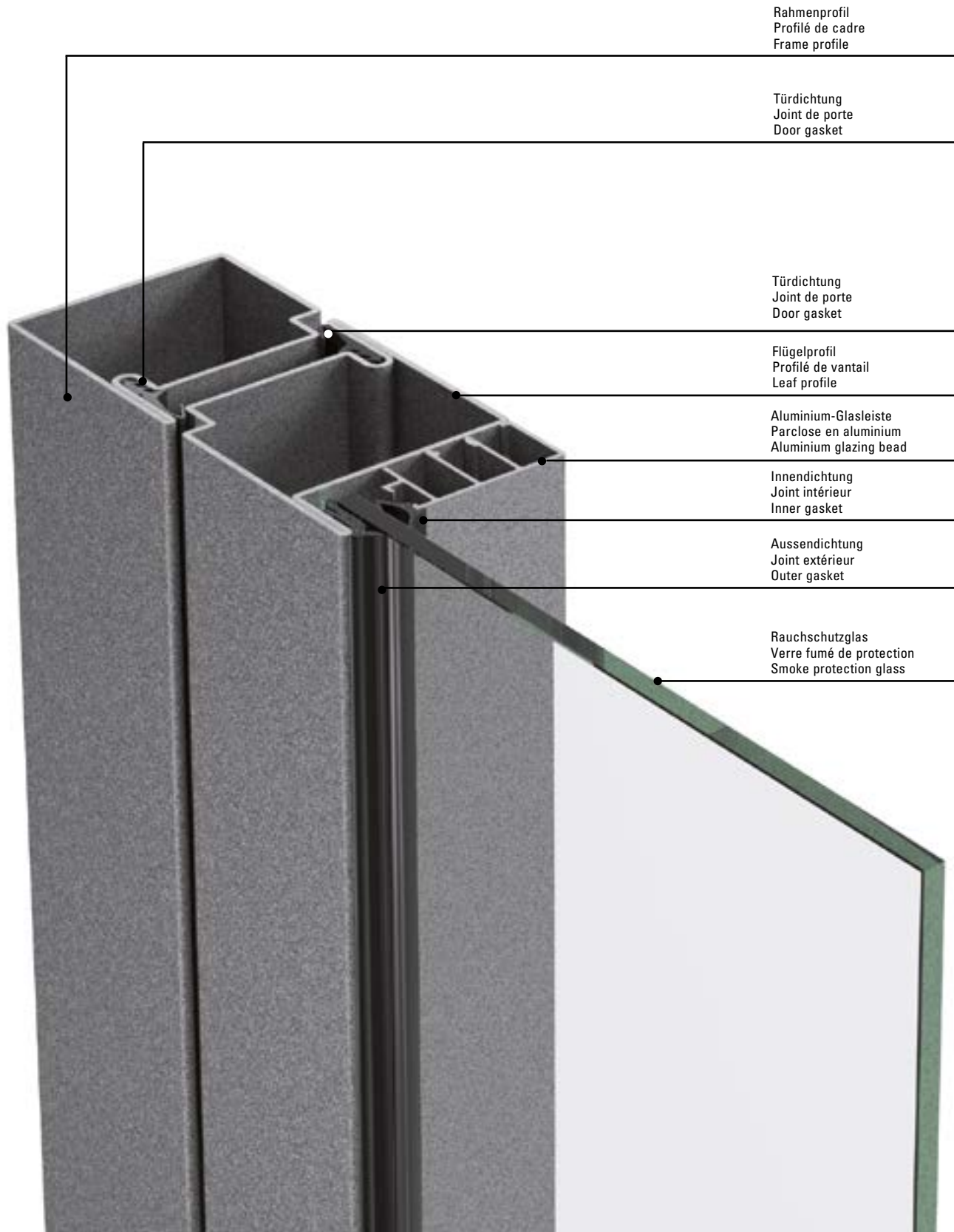

Merkmale
Caractéristiques
Characteristics





Jansen-Economy 60 RS
Jansen-Economy 60 RS
Jansen-Economy 60 RS

- Stahlsystem für Türen und Festverglasungen
 - Bautiefe 60 mm, innen und aussen flächenbündig
 - Schmale Ansichtsbreiten: Rahmen und Flügel ab 105 mm Stulppartie 150 mm
 - Ein- und zweiflüglige Türen, nach innen und aussen öffnend, mit oder ohne Seitenteile und Oberlichter sowie Trennwände
 - Türflügel bis 1750 x 3750 mm (BxH), landesspezifische Zulassung beachten
 - Füllelementstärke von 5 bis 26 mm, Glaseinbau mittels Trocken- oder Nassverglasung
 - Stahlprofile blank oder bandverzinkt
 - Grosses Sortiment an systemgeprüften Türbeschlägen
 - Barrierefreie Schwellenausbildungen
 - Geeignet für Pulver- und Nasslackbeschichtungen
 - Rauchschutztüre gemäss EN 1634-3 und EN 16034, Systemprüfungen nach Produktnorm EN 14351-1
 - Erscheinungsbild deckungsgleich mit anderen Jansen Brandschutzsystemen Jansen-Economy 50, Janisol 2 und Janisol C4
- Système en acier pour portes et vitrages fixes
 - Profondeur de montage 60 mm, montage à fleur à l'intérieur et à l'extérieur
 - Fines largeurs de face: Cadre et vantaux à partir de 105 mm Partie tête 150 mm
 - Portes à un et deux vantaux, ouverture vers l'intérieur et vers l'extérieur, combinables avec parties latérales, impostes et vitrage fixe
 - Vantaux de porte jusqu'à 1750 x 3750 mm (LaxH), il convient de respecter les prescriptions et règlements des divers pays concernés
 - Élément de remplissage de 5 à 26 mm d'épaisseur, Montage du vitrage à sec ou à silicone
 - Profilés en acier brut ou galvanisé en continu
 - Grand assortiment de ferrures de porte homologuées
 - Formes de seuil sans barrière
 - Convient aux revêtements par poudre ou peinture liquide
 - Porte coupe-fumée selon EN 1634-3 et EN 16034, contrôles des systèmes selon la norme produit EN 14351-1
 - Apparence égale comme les autres systèmes coupe-feu de Jansen (Jansen-Economy 50, Janisol 2 et Janisol C4)
- Steel system for doors and fixed glazing
 - 60 mm basic depth, flush-fitted on the inside and outside
 - Narrow face widths: Frame and leaf from 105 mm Meeting stile assembly 150 mm
 - Single and double-leaf doors, inward and outward-opening, can be combined with side-lights, toplight or fixed glazing
 - Door leaf up to 1750 x 3750 mm (WxH), the regulations and bye-laws in force in the particular country must be respected
 - Infill unit thickness of 5 to 26 mm, Glazing installed by means of dry or wet glazing
 - Raw finish or strip galvanised steel profiles
 - Large range of system-tested door fittings
 - Easy-access thresholds
 - Suitable for powder and wet paint coating
 - Smoke-proof door according to EN 1634-3 and EN 16034, system tests in accordance with EN 14351-1
 - Same appearance as the other Jansen fire-resistant systems Jansen-Economy 50, Janisol 2 and Janisol C4





Norm	Eigenschaft Caractéristique Characteristic	Klassifizierung/Wert Classification / Valeur Classification / Value										
		npd	1 (400)	2 (800)	3 (1200)	4 (1600)	5 (2000)	Exxx (>2000)				
 EN 12210	Widerstandsfähigkeit bei Windlast Résistance à la pression du vent Resistance to wind load	npd	1 (400)	2 (800)	3 (1200)	4 (1600)	5 (2000)	Exxx (>2000)				
 EN 12208	Schlagregendichtheit Etanchéité à la pluie battante Watertightness	npd	1A (0)	2A (50)	3A (100)	4A (150)	5A (200)	6A (250)	7A (300)	8A (450)	9A (600)	Exxx (>750)
 EN ISO 10140	Schalldämmung R_w (C, C_{tr}) (dB) Isolation phonique R_w (C, C_{tr}) (dB) Sound insulation R_w (C, C_{tr}) (dB)	npd	bis R_w 44 dB (-2; -5) jusqu'à R_w 44 dB (-2; -5) up to R_w 44 dB (-2; -5)									
 EN ISO 10077-2	Wärmedurchgangskoeffizient U_f (W/(m ² ·K)) Transmission thermique U_f (W/(m ² ·K)) Thermal production U_f (W/(m ² ·K))	npd	ab 5.65 W/m ² K à partir de 5.65 W/m ² K from 5.65 W/m ² K									
 EN 12207	Luftdurchlässigkeit Perméabilité à l'air Air permeability	npd	1 (150)		2 (300)		3 (600)		4 (600)			
 EN 1192	Klassifizierung der Festigkeitsanforderungen Classification des exigences de résistance méc. Classification of strength requirements	npd	1		2		3		4			
 EN 1627	Einbruchhemmung Anti-effraction Burglar resistance	npd	1		2		3		4		5	6
 EN 1522	Durchschusshemmung Résistance aux balles Bullet proofing	npd	FB1	FB2	FB3	FB4	FB5	FB6	FB7	FSG		
 EN 1191 EN 1603	Dauerfunktionsprüfung Durabilité mécanique Mechanical durability		D 1 5'000	2 10'000	3 20'000	4 50'000	5 100'000	6 200'000	7 500'000	8 1'000'000		
 EN 179 EN 1125	Fähigkeit zur Freigabe Capacité au déclenchement Ability to release		Anforderung erfüllt Exigence remplie Requirement fulfilled									

Norm	Eigenschaft Caractéristique Characteristic	Klassifizierung/Wert Classification / Valeur Classification / Value			
 EN 12217	Bedienkräfte Forces de manœuvre Operating forces	npd	0	1	2
 EN 1634-3	Rauchschutz Etanchéité à la fumée Smoke control		S _a / S ₂₀₀		
 EN 16034 EN 13501-2	Selbstschliessung Fermeture automatique Self-closing		C		
 EN 16034	Dauerhaftigkeit der Selbstschliessung gegenüber Alterung (Korrosion) Endurance de la fermeture automatique contre le vieillissement (corrosion) Durability of self-closing against ageing (corrosion)		erzielt atteinte achieved		



Fluchttürsysteme

- Fluchttürsysteme geeignet für Notausgänge und Paniktüren
- Fluchttürnorm EN 179 für Notausgangsverschlüsse erfüllt
- Fluchttürnorm EN 1125 für Panikverschlüsse erfüllt

Systèmes de porte de secours

- Systèmes de porte de secours pour issues de secours et portes panique
- Norme relative aux portes de secours EN 179, remplie pour les fermetures d'issue de secours
- Norme relative aux portes de secours EN 1125, remplie pour les fermetures panique

Emergency exit systems

- Emergency exit systems suitable for emergency exits and panic doors
- Emergency exit standard EN 179 for emergency exit devices fulfilled
- Emergency exit standard EN 1125 for panic exit devices fulfilled



Einbruchhemmende Jansen-Economy 60 RS Türen

- Türgrößen bis 1475 x 3000 mm
- Ein- und zweiflüglige Türen, nach innen und aussen öffnend
- Normal- und Panikfunktion bis RC3
- Geprüft nach EN 1627

Portes anti-effraction Jansen-Economy 60 RS

- Dimensions de porte jusqu'à 1475 x 3000 mm
- Portes à un/deux vantaux ouvrant vers l'intérieur et l'extérieur
- Fonction normale et fonction panique jusqu'à RC3
- Contrôlé selon la norme EN 1627

Burglar-resistant Jansen Economy 60 RS doors

- Door sizes up to 1475 x 3000 mm
- Single and double-leaf doors, inward and outward-opening
- Standard and panic function up to RC3
- Tested in accordance with EN 1627



Verblechte Jansen-Economy 60 RS Türen

- Für ein- und zweiflügelige Brandschutztüren mit oder ohne Seitenteile resp. Oberlichter
- Flächenbündig verblechte Türen
- Bleche können an den Rahmen geschweisst oder geklebt werden
- Mit oder ohne Glasausschnitte möglich

Portes tôlées Jansen-Economy 60 RS

- Pour des portes coupe-feu à un/deux vantaux avec ou sans pièces latérales ou impostes
- Portes tôlées à fleur
- Les tôles peuvent être soudées ou collées sur le cadre
- Possibles avec ou sans panneaux de verre

Jansen Economy 60 RS sheet metal doors

- For single and double-leaf fire doors with or without sidelights or toplights
- Flush-fitted sheet metal doors
- Sheet metal can be welded or bonded to the frame
- Possible with or without glass vision panels

Jansen Docu Center

Die Plattform zum effizienten Arbeiten mit Jansen Dokumentationen. Im Jansen Docu Center stehen alle Produktinformationen jederzeit digital in der aktuellsten Version zur Verfügung: von Architekten-Informationen über Bestell- und Fertigungskatalogen bis hin zu Anleitungen und Prospekten sowie Videos.

Die Inhalte können einfach und schnell aufgerufen werden. Ein für den Anwender komfortables papierloses Arbeiten, das zahlreiche Vorteile bietet.

Download CAD Daten

DXF

DWG

Sie können die Zeichnungen in den Formaten DXF und/oder DWG herunterladen. Klicken Sie auf das entsprechende Icon und der Download erfolgt.

Die Hinweise «Artikelbibliothek/Türbeschläge/Fensterbeschläge» bedeuten, dass Sie mit einem Klick die gesamte Artikelbibliothek des entsprechenden Systems herunterladen (Profile, Beschläge, Glasleisten, Zubehör etc.).

Info und Beratung

Gerne beraten wir Sie persönlich und stehen Ihnen bei Fragen zur Verfügung. Bitte schreiben Sie uns Ihre Anliegen an: info@jansen.com

Jansen Docu Center

La plate-forme pour travailler efficacement avec les documentations Jansen. Le Jansen Docu Center met à votre disposition les informations sur les produits, en format numérique et dans une version actualisée: des catalogues de commande et de fabrication aux instructions et prospectus, en passant par les informations destinées aux architectes et vidéos.

Les contenus sont facilement et rapidement accessibles. Une manière de travailler confortable et offrant de nombreux avantages.

Télécharger fichiers DAO

DXF

DWG

Vous pouvez télécharger les dessins aux formats DXF et/ou DWG. Cliquez sur l'icône correspondante et le téléchargement s'effectuera.

Les indications «Bibliothèque des articles/Ferures de porte/Ferrures de fenêtres» signifie que vous téléchargez la totalité de la bibliothèque des articles du système donné (profilés, ferrures, parcloles, accessoires etc.).

Info et conseils

Nous vous conseillons volontiers individuellement et sommes à votre disposition si vous avez des questions à poser. Veuillez nous envoyer votre requête à: info@jansen.com

Jansen Docu Center

The platform for working efficiently with Jansen documentation. The latest version of all the product information is available digitally at any time in the Jansen Docu Center – from order and fabrication manuals to architect information, instructions and brochures and videos.

The content can be retrieved quickly and easily. The user can work conveniently without paper, which has numerous benefits.

Download CAD files

DXF

DWG

You can download the drawings in DXF and/or DWG format. Click on the relevant icon to begin the download.

The items «Article library/Door fittings/Window fittings» means that you download the entire article library for the corresponding system with one click (profiles, fittings, glazing beads, accessories etc.).

Information and advice

We would be delighted to provide you with advice in person and are available to answer any questions you may have. Please write to us with your queries at: info@jansen.com

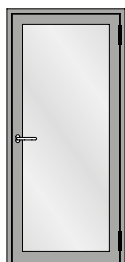

Einflügelige Türe
 Porte à un vantail
 Single leaf door

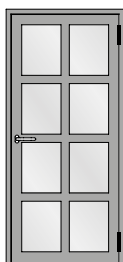

Einflügelige Türe mit Riegel
 Porte à un vantail avec traverse
 Single leaf door with transom

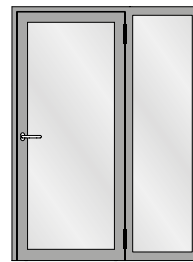

Einflügelige Türe mit festem Seitenteil
 Porte à un vantail avec partie latérale fixe
 Single leaf door with fixed side light

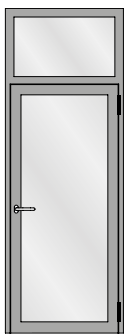

Einflügelige Türe mit festem Oberlicht
 Porte à un vantail avec imposte fixe
 Single leaf door with fixed top light

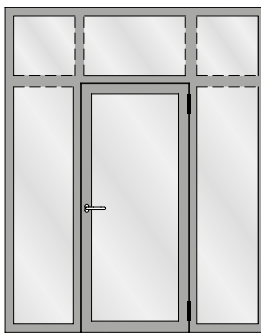

Einflügelige Türe mit zwei festen Seitenteilen
 und festem Oberlicht
 Porte à un vantail avec deux parties latérale fixe
 et imposte fixe
 Single leaf door with two fixed side light and
 fixed top light

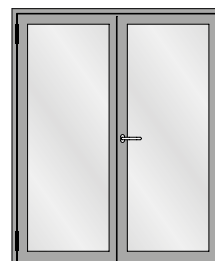

Zweiflügelige Türe
 Porte à deux vantaux
 Double leaf door



Zweiflügelige Türe mit zwei festen Seitenteilen
 Porte à deux vantaux avec deux parties
 latérales fixes
 Double leaf door with two fixed side lights

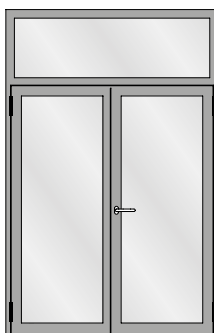

Zweiflügelige Türe mit festem Oberlicht
 Porte à deux vantaux avec imposte fixe
 Double leaf door with fixed top light

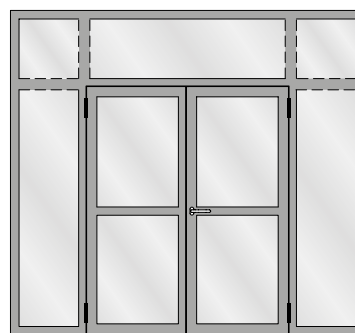

Zweiflügelige Türe mit zwei festen Seitenteilen
 und festen Oberlichtern
 Porte à deux vantaux avec deux parties latérales
 fixes et impostes fixes
 Double leaf door with two fixed side lights and
 fixed top lights

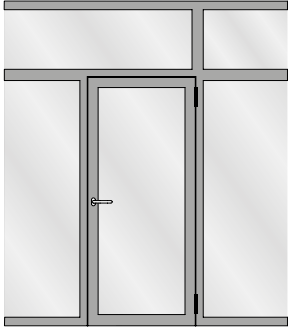

Festverglasung mit einflügeliger Türe
Vitrage fixe avec porte à un vantail
Fixed glazing with single leaf door

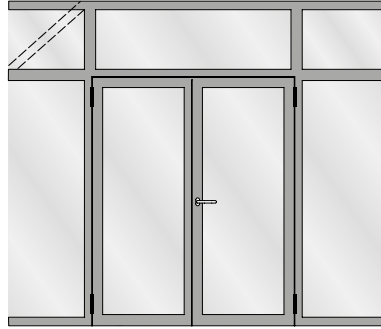

Festverglasung mit zweiflügeliger Türe
Vitrage fixe avec porte à deux vantaux
Fixed glazing with double leaf door

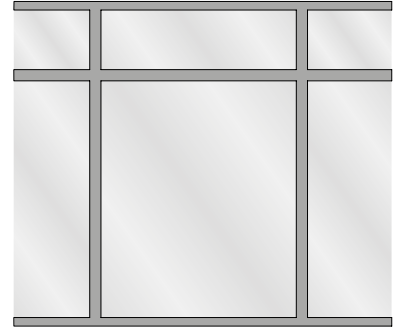

Festverglasung
Vitrage fixe
Fixed glazing

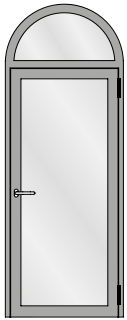

Einflügelige Türe mit Rundbogen-Oberlicht
Porte à un vantail avec imposte demi-ronde
Single leaf door with round arched top light

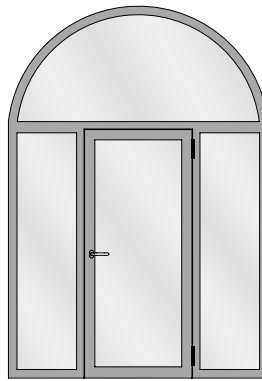

Einflügelige Türe mit zwei festen Seitenteilen
und Rundbogen-Oberlicht
Porte à un vantail avec deux parties latérales
fixes et imposte demi-ronde
Single leaf door with two fixed side lights and
round arched top light

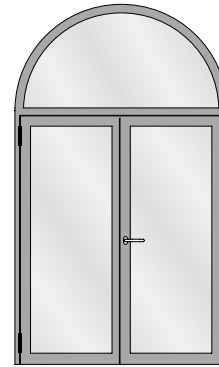

Zweiflügelige Türe mit Rundbogen-Oberlicht
Porte à deux vantaux avec imposte demi-ronde
Double leaf door with round arched top light

**Für Festverglasungen gelten
nationale Zulassungen.**

**Les homologations nationales
s'appliquent aux vitrages fixes.**

**National approvals apply to fixed
glazing.**

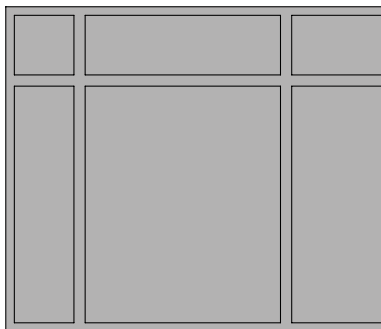
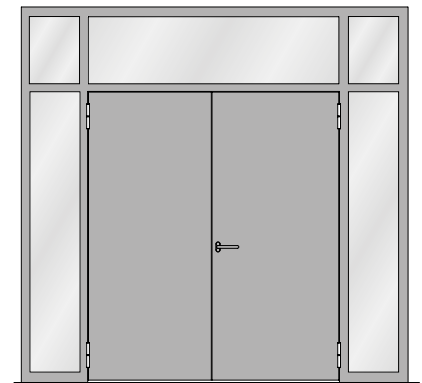
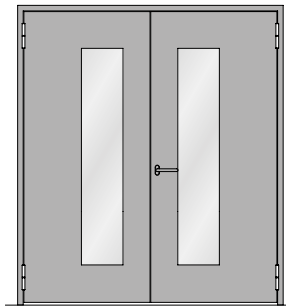
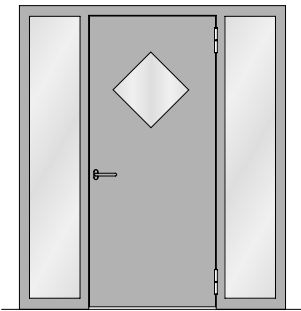
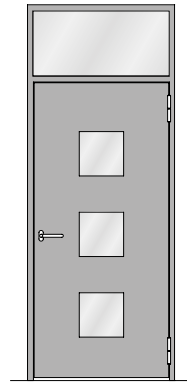
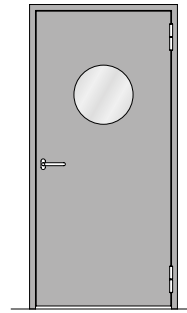
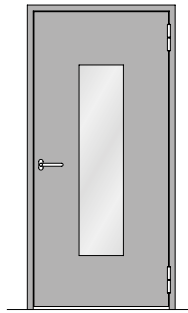
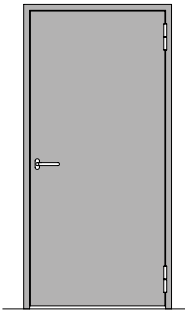

Für Festverglasungen gelten nationale Zulassungen.

Les homologations nationales s'appliquent aux vitrages fixes.

National approvals apply to fixed glazing.

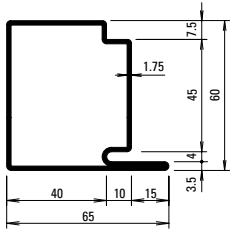

30.019
30.019 Z

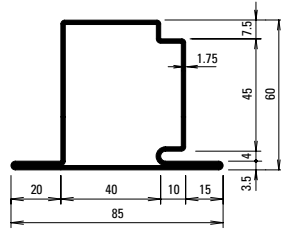

30.119
30.119 Z

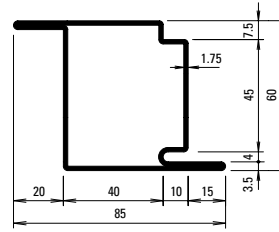

30.419
30.419 Z

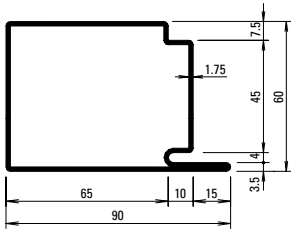

30.017
30.017 Z

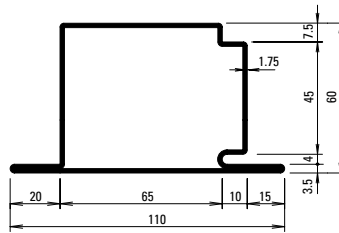

30.117
30.117 Z

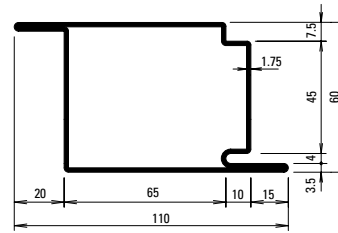

30.415

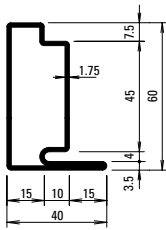

30.018
30.018 Z

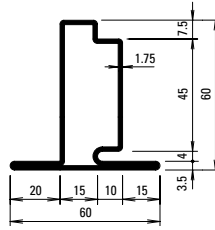

30.118
30.118 Z

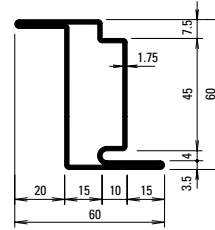

30.418
30.418 Z

Oberfläche/Werkstoff

Artikel-Nr.

ohne Zusatz = blank

mit Z = bandverzinkter Stahl

Surface/Matériau

No. d'article

sans supplément = brut

avec Z = bande d'acier zinguée

Surface/Material

Part no.

without addition = bright

with Z = strip galvanised steel

Profil-Nr.	G kg/m	F cm ²	I _x cm ⁴	W _x cm ³	I _y cm ⁴	W _y cm ³	U m ² /m
30.017	4,190	5,33	31,17	9,04	48,34	10,30	0,310
30.018	2,830	3,61	15,96	4,36	4,77	1,93	0,212
30.019	3,517	4,48	23,69	6,71	19,75	5,56	0,262
30.117	4,746	6,05	34,81	9,37	65,86	11,54	0,351
30.118	3,364	4,29	18,64	4,65	8,62	2,76	0,250
30.119	3,486	4,44	23,36	6,08	25,26	5,70	0,301

Profil-Nr.	G kg/m	F cm ²	I _x cm ⁴	W _x cm ³	I _y cm ⁴	W _y cm ³	U m ² /m
30.415	4,746	6,04	37,87	12,33	65,86	11,54	0,351
30.418	3,364	4,29	22,93	7,37	8,62	2,76	0,250
30.419	3,486	4,44	26,49	8,57	25,26	5,70	0,301

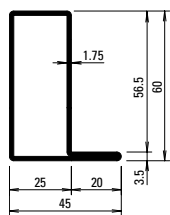

01.634
01.634 Z

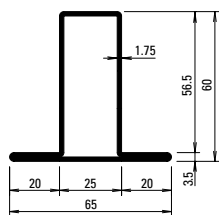

02.634
02.634 Z

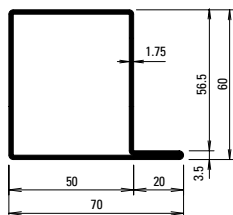

01.684
01.684 Z

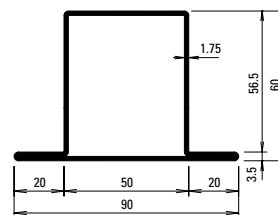

02.684
02.684 Z

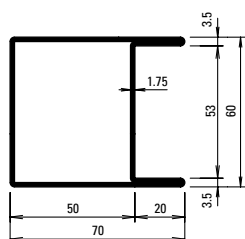

04.637
04.637 Z

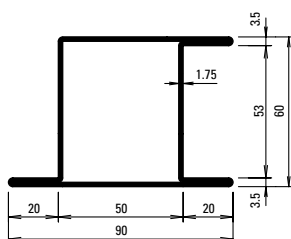

05.637
05.637 Z

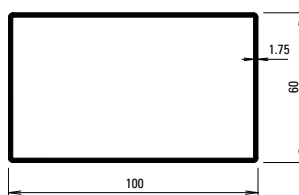

400.051
400.051 Z

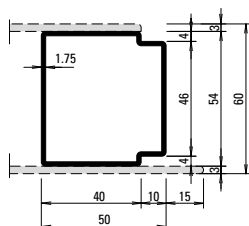

81.010 Z

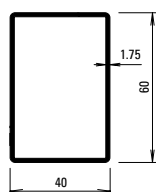

400.052
400.052 Z

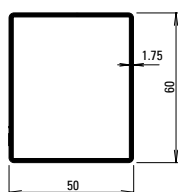

400.054
400.054 Z

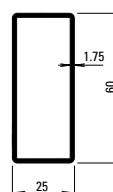

400.055
400.055 Z

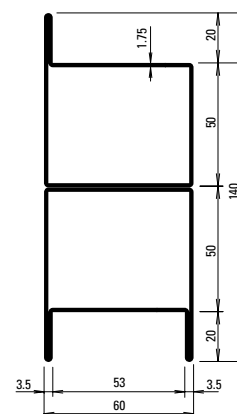

05.001

Profil-Nr.	G kg/m	F cm ²	I _x cm ⁴	W _x cm ³	I _y cm ⁴	W _y cm ³	U m ² /m
01.634	2,729	3,48	16,56	4,66	6,01	2,14	0,204
02.634	3,266	4,16	19,52	4,96	10,33	3,18	0,243
01.684	2,948	3,76	21,13	6,13	19,15	4,84	0,255
02.684	3,412	4,35	24,14	6,41	27,64	6,14	0,294
04.637	3,960	5,05	30,63	10,21	27,46	7,72	0,294
05.637	3,875	4,94	30,92	9,26	34,14	6,94	0,334
81.010	2,696	3,44	14,54	5,38	13,06	5,11	0,202
400.051	4,272	5,44	34,64	11,55	76,01	15,20	0,317
400.052	2,627	3,35	16,87	5,62	8,99	4,49	0,197
400.054	2,901	3,70	19,84	6,61	14,97	5,99	0,217
400.055	2,214	2,82	12,41	4,14	3,09	2,47	0,167

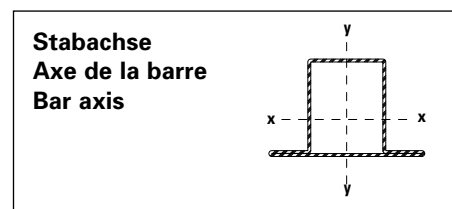

Artikelbibliothek
 Bibliothèque des articles
 Article library

DXF **DWG**

Bogentüren
Portes cintrées
Arched doors

Jansen-Economy 60 RS
 Jansen-Economy 60 RS
 Jansen-Economy 60 RS

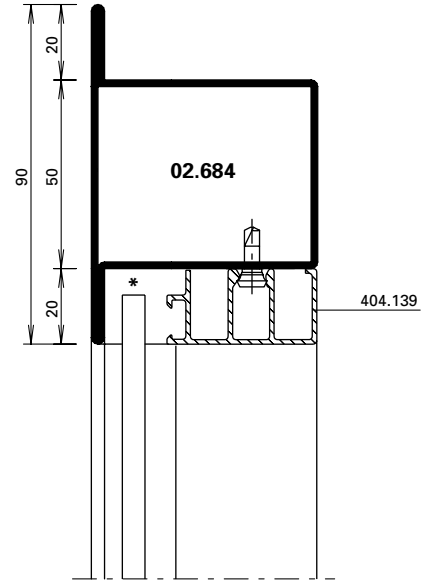
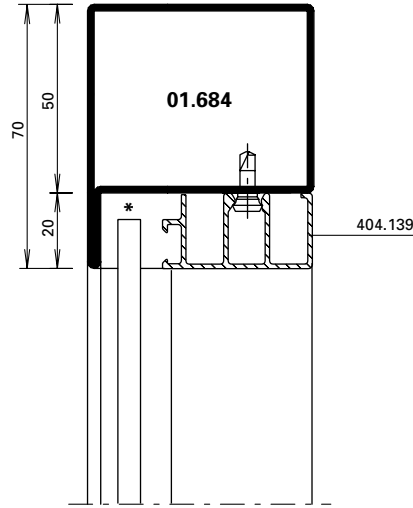
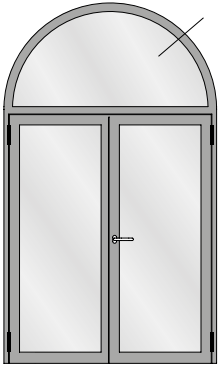

* Füllelemente mit rauchdichtem dauerelastischem Dichtstoff (z.B. 450.092) vollständig in den Glasfalzgrund einkleben.

* Coller entièrement les éléments de remplissage avec produit d'étanchéité à l'élasticité permanente (p.ex. 450.092) dans la feuillure en verre.

* Infill panels with smoke-tight, permanently flexible sealant (e.g. 450.092) fully glued into the glazing rebate platform.

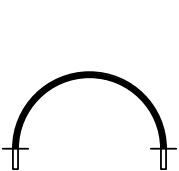

Halbrundbogen
 Arc semi-circulaire
 Semi-circular arch

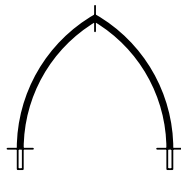

Spitzbogen
 Arc en ogive
 Gothic arch



Stichbogen
 Arc bombé
 Segmented arch



Korbbogen
 Anse de panier
 Oval arch

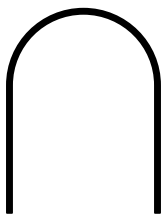

Halbrundbogen mit Schenkel
 Arc surhaussé prolongée
 Semi-circular arch with side extension

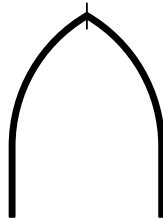

Spitzbogen mit Schenkel
 Arc en ogive prolongée
 Gothic arch with side extension

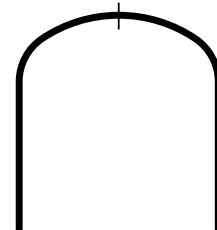



Korbbogen mit Schenkel
 Anse de panier prolongée
 Oval arch with side extension

Bogentüren
Portes cintrées
Arched doors

Jansen-Economy 60 RS
 Jansen-Economy 60 RS
 Jansen-Economy 60 RS

Profil Profilé Profile	Min. Radius Rayon min. Min. radius R	blank brut bright	verzinkt zinguée galvanised
		mm	mm
01.634	550	550	
01.684	650	650	

		mm	mm
02.634	600	650	
02.684	1050	1050	

		mm	mm
04.637	1550	1550	

		mm	mm
05.637	1550	1550	

		mm	mm
400.052	1100	1100	
400.054	1000	1000	
400.055	800	800	
81.010		800	

Profil Profilé Profile	Min. Radius Rayon min. Min. radius R	blank brut bright	verzinkt zinguée galvanised
		mm	mm
30.018			550
30.019	650	650	

		mm	mm
30.118	800	800	
30.119	900	900	

		mm	mm
30.418	800	800	
30.419	1100	1100	

Stahl-Glasleisten Parcloses en acier Steel glazing beads	Min. Radius Rayon min. Min. radius R
--	---

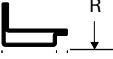
		mm
62.507 Z	300	mm
62.508 Z	300	mm
62.509 Z	300	mm

Stahl-Glasleisten Parcloses en acier Steel glazing beads	Min. Radius Rayon min. Min. radius R	
		mm
402.112 Z	500	mm
402.115 Z	500	mm
402.120 Z	600	mm
402.125 Z	750	mm
402.130 Z	1000	mm
402.135 Z	1500	mm

Aluminium-Glasleisten Parcloses en aluminium Aluminium glazing beads	Min. Radius Rayon min. Min. radius R
--	---

		mm
404.109	400	mm
404.112	400	mm
404.115	400	mm
404.120	400	mm
404.125	450	mm
404.130	500	mm
404.135	600	mm

		mm
405.110	500	mm
405.115	500	mm
405.120	500	mm
405.125	800	mm
405.130	1000	mm
406.903	500	mm
406.905	500	mm
406.907	500	mm
406.909	600	mm

Die Radien-Angaben beziehen sich auf die langjährige Erfahrung und Fertigung im Hause Jansen.

Les rayons indiqués se fondent sur la longue expérience et la fabrication au sein de la maison Jansen.

The radii specifications are based on the many years of experience Jansen has in fabrication.

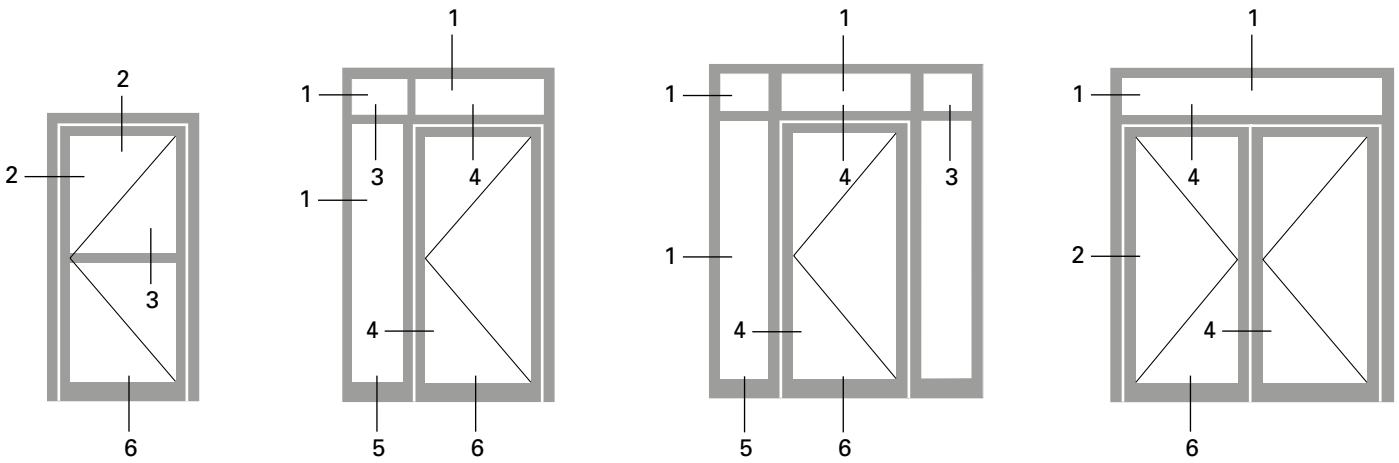

3.0

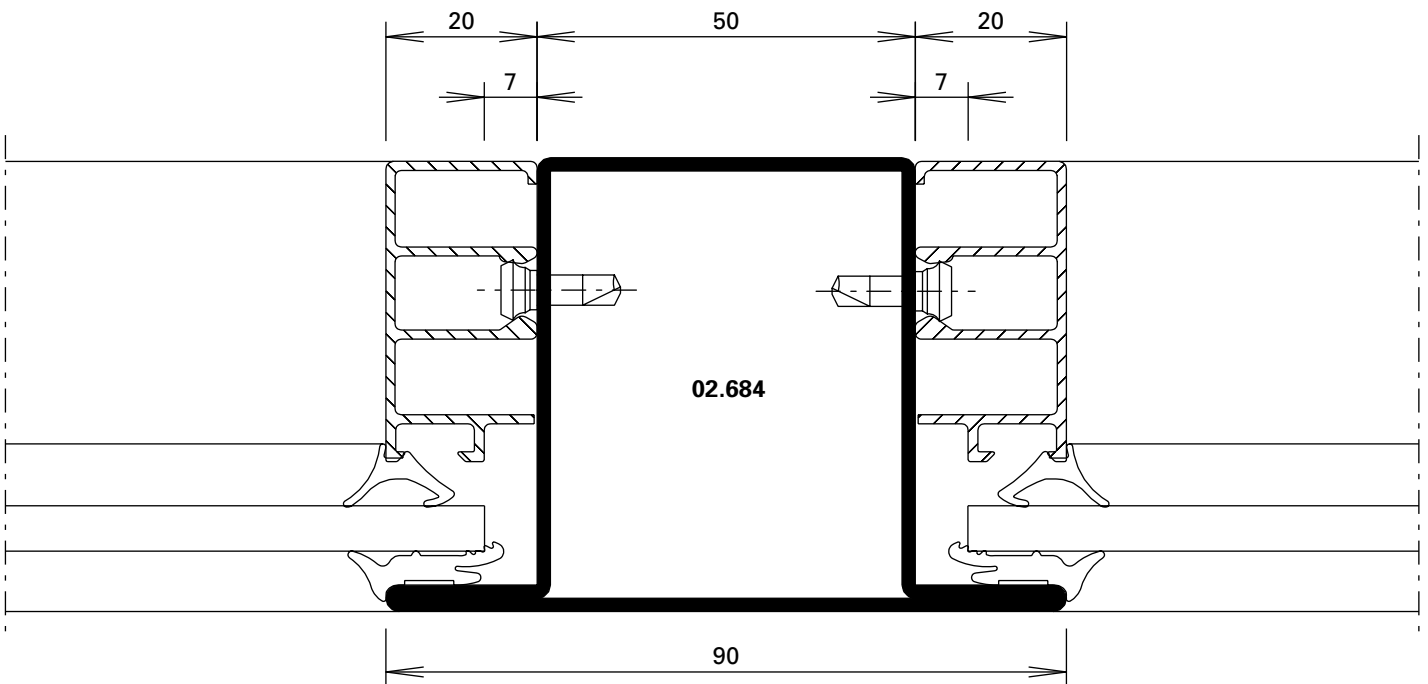

DXF DWG 41-0301-C-007

2.0

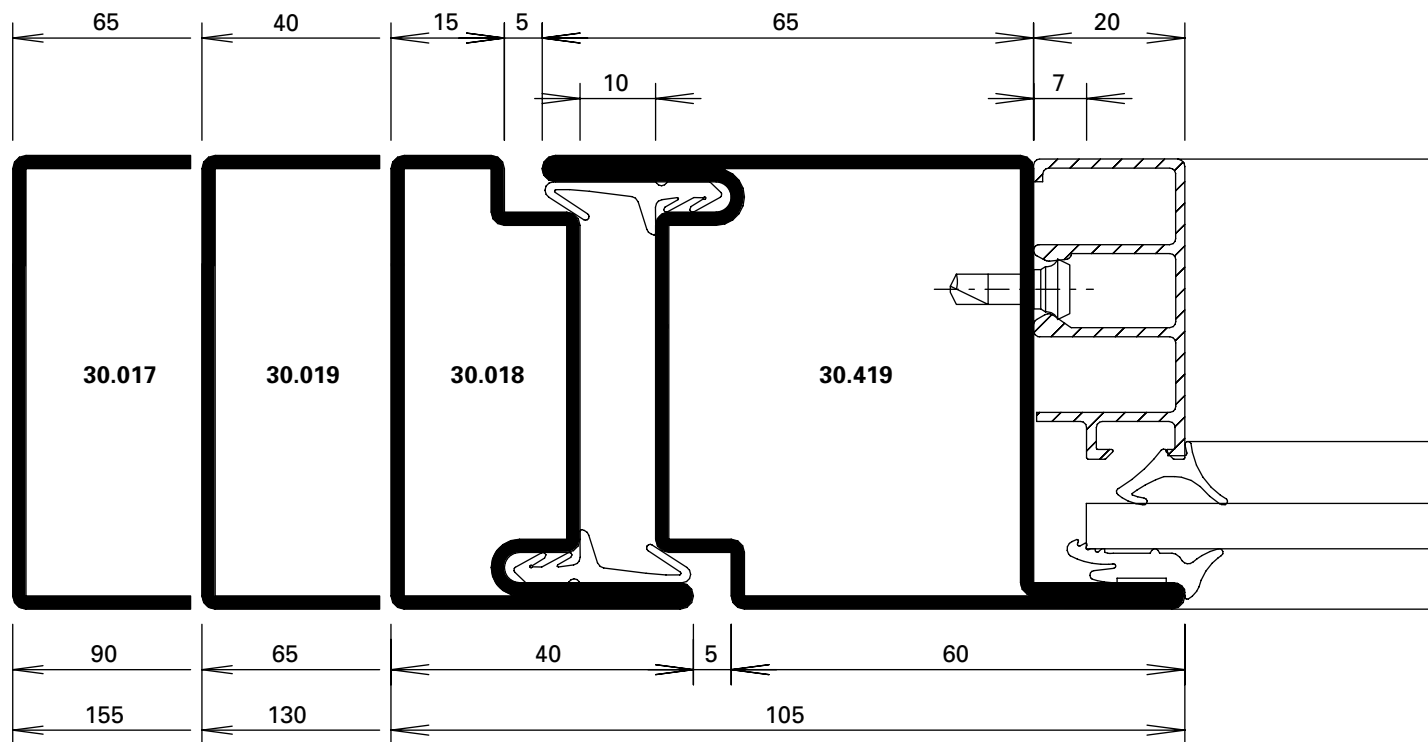

DXF **DWG** 41-0301-C-004

4.0

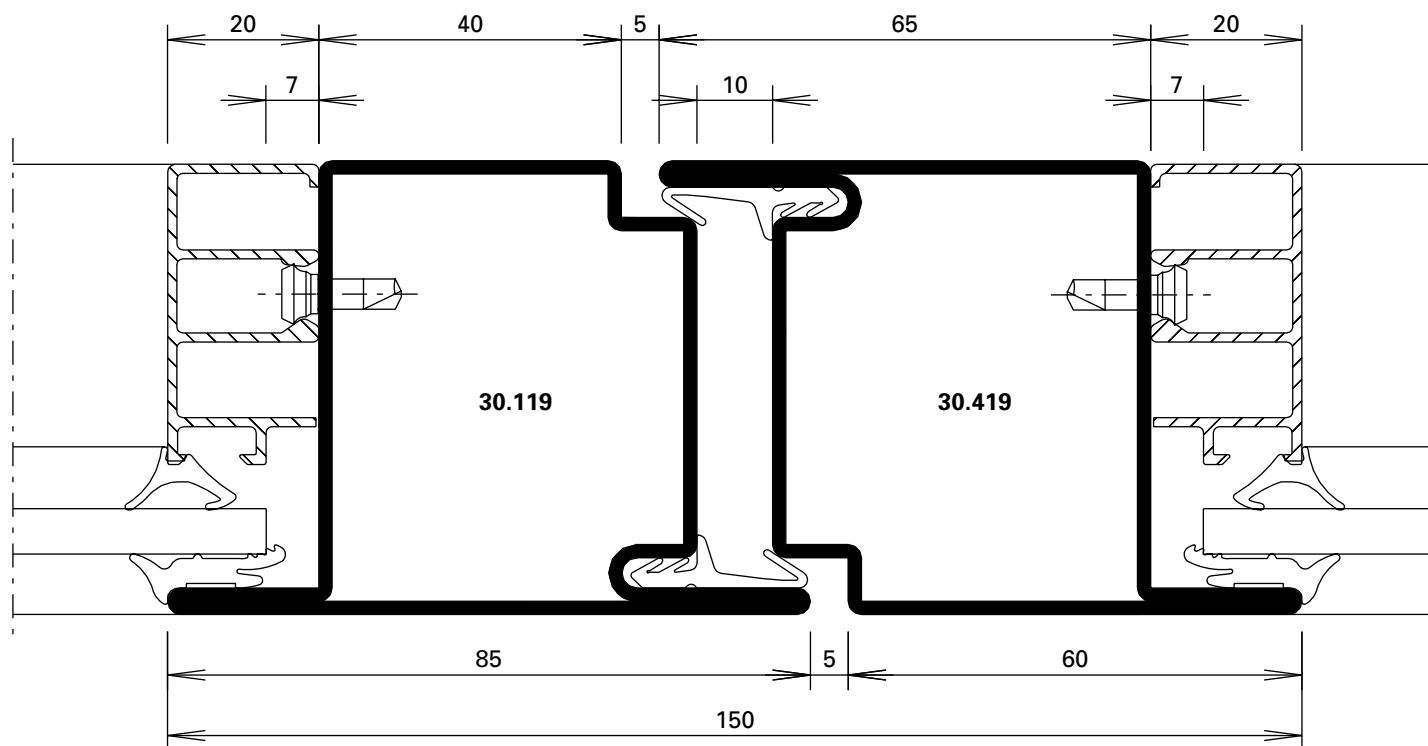

DXF **DWG** 41-0301-C-008

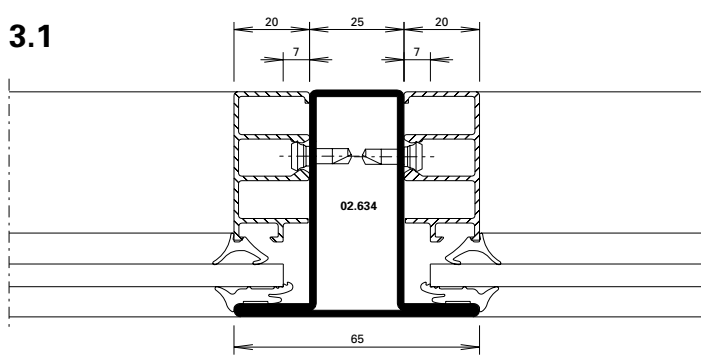
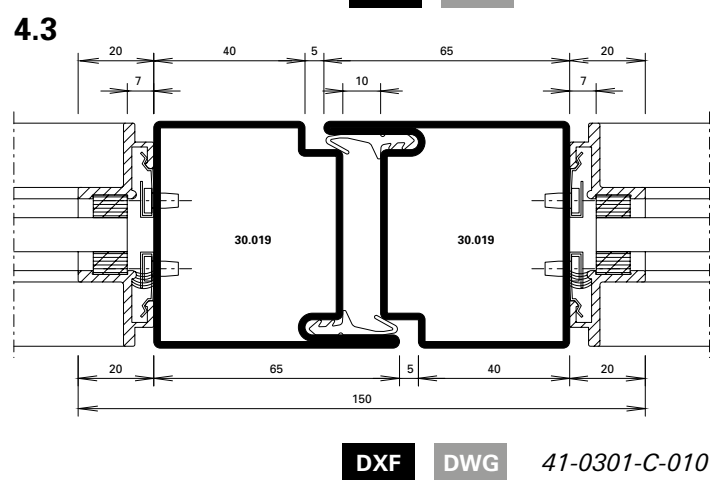
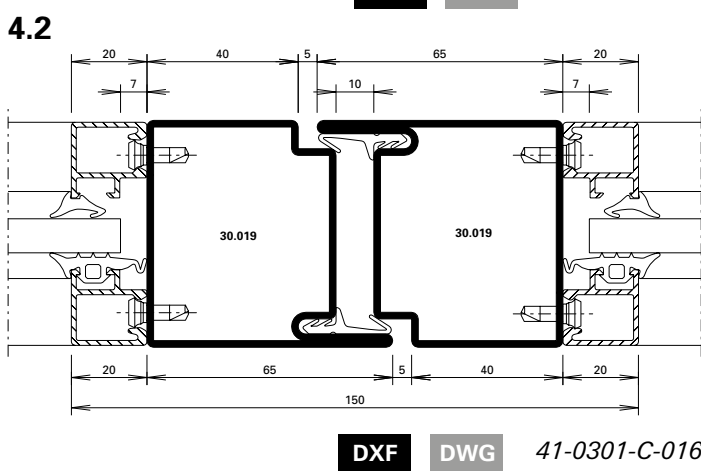
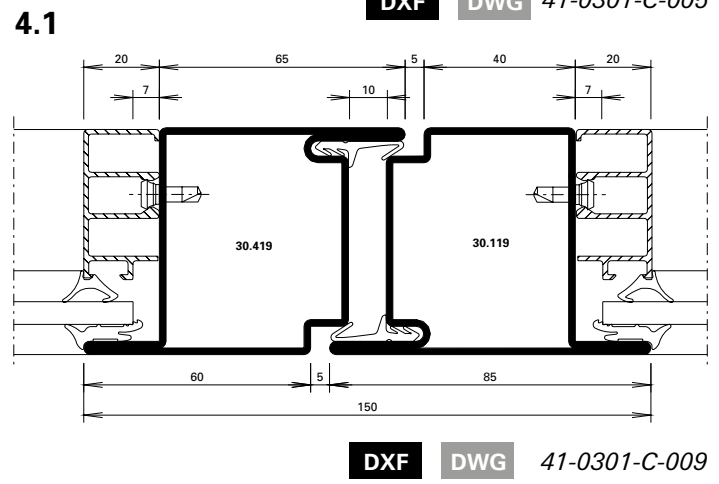
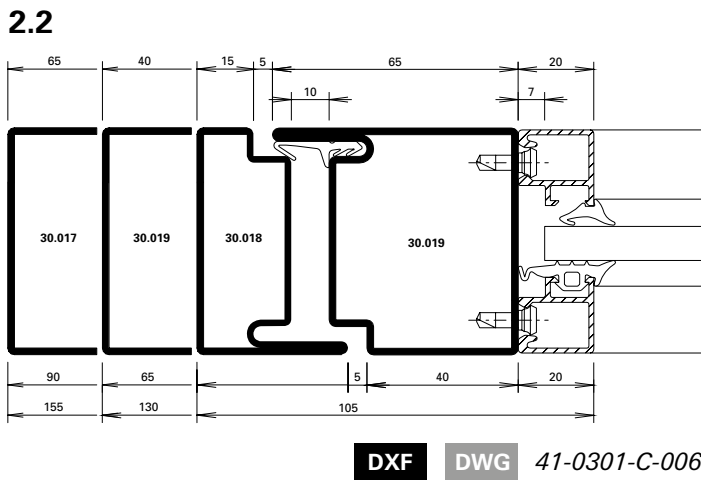
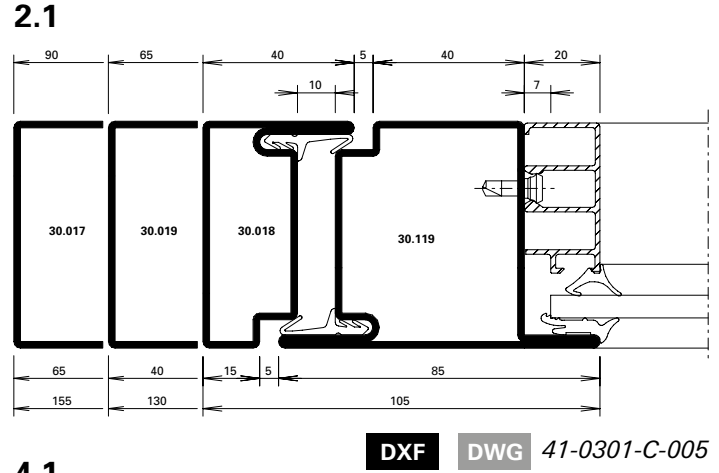
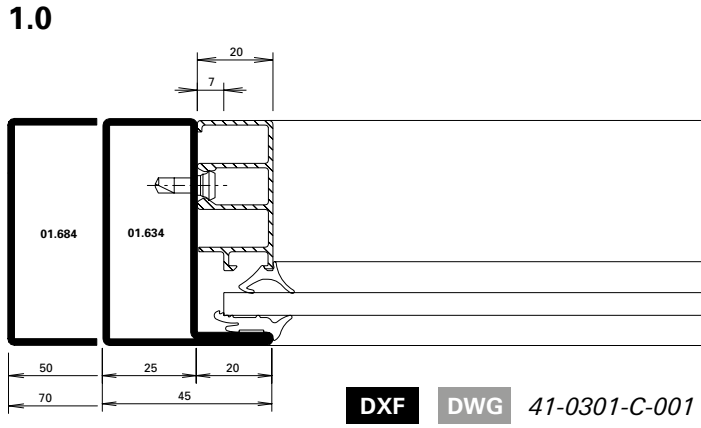

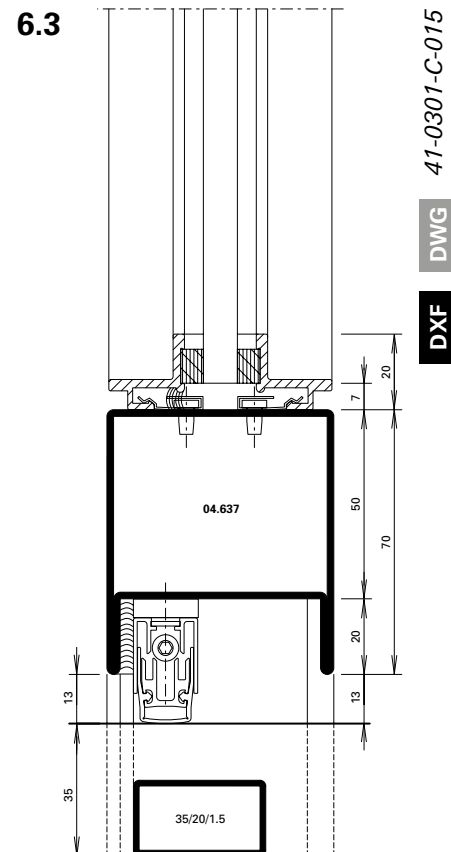
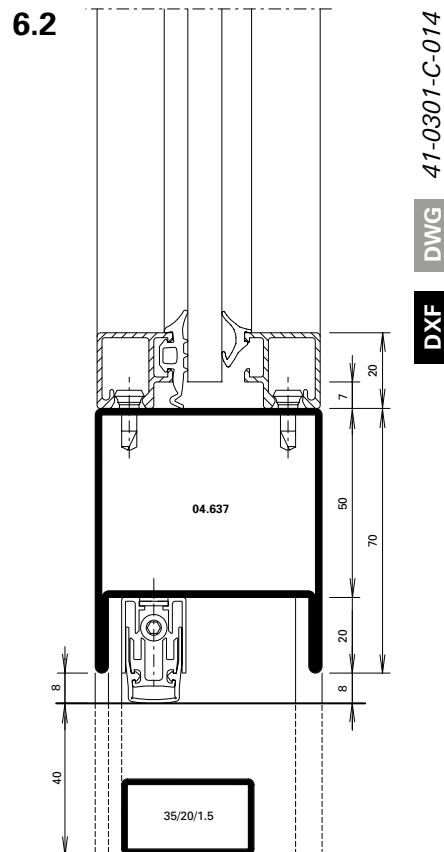
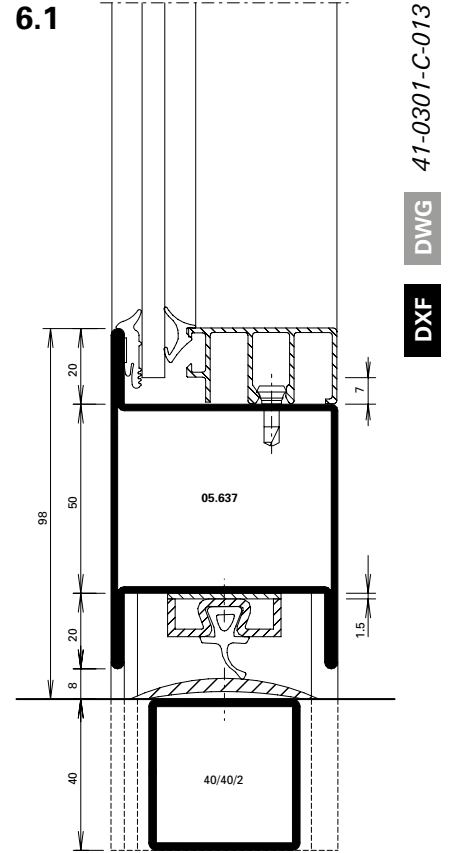
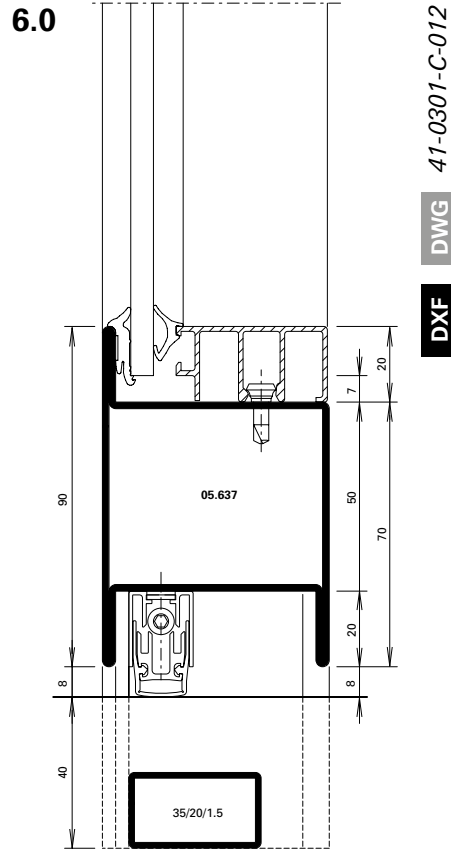
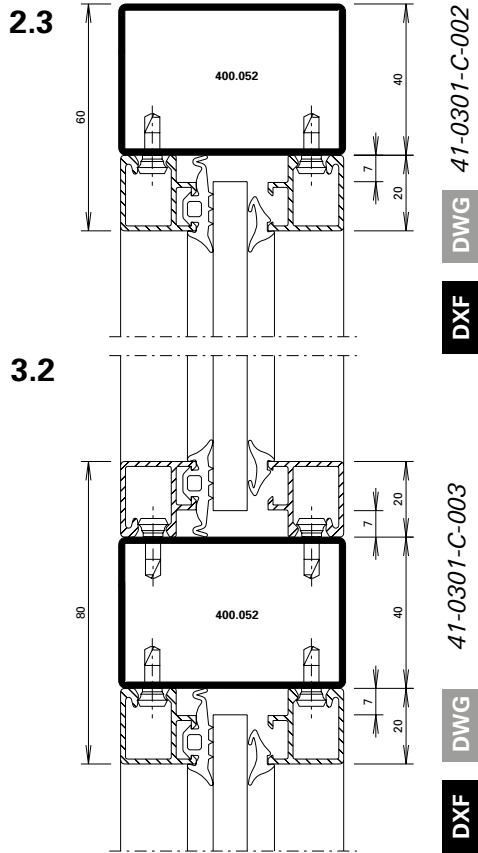

Glasleisten-Varianten im Masstab 1:2
Variantes de parcloses à l'échelle 1:2
Glazing bead options on scale 1:2

Jansen-Economy 60 RS
 Jansen-Economy 60 RS
 Jansen-Economy 60 RS

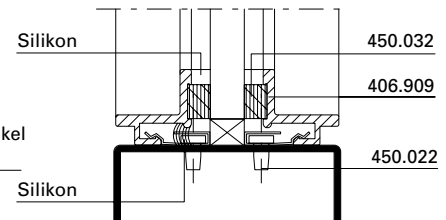
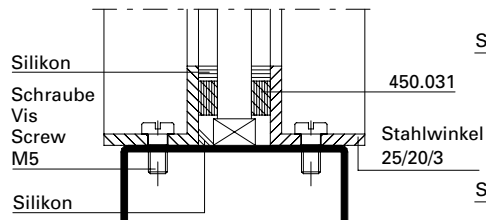
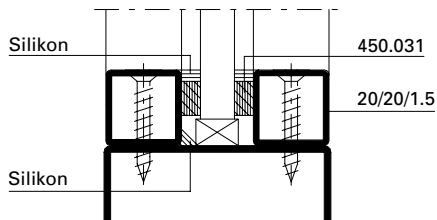
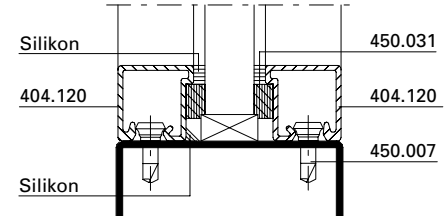
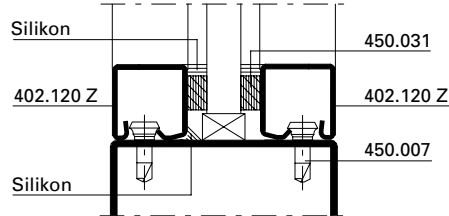
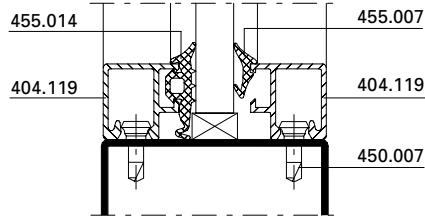
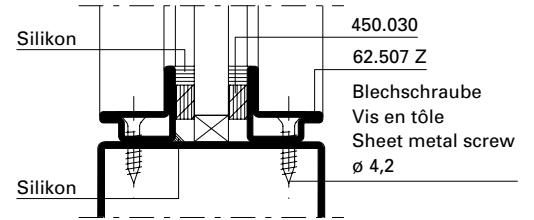
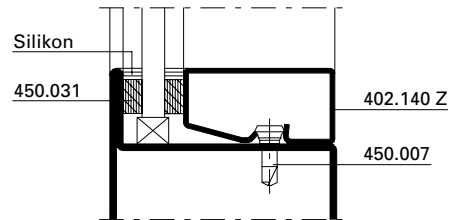
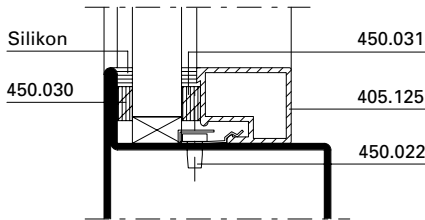
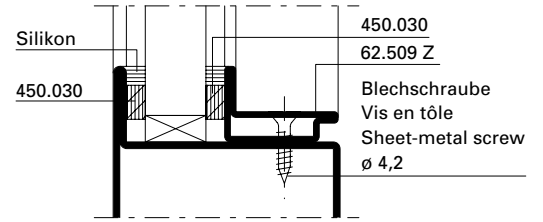
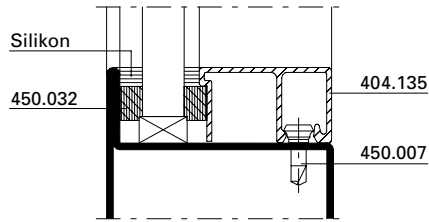
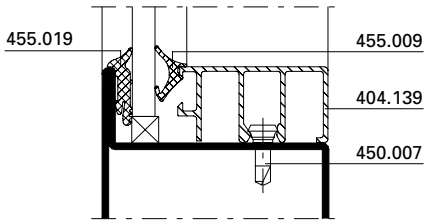

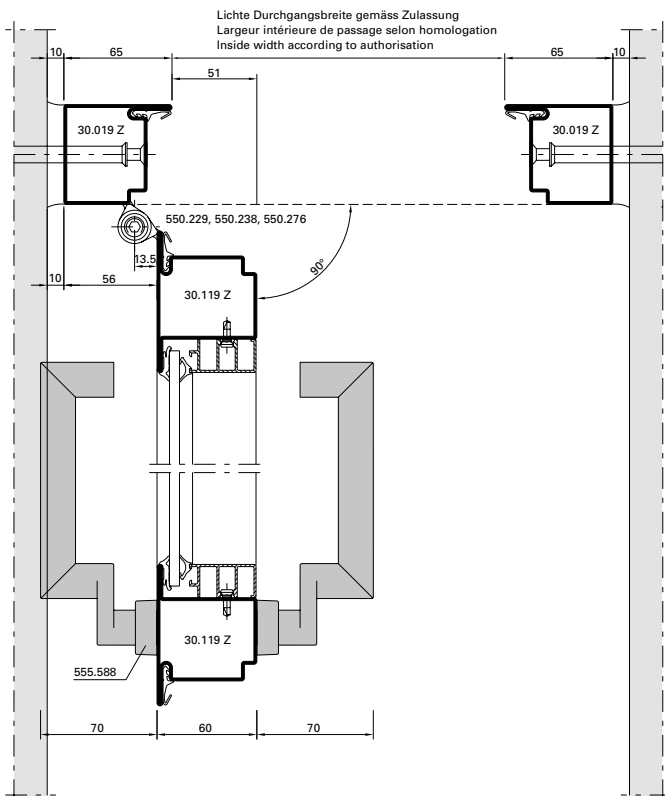

DXF **DWG** 41-0301-E-013

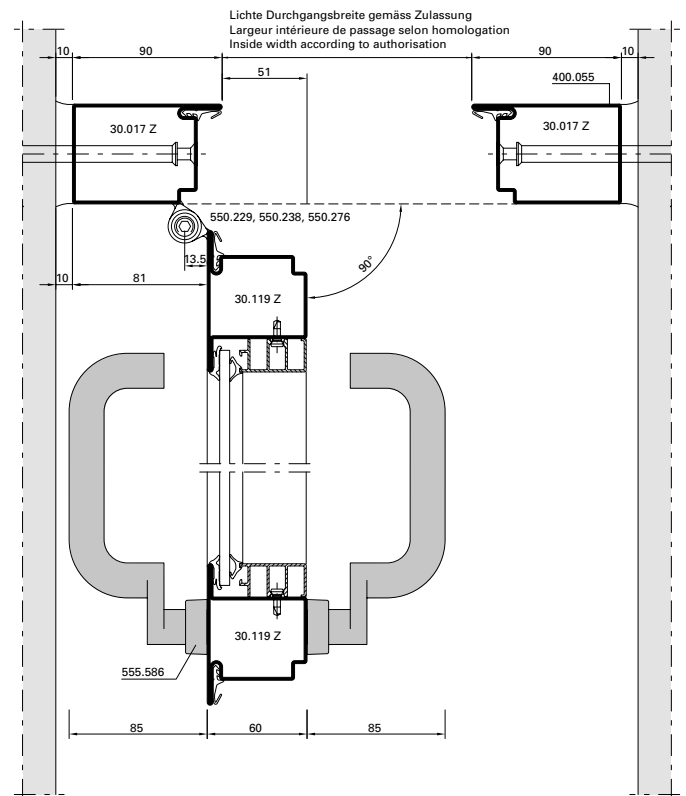

DXF **DWG** 41-0301-E-014

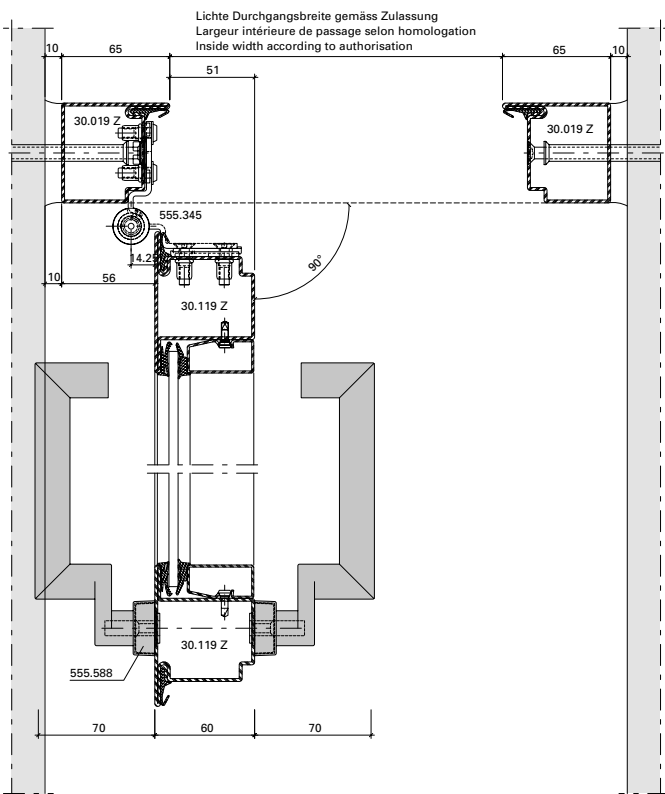

DXF **DWG** 41-0301-E-015

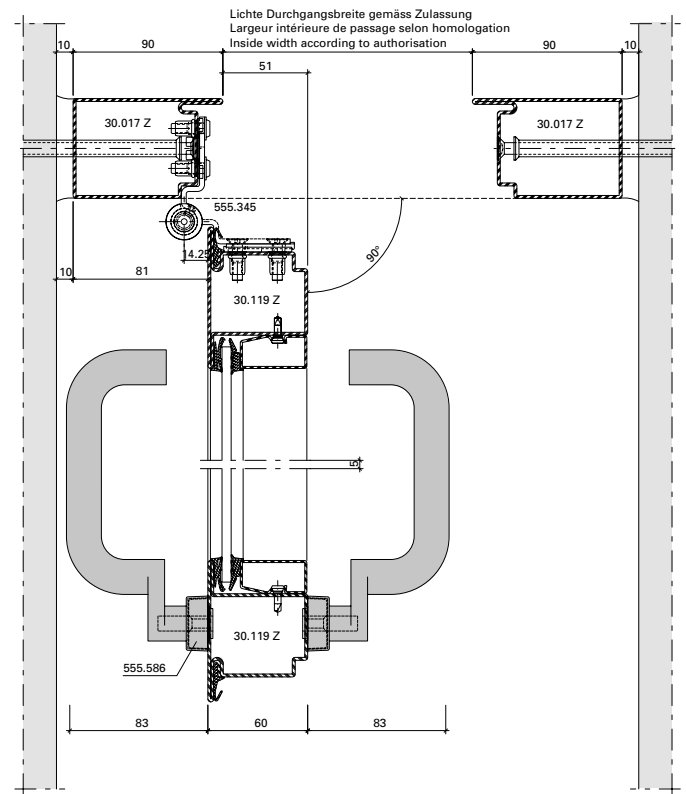

DXF **DWG** 41-0301-E-016

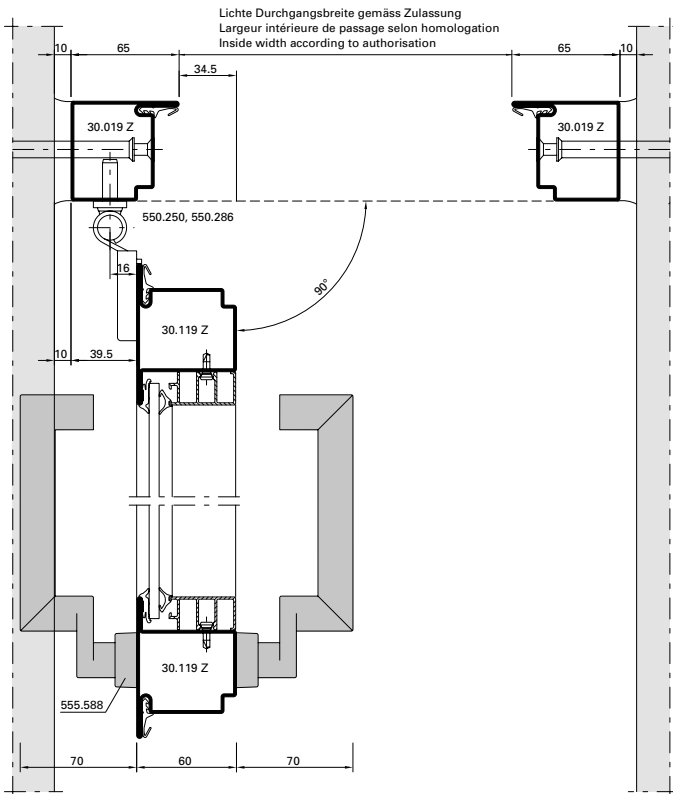

DXF **DWG** 41-0301-E-017

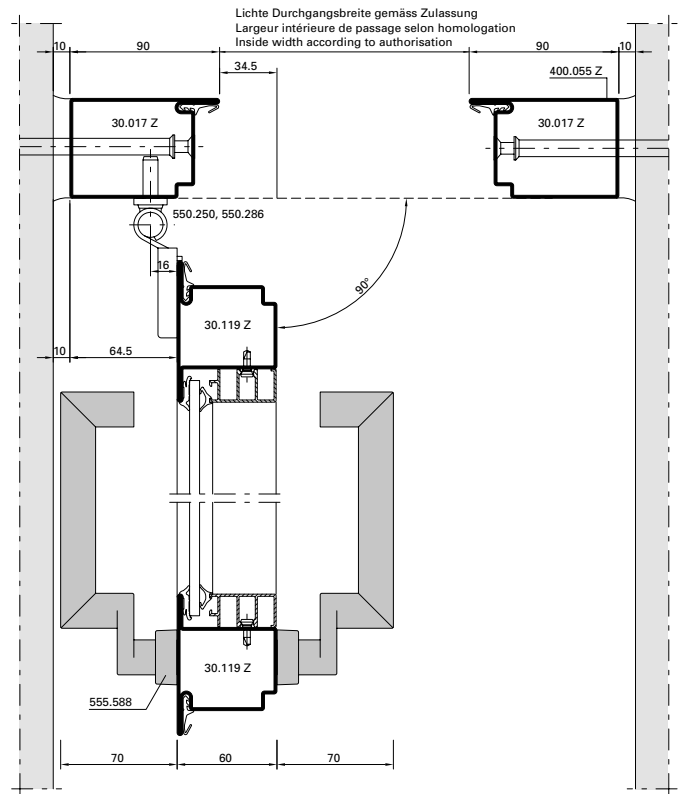

DXF **DWG** 41-0301-E-018

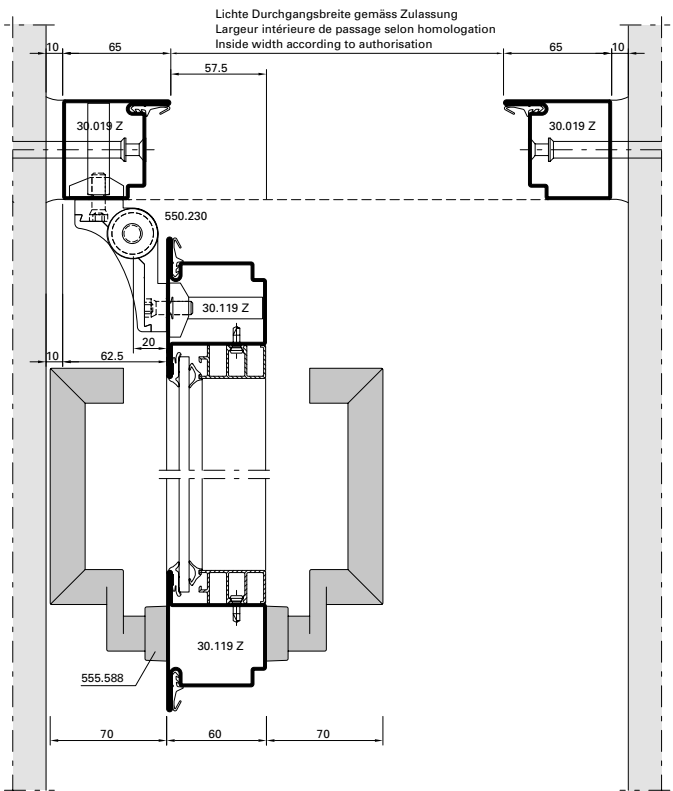

DXF **DWG** 41-0301-E-019

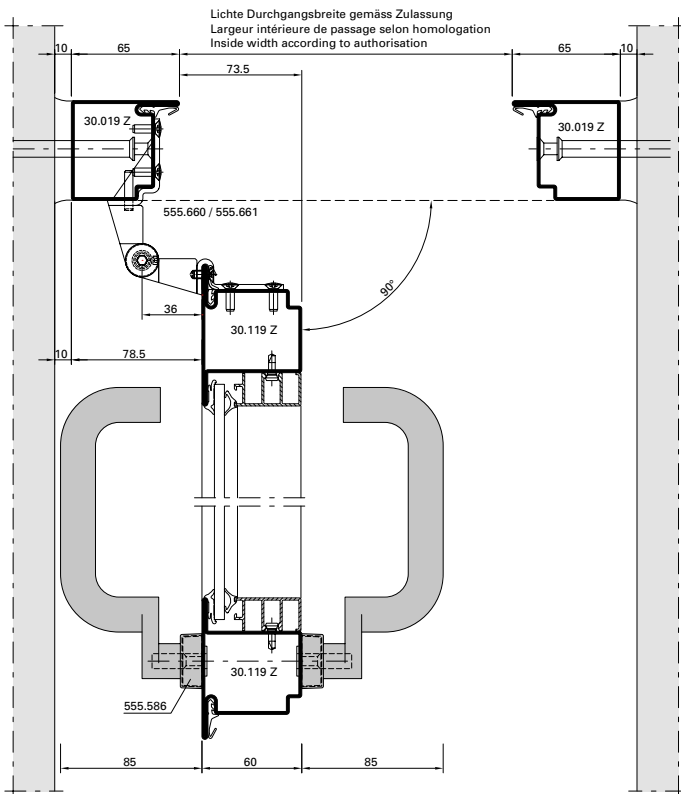

DXF **DWG** 41-0301-E-023

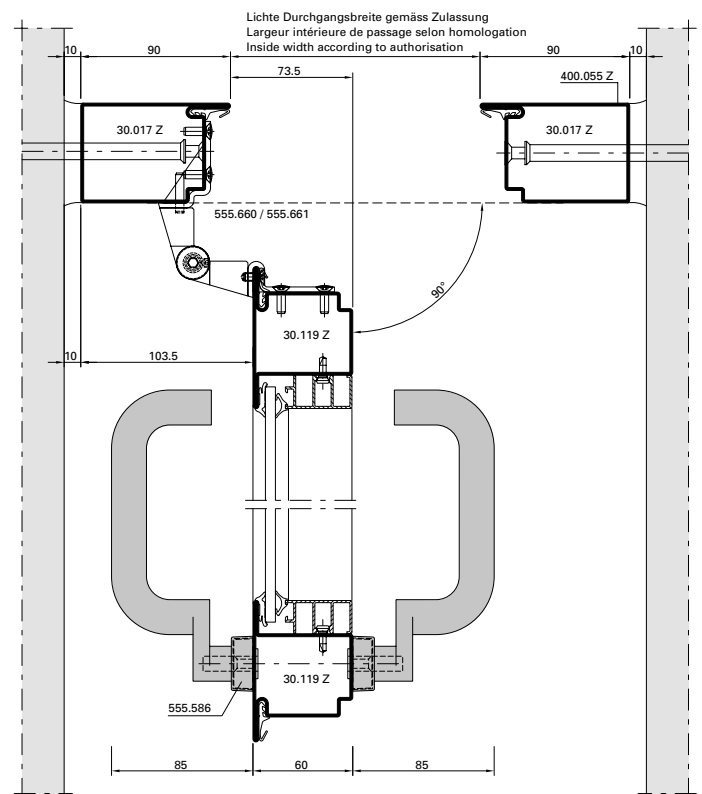

DXF **DWG** 41-0301-E-022

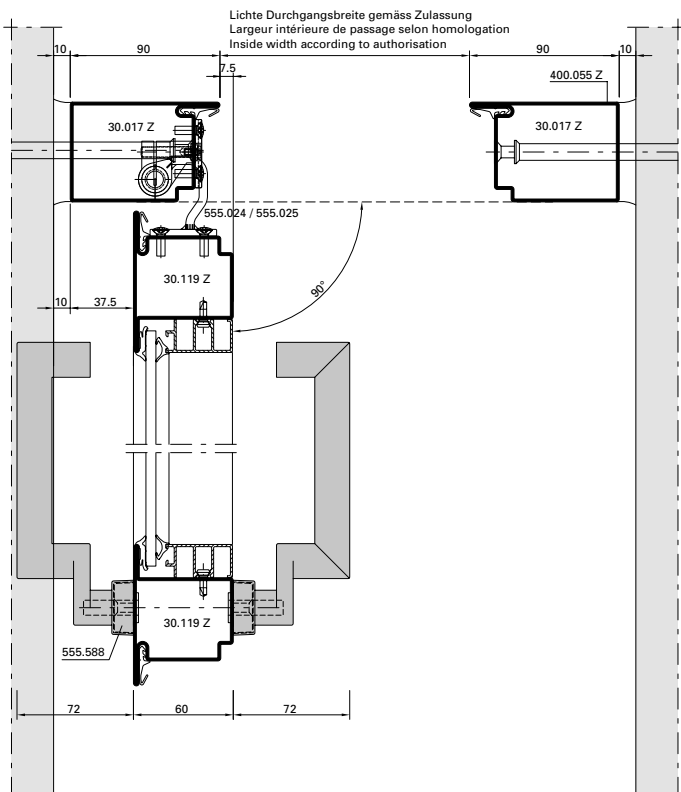

DXF **DWG** 41-0301-E-021

Anschlüsse am Bau im Massstab 1:2
Raccords au mur à l'échelle 1:2
Attachment to structure on scale 1:2

Jansen-Economy 60 RS
Jansen-Economy 60 RS
Jansen-Economy 60 RS

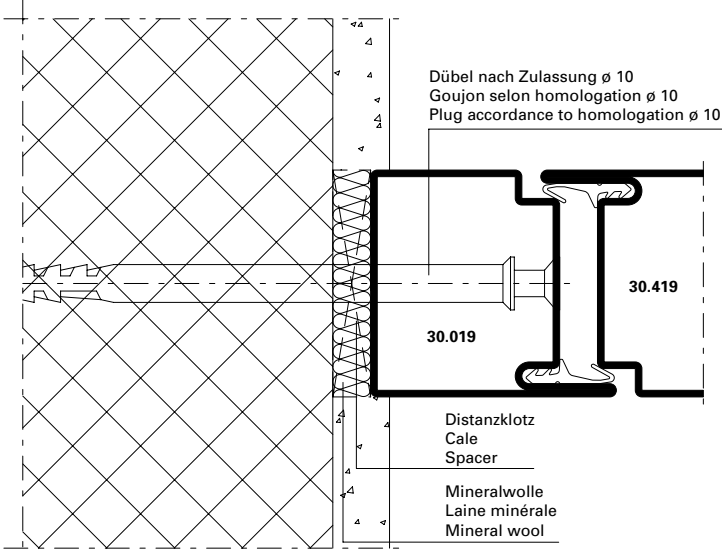

DXF DWG 41-0301-A-014

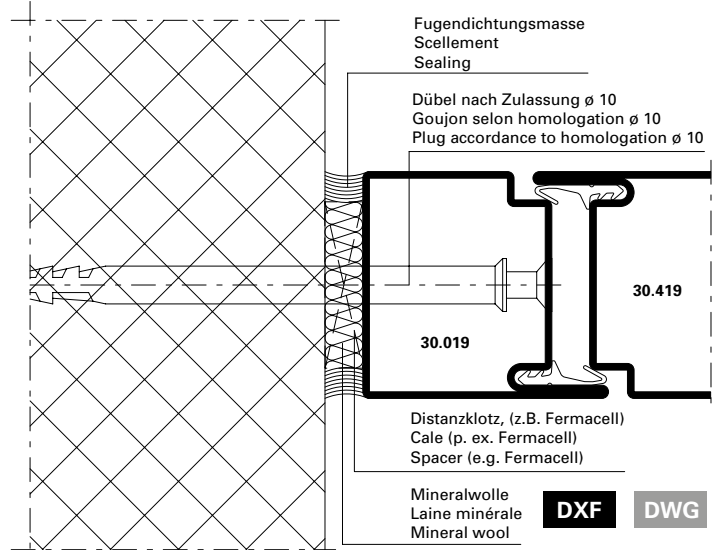

DXF DWG 41-0301-A-015

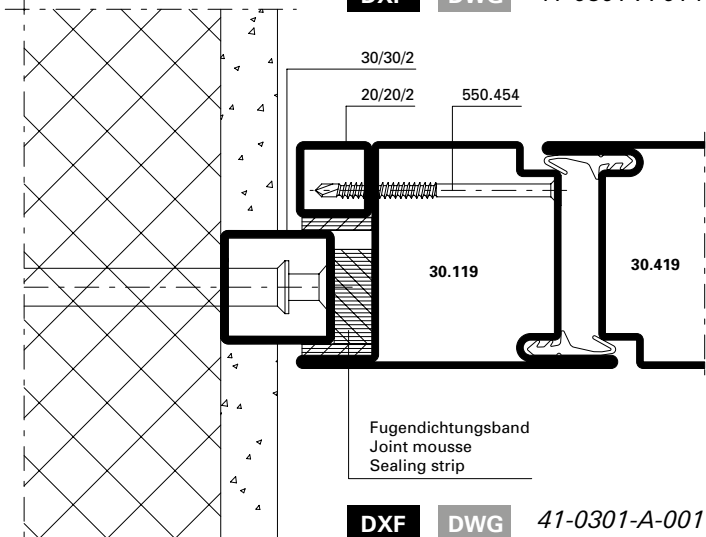

DXF DWG 41-0301-A-001

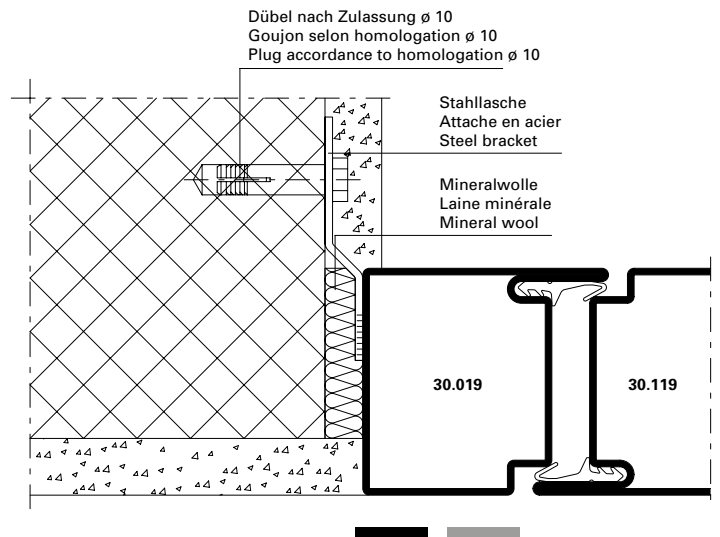

DXF DWG 41-0301-A-002

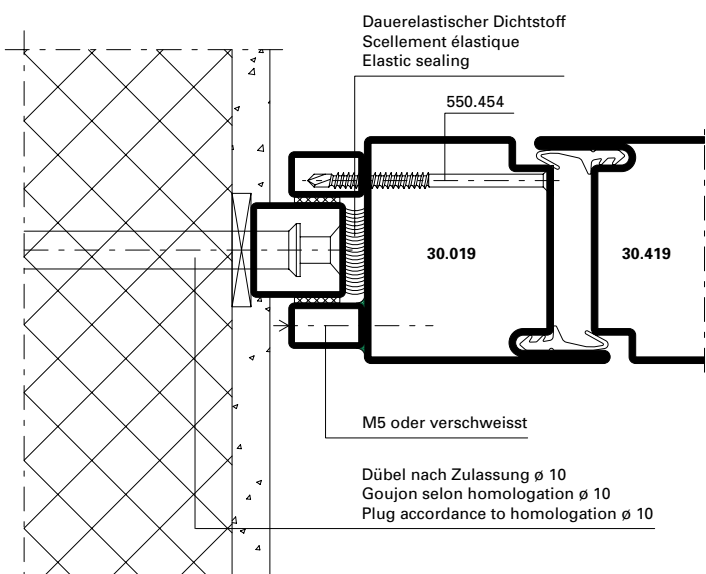

DXF DWG 41-0301-A-003

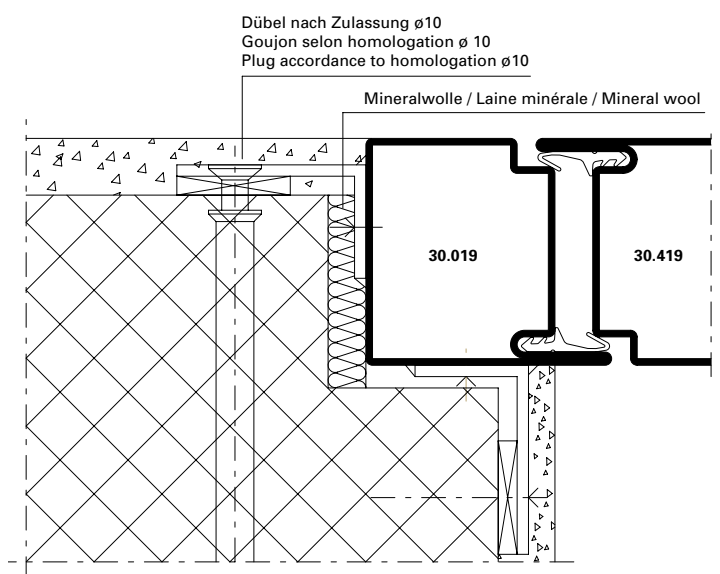

DXF DWG 41-0301-A-016

Anschlüsse am Bau im Masstab 1:2
Raccords au mur à l'échelle 1:2
Attachment to structure on scale 1:2

Jansen-Economy 60 RS
 Jansen-Economy 60 RS
 Jansen-Economy 60 RS

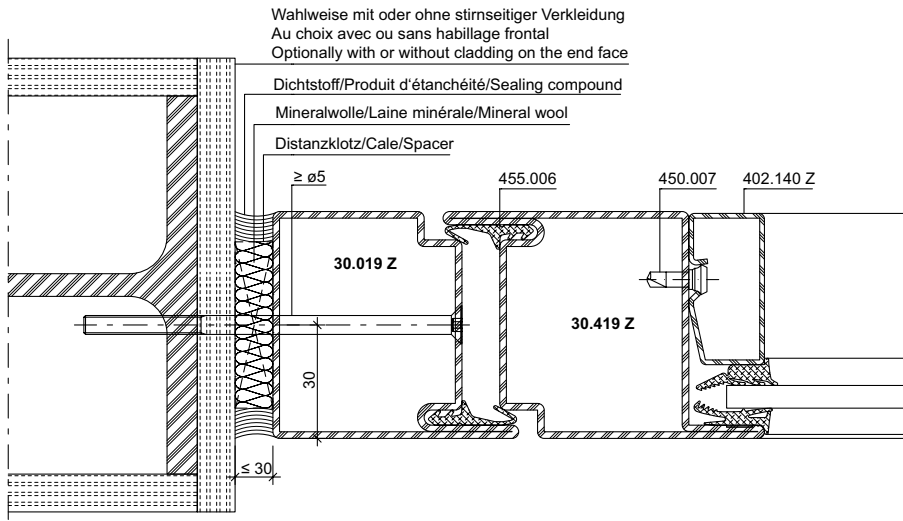

DXF

DWG

41-0301-A-004

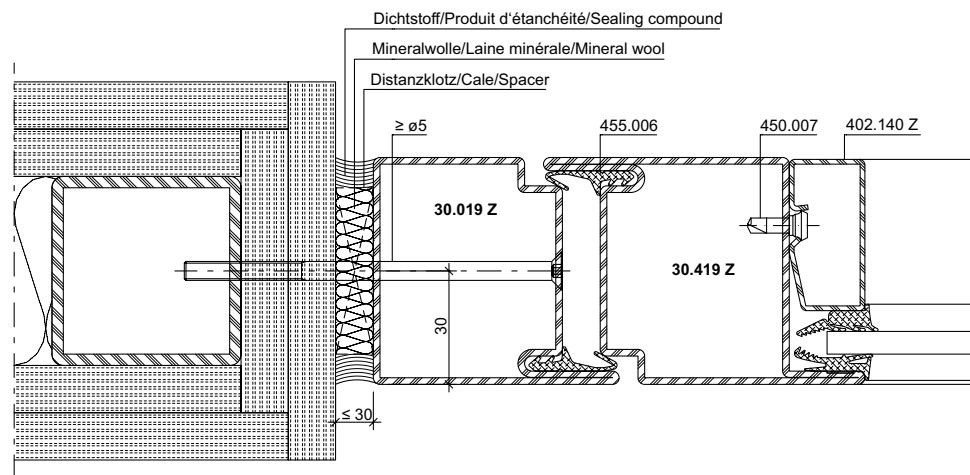

DXF

DWG

41-0301-A-006

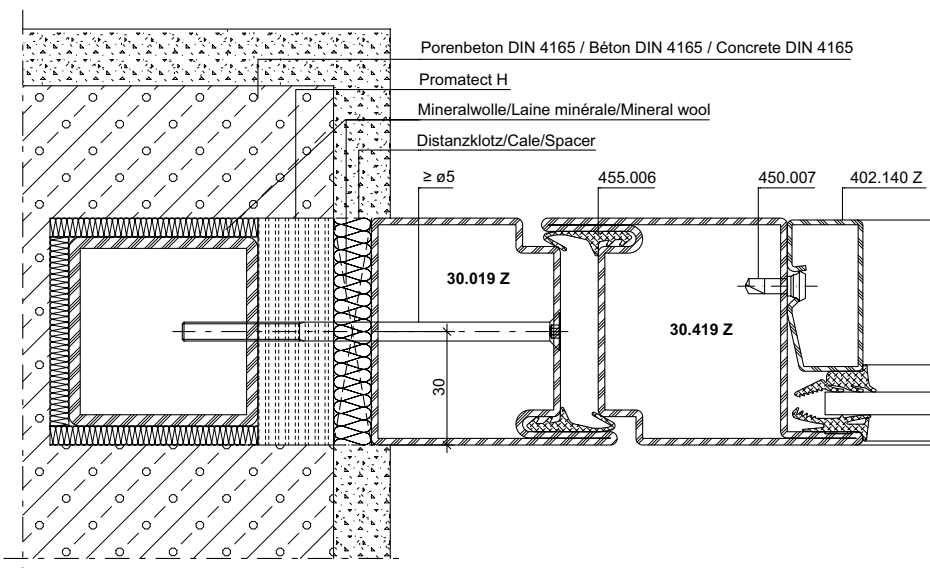

DXF

DWG

41-0301-A-008

Anschlüsse am Bau im Massstab 1:2

Raccords au mur à l'échelle 1:2

Attachment to structure on scale 1:2

Jansen-Economy 60 RS

Jansen-Economy 60 RS

Jansen-Economy 60 RS

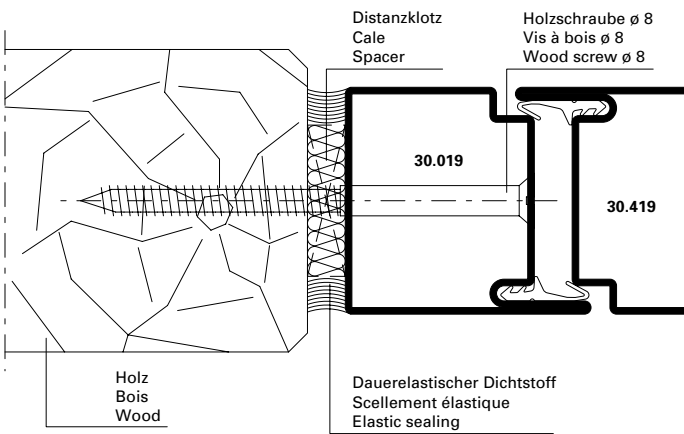

DXF **DWG** 41-0301-A-005

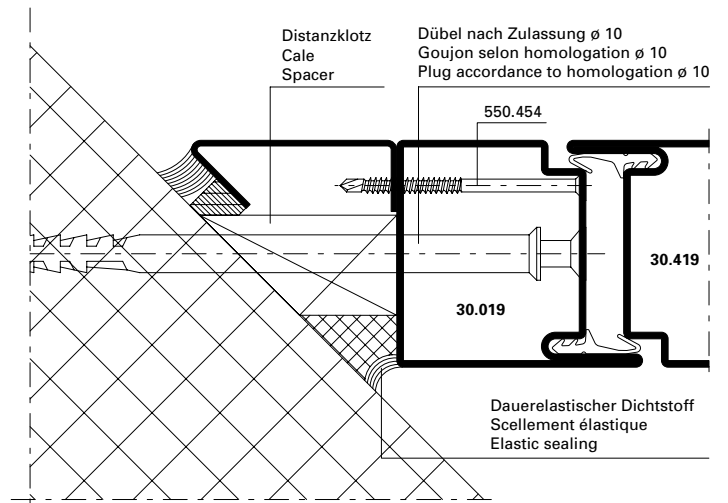

DXF **DWG** 41-0301-A-007

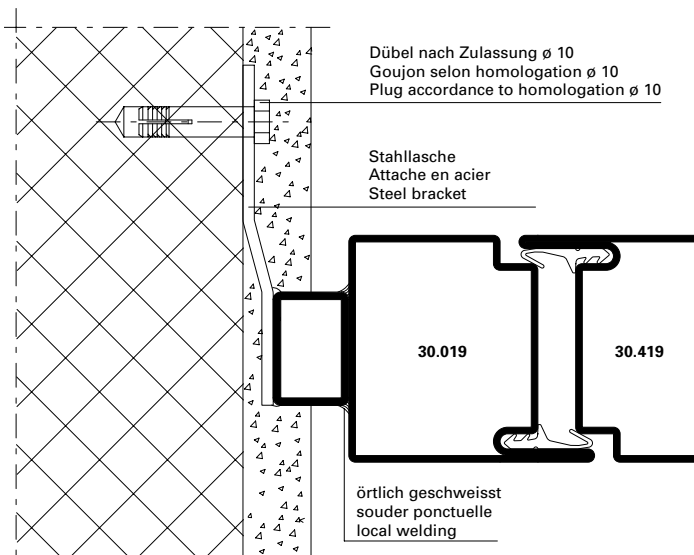

DXF **DWG** 41-0301-A-009

41-0301-A-011

DXF DWG

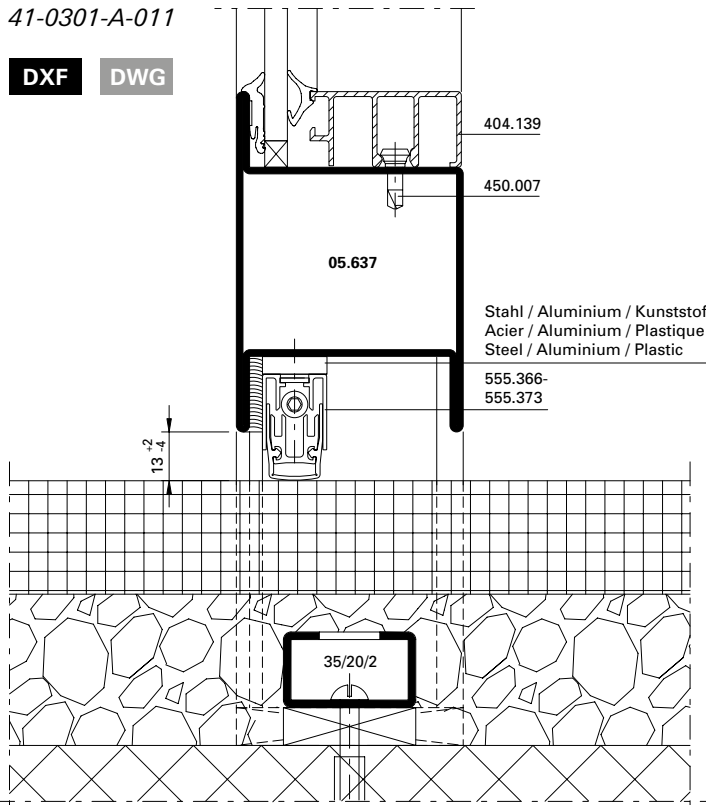

41-0301-A-013

DXF DWG

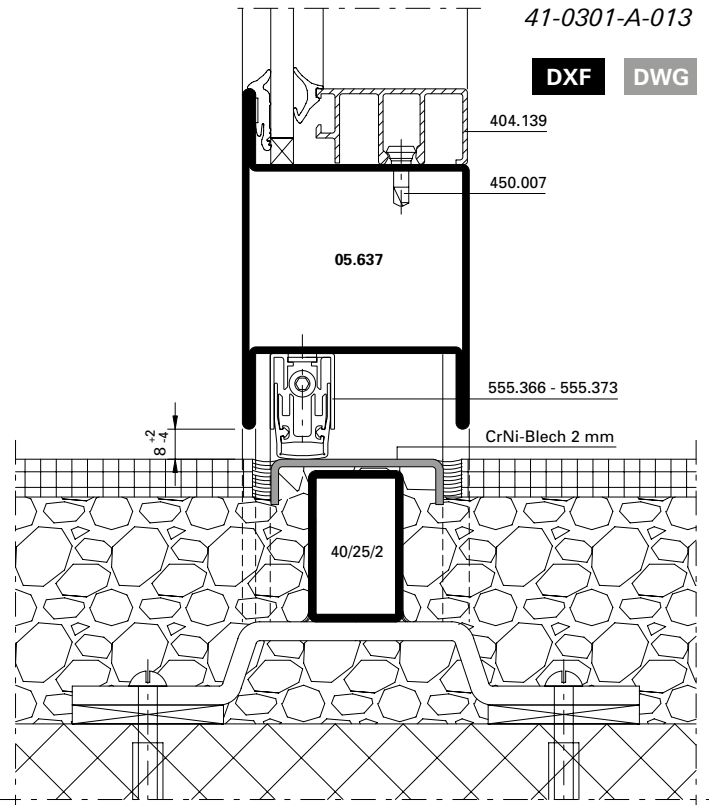

41-0301-A-010

DXF DWG

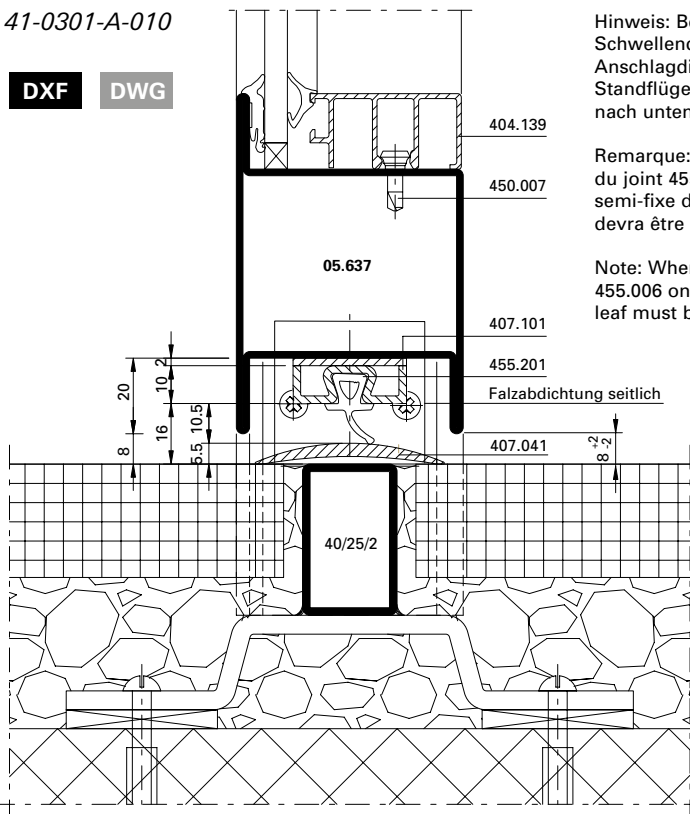

Hinweis: Bei Verwendung der Schwelldichtung 455.201 oder Anschlagdichtung 455.006 muss der Standflügel von zweiflügeligen Türen nach unten verriegelt werden.

Remarque: Dans le cas de l'utilisation du joint 455.201 ou 455.006, le vantail semi-fixe des portes à deux vantaux devra être verrouillé aussi en bas.

Note: When using gasket 455.201 or 455.006 on two leaf doors the fixed leaf must be locked towards the bottom.

41-0301-A-012

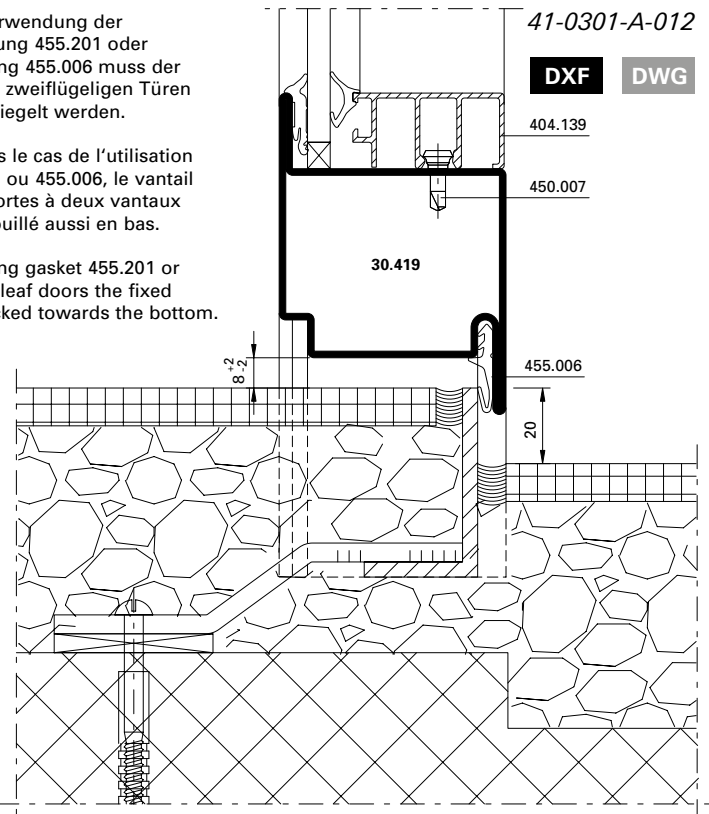

DXF DWG



Einflügelige Türen,
 auswärts öffnend,
 Flügelhöhe ≤ 2200 mm

Porte à un vantail,
 ouvrant vers l'extérieur,
 hauteur du vantail ≤ 2200 mm

Single leaf door,
 outward opening,
 leaf height ≤ 2200 mm

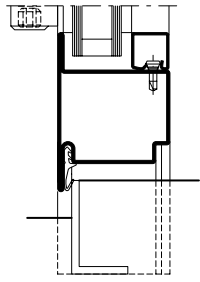
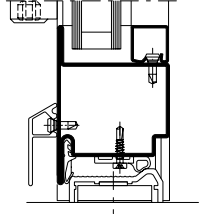
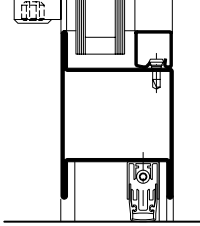
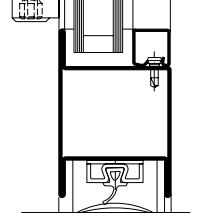
Variante	Beschlag Ferrure Fitting	 EN 12207	 EN 12208	 EN 12210	
Anschlagdichtung Joint de butée Rebate gasket		1	2	1A	C4
		2	2	2A	C4
		3	3	2A	C5
Doppel-Anschlagdichtung Joint de base double Double rebate gasket		1	4	3A	C4
		2	4	3A	C4
		3	4	5A	C5
Senkdichtung Joint seuil Drop seal		1	2	1A	C4
		2	2	2A	C4
		3	3	2A	C5
Auflaufdichtung Joint de contact Ramp seal		1	2	0	C4
		2	2	0	C4
		3	2	0	C5

1 Fallenriegel-Schloss
 Serrure à mortaiser
 Latch and bolt lock





2 Schloss mit Obenverriegelung
 Serrure avec verrouillage supérieur
 Lock with top locking point

3 Mehrfachverriegelungs-Schloss
 Serrure à verrouillage multiple
 Multipoint lock

Einflügelige Türen,
 einwärts öffnend,
 Flügelhöhe ≤ 2200 mm

Porte à un vantail,
 ouvrant vers l'intérieur,
 hauteur du vantail ≤ 2200 mm

Single leaf door,
 inward opening,
 leaf height ≤ 2200 mm

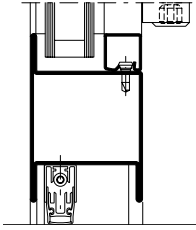
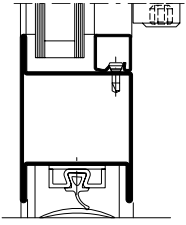
Variante		Beschlag Ferrure Fitting	 EN 12207	 EN 12208	 EN 12210
Senkdichtung Joint seuil Drop seal		❶	2	0	C4
		❷	2	0	C4
		❸	3	1A	C5
Auflaufdichtung Joint de contact Ramp seal		❶	2	0	C4
		❷	2	0	C4
		❸	2	0	C5

❶ Fallenriegel-Schloss
 Serrure à mortaiser
 Latch and bolt lock



❷ Schloss mit Obenverriegelung
 Serrure avec verrouillage supérieur
 Lock with top locking point

❸ Mehrfachverriegelungs-Schloss
 Serrure à verrouillage multiple
 Multipoint lock

Einflügelige Türen,
 auswärts öffnend,
 Flügelhöhe ≤ 3000 mm

Porte à un vantail,
 ouvrant vers l'extérieur,
 hauteur du vantail ≤ 3000 mm

Single leaf door,
 outward opening,
 leaf height ≤ 3000 mm

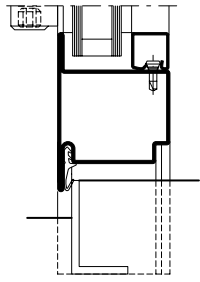
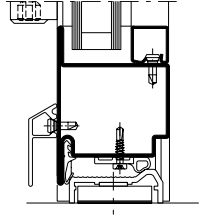
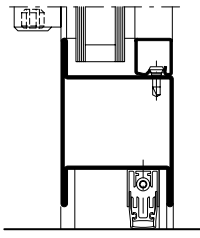
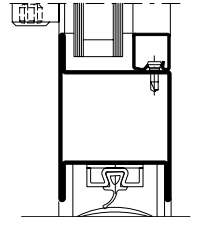
Variante	Beschlag Ferrure Fitting	 EN 12207	 EN 12208	 EN 12210
Anschlagdichtung Joint de butée Rebate gasket 	1	1	0	C1
	2	1	0	C1
	3	1	0	C2
Doppel-Anschlagdichtung Joint de base double Double rebate gasket 	1	1	1A	C1
	2	1	1A	C1
	3	2	2A	C2
Senkdichtung Joint seuil Drop seal 	1	1	0	C1
	2	1	0	C1
	3	1	0	C2
Auflaufdichtung Joint de contact Ramp seal 	1	0	0	C1
	2	0	0	C1
	3	1	0	C2

1 Fallenriegel-Schloss
 Serrure à mortaiser
 Latch and bolt lock





2 Schloss mit Obenverriegelung
 Serrure avec verrouillage supérieur
 Lock with top locking point

3 Mehrfachverriegelungs-Schloss
 Serrure à verrouillage multiple
 Multipoint lock

Einflügelige Türen,
 einwärts öffnend,
 Flügelhöhe ≤ 3000 mm

Porte à un vantail,
 ouvrant vers l'intérieur,
 hauteur du vantail ≤ 3000 mm

Single leaf door,
 inward opening,
 leaf height ≤ 3000 mm

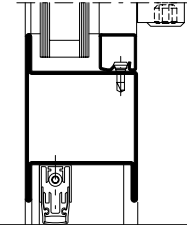
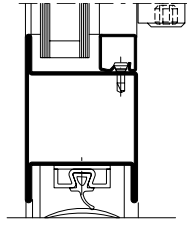
Variante		Beschlag Ferrure Fitting	 EN 12207	 EN 12208	 EN 12210
Senkdichtung Joint seuil Drop seal		❶	1	0	C1
		❷	1	0	C1
		❸	1	0	C2
Auflaufdichtung Joint de contact Ramp seal		❶	0	0	C1
		❷	0	0	C1
		❸	1	0	C2

❶ Fallenriegel-Schloss
 Serrure à mortaiser
 Latch and bolt lock



❷ Schloss mit Obenverriegelung
 Serrure avec verrouillage supérieur
 Lock with top locking point

❸ Mehrfachverriegelungs-Schloss
 Serrure à verrouillage multiple
 Multipoint lock

Zweiflügelige Türen,
 auswärts öffnend,
 Flügelhöhe ≤ 2200 mm

Porte à deux vantaux,
 ouvrant vers l'extérieur,
 hauteur du vantail ≤ 2200 mm

Double leaf door,
 outward opening,
 leaf height ≤ 2200 mm

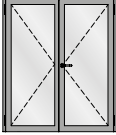
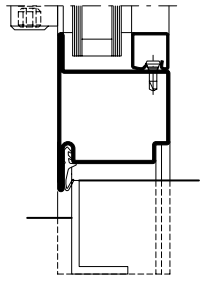
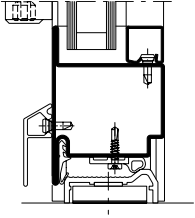
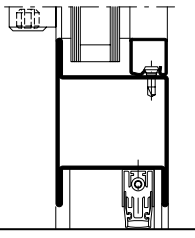
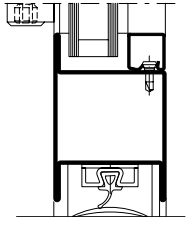
Variante	Beschlag Ferrure Fitting	 EN 12207	 EN 12208	 EN 12210	
					
Anschlagdichtung Joint de butée Rebate gasket		1	2	1A	C2
		2	2	2A	C2
		3	2	2A	C3
Doppel-Anschlagdichtung Joint de base double Double rebate gasket		1	2	2A	C2
		2	2	2A	C2
		3	3	3A	C3
Senkdichtung Joint seuil Drop seal		1	2	1A	C2
		2	2	2A	C2
		3	2	2A	C3
Auflaufdichtung Joint de contact Ramp seal		1	2	0	C2
		2	2	0	C2
		3	2	0	C3

1 Fallenriegel-Schloss
 Serrure à mortaiser
 Latch and bolt lock





2 Schloss mit Obenverriegelung
 Serrure avec verrouillage supérieur
 Lock with top locking point

3 Mehrfachverriegelungs-Schloss
 Serrure à verrouillage multiple
 Multipoint lock

Zweiflügelige Türen,
 einwärts öffnend,
 Flügelhöhe ≤ 2200 mm

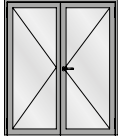
Porte à deux vantaux,
 ouvrant vers l'intérieur,
 hauteur du vantail ≤ 2200 mm

Double leaf door,
 inward opening,
 leaf height ≤ 2200 mm

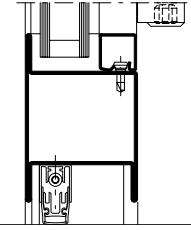
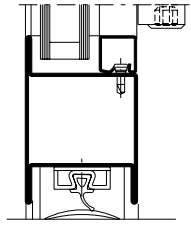
Variante		Beschlag Ferrure Fitting	 EN 12207	 EN 12208	 EN 12210
Senkdichtung Joint seuil Drop seal		❶	2	0	C2
		❷	2	0	C2
		❸	2	0	C3
Auflaufdichtung Joint de contact Ramp seal		❶	2	0	C2
		❷	2	0	C2
		❸	2	0	C3

❶ Fallenriegel-Schloss
 Serrure à mortaiser
 Latch and bolt lock



❷ Schloss mit Obenverriegelung
 Serrure avec verrouillage supérieur
 Lock with top locking point

❸ Mehrfachverriegelungs-Schloss
 Serrure à verrouillage multiple
 Multipoint lock

Zweiflügelige Türen,
 auswärts öffnend,
 Flügelhöhe ≤ 3000 mm

Porte à deux vantaux,
 ouvrant vers l'extérieur,
 hauteur du vantail ≤ 3000 mm

Double leaf door,
 outward opening,
 leaf height ≤ 3000 mm

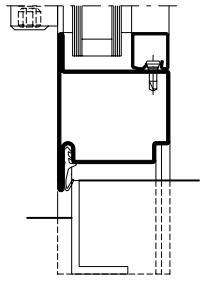
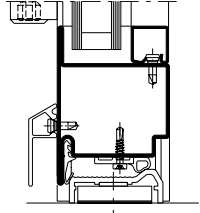
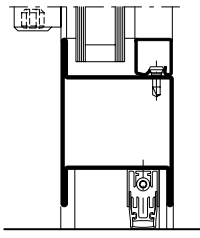
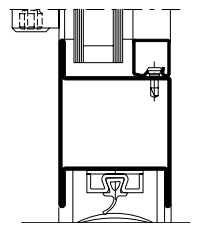
Variante	Beschlag Ferrure Fitting	 EN 12207	 EN 12208	 EN 12210
Anschlagdichtung Joint de butée Rebate gasket 	❶ ❷ ❸	0	0	C1
		0	0	C1
		1	0	C2
Doppel-Anschlagdichtung Joint de base double Double rebate gasket 	❶ ❷ ❸	1	0	C1
		1	0	C1
		2	0	C2
Senkdichtung Joint seuil Drop seal 	❶ ❷ ❸	0	0	C1
		0	0	C1
		1	0	C2
Aufaufdichtung Joint de contact Ramp seal 	❶ ❷ ❸	0	0	C1
		0	0	C1
		1	0	C2

❶ Fallenriegel-Schloss
 Serrure à mortaiser
 Latch and bolt lock





❷ Schloss mit Obenverriegelung
 Serrure avec verrouillage supérieur
 Lock with top locking point

❸ Mehrfachverriegelungs-Schloss
 Serrure à verrouillage multiple
 Multipoint lock

Zweiflügelige Türen,
 einwärts öffnend,
 Flügelhöhe ≤ 3000 mm

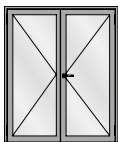
Porte à deux vantaux,
 ouvrant vers l'intérieur,
 hauteur du vantail ≤ 3000 mm

Double leaf door,
 inward opening,
 leaf height ≤ 3000 mm

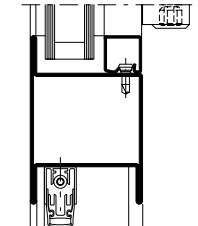
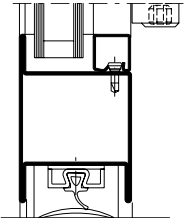
Variante		Beschlag Ferrure Fitting	 EN 12207	 EN 12208	 EN 12210
Senkdichtung Joint seuil Drop seal		1	0	0	C1
		2	0	0	C1
		3	1	0	C2
Auflaufdichtung Joint de contact Ramp seal		1	0	0	C1
		2	0	0	C1
		3	1	0	C2

U_f-Werte
(nach EN ISO 10077-2:2018-01)

Valeurs U_f
(selon EN ISO 10077-2:2018-01)

U_f values
(according to
EN ISO 10077-2:2018-01)

Auf den folgenden Seiten
finden Sie die U_f-Werte für die
verschiedenen Anwendungen von
Jansen-Economy 60 RS.

Vous trouverez les valeurs U_f
pour les différentes applications
Jansen-Economy 60 RS. dans les
pages qui suivent.

On the following pages you
will find the U_f values for the
various applications for
Jansen-Economy 60 RS.

Sie basieren auf folgenden
Grundlagen:

Elles se basent sur les principes
suivants:

They are based on the following:

Stahl

- Profile bandverzinkter Stahl,
unbeschichtet
- Stahl-Glasleisten
- Trockenverglasung
- Nassverglasung

Acier

- Profilés en bande d'acier zingué,
sans revêtement
- Parcloses en acier
- Vitrage à sec
- Vitrage à mastic

Steel

- Strip galvanised steel profiles,
uncoated
- Steel glazing beads
- Glazing with dry glazing
- Glazing with sealing

U_f-Werte
 (nach EN ISO 10077-2:2018-01)

Valeurs U_f
 (selon EN ISO 10077-2:2018-01)

U_f values
 (according to EN ISO 10077-2:2018-01)

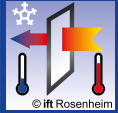
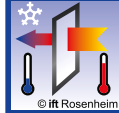
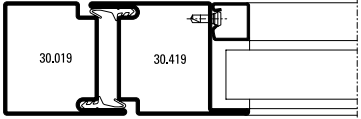
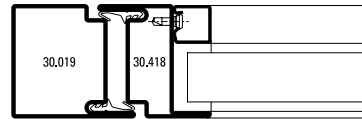
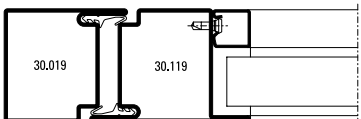
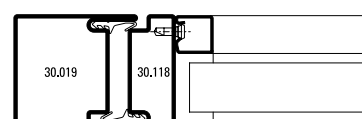
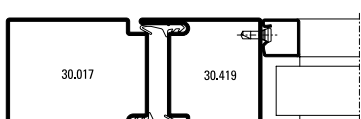
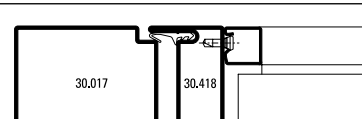
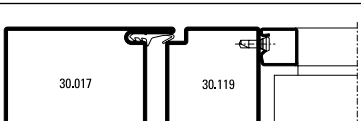
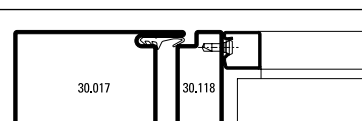
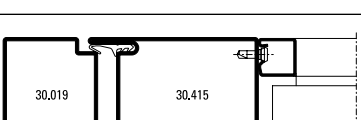
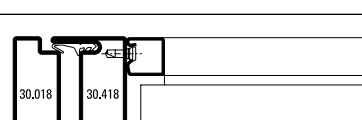
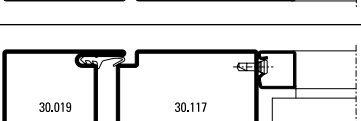
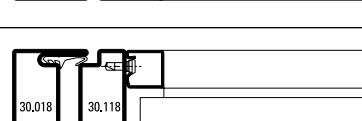
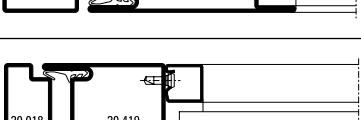
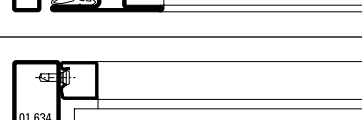
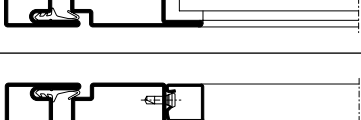
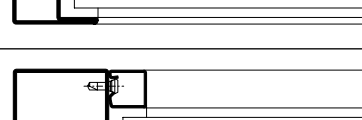
 Füllelementstärken Elements de remplissages Infill elements ≥ 24 mm		 Füllelementstärken Elements de remplissages Infill elements ≥ 24 mm	
	5,5 W/m ² K		5,7 W/m ² K
	5,6 W/m ² K		5,8 W/m ² K
	5,3 W/m ² K		5,5 W/m ² K
	5,3 W/m ² K		5,5 W/m ² K
	5,3 W/m ² K		6,0 W/m ² K
	5,3 W/m ² K		6,1 W/m ² K
	5,6 W/m ² K		6,9 W/m ² K
	5,7 W/m ² K		6,1 W/m ² K

U_f-Werte
 (nach EN ISO 10077-2:2018-01)

Valeurs U_f
 (selon EN ISO 10077-2:2018-01)

U_f values
 (according to EN ISO 10077-2:2018-01)

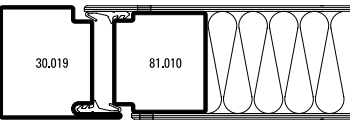
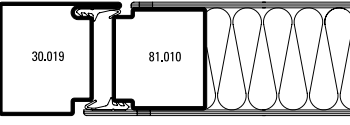
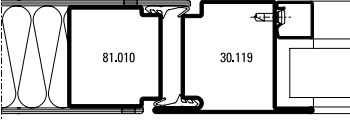
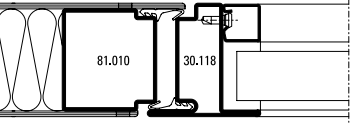
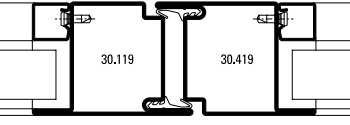
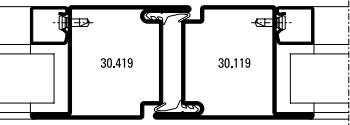
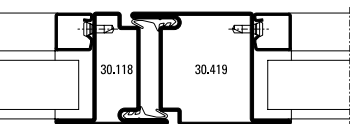
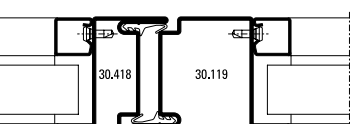

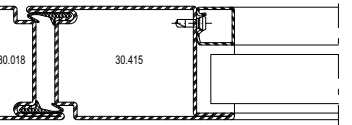
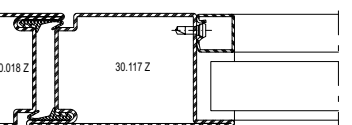
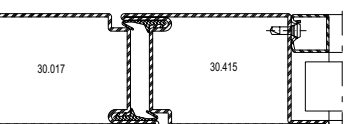
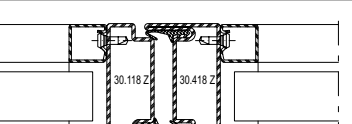
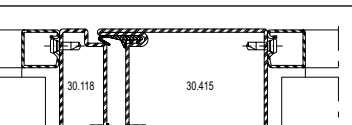
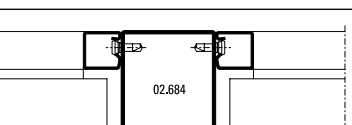
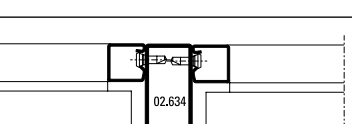
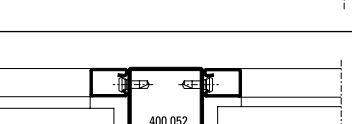
 Füllelementstärken Elements de remplissages Infill elements ≥ 24 mm	
	5,3 W/m²K
	5,3 W/m²K
	5,7 W/m²K
	6,0 W/m²K
	5,8 W/m²K
	5,8 W/m²K
	6,1 W/m²K
	6,1 W/m²K

 Füllelementstärken Elements de remplissages Infill elements ≥ 24 mm	
	5,3 W/m²K
	5,4 W/m²K
	5,1 W/m²K
	6,5 W/m²K
	5,7 W/m²K
	6,3 W/m²K
	7,2 W/m²K
	6,4 W/m²K

U_f-Werte
 (nach EN ISO 10077-2:2018-01)

Valeurs U_f
 (selon EN ISO 10077-2:2018-01)

U_f values
 (according to EN ISO 10077-2:2018-01)

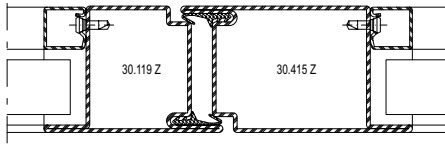
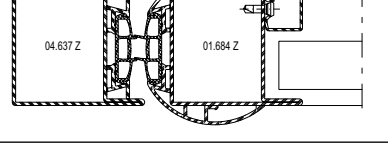
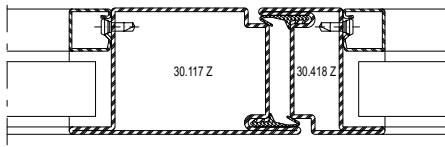
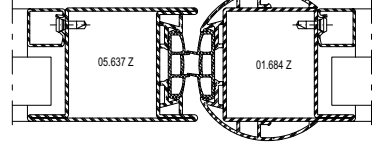
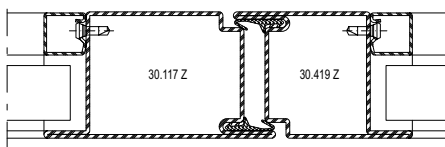
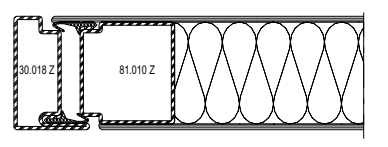
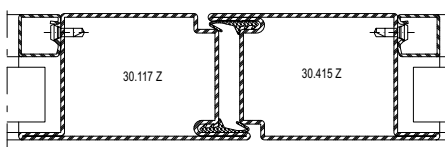
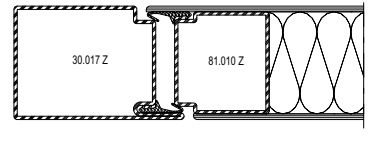
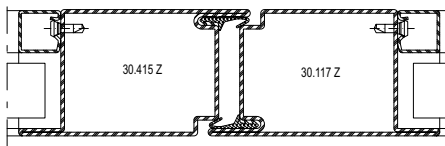
	Füllelementstärken Elements de remplissages Infill elements ≥ 24 mm		Füllelementstärken Elements de remplissages Infill elements ≥ 24 mm
	5,5 W/m²K		5,8 W/m²K
	5,7 W/m²K		6,0 W/m²K
	5,5 W/m²K		5,4 W/m²K
	5,3 W/m²K		5,1 W/m²K
	5,3 W/m²K		

U_f-Werte
 (nach EN ISO 10077-2:2018-01)

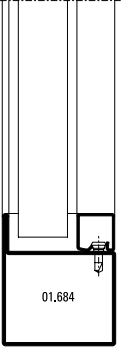
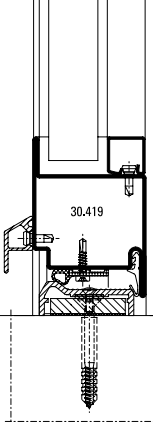
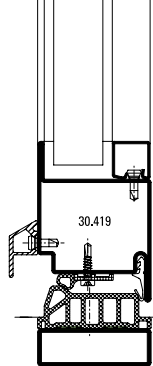
 <p>Füllelementstärken Elements de remplissages Infill elements</p> <p>≥ 24 mm</p>	
 <p>01.684</p>	<p>6,1 W/m²K</p>
 <p>30.419</p>	<p>6,3 W/m²K</p>
 <p>30.419</p>	<p>5,6 W/m²K</p>

Valeurs U_f
 (selon EN ISO 10077-2:2018-01)

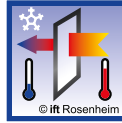
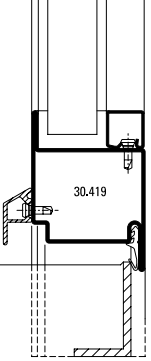
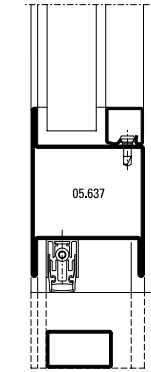
 <p>Füllelementstärken Elements de remplissages Infill elements</p> <p>≥ 24 mm</p>	
 <p>30.419</p>	<p>6,3 W/m²K</p>
 <p>05.637</p>	<p>5,6 W/m²K</p>

U_f values
 (according to EN ISO 10077-2:2018-01)

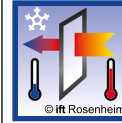
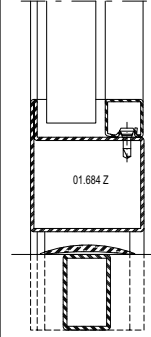
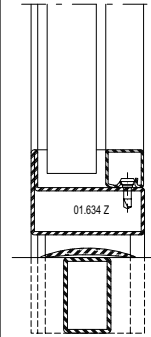
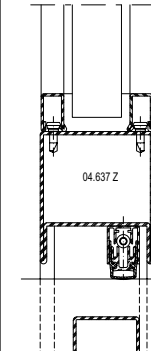
 <p>Füllelementstärken Elements de remplissages Infill elements</p> <p>≥ 24 mm</p>	
 <p>01.684 Z</p>	<p>6,1 W/m²K</p>
 <p>01.634 Z</p>	<p>6,8 W/m²K</p>
 <p>04.637 Z</p>	<p>5,5 W/m²K</p>

U_f-Werte
 (nach EN ISO 10077-2:2018-01)

Valeurs U_f
 (selon EN ISO 10077-2:2018-01)

U_f values
 (according to EN ISO 10077-2:2018-01)

	Füllelementstärken Elements de remplissages Infill elements ≥ 24 mm
	5,6 W/m²K

	Füllelementstärken Elements de remplissages Infill elements ≥ 24 mm
	5,6 W/m²K

	Füllelementstärken Elements de remplissages Infill elements ≥ 24 mm
	5,7 W/m²K
	5,7 W/m²K

	4,4 W/m²K
--	------------------

	5,2 W/m²K
--	------------------



Schallschutz

Ausführungsvarianten

Die nachfolgende Typenübersicht ergibt einen Überblick über die beurteilten Varianten.

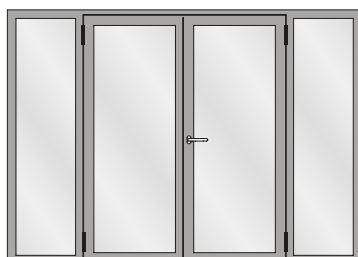
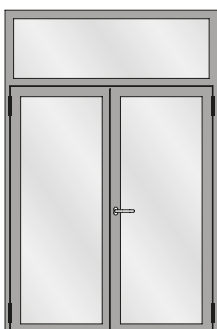
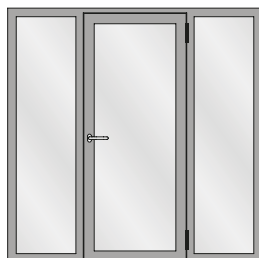
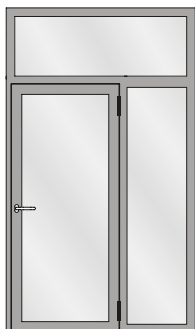
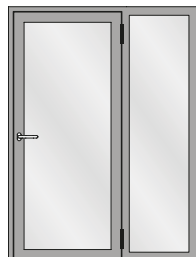
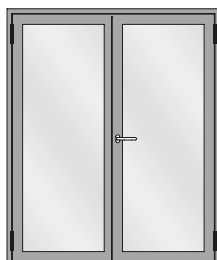
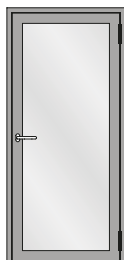

Isolation phonique

Modèles

L'aperçu des types suivant fournit une vue d'ensemble des variantes examinées.

Sound insulation

Design range

The following overview of types provides an overview of the evaluated designs.

Schallschutz

Isolation phonique

Sound insulation

Tabelle A1

Korrekturtabelle für Jansen-Economy-Türen mit Glasfüllungen

Tableau A1

Tableau de correction pour les portes Jansen-Economy avec vitrage

Table A1

Correction table for Jansen-Economy doors with glass

	1	2	3	4	5	6	7	8	9	10	11
	Türe mit zwei absenkba- ren Bodendichtungen Porte avec deux joint seuil automatique Door with two threshold gaskets that can be lowered	Glas Verre Glass	Korrekturen Corrections Corrections								
	$R_{w(C, Ctr)}$ dB	$R_{w, P, Glas}$ dB	K_S dB	K_{FV} dB	K_{Nass} dB	K_{1aB} dB	$K_{W/S}$ dB	$K_{G 0,4}$ dB	$K_{G 1,8}$ dB	$K_{G 2,6}$ dB	$K_{G 3,2}$ dB
1	32 (-1; -5)	31	0	-1	0	0	0	0	-1	-2	-3
2	33 (-1; -5)	32	0	-1	0	0	0	0	-1	-2	-3
3	35 (-1; -5)	34	0	-1	0	0	0	0	-1	-2	-3
4	36 (-2; -5)	35	0	-1	-1	0	0	0	-1	-2	-3
5	37 (-2; -5)	37	0	0	-1	0	-1	0	-1	-2	-3
6	38 (-2; -5)	39	0	0	-1	-1	-1	0	-1	-2	-3
7	39 (-2; -5)	40	0	0	-1	-1	-1	0	-1	-2	-3
8	40 (-2; -5)	41	0	0	-1	-1	-2	-1	-1	-2	-3
9	41 (-2; -5)	42	0	0	-1	-1	-2	-2	-1	-2	-3
10	42 (-2; -5)	43	-1	0	-1	-1	-2	-2	-1	-2	-3
11	42 (-2; -5)	44	-1	0	-1	-1	-2	-2	-1	-2	-3
12	43 (-2; -5)	45	-1	+1	-1	-1	-3	-3	-1	-2	-3
13	44 (-2; -5)	49	-1	+1	-1	-2	-3	-3	-1	-2	-3

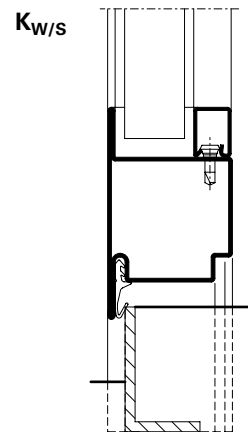
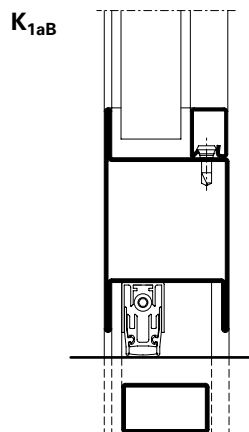
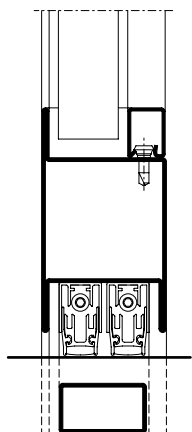

Schallschutz

Der aus der Tabelle A1 abzulesende Wert für die Schalldämmung $R_{w, Tür}$ beträgt:

Isolation phonique

La valeur à relever sur le tableau A1 concernant l'isolement contre les sons aériens $R_{w, Porte}$ est la suivante:

Sound insulation

The value taken from table A1 for the sound insulation $R_{w, Door}$ is:

$$R_{w, Tür} = R_w + K_S + K_{FV} + K_{Nass} + K_{1aB} + K_{W/S} + K_{Band} + K_{G 0,4} + K_{G 1,8} + K_{G 2,6} + K_{G 3,2} \text{ dB}$$

- R_w** bewertetes Schalldämm-Mass der Türe in Abhängigkeit von der Schalldämmung $R_{w,P, Glas}$
- $R_{w,P, Glas}$** bewertetes Schalldämm-Mass der Verglasung (Prüfwert nach ISO 140-3, mit Prüfnachweis einer PÜZ-Stelle). Alternativ können Tabellenwerte nach DIN EN 12758, Abschnitt 6 verwendet werden
- K_S** Korrekturwert für zweiflügelige Türen
- K_{FV}** Korrekturwert für Festverglasungen mit erhöhtem Scheibenanteil
- K_{Nass}** Korrekturwert für Nassverglasung
- K_{1aB}** Korrekturwert für Türen mit einer absenkbaren Bodendichtung
- K_{Band}** Korrekturwert bei Verwendung von Anschlagbändern, die eine Dichtungsebene unterbrechen ($K_{Band} = - 0,5 \text{ dB pro Band}$)
- $K_{W/S}$** Korrekturwert für Türen mit einer Anschlagsschwelle
- $K_{G 0,4}$** Korrekturwert für Einzelscheiben mit einer Glasfläche $\leq 0,4 \text{ m}^2$. Die Korrektur gilt auch für Konstruktionen mit glasteilenden Sprossen.
- $K_{G 1,8}$** Korrekturwert für Einzelscheiben mit einer Glasfläche $\geq 1,8 \text{ m}^2$
- $K_{G 2,6}$** Korrekturwert für Einzelscheiben mit einer Glasfläche $\geq 2,6 \text{ m}^2$
- $K_{G 3,2}$** Korrekturwert für Einzelscheiben mit einer Glasfläche $\geq 3,2 \text{ m}^2$

- R_w** Mesure d'isolement contre les sons aériens des portes évaluée suivant l'isolement phonique $R_{w,P, Glas}$
- $R_{w,P, Glas}$** Cote d'isolement acoustique du vitrage évalué (valeur contrôlée selon ISO 140-3 avec certificat d'un bureau de contrôle, de surveillance ou de certification). Il est également possible d'utiliser les valeurs selon le tableau DIN EN 12758, section 6
- K_S** Valeur de correction pour portes à deux vantaux
- K_{FV}** Valeur de correction pour vitrages fixes à fort pourcentage de vitre
- K_{Nass}** Valeur de correction pour vitrage avec mastic
- K_{1aB}** Valeur de correction pour portes avec un joint seuil automatique
- K_{Band}** Valeur corrective en cas d'utilisation de paumelles qui interrompent un plan d'étanchéité ($K_{Band} = - 0,5 \text{ dB par paumelle}$)
- $K_{W/S}$** Valeur de correction pour portes avec un seuil de butée
- $K_{G 0,4}$** Valeur de correction pour vitres individuelles avec une surface vitrée $\leq 0,4 \text{ m}^2$. La correction s'applique aussi aux constructions à meneaux séparant les vitres.
- $K_{G 1,8}$** Valeur de correction pour vitres individuelles avec surface vitrée $\geq 1,8 \text{ m}^2$
- $K_{G 2,6}$** Valeur de correction pour vitres individuelles avec surface vitrée $\geq 2,6 \text{ m}^2$
- $K_{G 3,2}$** Valeur de correction pour vitres individuelles avec surface vitrée $\geq 3,2 \text{ m}^2$

- R_w** Airborne sound reduction index of doors depending on the sound insulation $R_{w,P, Glas}$
- $R_{w,P, Glas}$** Airborne sound reduction index (test value in accordance with ISO 140-3, with a test certificate from a recognised testing, inspection or certification body). Alternatively, the tabulated values in DIN EN 12758, Section 6 may be used
- K_S** Correction value for double-leaf doors
- K_{FV}** Correction value for fixed glazing with increased proportion of pane
- K_{Nass}** Correction value for glazing with sealing
- K_{1aB}** Correction value for doors with a threshold gasket that can be lowered
- K_{Band}** Correction value when using hinges that interrupt a sealing plane ($K_{Band} = - 0.5 \text{ dB per hinge}$)
- $K_{W/S}$** Correction value for doors with a rebate threshold
- $K_{G 0,4}$** Correction value for single panes with a glass area $\leq 0,4 \text{ m}^2$. The correction also applies to buildings with glazing bars
- $K_{G 1,8}$** Correction value for single panes with a glass area $\geq 1,8 \text{ m}^2$
- $K_{G 2,6}$** Correction value for single panes with a glass area $\geq 2,6 \text{ m}^2$
- $K_{G 3,2}$** Correction value for single panes with a glass area $\geq 3,2 \text{ m}^2$

METALFORM

Jansen AG

Steel Systems
Industriestrasse 34
9463 Oberriet
Schweiz
jansen.com

JANSEN
METALFORM

Jansen-Economy 60 RS (Smoke)

Rauchschutztüren nach EN 1634-3 und EN 16034 aus Stahl

Jansen-Economy 60 RS (Smoke)

Portes coupe-fumée selon EN 1634-3 et EN 16034 en acier

Jansen-Economy 60 RS (Smoke)

Smoke control doors according to EN 1634-3 and EN 16034 in steel

Grafische Planungsdaten wie z.B. Anwendungsbeispiele, Konstruktionsdetails, Anschlüsse am Bau, die in unseren physischen oder elektronischen Dokumentationsunterlagen enthalten sind, sind schematische Darstellungen. Gleiches gilt für digitale Medien wie CAD Dateien oder BIM Modelle.

Sie sollen den ausführenden Metallbauer und/oder Fachplaner bei der Planung und Ausführung eines Projektes unterstützen. Sie sind im konkreten Anwendungsfall durch den ausführenden Metallbauer und/oder Fachplaner auf die Verwendbarkeit im konkreten betroffenen Projekt hinsichtlich rechtlichen/regulatorischen aber auch technischen objektspezifischen Anforderungen zu überprüfen und ggfs. eigenverantwortlich anzupassen.

Bei der Überprüfung, der spezifischen Planung und der Umsetzung sind die objektspezifischen Rahmenbedingungen (Material der Bausubstanz, Dimension des Einbauelements, Farbe, Exposition, Lasteinwirkung, etc.) sowie der geltende Stand der Technik einschliesslich aller anwendbaren Normen und technischen Richtlinien eigenverantwortlich zu beachten.

Falls das vorliegende Dokument Differenzen zur aktuellen deutschen Version (Artikel Nr. K1214227) aufweist, gilt in jedem Fall der deutsche Originaltext in der jeweils geltenden Fassung im Jansen Docu Center.

Alle Ausführungen dieser Dokumentation haben wir sorgfältig und nach bestem Wissen zusammengestellt. Wir können aber keine Verantwortung für die Benutzung der vermittelten Vorschläge und Daten übernehmen. Wir behalten uns technische Änderungen ohne Vorankündigung vor.

Les données de planification graphiques, comme les exemples d'application, détails de construction et raccordements au bâtiment, fournies dans notre documentation physique et numérique sont des représentations schématiques. Il en va de même pour les médias numériques comme les fichiers CAD ou modèles BIM.

Leur but est de faciliter la planification et réalisation d'un projet par les constructeurs métalliques et/ou concepteurs. Concrètement, elles doivent être vérifiées par le constructeur métallique et/ou le concepteur et, le cas échéant, modifiées de son propre chef pour s'assurer qu'elles concordent avec le projet concerné et qu'elles répondent aux exigences techniques spécifiques ainsi qu'aux dispositions légales et réglementaires.

Lors de la vérification, de la planification spécifique et de la mise en œuvre, il y a lieu de tenir compte des conditions spécifiques à l'objet (matériaux du bâtiment, dimension de l'élément d'insert, couleur, exposition, effet de charge, etc.) ainsi que de l'état actuel de la technique, y compris toutes les normes et directives techniques applicables.

En cas de divergence entre le présent document et la version allemande (no d'article K1214227), c'est dans tous les cas le texte original allemand qui prévaut dans sa version actuelle disponible dans le Jansen Docu Center.

Nous avons apporté le plus grand soin à l'élaboration de cette documentation. Cependant, nous déclinons toute responsabilité pour l'utilisation faite de nos propositions et de nos données.

Nous nous réservons le droit de procéder à des modifications techniques sans préavis.

Graphical planning data such as application examples, construction details, connections on site that are contained in our physical or electronic documentation components are schematic representations. The same applies to digital media such as CAD files or BIM models.

They are intended to support the metal worker and/or design engineer in planning and executing projects. In the specific case of application they are to be checked by the metal worker and/or design engineer in terms of their usability in the specific project concerned with regard to legal/regulatory and technical property-specific requirements and adjusted if necessary at the latter's own responsibility.

The property-specific underlying conditions (construction material, dimensions of installation element, colour, exposure, load effect etc.) and current state of the art including all applicable norms and technical guidelines are to be taken into consideration at the metal worker and/or design engineer's own responsibility during the review, specific planning and implementation.

If there are any differences between this document and the current German version (item number K1214227), the latest version of the original German text in the Jansen Docu Center shall prevail.

All the information contained in this documentation is given to the best of our knowledge and ability. However, we decline all responsibility for the use made of these suggestions and data.

We reserve the right to effect technical modifications without prior warning.

Inhaltsverzeichnis		Jansen-Economy 60 RS	
Sommaire		Jansen-Economy 60 RS	
Content		Jansen-Economy 60 RS	

Systemübersicht	Sommaire du système	Summary of system	2
Merkmale	Caractéristiques	Characteristics	
Zulassungen	Homologations	Authorisations	
Systemausführungen	Exécutions de système	System versions	
Typenübersicht	Sommaire des types	Summary of types	

Profilsortiment	Assortiment de profilé	Range of profiles	12
------------------------	-------------------------------	--------------------------	-----------

Beispiele	Exemples	Examples	16
Schnittpunkte	Coupes de détails	Section details	
Konstruktionsdetails	Détails de construction	Construction details	
Anschlüsse am Bau	Raccords au mur	Attachment to structure	

Leistungseigenschaften	Caractéristiques de performance	Performance characteristics	28
-------------------------------	--	------------------------------------	-----------







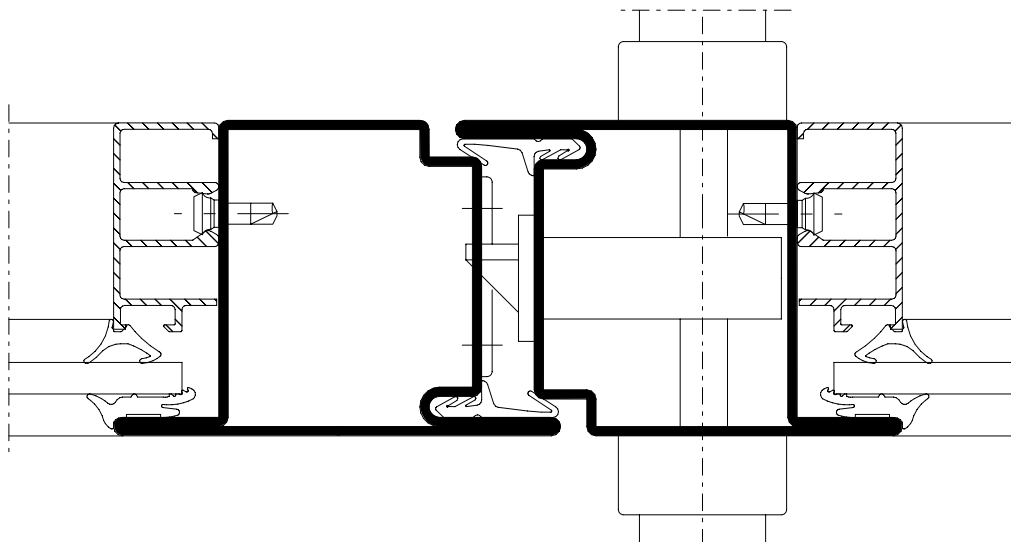

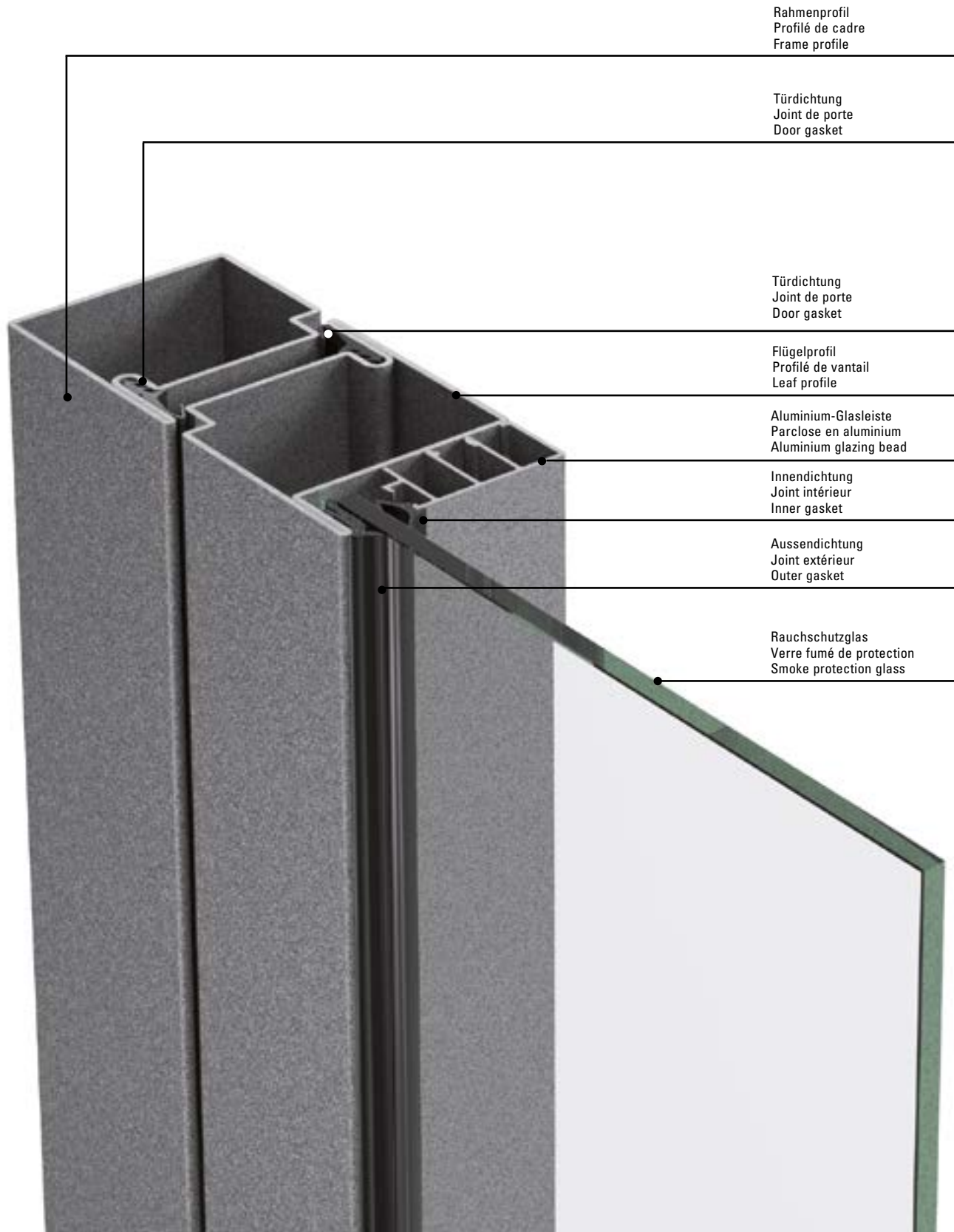

Merkmale
Caractéristiques
Characteristics





Jansen-Economy 60 RS
Jansen-Economy 60 RS
Jansen-Economy 60 RS

- Stahlssystem für Türen und Festverglasungen
 - Bautiefe 60 mm, innen und aussen flächenbündig
 - Schmale Ansichtsbreiten: Rahmen und Flügel ab 105 mm Stulppartie 150 mm
 - Ein- und zweiflüglige Türen, nach innen und aussen öffnend, mit oder ohne Seitenteile und Oberlichter sowie Trennwände
 - Türflügel bis 1750 x 3750 mm (BxH), landesspezifische Zulassung beachten
 - Füllelementstärke von 5 bis 26 mm, Glaseinbau mittels Trocken- oder Nassverglasung
 - Stahlprofile blank oder bandverzinkt
 - Grosses Sortiment an systemgeprüften Türbeschlägen
 - Barrierefreie Schwellenausbildungen
 - Geeignet für Pulver- und Nasslackbeschichtungen
 - Rauchschutztüre gemäss EN 1634-3 und EN 16034, Systemprüfungen nach Produktnorm EN 14351-1
 - Erscheinungsbild deckungsgleich mit anderen Jansen Brandschutzsystemen Jansen-Economy 50, Janisol 2 und Janisol C4
- Système en acier pour portes et vitrages fixes
 - Profondeur de montage 60 mm, montage à fleur à l'intérieur et à l'extérieur
 - Fines largeurs de face: Cadre et vantaux à partir de 105 mm Partie tête 150 mm
 - Portes à un et deux vantaux, ouverture vers l'intérieur et vers l'extérieur, combinables avec parties latérales, impostes et vitrage fixe
 - Vantaux de porte jusqu'à 1750 x 3750 mm (LaxH), il convient de respecter les prescriptions et règlements des divers pays concernés
 - Élément de remplissage de 5 à 26 mm d'épaisseur, Montage du vitrage à sec ou à silicone
 - Profilés en acier brut ou galvanisé en continu
 - Grand assortiment de ferrures de porte homologuées
 - Formes de seuil sans barrière
 - Convient aux revêtements par poudre ou peinture liquide
 - Porte coupe-fumée selon EN 1634-3 et EN 16034, contrôles des systèmes selon la norme produit EN 14351-1
 - Apparence égale comme les autres systèmes coupe-feu de Jansen (Jansen-Economy 50, Janisol 2 et Janisol C4)
- Steel system for doors and fixed glazing
 - 60 mm basic depth, flush-fitted on the inside and outside
 - Narrow face widths: Frame and leaf from 105 mm Meeting stile assembly 150 mm
 - Single and double-leaf doors, inward and outward-opening, can be combined with side-lights, toplight or fixed glazing
 - Door leaf up to 1750 x 3750 mm (WxH), the regulations and bye-laws in force in the particular country must be respected
 - Infill unit thickness of 5 to 26 mm, Glazing installed by means of dry or wet glazing
 - Raw finish or strip galvanised steel profiles
 - Large range of system-tested door fittings
 - Easy-access thresholds
 - Suitable for powder and wet paint coating
 - Smoke-proof door according to EN 1634-3 and EN 16034, system tests in accordance with EN 14351-1
 - Same appearance as the other Jansen fire-resistant systems Jansen-Economy 50, Janisol 2 and Janisol C4





Norm	Eigenschaft Caractéristique Characteristic	Klassifizierung/Wert Classification / Valeur Classification / Value										
		npd	1 (400)	2 (800)	3 (1200)	4 (1600)	5 (2000)	Exxx (>2000)				
 EN 12210	Widerstandsfähigkeit bei Windlast Résistance à la pression du vent Resistance to wind load	npd	1 (400)	2 (800)	3 (1200)	4 (1600)	5 (2000)	Exxx (>2000)				
 EN 12208	Schlagregendichtheit Etanchéité à la pluie battante Watertightness	npd	1A (0)	2A (50)	3A (100)	4A (150)	5A (200)	6A (250)	7A (300)	8A (450)	9A (600)	Exxx (>750)
 EN ISO 10140	Schalldämmung R_w (C, C_{tr}) (dB) Isolation phonique R_w (C, C_{tr}) (dB) Sound insulation R_w (C, C_{tr}) (dB)	npd	bis R_w 44 dB (-2; -5) jusqu'à R_w 44 dB (-2; -5) up to R_w 44 dB (-2; -5)									
 EN ISO 10077-2	Wärmedurchgangskoeffizient U_f (W/(m ² ·K)) Transmission thermique U_f (W/(m ² ·K)) Thermal production U_f (W/(m ² ·K))	npd	ab 5.65 W/m ² K à partir de 5.65 W/m ² K from 5.65 W/m ² K									
 EN 12207	Luftdurchlässigkeit Perméabilité à l'air Air permeability	npd	1 (150)		2 (300)		3 (600)		4 (600)			
 EN 1192	Klassifizierung der Festigkeitsanforderungen Classification des exigences de résistance méc. Classification of strength requirements	npd	1		2		3		4			
 EN 1627	Einbruchhemmung Anti-effraction Burglar resistance	npd	1		2		3		4		5	6
 EN 1522	Durchschusshemmung Résistance aux balles Bullet proofing	npd	FB1	FB2	FB3	FB4	FB5	FB6	FB7	FSG		
 EN 1191 EN 1603	Dauerfunktionsprüfung Durabilité mécanique Mechanical durability		D 1 5'000	2 10'000	3 20'000	4 50'000	5 100'000	6 200'000	7 500'000	8 1'000'000		
 EN 179 EN 1125	Fähigkeit zur Freigabe Capacité au déclenchement Ability to release		Anforderung erfüllt Exigence remplie Requirement fulfilled									

Norm	Eigenschaft Caractéristique Characteristic	Klassifizierung/Wert Classification / Valeur Classification / Value			
 EN 12217	Bedienkräfte Forces de manœuvre Operating forces	npd	0	1	2
 EN 1634-3	Rauchschutz Etanchéité à la fumée Smoke control		S_a / S_{200}		
 EN 16034 EN 13501-2	Selbstschliessung Fermeture automatique Self-closing		C		
 EN 16034	Dauerhaftigkeit der Selbstschliessung gegenüber Alterung (Korrosion) Endurance de la fermeture automatique contre le vieillissement (corrosion) Durability of self-closing against ageing (corrosion)		erzielt atteinte achieved		



Fluchttürsysteme

- Fluchttürsysteme geeignet für Notausgänge und Paniktüren
- Fluchttürnorm EN 179 für Notausgangsverschlüsse erfüllt
- Fluchttürnorm EN 1125 für Panikverschlüsse erfüllt

Systèmes de porte de secours

- Systèmes de porte de secours pour issues de secours et portes panique
- Norme relative aux portes de secours EN 179, remplie pour les fermetures d'issue de secours
- Norme relative aux portes de secours EN 1125, remplie pour les fermetures panique

Emergency exit systems

- Emergency exit systems suitable for emergency exits and panic doors
- Emergency exit standard EN 179 for emergency exit devices fulfilled
- Emergency exit standard EN 1125 for panic exit devices fulfilled



Einbruchhemmende Jansen-Economy 60 RS Türen

- Türgrößen bis 1475 x 3000 mm
- Ein- und zweiflüglige Türen, nach innen und aussen öffnend
- Normal- und Panikfunktion bis RC3
- Geprüft nach EN 1627

Portes anti-effraction Jansen-Economy 60 RS

- Dimensions de porte jusqu'à 1475 x 3000 mm
- Portes à un/deux vantaux ouvrant vers l'intérieur et l'extérieur
- Fonction normale et fonction panique jusqu'à RC3
- Contrôlé selon la norme EN 1627

Burglar-resistant Jansen Economy 60 RS doors

- Door sizes up to 1475 x 3000 mm
- Single and double-leaf doors, inward and outward-opening
- Standard and panic function up to RC3
- Tested in accordance with EN 1627



Verblechte Jansen-Economy 60 RS Türen

- Für ein- und zweiflügelige Brandschutztüren mit oder ohne Seitenteile resp. Oberlichter
- Flächenbündig verblechte Türen
- Bleche können an den Rahmen geschweisst oder geklebt werden
- Mit oder ohne Glasausschnitte möglich

Portes tôlées Jansen-Economy 60 RS

- Pour des portes coupe-feu à un/deux vantaux avec ou sans pièces latérales ou impostes
- Portes tôlées à fleur
- Les tôles peuvent être soudées ou collées sur le cadre
- Possibles avec ou sans panneaux de verre

Jansen Economy 60 RS sheet metal doors

- For single and double-leaf fire doors with or without sidelights or toplights
- Flush-fitted sheet metal doors
- Sheet metal can be welded or bonded to the frame
- Possible with or without glass vision panels

Jansen Docu Center

Die Plattform zum effizienten Arbeiten mit Jansen Dokumentationen. Im Jansen Docu Center stehen alle Produktinformationen jederzeit digital in der aktuellsten Version zur Verfügung: von Architekten-Informationen über Bestell- und Fertigungskatalogen bis hin zu Anleitungen und Prospekten sowie Videos.

Die Inhalte können einfach und schnell aufgerufen werden. Ein für den Anwender komfortables papierloses Arbeiten, das zahlreiche Vorteile bietet.

Download CAD Daten

DXF

DWG

Sie können die Zeichnungen in den Formaten DXF und/oder DWG herunterladen. Klicken Sie auf das entsprechende Icon und der Download erfolgt.

Die Hinweise «Artikelbibliothek/Türbeschläge/Fensterbeschläge» bedeuten, dass Sie mit einem Klick die gesamte Artikelbibliothek des entsprechenden Systems herunterladen (Profile, Beschläge, Glasleisten, Zubehör etc.).

Info und Beratung

Gerne beraten wir Sie persönlich und stehen Ihnen bei Fragen zur Verfügung. Bitte schreiben Sie uns Ihre Anliegen an: info@jansen.com

Jansen Docu Center

La plate-forme pour travailler efficacement avec les documentations Jansen. Le Jansen Docu Center met à votre disposition les informations sur les produits, en format numérique et dans une version actualisée: des catalogues de commande et de fabrication aux instructions et prospectus, en passant par les informations destinées aux architectes et vidéos.

Les contenus sont facilement et rapidement accessibles. Une manière de travailler confortable et offrant de nombreux avantages.

Télécharger fichiers DAO

DXF

DWG

Vous pouvez télécharger les dessins aux formats DXF et/ou DWG. Cliquez sur l'icône correspondante et le téléchargement s'effectuera.

Les indications «Bibliothèque des articles/Ferures de porte/Ferrures de fenêtres» signifie que vous téléchargez la totalité de la bibliothèque des articles du système donné (profilés, ferrures, parclofes, accessoires etc.).

Info et conseils

Nous vous conseillons volontiers individuellement et sommes à votre disposition si vous avez des questions à poser. Veuillez nous envoyer votre requête à: info@jansen.com

Jansen Docu Center

The platform for working efficiently with Jansen documentation. The latest version of all the product information is available digitally at any time in the Jansen Docu Center – from order and fabrication manuals to architect information, instructions and brochures and videos.

The content can be retrieved quickly and easily. The user can work conveniently without paper, which has numerous benefits.

Download CAD files

DXF

DWG

You can download the drawings in DXF and/or DWG format. Click on the relevant icon to begin the download.

The items «Article library/Door fittings/Window fittings» means that you download the entire article library for the corresponding system with one click (profiles, fittings, glazing beads, accessories etc.).

Information and advice

We would be delighted to provide you with advice in person and are available to answer any questions you may have. Please write to us with your queries at: info@jansen.com

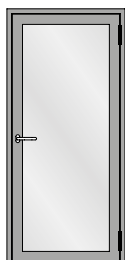

Einflügelige Türe
 Porte à un vantail
 Single leaf door

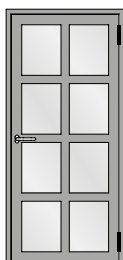

Einflügelige Türe mit Riegel
 Porte à un vantail avec traverse
 Single leaf door with transom

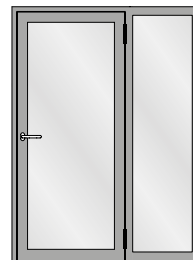

Einflügelige Türe mit festem Seitenteil
 Porte à un vantail avec partie latérale fixe
 Single leaf door with fixed side light

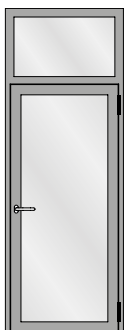

Einflügelige Türe mit festem Oberlicht
 Porte à un vantail avec imposte fixe
 Single leaf door with fixed top light

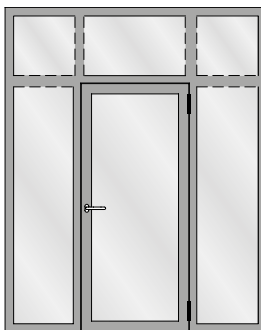

Einflügelige Türe mit zwei festen Seitenteilen
 und festem Oberlicht
 Porte à un vantail avec deux parties latérale fixe
 et imposte fixe
 Single leaf door with two fixed side light and
 fixed top light

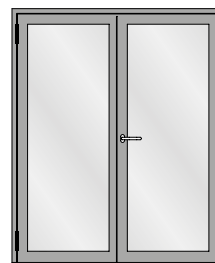

Zweiflügelige Türe
 Porte à deux vantaux
 Double leaf door



Zweiflügelige Türe mit zwei festen Seitenteilen
 Porte à deux vantaux avec deux parties
 latérales fixes
 Double leaf door with two fixed side lights

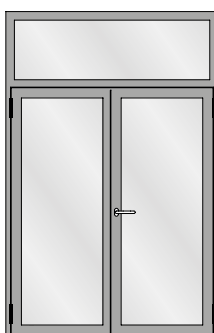

Zweiflügelige Türe mit festem Oberlicht
 Porte à deux vantaux avec imposte fixe
 Double leaf door with fixed top light

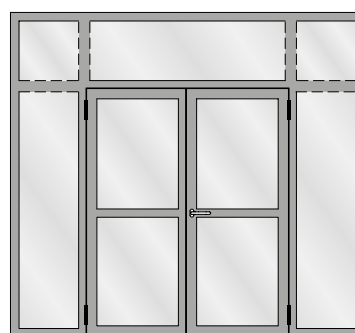

Zweiflügelige Türe mit zwei festen Seitenteilen
 und festen Oberlichtern
 Porte à deux vantaux avec deux parties latérales
 fixes et impostes fixes
 Double leaf door with two fixed side lights and
 fixed top lights

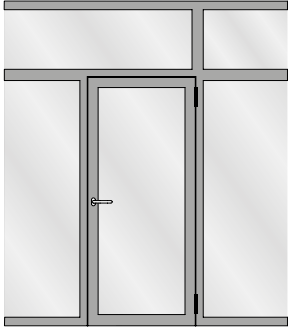

Festverglasung mit einflügeliger Türe
Vitrage fixe avec porte à un vantail
Fixed glazing with single leaf door

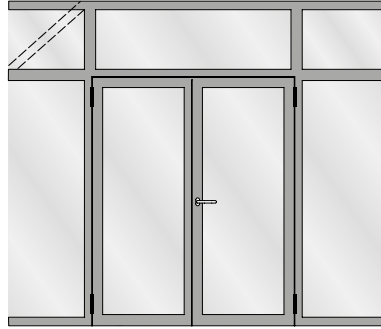

Festverglasung mit zweiflügeliger Türe
Vitrage fixe avec porte à deux vantaux
Fixed glazing with double leaf door

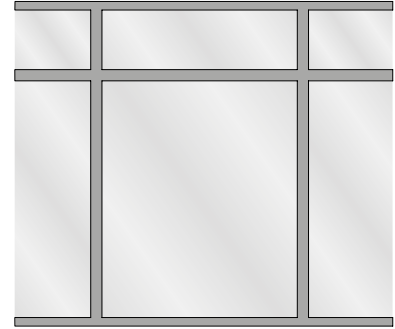

Festverglasung
Vitrage fixe
Fixed glazing

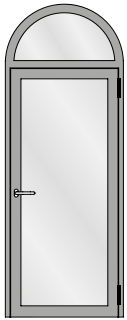

Einflügelige Türe mit Rundbogen-Oberlicht
Porte à un vantail avec imposte demi-ronde
Single leaf door with round arched top light

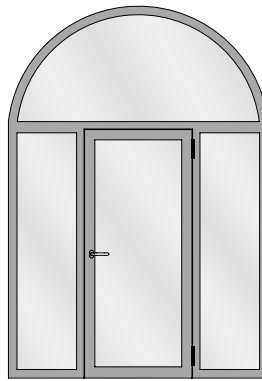

Einflügelige Türe mit zwei festen Seitenteilen
und Rundbogen-Oberlicht
Porte à un vantail avec deux parties latérales
fixes et imposte demi-ronde
Single leaf door with two fixed side lights and
round arched top light

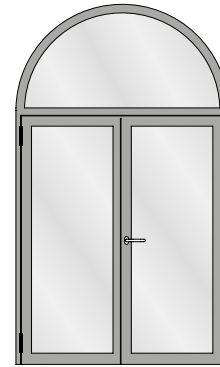

Zweiflügelige Türe mit Rundbogen-Oberlicht
Porte à deux vantaux avec imposte demi-ronde
Double leaf door with round arched top light

**Für Festverglasungen gelten
nationale Zulassungen.**

**Les homologations nationales
s'appliquent aux vitrages fixes.**

**National approvals apply to fixed
glazing.**

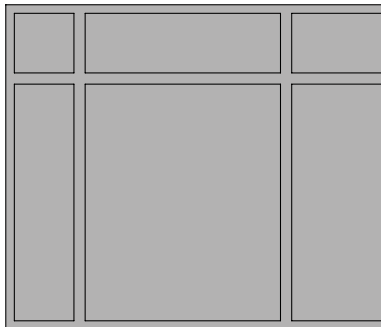
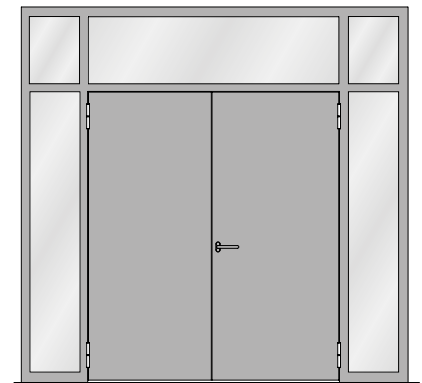
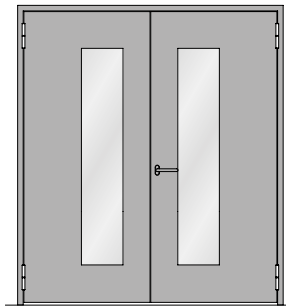
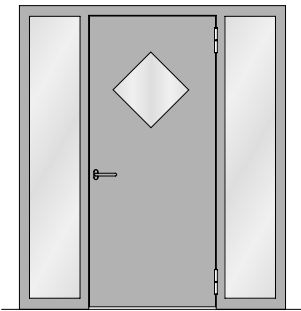
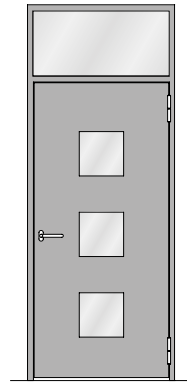
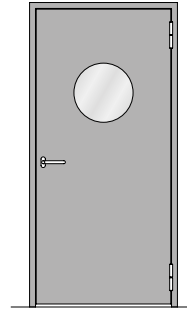
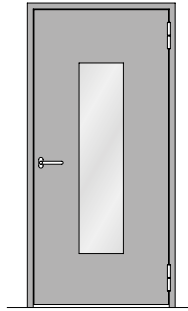
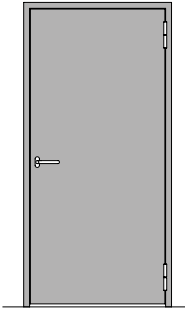

Für Festverglasungen gelten nationale Zulassungen.

Les homologations nationales s'appliquent aux vitrages fixes.

National approvals apply to fixed glazing.

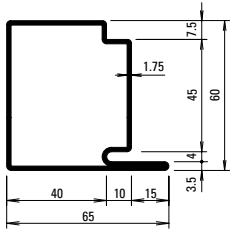

30.019
30.019 Z

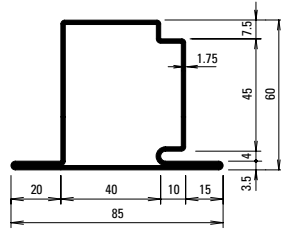

30.119
30.119 Z

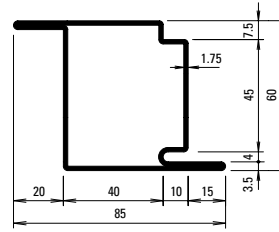

30.419
30.419 Z

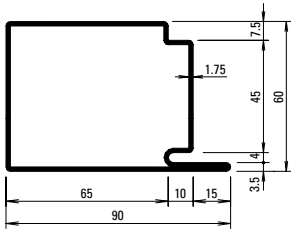

30.017
30.017 Z

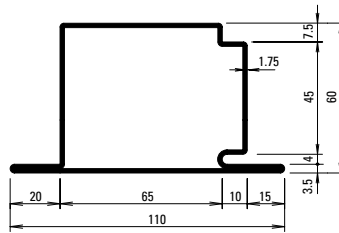

30.117
30.117 Z

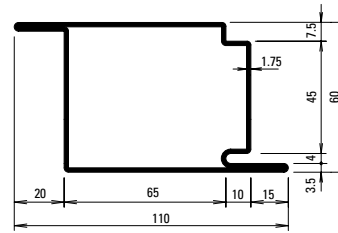

30.415

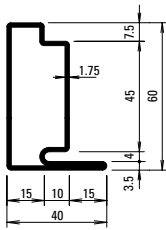

30.018
30.018 Z

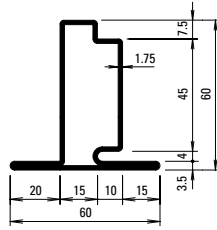

30.118
30.118 Z

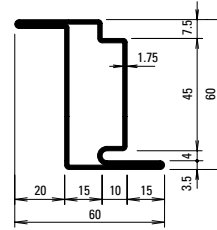

30.418
30.418 Z

Oberfläche/Werkstoff

Artikel-Nr.

ohne Zusatz = blank

mit Z = bandverzinkter Stahl

Surface/Matériau

No. d'article

sans supplément = brut

avec Z = bande d'acier zinguée

Surface/Material

Part no.

without addition = bright

with Z = strip galvanised steel

Profil-Nr.	G kg/m	F cm ²	I _x cm ⁴	W _x cm ³	I _y cm ⁴	W _y cm ³	U m ² /m
30.017	4,190	5,33	31,17	9,04	48,34	10,30	0,310
30.018	2,830	3,61	15,96	4,36	4,77	1,93	0,212
30.019	3,517	4,48	23,69	6,71	19,75	5,56	0,262
30.117	4,746	6,05	34,81	9,37	65,86	11,54	0,351
30.118	3,364	4,29	18,64	4,65	8,62	2,76	0,250
30.119	3,486	4,44	23,36	6,08	25,26	5,70	0,301

Profil-Nr.	G kg/m	F cm ²	I _x cm ⁴	W _x cm ³	I _y cm ⁴	W _y cm ³	U m ² /m
30.415	4,746	6,04	37,87	12,33	65,86	11,54	0,351
30.418	3,364	4,29	22,93	7,37	8,62	2,76	0,250
30.419	3,486	4,44	26,49	8,57	25,26	5,70	0,301

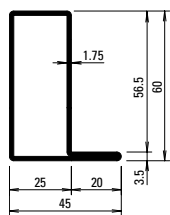

01.634
01.634 Z

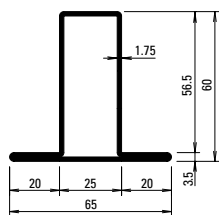

02.634
02.634 Z

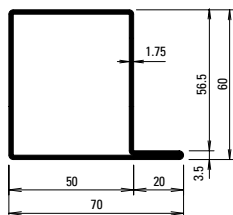

01.684
01.684 Z

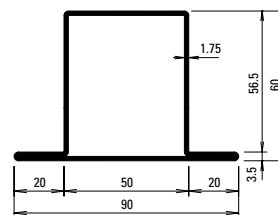

02.684
02.684 Z

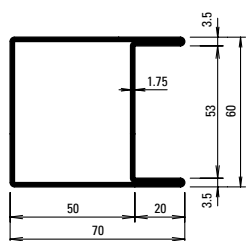

04.637
04.637 Z

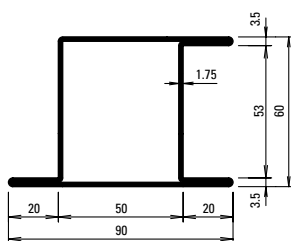

05.637
05.637 Z

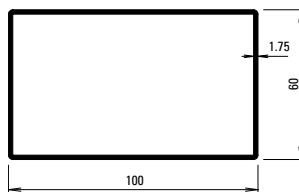

400.051
400.051 Z

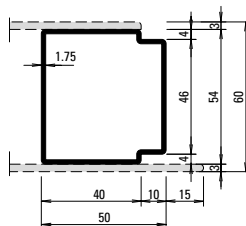

81.010 Z

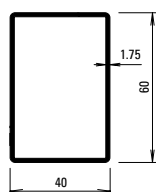

400.052
400.052 Z

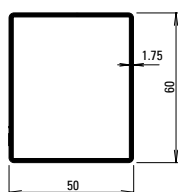

400.054
400.054 Z

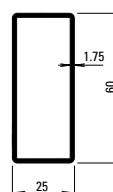

400.055
400.055 Z

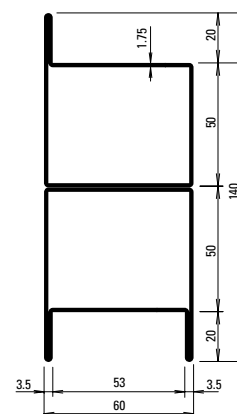

05.001

Profil-Nr.	G kg/m	F cm ²	I _x cm ⁴	W _x cm ³	I _y cm ⁴	W _y cm ³	U m ² /m
01.634	2,729	3,48	16,56	4,66	6,01	2,14	0,204
02.634	3,266	4,16	19,52	4,96	10,33	3,18	0,243
01.684	2,948	3,76	21,13	6,13	19,15	4,84	0,255
02.684	3,412	4,35	24,14	6,41	27,64	6,14	0,294
04.637	3,960	5,05	30,63	10,21	27,46	7,72	0,294
05.637	3,875	4,94	30,92	9,26	34,14	6,94	0,334
81.010	2,696	3,44	14,54	5,38	13,06	5,11	0,202
400.051	4,272	5,44	34,64	11,55	76,01	15,20	0,317
400.052	2,627	3,35	16,87	5,62	8,99	4,49	0,197
400.054	2,901	3,70	19,84	6,61	14,97	5,99	0,217
400.055	2,214	2,82	12,41	4,14	3,09	2,47	0,167

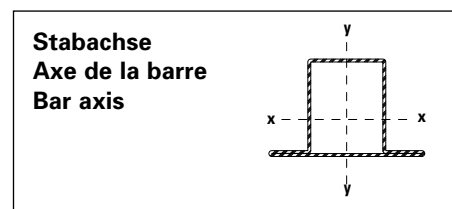

Artikelbibliothek
 Bibliothèque des articles
 Article library

DXF **DWG**

Bogentüren
Portes cintrées
Arched doors

Jansen-Economy 60 RS
 Jansen-Economy 60 RS
 Jansen-Economy 60 RS

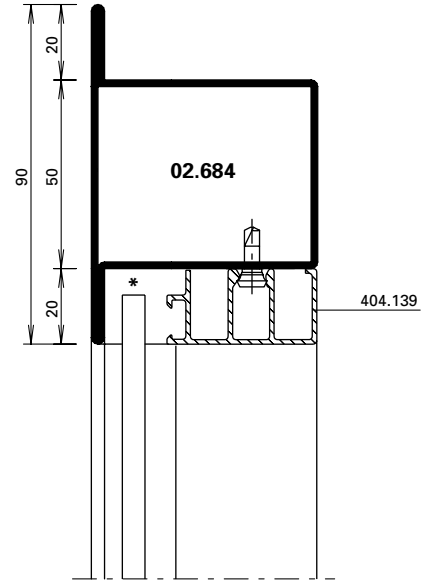
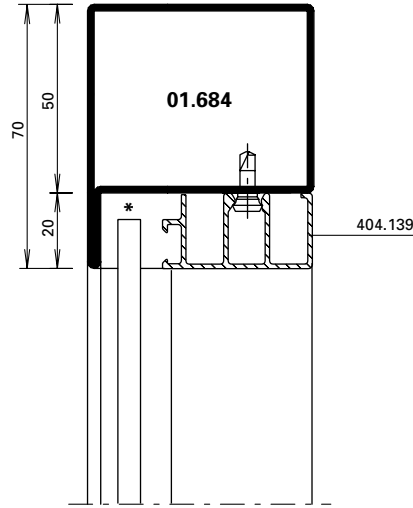
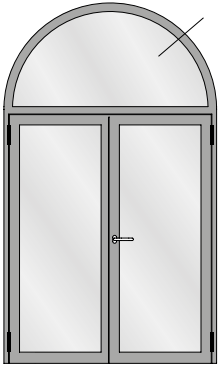

* Füllelemente mit rauchdichtem dauerelastischem Dichtstoff (z.B. 450.092) vollständig in den Glasfalzgrund einkleben.

* Coller entièrement les éléments de remplissage avec produit d'étanchéité à l'élasticité permanente (p.ex. 450.092) dans la feuillure en verre.

* Infill panels with smoke-tight, permanently flexible sealant (e.g. 450.092) fully glued into the glazing rebate platform.

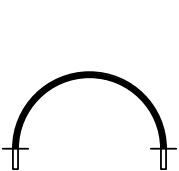

Halbrundbogen
 Arc semi-circulaire
 Semi-circular arch

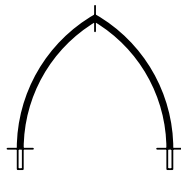

Spitzbogen
 Arc en ogive
 Gothic arch



Stichbogen
 Arc bombé
 Segmented arch



Korbbogen
 Anse de panier
 Oval arch

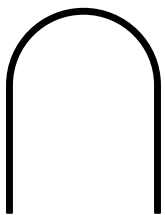

Halbrundbogen mit Schenkel
 Arc surhaussé prolongée
 Semi-circular arch with side extension

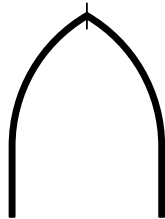

Spitzbogen mit Schenkel
 Arc en ogive prolongée
 Gothic arch with side extension

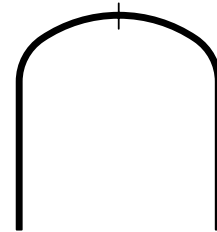



Korbbogen mit Schenkel
 Anse de panier prolongée
 Oval arch with side extension

Bogentüren
Portes cintrées
Arched doors

Jansen-Economy 60 RS
 Jansen-Economy 60 RS
 Jansen-Economy 60 RS

Profil Profilé Profile	Min. Radius Rayon min. Min. radius R	blank brut bright	verzinkt zinguée galvanised
		mm	mm
01.634		550	550
01.684		650	650

		mm	mm
02.634		600	650
02.684		1050	1050

		mm	mm
04.637		1550	1550

		mm	mm
05.637		1550	1550

		mm	mm
400.052		1100	1100
400.054		1000	1000
400.055		800	800
81.010			800

Profil Profilé Profile	Min. Radius Rayon min. Min. radius R	blank brut bright	verzinkt zinguée galvanised
		mm	mm
30.018			550
30.019		650	650

		mm	mm
30.118		800	800
30.119		900	900

		mm	mm
30.418		800	800
30.419		1100	1100

Stahl-Glasleisten Parcloses en acier Steel glazing beads	Min. Radius Rayon min. Min. radius R
--	---

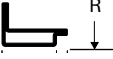
		mm
62.507 Z		300 mm
62.508 Z		300 mm
62.509 Z		300 mm

Stahl-Glasleisten Parcloses en acier Steel glazing beads	Min. Radius Rayon min. Min. radius R	
		mm
402.112 Z		500 mm
402.115 Z		500 mm
402.120 Z		600 mm
402.125 Z		750 mm
402.130 Z		1000 mm
402.135 Z		1500 mm

Aluminium-Glasleisten Parcloses en aluminium Aluminium glazing beads	Min. Radius Rayon min. Min. radius R
--	---

		mm
404.109		400 mm
404.112		400 mm
404.115		400 mm
404.120		400 mm
404.125		450 mm
404.130		500 mm
404.135		600 mm

		mm
405.110		500 mm
405.115		500 mm
405.120		500 mm
405.125		800 mm
405.130		1000 mm
406.903		500 mm
406.905		500 mm
406.907		500 mm
406.909		600 mm

Die Radien-Angaben beziehen sich auf die langjährige Erfahrung und Fertigung im Hause Jansen.

Les rayons indiqués se fondent sur la longue expérience et la fabrication au sein de la maison Jansen.

The radii specifications are based on the many years of experience Jansen has in fabrication.

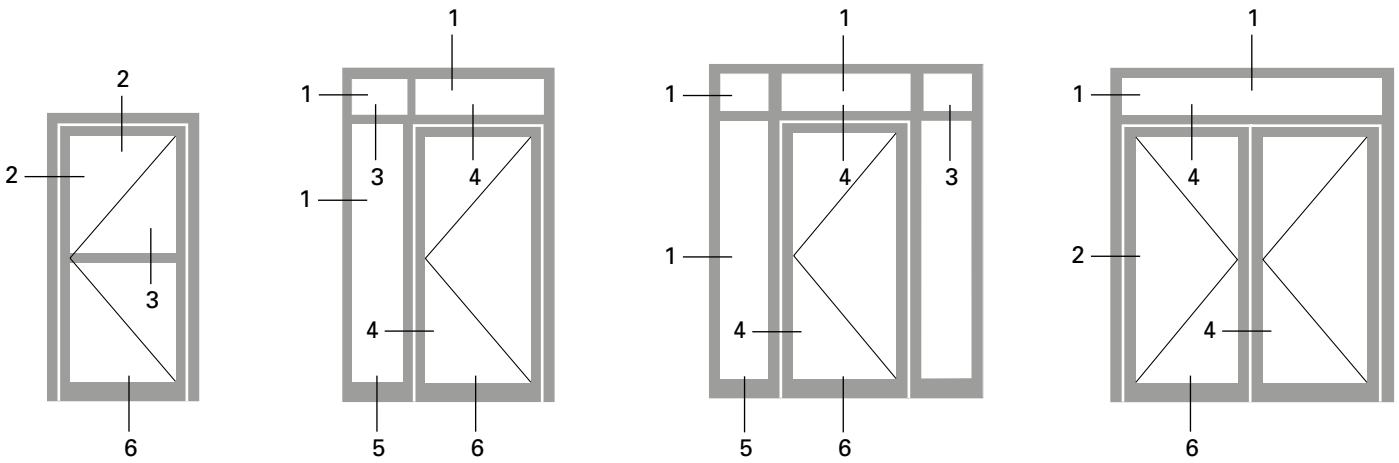

3.0

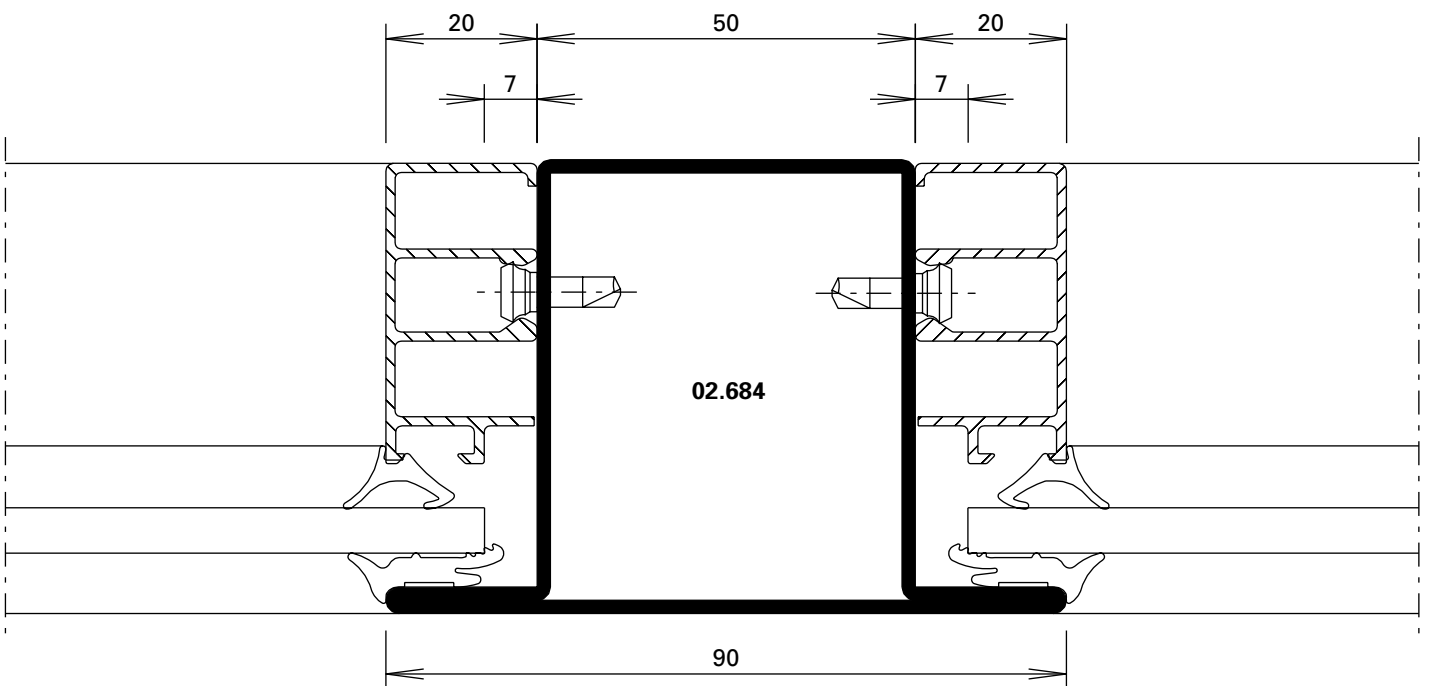

DXF DWG 41-0301-C-007

2.0

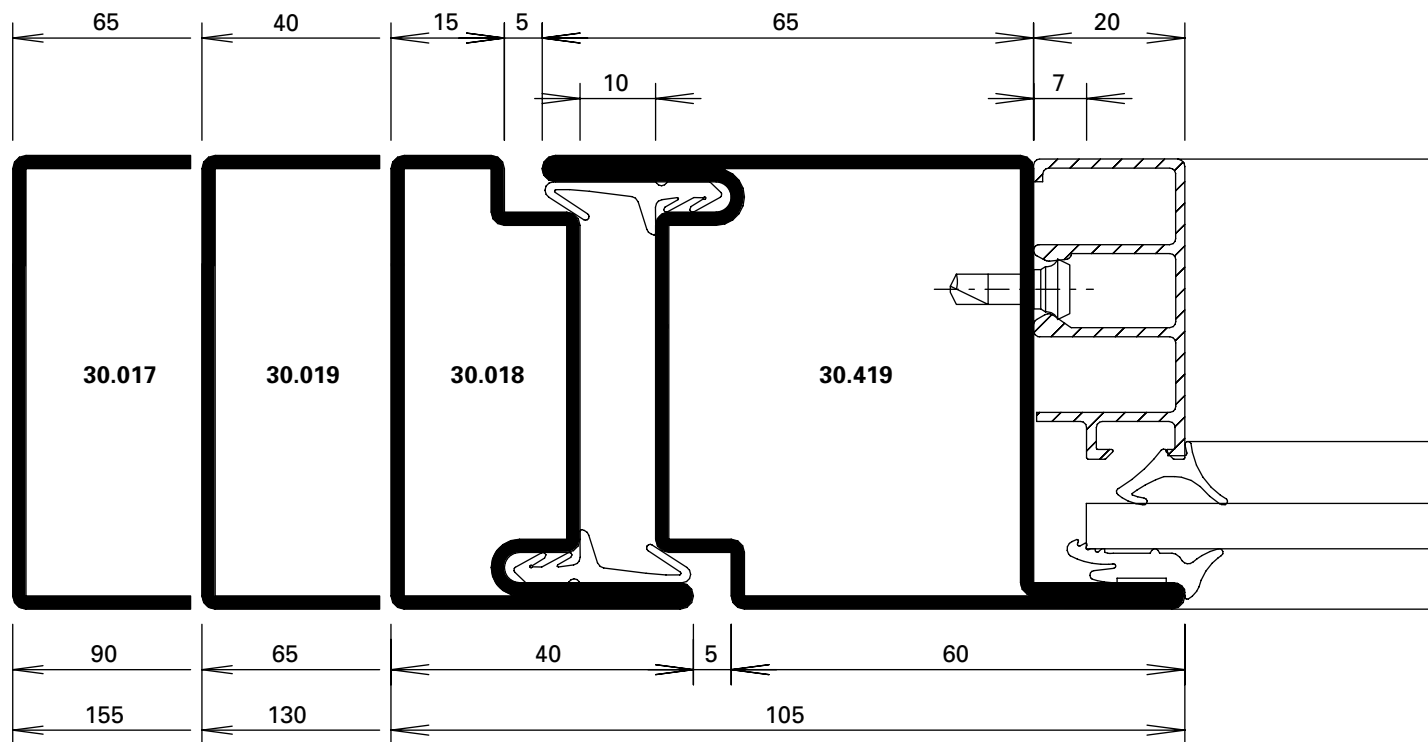

DXF **DWG** 41-0301-C-004

4.0

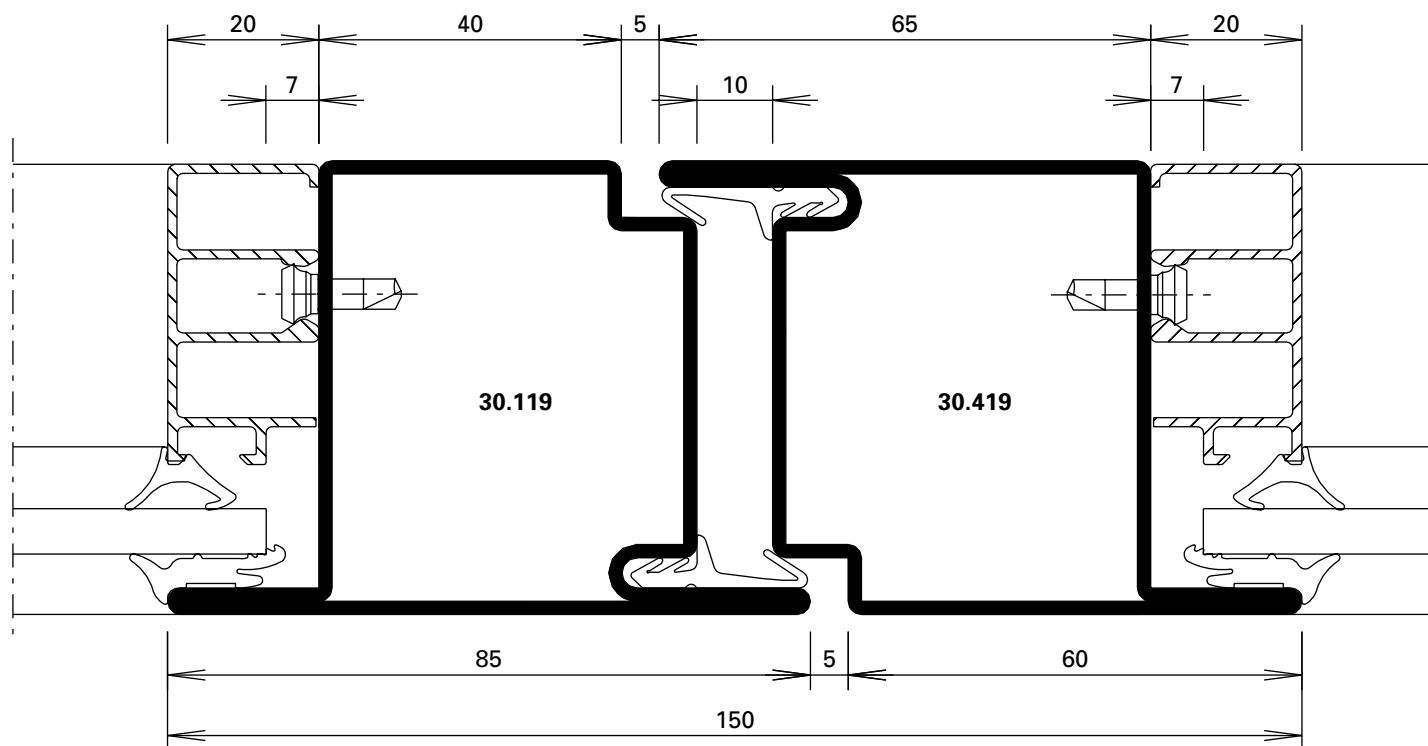

DXF **DWG** 41-0301-C-008

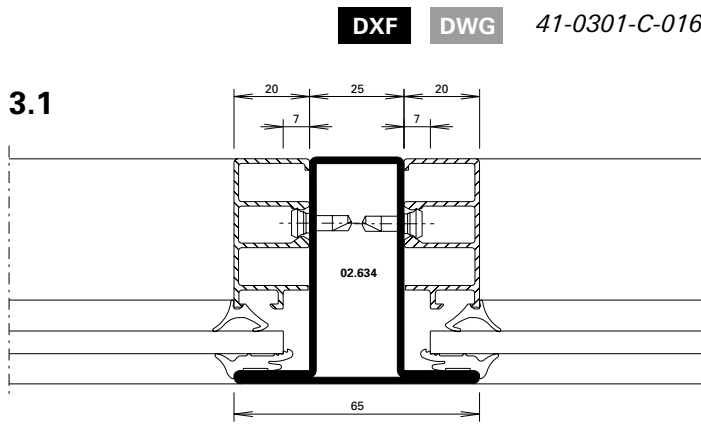
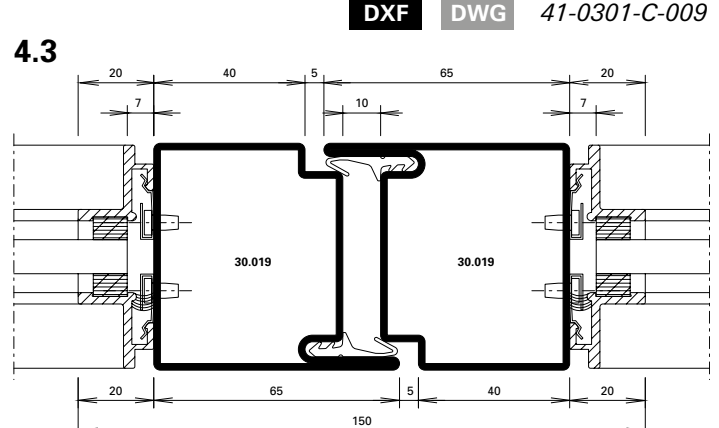
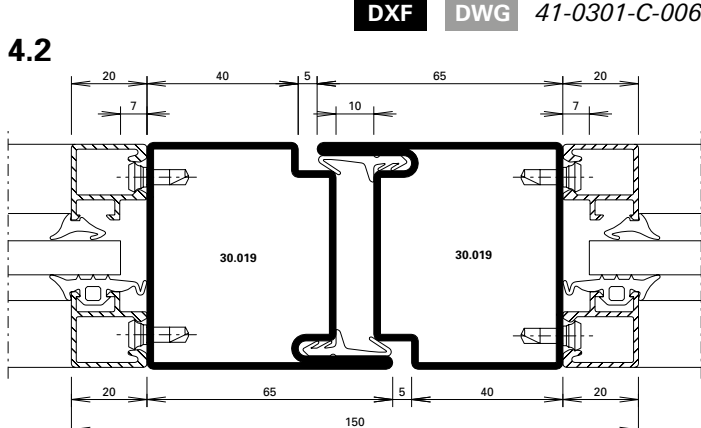
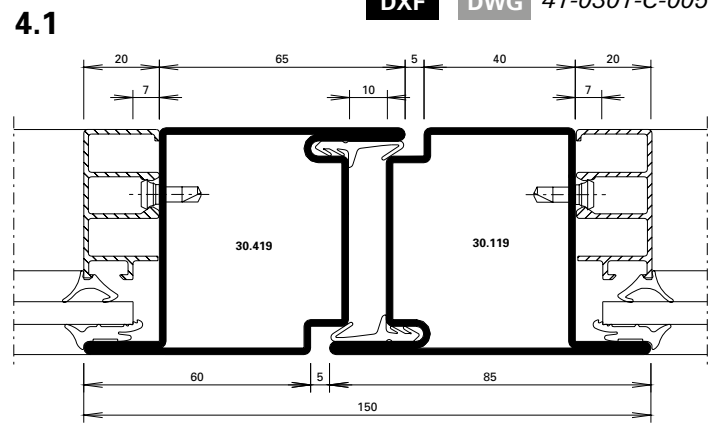
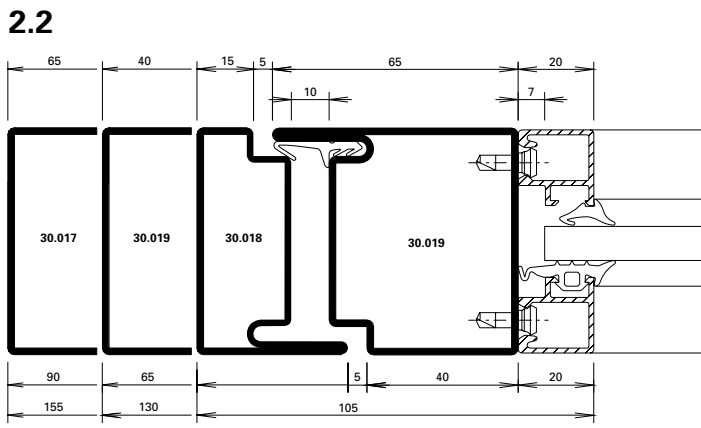
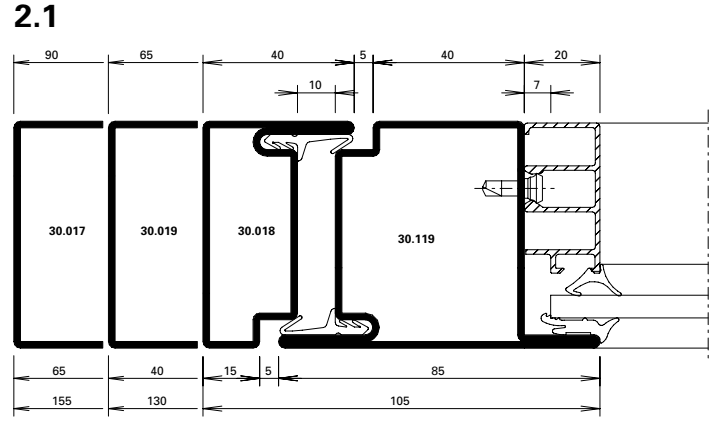
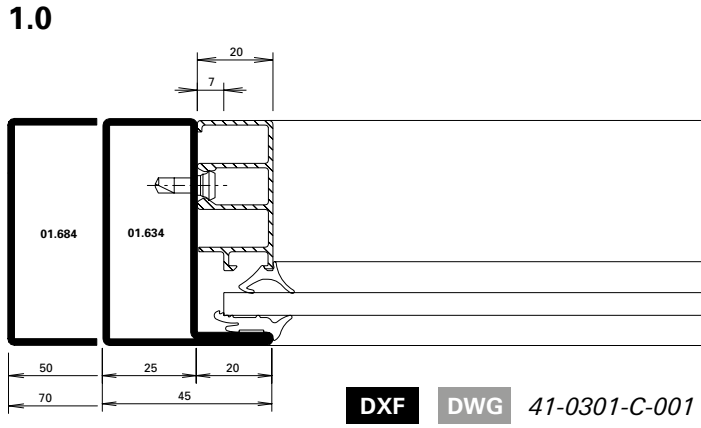

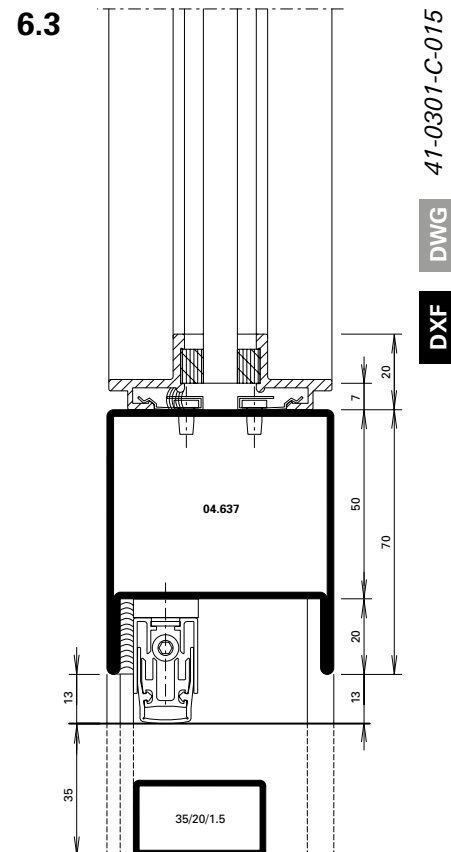
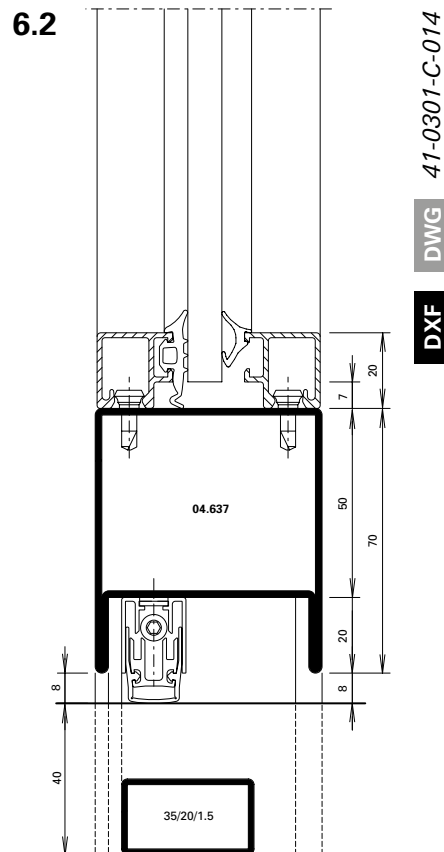
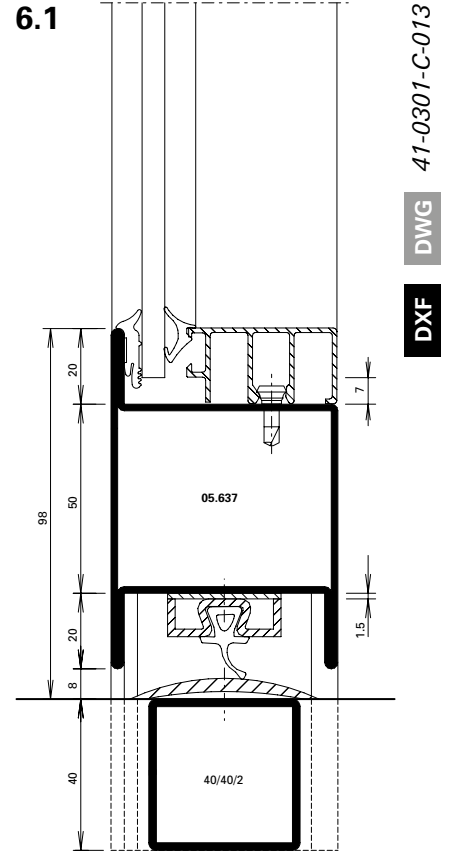
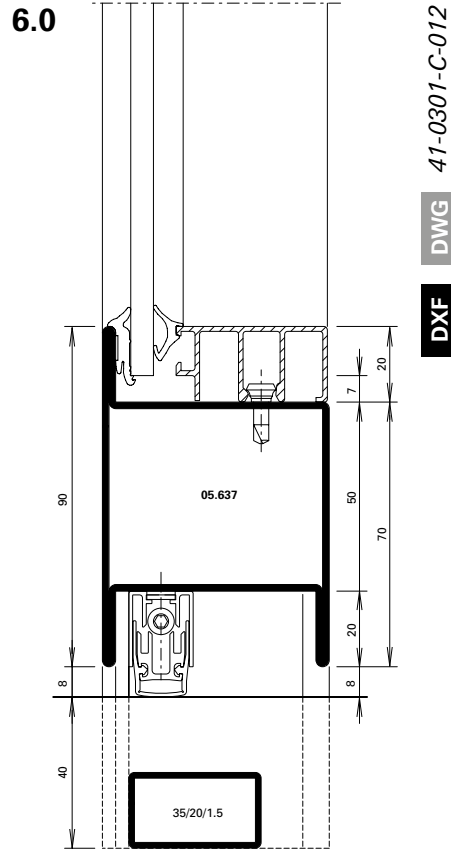
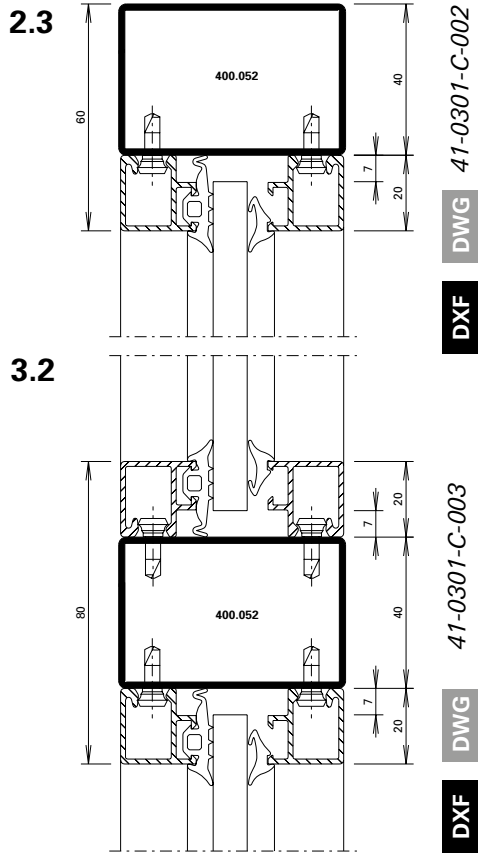

Glasleisten-Varianten im Masstab 1:2
Variantes de parcloses à l'échelle 1:2
Glazing bead options on scale 1:2

Jansen-Economy 60 RS
 Jansen-Economy 60 RS
 Jansen-Economy 60 RS

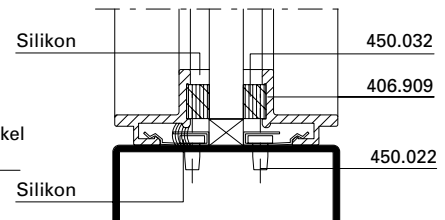
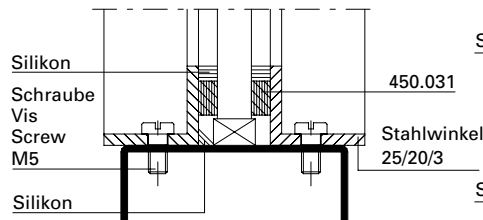
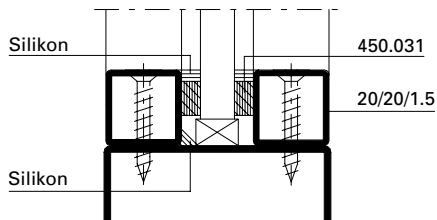
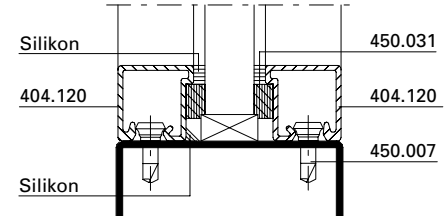
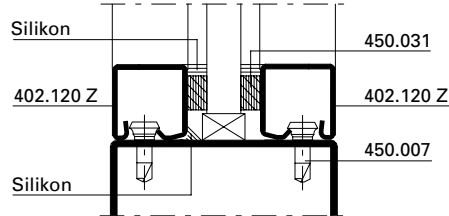
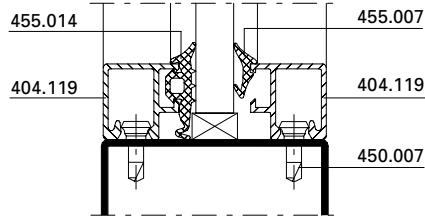
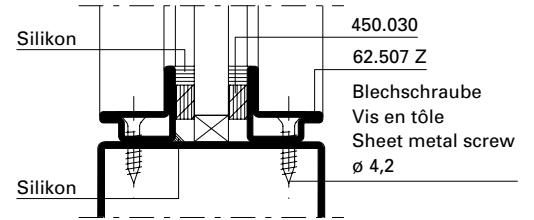
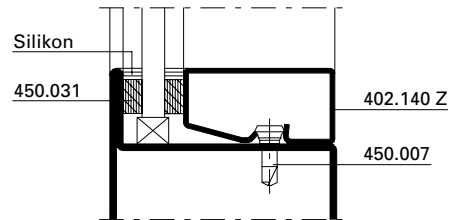
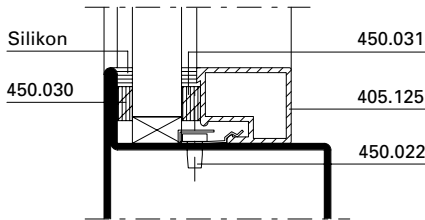
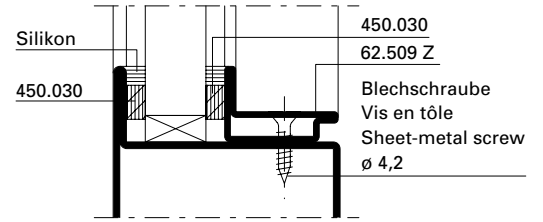
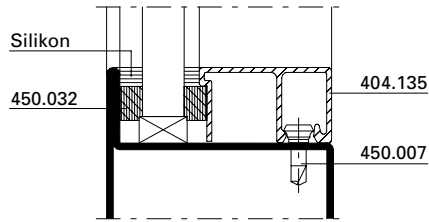
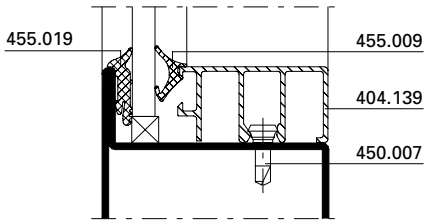

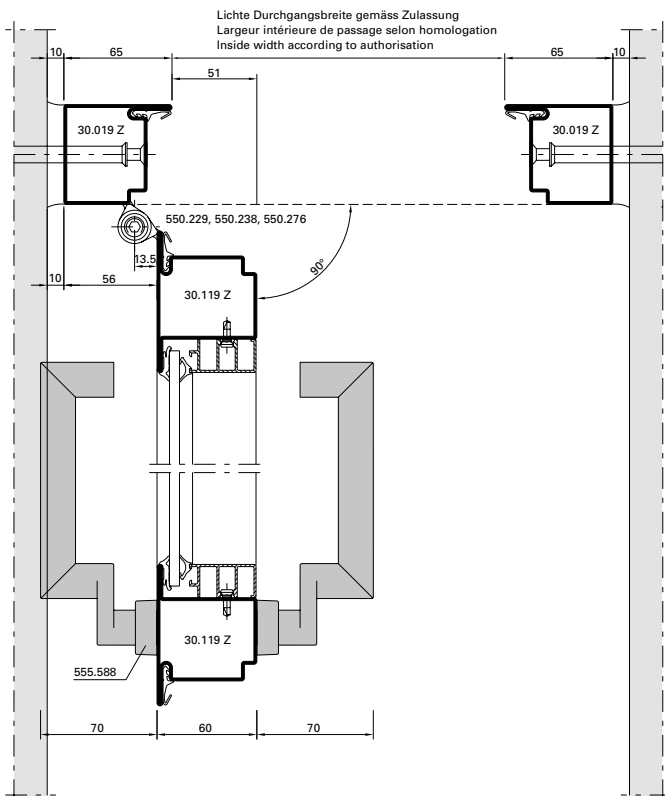

DXF DWG 41-0301-E-013

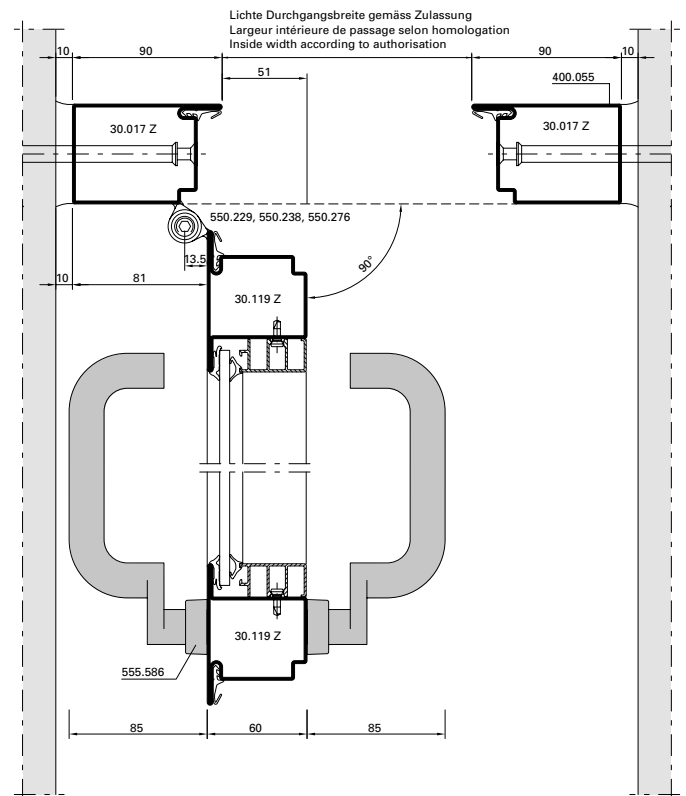

DXF DWG 41-0301-E-014

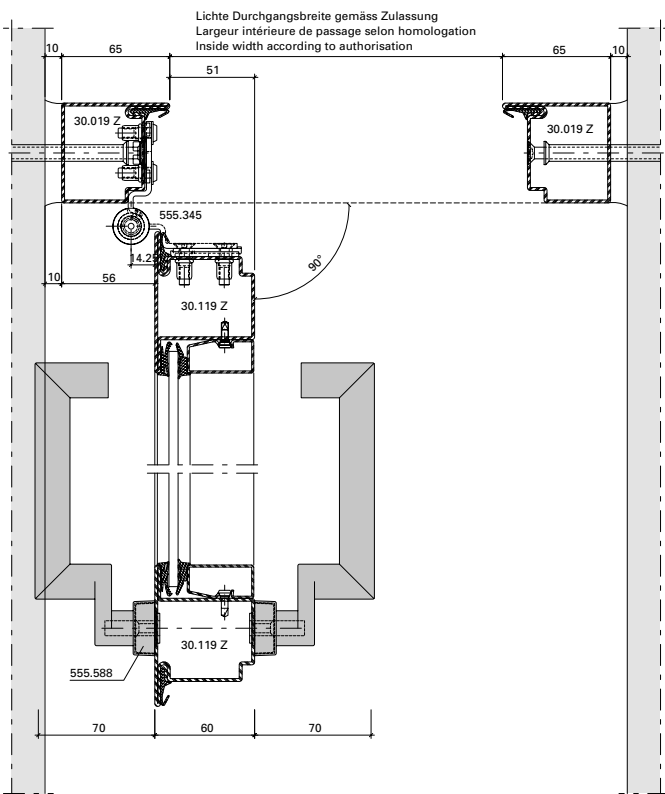

DXF DWG 41-0301-E-015

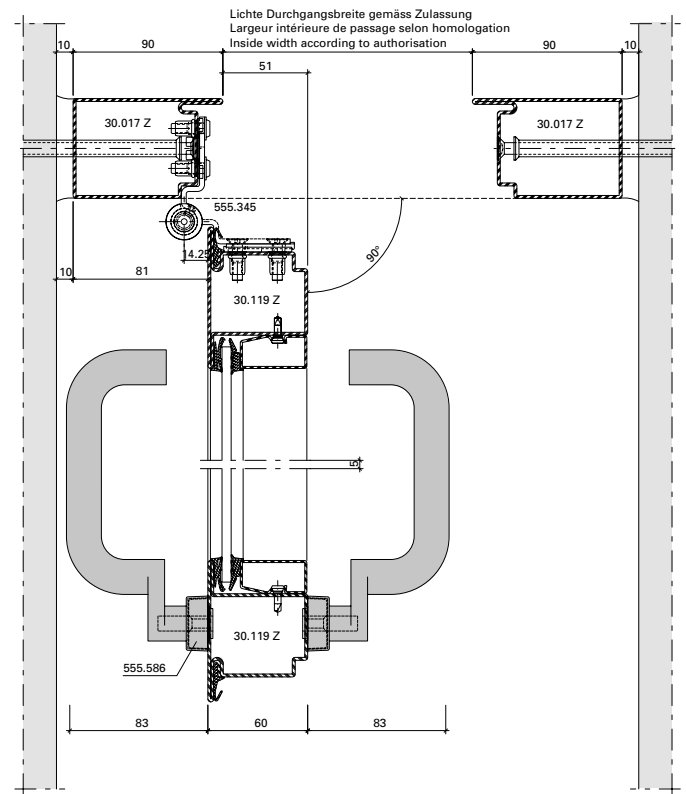

DXF DWG 41-0301-E-016

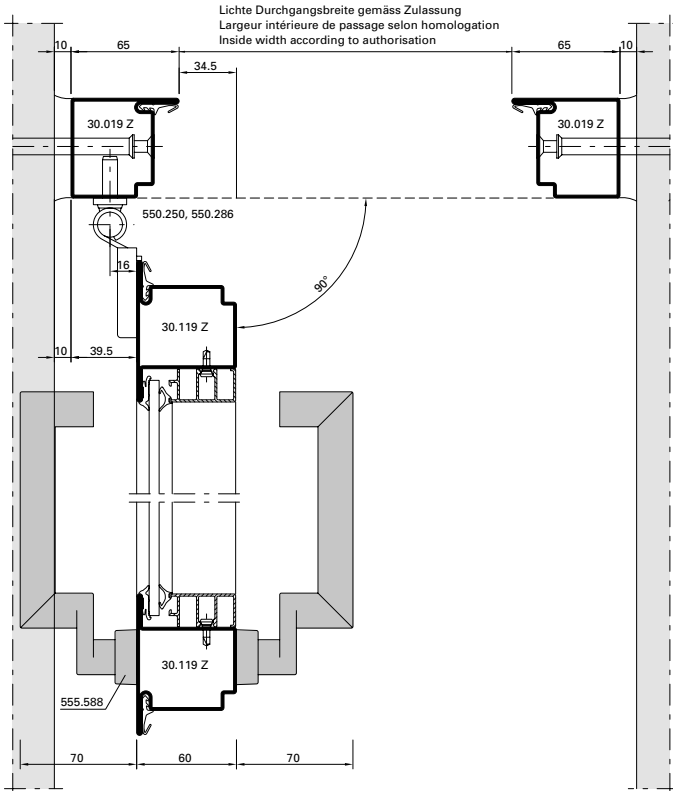

DXF **DWG** 41-0301-E-017

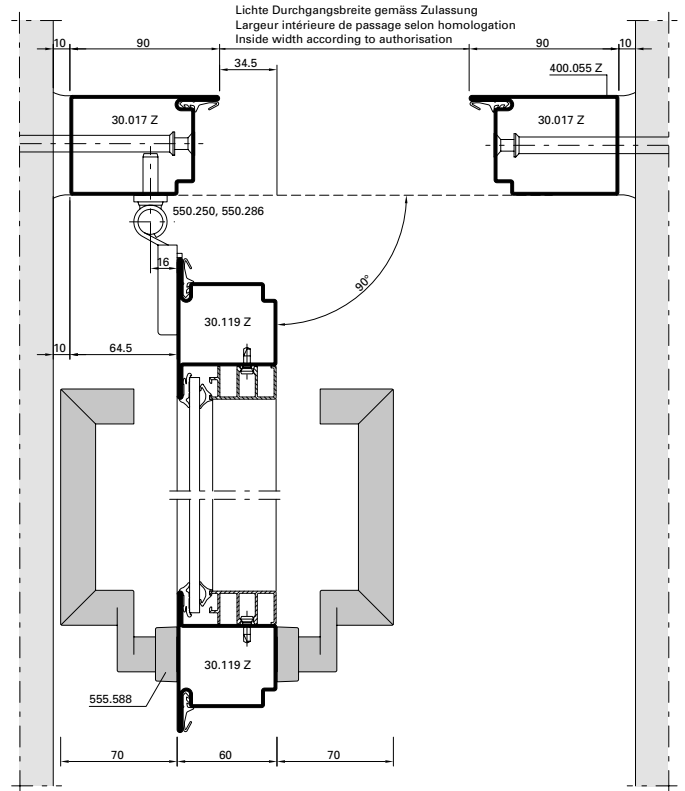

DXF **DWG** 41-0301-E-018

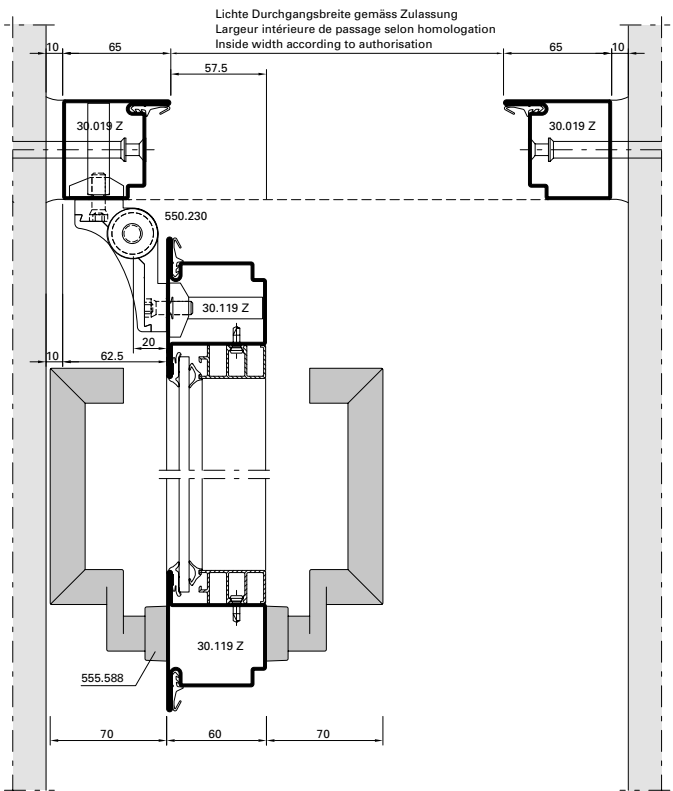

DXF **DWG** 41-0301-E-019

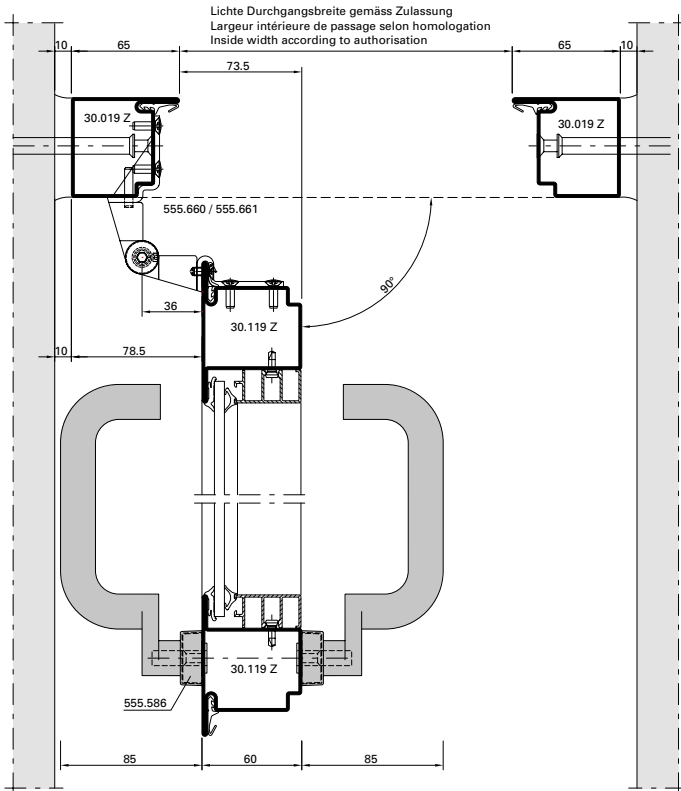

DXF **DWG** 41-0301-E-023

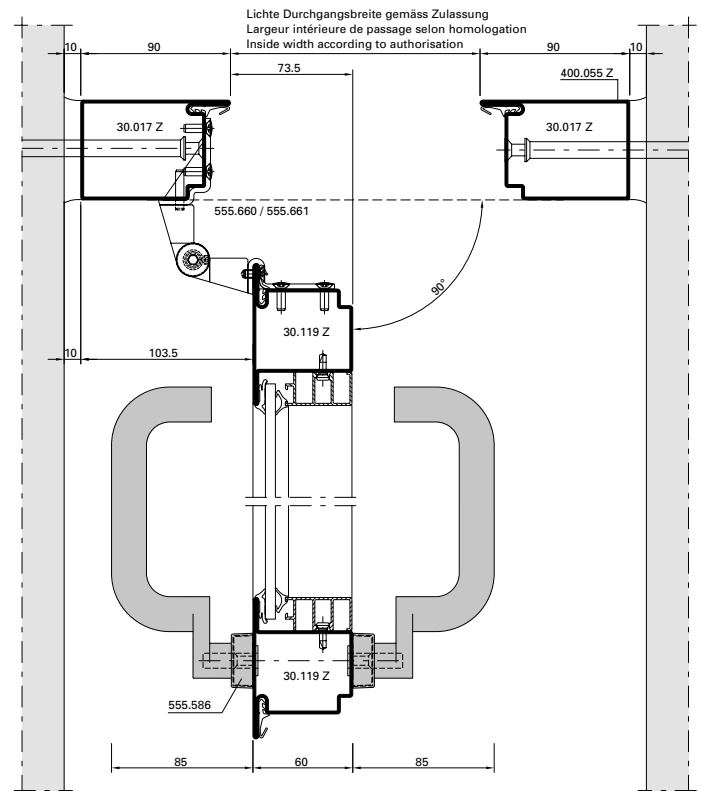

DXF **DWG** 41-0301-E-022

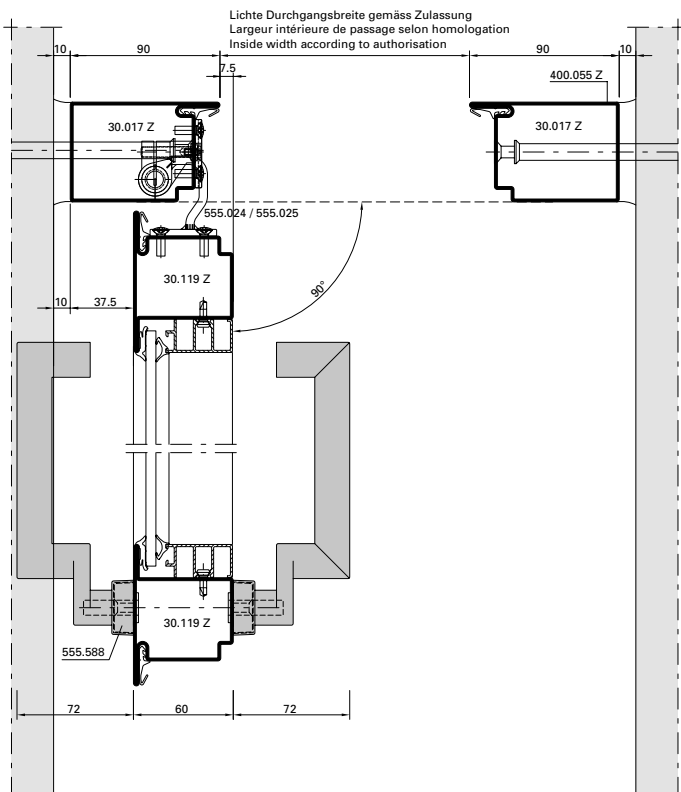

DXF **DWG** 41-0301-E-021

Anschlüsse am Bau im Massstab 1:2
Raccords au mur à l'échelle 1:2
Attachment to structure on scale 1:2

Jansen-Economy 60 RS
Jansen-Economy 60 RS
Jansen-Economy 60 RS

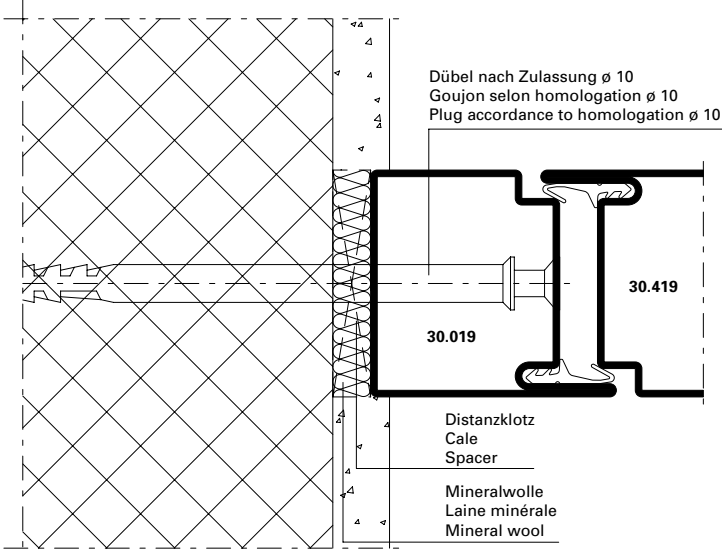

DXF DWG 41-0301-A-014

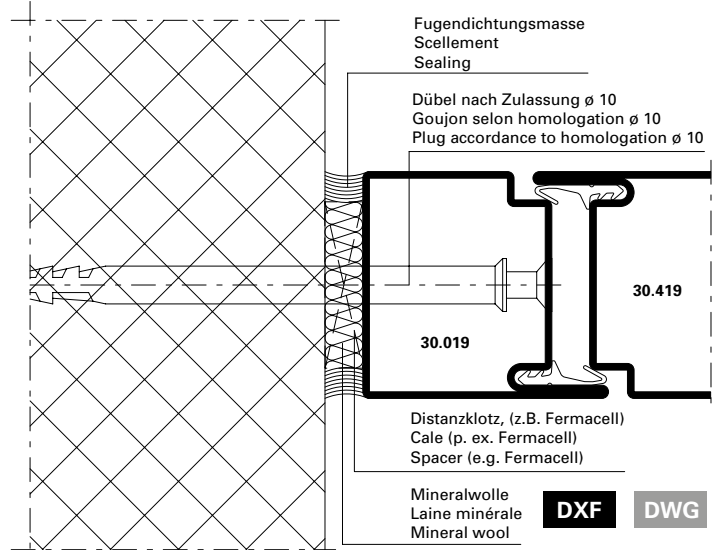

DXF DWG

41-0301-A-015

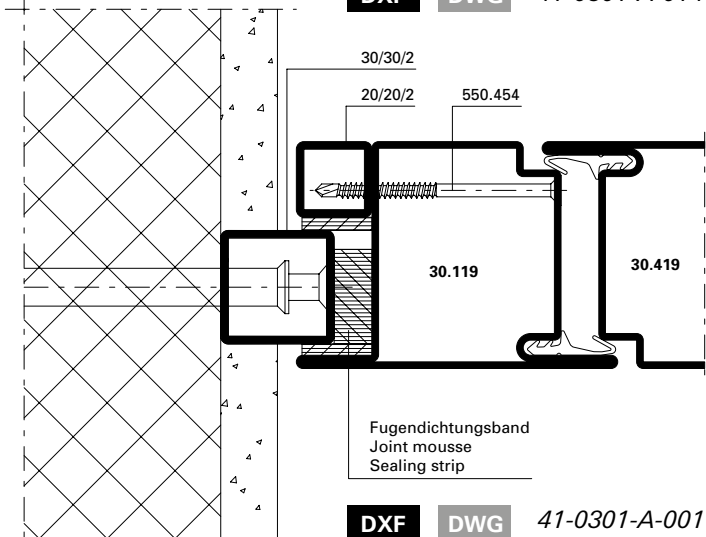

DXF DWG 41-0301-A-001

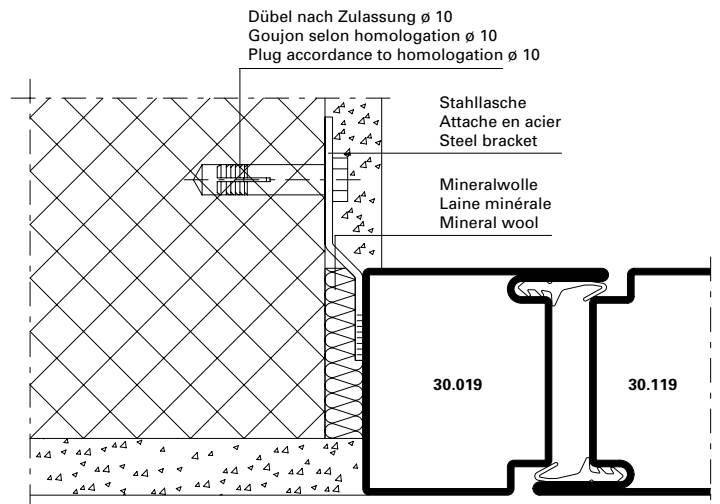

DXF DWG 41-0301-A-002

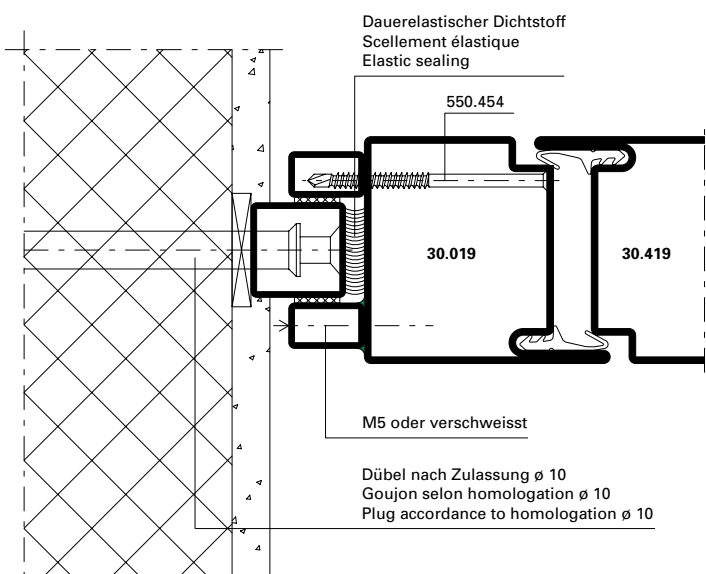

DXF DWG 41-0301-A-003

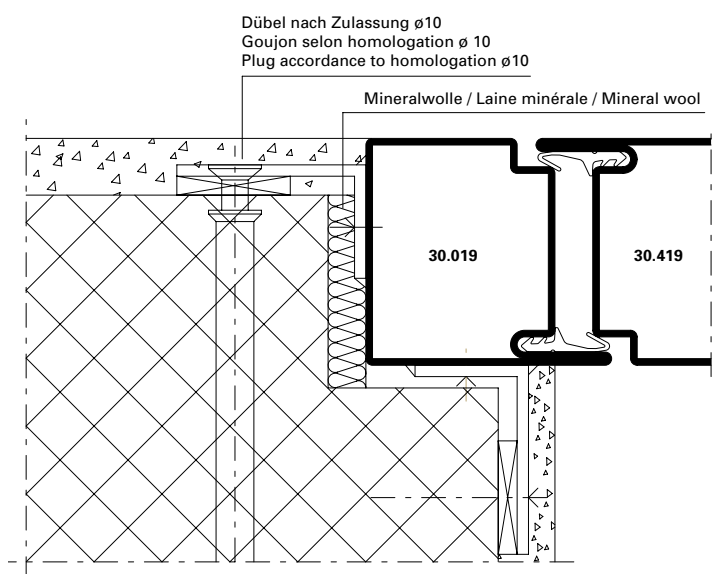

DXF DWG 41-0301-A-016

Anschlüsse am Bau im Masstab 1:2
Raccords au mur à l'échelle 1:2
Attachment to structure on scale 1:2

Jansen-Economy 60 RS
 Jansen-Economy 60 RS
 Jansen-Economy 60 RS

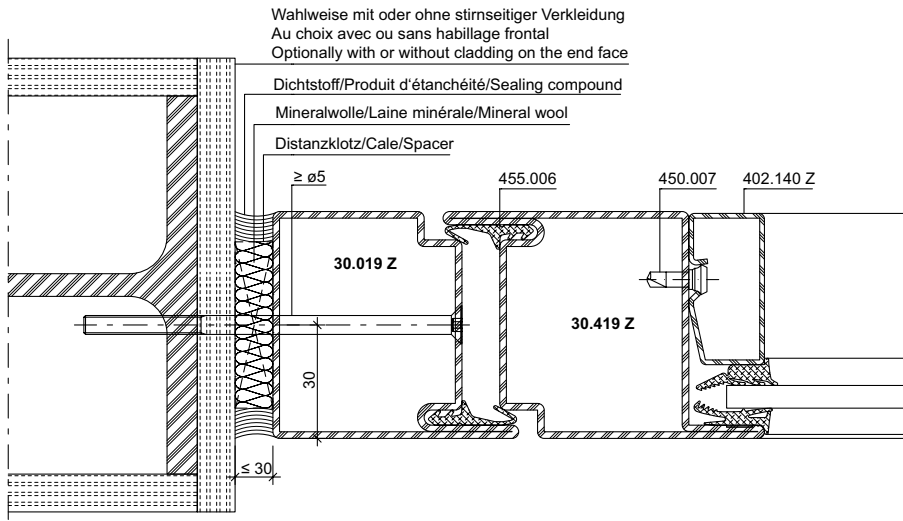

DXF **DWG** 41-0301-A-004

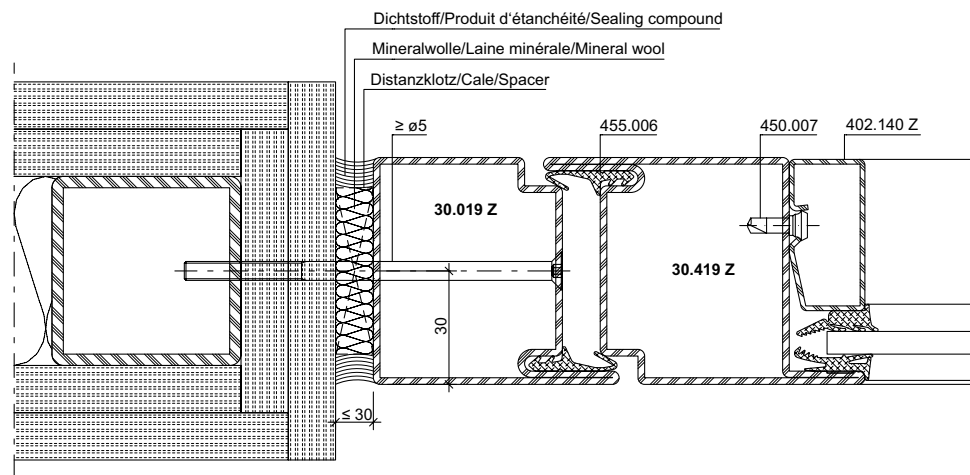

DXF **DWG** 41-0301-A-006

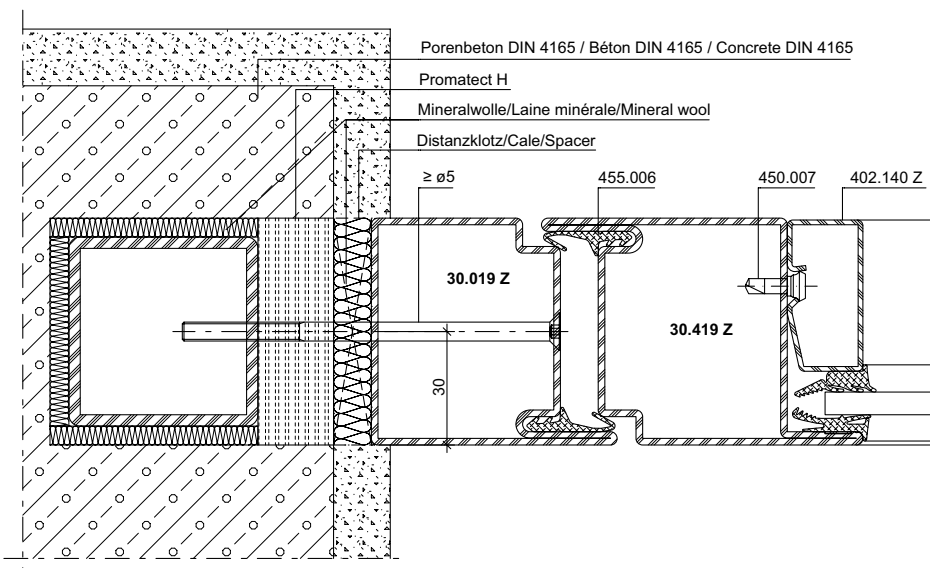

DXF **DWG** 41-0301-A-008

Anschlüsse am Bau im Massstab 1:2

Raccords au mur à l'échelle 1:2

Attachment to structure on scale 1:2

Jansen-Economy 60 RS

Jansen-Economy 60 RS

Jansen-Economy 60 RS

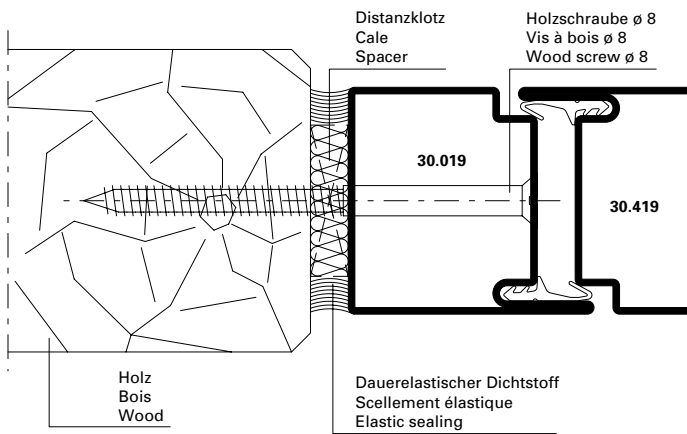

DXF **DWG** 41-0301-A-005

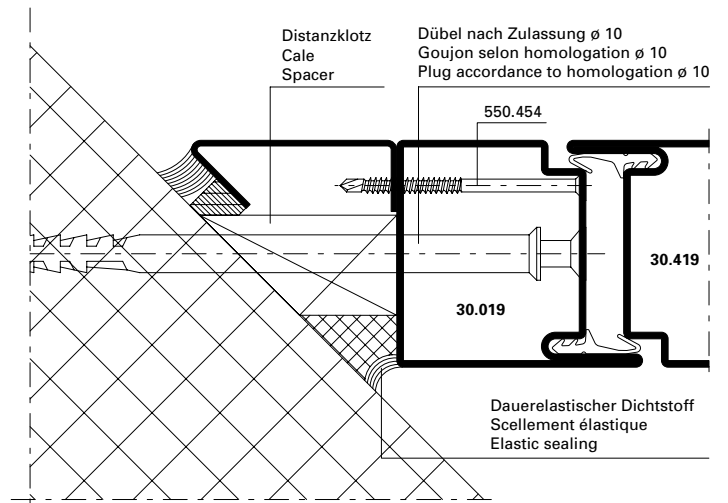

DXF **DWG** 41-0301-A-007

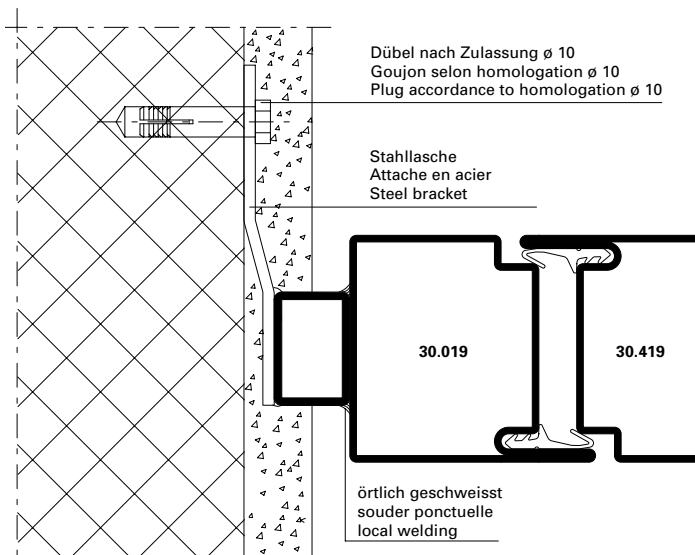

DXF **DWG** 41-0301-A-009

41-0301-A-011

DXF DWG

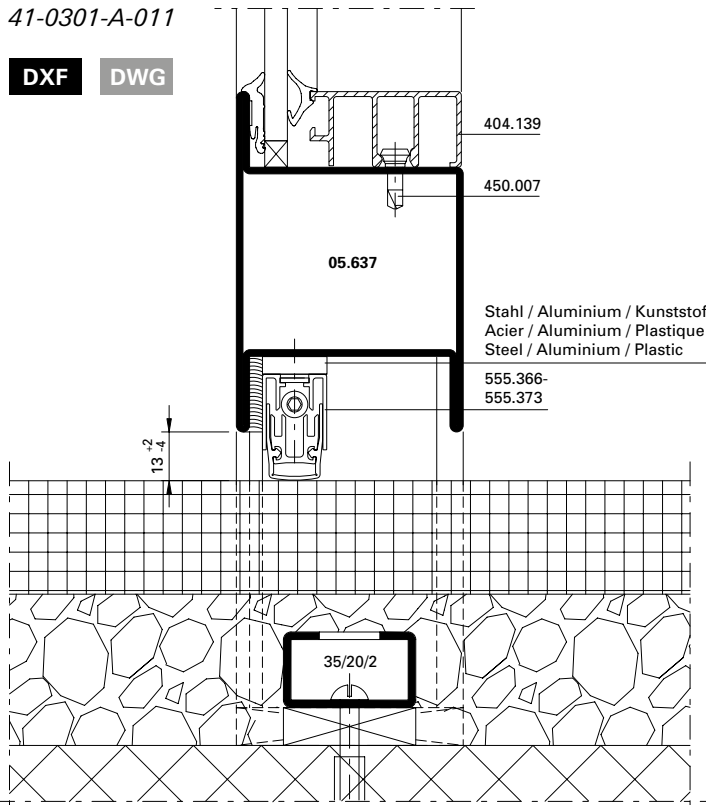

41-0301-A-013

DXF DWG

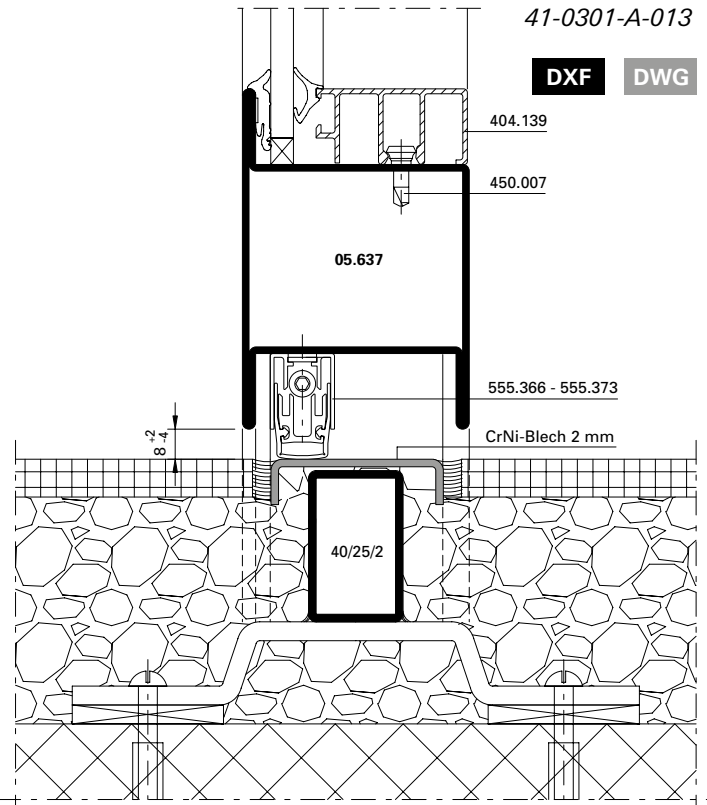

41-0301-A-010

DXF DWG

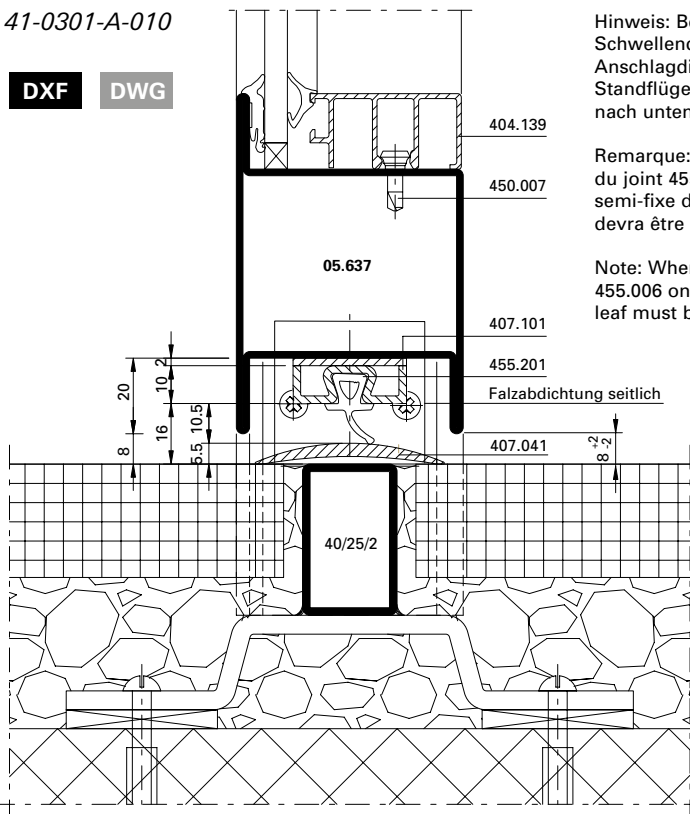

Hinweis: Bei Verwendung der Schwelldichtung 455.201 oder Anschlagdichtung 455.006 muss der Standflügel von zweiflügeligen Türen nach unten verriegelt werden.

Remarque: Dans le cas de l'utilisation du joint 455.201 ou 455.006, le vantail semi-fixe des portes à deux vantaux devra être verrouillé aussi en bas.

Note: When using gasket 455.201 or 455.006 on two leaf doors the fixed leaf must be locked towards the bottom.

41-0301-A-012

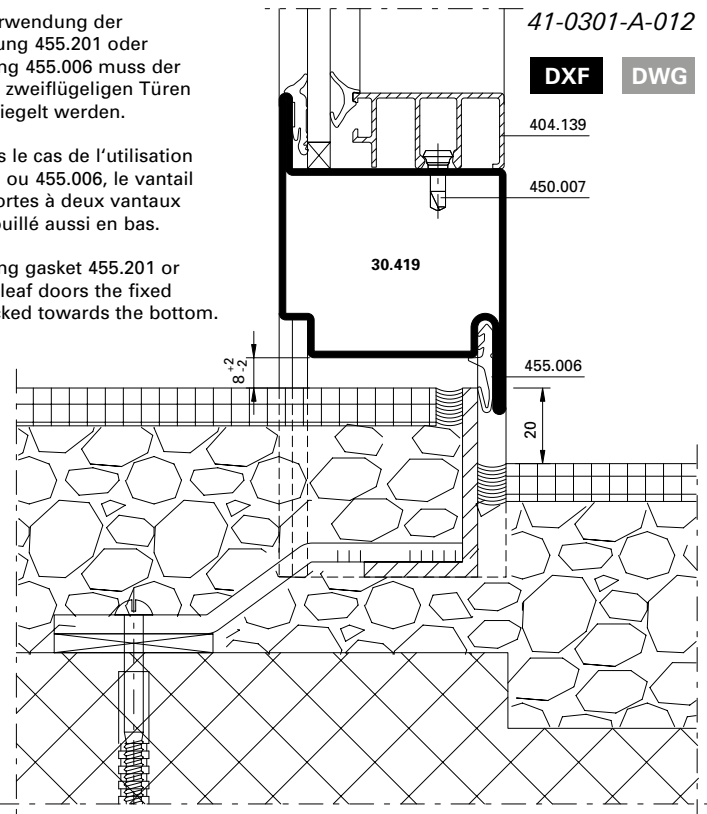

DXF DWG



Einflügelige Türen,
 auswärts öffnend,
 Flügelhöhe ≤ 2200 mm

Porte à un vantail,
 ouvrant vers l'extérieur,
 hauteur du vantail ≤ 2200 mm

Single leaf door,
 outward opening,
 leaf height ≤ 2200 mm

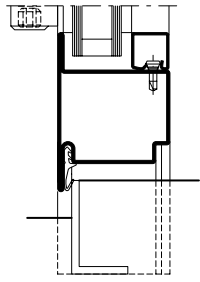
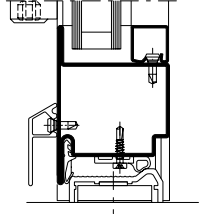
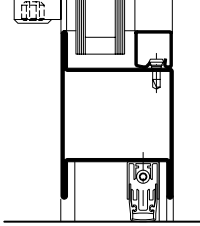
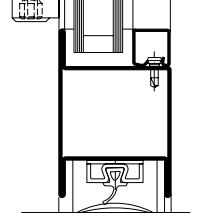
Variante	Beschlag Ferrure Fitting	 EN 12207	 EN 12208	 EN 12210
Anschlagdichtung Joint de butée Rebate gasket 	1	2	1A	C4
	2	2	2A	C4
	3	3	2A	C5
Doppel-Anschlagdichtung Joint de base double Double rebate gasket 	1	4	3A	C4
	2	4	3A	C4
	3	4	5A	C5
Senkdichtung Joint seuil Drop seal 	1	2	1A	C4
	2	2	2A	C4
	3	3	2A	C5
Auflaufdichtung Joint de contact Ramp seal 	1	2	0	C4
	2	2	0	C4
	3	2	0	C5

1 Fallenriegel-Schloss
 Serrure à mortaiser
 Latch and bolt lock





2 Schloss mit Obenverriegelung
 Serrure avec verrouillage supérieur
 Lock with top locking point

3 Mehrfachverriegelungs-Schloss
 Serrure à verrouillage multiple
 Multipoint lock

Einflügelige Türen,
 einwärts öffnend,
 Flügelhöhe ≤ 2200 mm

Porte à un vantail,
 ouvrant vers l'intérieur,
 hauteur du vantail ≤ 2200 mm

Single leaf door,
 inward opening,
 leaf height ≤ 2200 mm

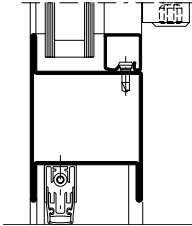
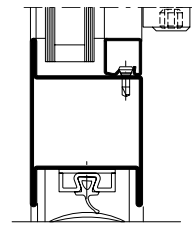
Variante		Beschlag Ferrure Fitting	 EN 12207	 EN 12208	 EN 12210
Senkdichtung Joint seuil Drop seal		❶	2	0	C4
		❷	2	0	C4
		❸	3	1A	C5
Auflaufdichtung Joint de contact Ramp seal		❶	2	0	C4
		❷	2	0	C4
		❸	2	0	C5

❶ Fallenriegel-Schloss
 Serrure à mortaiser
 Latch and bolt lock



❷ Schloss mit Obenverriegelung
 Serrure avec verrouillage supérieur
 Lock with top locking point

❸ Mehrfachverriegelungs-Schloss
 Serrure à verrouillage multiple
 Multipoint lock

Einflügelige Türen,
 auswärts öffnend,
 Flügelhöhe ≤ 3000 mm

Porte à un vantail,
 ouvrant vers l'extérieur,
 hauteur du vantail ≤ 3000 mm

Single leaf door,
 outward opening,
 leaf height ≤ 3000 mm

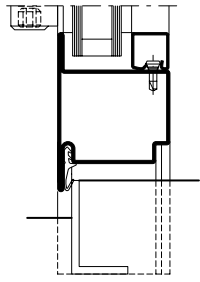
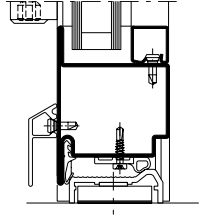
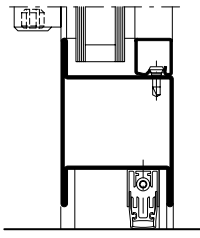
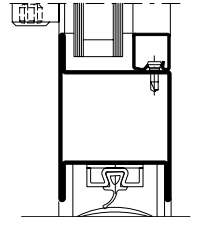
Variante	Beschlag Ferrure Fitting	 EN 12207	 EN 12208	 EN 12210	
Anschlagdichtung Joint de butée Rebate gasket		1	1	0	C1
		2	1	0	C1
		3	1	0	C2
Doppel-Anschlagdichtung Joint de base double Double rebate gasket		1	1	1A	C1
		2	1	1A	C1
		3	2	2A	C2
Senkdichtung Joint seuil Drop seal		1	1	0	C1
		2	1	0	C1
		3	1	0	C2
Auflaufdichtung Joint de contact Ramp seal		1	0	0	C1
		2	0	0	C1
		3	1	0	C2

1 Fallenriegel-Schloss
 Serrure à mortaiser
 Latch and bolt lock





2 Schloss mit Obenverriegelung
 Serrure avec verrouillage supérieur
 Lock with top locking point

3 Mehrfachverriegelungs-Schloss
 Serrure à verrouillage multiple
 Multipoint lock

Einflügelige Türen,
 einwärts öffnend,
 Flügelhöhe ≤ 3000 mm

Porte à un vantail,
 ouvrant vers l'intérieur,
 hauteur du vantail ≤ 3000 mm

Single leaf door,
 inward opening,
 leaf height ≤ 3000 mm

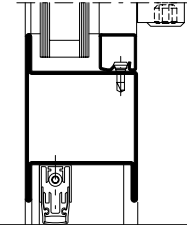
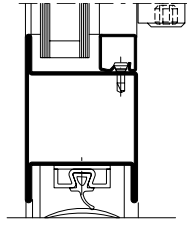
Variante		Beschlag Ferrure Fitting	 EN 12207	 EN 12208	 EN 12210
Senkdichtung Joint seuil Drop seal		❶	1	0	C1
		❷	1	0	C1
		❸	1	0	C2
Auflaufdichtung Joint de contact Ramp seal		❶	0	0	C1
		❷	0	0	C1
		❸	1	0	C2

❶ Fallenriegel-Schloss
 Serrure à mortaiser
 Latch and bolt lock



❷ Schloss mit Obenverriegelung
 Serrure avec verrouillage supérieur
 Lock with top locking point

❸ Mehrfachverriegelungs-Schloss
 Serrure à verrouillage multiple
 Multipoint lock

Zweiflügelige Türen,
 auswärts öffnend,
 Flügelhöhe ≤ 2200 mm

Porte à deux vantaux,
 ouvrant vers l'extérieur,
 hauteur du vantail ≤ 2200 mm

Double leaf door,
 outward opening,
 leaf height ≤ 2200 mm

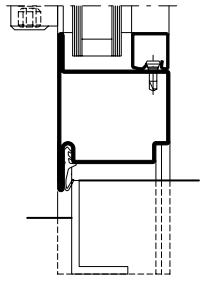
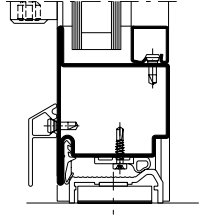
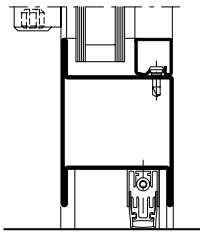
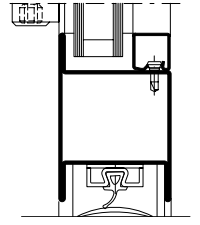
Variante	Beschlag Ferrure Fitting	 EN 12207	 EN 12208	 EN 12210
Anschlagdichtung Joint de butée Rebate gasket 	1	2	1A	C2
	2	2	2A	C2
	3	2	2A	C3
Doppel-Anschlagdichtung Joint de base double Double rebate gasket 	1	2	2A	C2
	2	2	2A	C2
	3	3	3A	C3
Senkdichtung Joint seuil Drop seal 	1	2	1A	C2
	2	2	2A	C2
	3	2	2A	C3
Auflaufdichtung Joint de contact Ramp seal 	1	2	0	C2
	2	2	0	C2
	3	2	0	C3

1 Fallenriegel-Schloss
 Serrure à mortaiser
 Latch and bolt lock





2 Schloss mit Obenverriegelung
 Serrure avec verrouillage supérieur
 Lock with top locking point

3 Mehrfachverriegelungs-Schloss
 Serrure à verrouillage multiple
 Multipoint lock

Zweiflügelige Türen,
 einwärts öffnend,
 Flügelhöhe ≤ 2200 mm

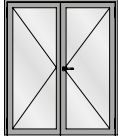
Porte à deux vantaux,
 ouvrant vers l'intérieur,
 hauteur du vantail ≤ 2200 mm

Double leaf door,
 inward opening,
 leaf height ≤ 2200 mm

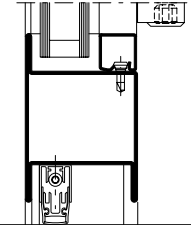
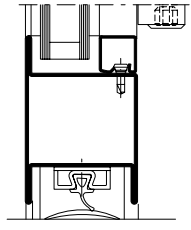
Variante		Beschlag Ferrure Fitting	 EN 12207	 EN 12208	 EN 12210
Senkdichtung Joint seuil Drop seal		❶	2	0	C2
		❷	2	0	C2
		❸	2	0	C3
Auflaufdichtung Joint de contact Ramp seal		❶	2	0	C2
		❷	2	0	C2
		❸	2	0	C3

❶ Fallenriegel-Schloss
 Serrure à mortaiser
 Latch and bolt lock



❷ Schloss mit Obenverriegelung
 Serrure avec verrouillage supérieur
 Lock with top locking point

❸ Mehrfachverriegelungs-Schloss
 Serrure à verrouillage multiple
 Multipoint lock

Zweiflügelige Türen,
 auswärts öffnend,
 Flügelhöhe ≤ 3000 mm

Porte à deux vantaux,
 ouvrant vers l'extérieur,
 hauteur du vantail ≤ 3000 mm

Double leaf door,
 outward opening,
 leaf height ≤ 3000 mm

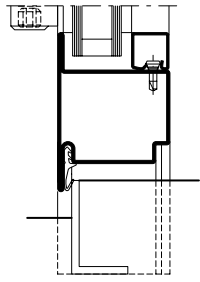
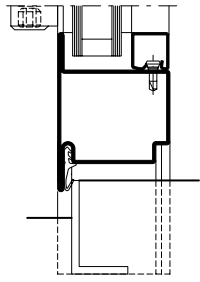
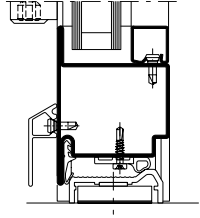
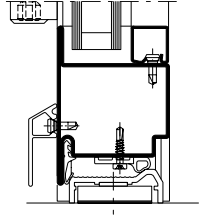
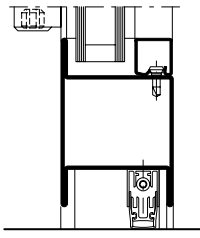
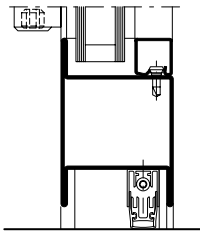
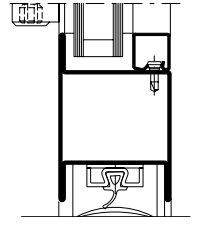
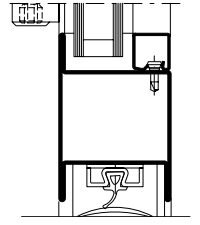
Variante	Beschlag Ferrure Fitting	 EN 12207	 EN 12208	 EN 12210		
Anschlagdichtung Joint de butée Rebate gasket 	Beschlag Ferrure Fitting 	1	0	0	C1	
		2	0	0	0	C1
		3	1	0	0	C2
Doppel-Anschlagdichtung Joint de base double Double rebate gasket 	Beschlag Ferrure Fitting 	1	1	0	C1	
		2	1	0	0	C1
		3	2	0	0	C2
Senkdichtung Joint seuil Drop seal 	Beschlag Ferrure Fitting 	1	0	0	C1	
		2	0	0	0	C1
		3	1	0	0	C2
Aufaufdichtung Joint de contact Ramp seal 	Beschlag Ferrure Fitting 	1	0	0	C1	
		2	0	0	0	C1
		3	1	0	0	C2

1 Fallenriegel-Schloss
 Serrure à mortaiser
 Latch and bolt lock





2 Schloss mit Obenverriegelung
 Serrure avec verrouillage supérieur
 Lock with top locking point

3 Mehrfachverriegelungs-Schloss
 Serrure à verrouillage multiple
 Multipoint lock

Zweiflügelige Türen,
 einwärts öffnend,
 Flügelhöhe ≤ 3000 mm

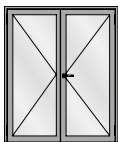
Porte à deux vantaux,
 ouvrant vers l'intérieur,
 hauteur du vantail ≤ 3000 mm

Double leaf door,
 inward opening,
 leaf height ≤ 3000 mm

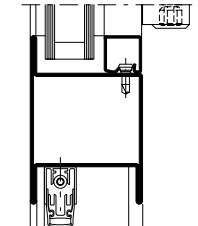
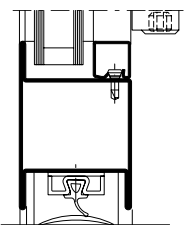
Variante		Beschlag Ferrure Fitting	 EN 12207	 EN 12208	 EN 12210
Senkdichtung Joint seuil Drop seal		1	0	0	C1
		2	0	0	C1
		3	1	0	C2
Auflaufdichtung Joint de contact Ramp seal		1	0	0	C1
		2	0	0	C1
		3	1	0	C2

U_f-Werte
(nach EN ISO 10077-2:2018-01)

Valeurs U_f
(selon EN ISO 10077-2:2018-01)

U_f values
(according to
EN ISO 10077-2:2018-01)

Auf den folgenden Seiten
finden Sie die U_f-Werte für die
verschiedenen Anwendungen von
Jansen-Economy 60 RS.

Vous trouverez les valeurs U_f
pour les différentes applications
Jansen-Economy 60 RS. dans les
pages qui suivent.

On the following pages you
will find the U_f values for the
various applications for
Jansen-Economy 60 RS.

Sie basieren auf folgenden
Grundlagen:

Elles se basent sur les principes
suivants:

They are based on the following:

Stahl

- Profile bandverzinkter Stahl,
unbeschichtet
- Stahl-Glasleisten
- Trockenverglasung
- Nassverglasung

Acier

- Profilés en bande d'acier zingué,
sans revêtement
- Parcloses en acier
- Vitrage à sec
- Vitrage à mastic



Steel

- Strip galvanised steel profiles,
uncoated
- Steel glazing beads
- Glazing with dry glazing
- Glazing with sealing

U_f-Werte
 (nach EN ISO 10077-2:2018-01)

Valeurs U_f
 (selon EN ISO 10077-2:2018-01)

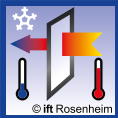
U_f values
 (according to EN ISO 10077-2:2018-01)

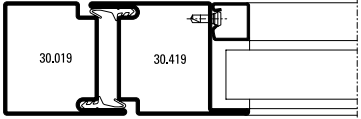
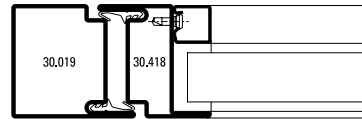
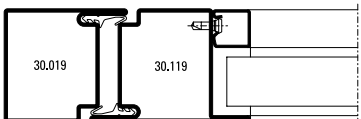
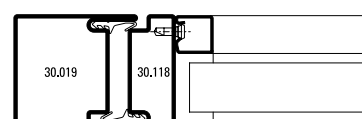
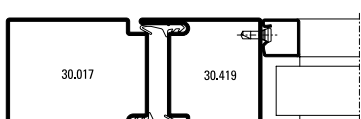
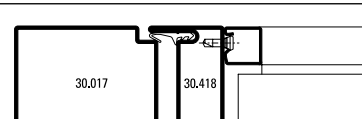
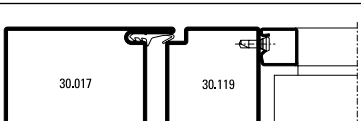
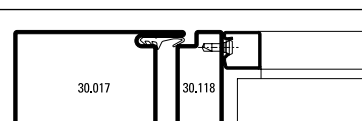
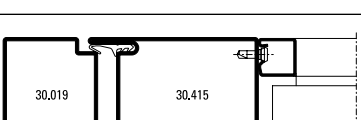
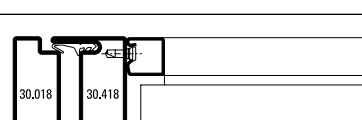
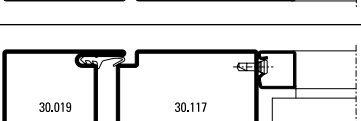
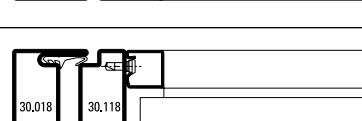
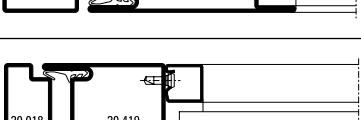
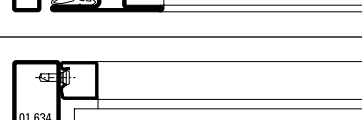
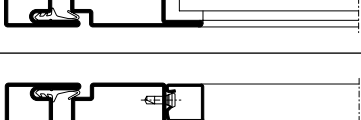
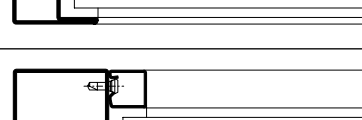
 Füllelementstärken Elements de remplissages Infill elements ≥ 24 mm		 Füllelementstärken Elements de remplissages Infill elements ≥ 24 mm	
	5,5 W/m ² K		5,7 W/m ² K
	5,6 W/m ² K		5,8 W/m ² K
	5,3 W/m ² K		5,5 W/m ² K
	5,3 W/m ² K		5,5 W/m ² K
	5,3 W/m ² K		6,0 W/m ² K
	5,3 W/m ² K		6,1 W/m ² K
	5,6 W/m ² K		6,9 W/m ² K
	5,7 W/m ² K		6,1 W/m ² K

U_f-Werte
 (nach EN ISO 10077-2:2018-01)

Valeurs U_f
 (selon EN ISO 10077-2:2018-01)

U_f values
 (according to EN ISO 10077-2:2018-01)

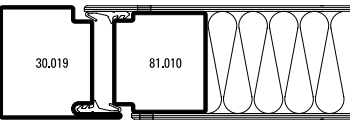
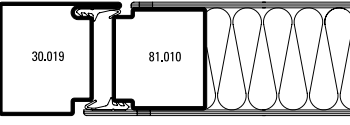
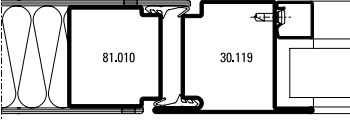
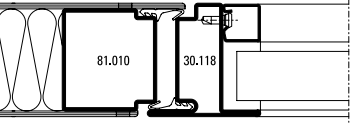
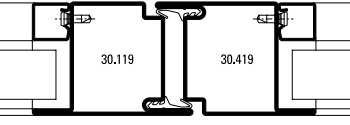
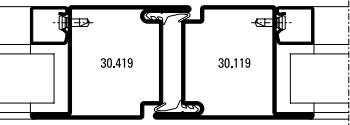
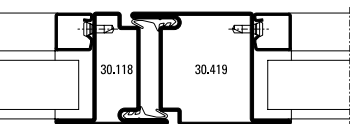
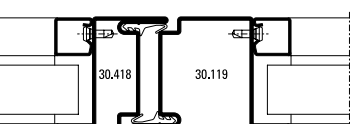

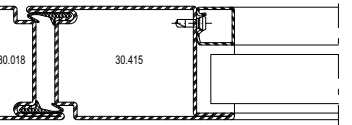
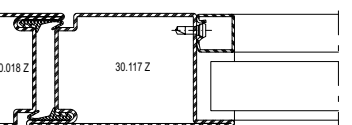
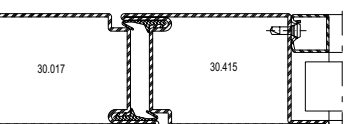
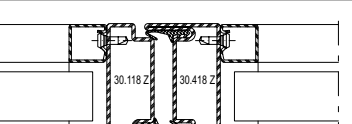
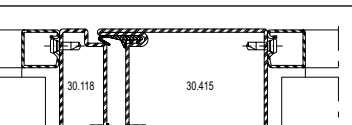
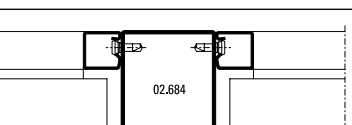
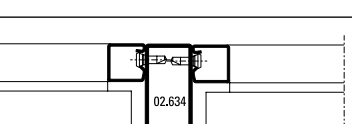
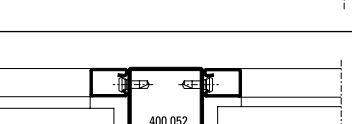
 Füllelementstärken Elements de remplissages Infill elements	$\geq 24 \text{ mm}$
	5,3 W/m ² K
	5,3 W/m ² K
	5,7 W/m ² K
	6,0 W/m ² K
	5,8 W/m ² K
	5,8 W/m ² K
	6,1 W/m ² K
	6,1 W/m ² K

 Füllelementstärken Elements de remplissages Infill elements	$\geq 24 \text{ mm}$
	5,3 W/m ² K
	5,4 W/m ² K
	5,1 W/m ² K
	6,5 W/m ² K
	5,7 W/m ² K
	6,3 W/m ² K
	7,2 W/m ² K
	6,4 W/m ² K



U_f-Werte
 (nach EN ISO 10077-2:2018-01)

Valeurs U_f
 (selon EN ISO 10077-2:2018-01)

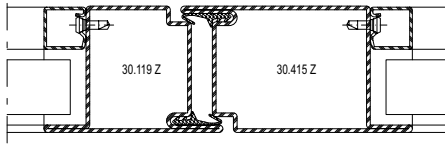
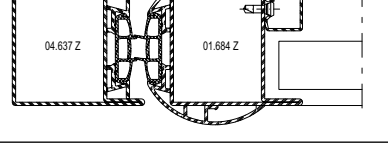
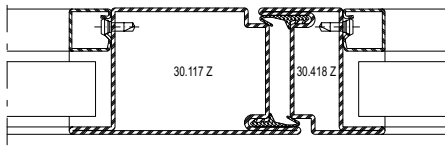
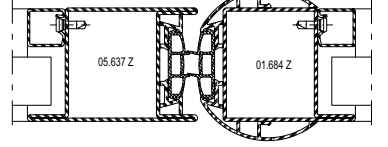
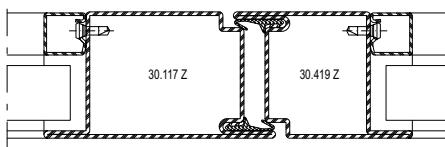
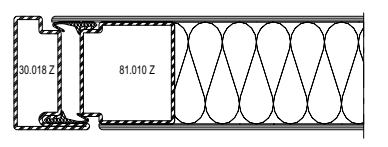
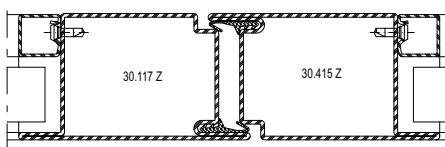
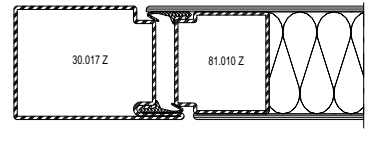
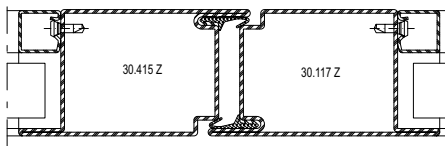
U_f values
 (according to EN ISO 10077-2:2018-01)

	Füllelementstärken Elements de remplissages Infill elements ≥ 24 mm		Füllelementstärken Elements de remplissages Infill elements ≥ 24 mm
	5,5 W/m²K		5,8 W/m²K
	5,7 W/m²K		6,0 W/m²K
	5,5 W/m²K		5,4 W/m²K
	5,3 W/m²K		5,1 W/m²K
	5,3 W/m²K		

U_f-Werte
 (nach EN ISO 10077-2:2018-01)

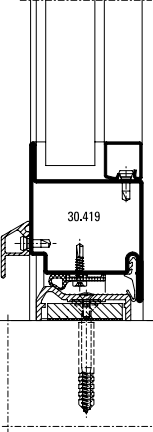
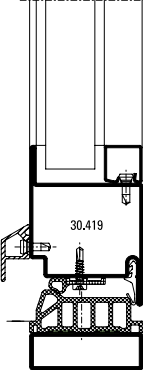
 <p>Füllelementstärken Elements de remplissages Infill elements</p> <p>≥ 24 mm</p>	
 <p>01.684</p>	<p>6,1 W/m²K</p>
 <p>30.419</p>	<p>6,3 W/m²K</p>
 <p>30.419</p>	<p>5,6 W/m²K</p>

Valeurs U_f
 (selon EN ISO 10077-2:2018-01)

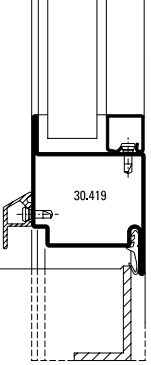
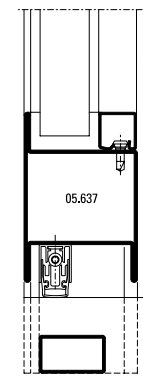
 <p>Füllelementstärken Elements de remplissages Infill elements</p> <p>≥ 24 mm</p>	
 <p>30.419</p>	<p>6,3 W/m²K</p>
 <p>05.637</p>	<p>5,6 W/m²K</p>

U_f values
 (according to EN ISO 10077-2:2018-01)

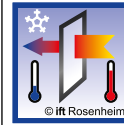
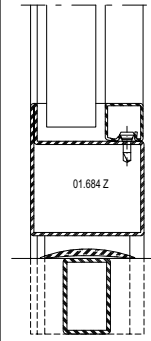
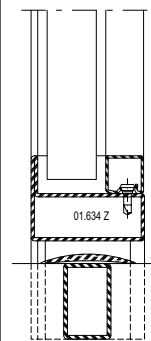
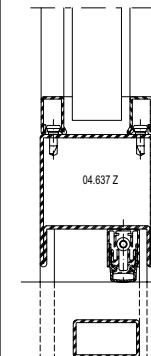
 <p>Füllelementstärken Elements de remplissages Infill elements</p> <p>≥ 24 mm</p>	
 <p>01.684 Z</p>	<p>6,1 W/m²K</p>
 <p>01.634 Z</p>	<p>6,8 W/m²K</p>
 <p>04.637 Z</p>	<p>5,5 W/m²K</p>

U_f-Werte
 (nach EN ISO 10077-2:2018-01)

Valeurs U_f
 (selon EN ISO 10077-2:2018-01)

U_f values
 (according to EN ISO 10077-2:2018-01)

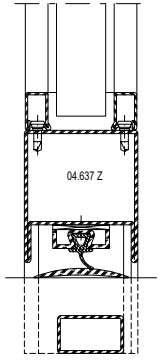
 Füllelementstärken Elements de remplissages Infill elements ≥ 24 mm	
	5,6 W/m²K

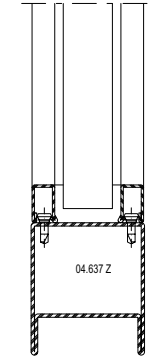
 Füllelementstärken Elements de remplissages Infill elements ≥ 24 mm	
	5,6 W/m²K

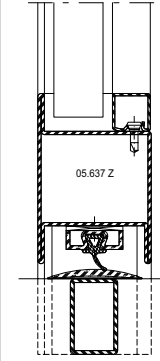
 Füllelementstärken Elements de remplissages Infill elements ≥ 24 mm	
	5,7 W/m²K

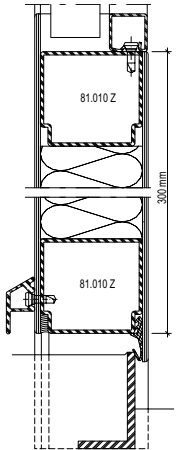
	4,4 W/m²K
--	------------------

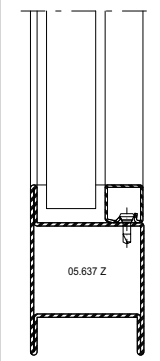
	5,7 W/m²K
--	------------------

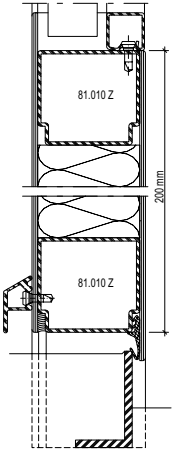
	5,2 W/m²K
---	------------------



Schallschutz

Ausführungsvarianten

Die nachfolgende Typenübersicht ergibt einen Überblick über die beurteilten Varianten.

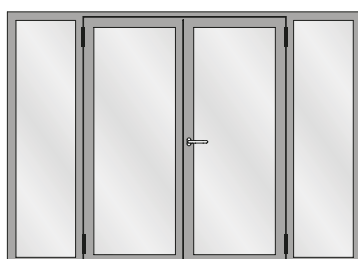
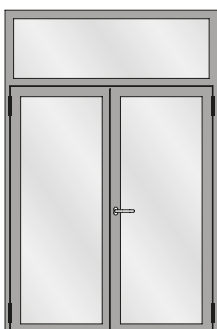
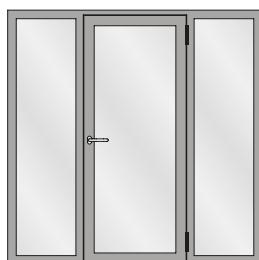
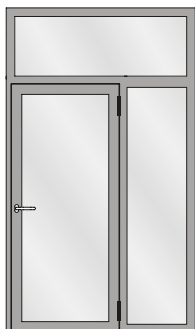
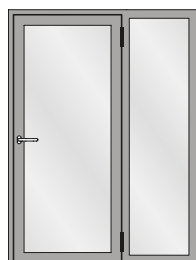
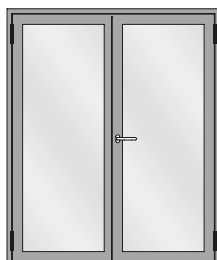
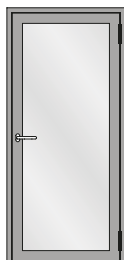

Isolation phonique

Modèles

L'aperçu des types suivant fournit une vue d'ensemble des variantes examinées.

Sound insulation

Design range

The following overview of types provides an overview of the evaluated designs.

Schallschutz

Isolation phonique

Sound insulation

Tabelle A1

Korrekturtabelle für Jansen-Economy-Türen mit Glasfüllungen

Tableau A1

Tableau de correction pour les portes Jansen-Economy avec vitrage

Table A1

Correction table for Jansen-Economy doors with glass

	1	2	3	4	5	6	7	8	9	10	11
	Türe mit zwei absenkba- ren Bodendichtungen Porte avec deux joint seuil automatique Door with two threshold gaskets that can be lowered	Glas Verre Glass	Korrekturen Corrections Corrections								
	$R_{w(C, Ctr)}$ dB	$R_{w, P, Glas}$ dB	K_S dB	K_{FV} dB	K_{Nass} dB	K_{1aB} dB	$K_{W/S}$ dB	$K_{G 0,4}$ dB	$K_{G 1,8}$ dB	$K_{G 2,6}$ dB	$K_{G 3,2}$ dB
1	32 (-1; -5)	31	0	-1	0	0	0	0	-1	-2	-3
2	33 (-1; -5)	32	0	-1	0	0	0	0	-1	-2	-3
3	35 (-1; -5)	34	0	-1	0	0	0	0	-1	-2	-3
4	36 (-2; -5)	35	0	-1	-1	0	0	0	-1	-2	-3
5	37 (-2; -5)	37	0	0	-1	0	-1	0	-1	-2	-3
6	38 (-2; -5)	39	0	0	-1	-1	-1	0	-1	-2	-3
7	39 (-2; -5)	40	0	0	-1	-1	-1	0	-1	-2	-3
8	40 (-2; -5)	41	0	0	-1	-1	-2	-1	-1	-2	-3
9	41 (-2; -5)	42	0	0	-1	-1	-2	-2	-1	-2	-3
10	42 (-2; -5)	43	-1	0	-1	-1	-2	-2	-1	-2	-3
11	42 (-2; -5)	44	-1	0	-1	-1	-2	-2	-1	-2	-3
12	43 (-2; -5)	45	-1	+1	-1	-1	-3	-3	-1	-2	-3
13	44 (-2; -5)	49	-1	+1	-1	-2	-3	-3	-1	-2	-3

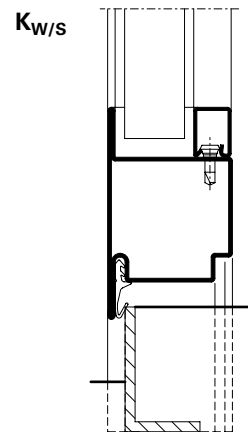
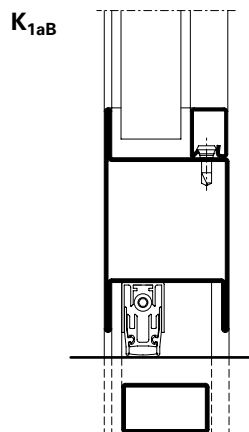
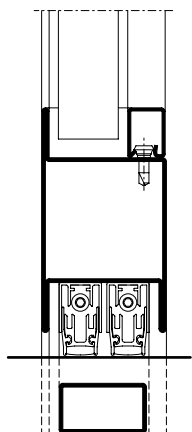

Schallschutz

Der aus der Tabelle A1 abzulesende Wert für die Schalldämmung $R_{w, Tür}$ beträgt:

Isolation phonique

La valeur à relever sur le tableau A1 concernant l'isolement contre les sons aériens $R_{w, Porte}$ est la suivante:

Sound insulation

The value taken from table A1 for the sound insulation $R_{w, Door}$ is:

$$R_{w, Tür} = R_w + K_S + K_{FV} + K_{Nass} + K_{1aB} + K_{W/S} + K_{Band} + K_{G 0,4} + K_{G 1,8} + K_{G 2,6} + K_{G 3,2} \text{ dB}$$

- R_w** bewertetes Schalldämm-Mass der Türe in Abhängigkeit von der Schalldämmung $R_{w,P, Glas}$
- $R_{w,P, Glas}$** bewertetes Schalldämm-Mass der Verglasung (Prüfwert nach ISO 140-3, mit Prüfnachweis einer PÜZ-Stelle). Alternativ können Tabellenwerte nach DIN EN 12758, Abschnitt 6 verwendet werden
- K_S** Korrekturwert für zweiflügelige Türen
- K_{FV}** Korrekturwert für Festverglasungen mit erhöhtem Scheibenanteil
- K_{Nass}** Korrekturwert für Nassverglasung
- K_{1aB}** Korrekturwert für Türen mit einer absenkbaren Bodendichtung
- K_{Band}** Korrekturwert bei Verwendung von Anschlagbändern, die eine Dichtungsebene unterbrechen ($K_{Band} = - 0,5 \text{ dB pro Band}$)
- $K_{W/S}$** Korrekturwert für Türen mit einer Anschlagsschwelle
- $K_{G 0,4}$** Korrekturwert für Einzelscheiben mit einer Glasfläche $\leq 0,4 \text{ m}^2$. Die Korrektur gilt auch für Konstruktionen mit glasteilenden Sprossen.
- $K_{G 1,8}$** Korrekturwert für Einzelscheiben mit einer Glasfläche $\geq 1,8 \text{ m}^2$
- $K_{G 2,6}$** Korrekturwert für Einzelscheiben mit einer Glasfläche $\geq 2,6 \text{ m}^2$
- $K_{G 3,2}$** Korrekturwert für Einzelscheiben mit einer Glasfläche $\geq 3,2 \text{ m}^2$

- R_w** Mesure d'isolement contre les sons aériens des portes évaluée suivant l'isolement phonique $R_{w,P, Glas}$
- $R_{w,P, Glas}$** Cote d'isolement acoustique du vitrage évalué (valeur contrôlée selon ISO 140-3 avec certificat d'un bureau de contrôle, de surveillance ou de certification). Il est également possible d'utiliser les valeurs selon le tableau DIN EN 12758, section 6
- K_S** Valeur de correction pour portes à deux vantaux
- K_{FV}** Valeur de correction pour vitrages fixes à fort pourcentage de vitre
- K_{Nass}** Valeur de correction pour vitrage avec mastic
- K_{1aB}** Valeur de correction pour portes avec un joint seuil automatique
- K_{Band}** Valeur corrective en cas d'utilisation de paumelles qui interrompent un plan d'étanchéité ($K_{Band} = - 0,5 \text{ dB par paumelle}$)
- $K_{W/S}$** Valeur de correction pour portes avec un seuil de butée
- $K_{G 0,4}$** Valeur de correction pour vitres individuelles avec une surface vitrée $\leq 0,4 \text{ m}^2$. La correction s'applique aussi aux constructions à meneaux séparant les vitres.
- $K_{G 1,8}$** Valeur de correction pour vitres individuelles avec surface vitrée $\geq 1,8 \text{ m}^2$
- $K_{G 2,6}$** Valeur de correction pour vitres individuelles avec surface vitrée $\geq 2,6 \text{ m}^2$
- $K_{G 3,2}$** Valeur de correction pour vitres individuelles avec surface vitrée $\geq 3,2 \text{ m}^2$

- R_w** Airborne sound reduction index of doors depending on the sound insulation $R_{w,P, Glas}$
- $R_{w,P, Glas}$** Airborne sound reduction index (test value in accordance with ISO 140-3, with a test certificate from a recognised testing, inspection or certification body). Alternatively, the tabulated values in DIN EN 12758, Section 6 may be used
- K_S** Correction value for double-leaf doors
- K_{FV}** Correction value for fixed glazing with increased proportion of pane
- K_{Nass}** Correction value for glazing with sealing
- K_{1aB}** Correction value for doors with a threshold gasket that can be lowered
- K_{Band}** Correction value when using hinges that interrupt a sealing plane ($K_{Band} = - 0.5 \text{ dB per hinge}$)
- $K_{W/S}$** Correction value for doors with a rebate threshold
- $K_{G 0,4}$** Correction value for single panes with a glass area $\leq 0,4 \text{ m}^2$. The correction also applies to buildings with glazing bars
- $K_{G 1,8}$** Correction value for single panes with a glass area $\geq 1,8 \text{ m}^2$
- $K_{G 2,6}$** Correction value for single panes with a glass area $\geq 2,6 \text{ m}^2$
- $K_{G 3,2}$** Correction value for single panes with a glass area $\geq 3,2 \text{ m}^2$

METALFORM

Jansen-Economy 60 RS (Smoke)

Rauchschutztüren nach EN 1634-3 und EN 16034 aus Stahl

Jansen-Economy 60 RS (Smoke)

Portes coupe-fumée selon EN 1634-3 et EN 16034 en acier

Jansen-Economy 60 RS (Smoke)

Smoke control doors according to EN 1634-3 and EN 16034 in steel

Grafische Planungsdaten wie z.B. Anwendungsbeispiele, Konstruktionsdetails, Anschlüsse am Bau, die in unseren physischen oder elektronischen Dokumentationsunterlagen enthalten sind, sind schematische Darstellungen. Gleiches gilt für digitale Medien wie CAD Dateien oder BIM Modelle.

Sie sollen den ausführenden Metallbauer und/oder Fachplaner bei der Planung und Ausführung eines Projektes unterstützen. Sie sind im konkreten Anwendungsfall durch den ausführenden Metallbauer und/oder Fachplaner auf die Verwendbarkeit im konkreten betroffenen Projekt hinsichtlich rechtlichen/regulatorischen aber auch technischen objektspezifischen Anforderungen zu überprüfen und ggfs. eigenverantwortlich anzupassen.

Bei der Überprüfung, der spezifischen Planung und der Umsetzung sind die objektspezifischen Rahmenbedingungen (Material der Bausubstanz, Dimension des Einbauelements, Farbe, Exposition, Lasteinwirkung, etc.) sowie der geltende Stand der Technik einschliesslich aller anwendbaren Normen und technischen Richtlinien eigenverantwortlich zu beachten.

Falls das vorliegende Dokument Differenzen zur aktuellen deutschen Version (Artikel Nr. K1214227) aufweist, gilt in jedem Fall der deutsche Originaltext in der jeweils geltenden Fassung im Jansen Docu Center.

Alle Ausführungen dieser Dokumentation haben wir sorgfältig und nach bestem Wissen zusammengestellt. Wir können aber keine Verantwortung für die Benutzung der vermittelten Vorschläge und Daten übernehmen. Wir behalten uns technische Änderungen ohne Vorankündigung vor.

Les données de planification graphiques, comme les exemples d'application, détails de construction et raccordements au bâtiment, fournies dans notre documentation physique et numérique sont des représentations schématiques. Il en va de même pour les médias numériques comme les fichiers CAD ou modèles BIM.

Leur but est de faciliter la planification et réalisation d'un projet par les constructeurs métalliques et/ou concepteurs. Concrètement, elles doivent être vérifiées par le constructeur métallique et/ou le concepteur et, le cas échéant, modifiées de son propre chef pour s'assurer qu'elles concordent avec le projet concerné et qu'elles répondent aux exigences techniques spécifiques ainsi qu'aux dispositions légales et réglementaires.

Lors de la vérification, de la planification spécifique et de la mise en œuvre, il y a lieu de tenir compte des conditions spécifiques à l'objet (matériaux du bâtiment, dimension de l'élément d'insert, couleur, exposition, effet de charge, etc.) ainsi que de l'état actuel de la technique, y compris toutes les normes et directives techniques applicables.

En cas de divergence entre le présent document et la version allemande (no d'article K1214227), c'est dans tous les cas le texte original allemand qui prévaut dans sa version actuelle disponible dans le Jansen Docu Center.

Nous avons apporté le plus grand soin à l'élaboration de cette documentation. Cependant, nous déclinons toute responsabilité pour l'utilisation faite de nos propositions et de nos données.

Nous nous réservons le droit de procéder à des modifications techniques sans préavis.

Graphical planning data such as application examples, construction details, connections on site that are contained in our physical or electronic documentation components are schematic representations. The same applies to digital media such as CAD files or BIM models.

They are intended to support the metal worker and/or design engineer in planning and executing projects. In the specific case of application they are to be checked by the metal worker and/or design engineer in terms of their usability in the specific project concerned with regard to legal/regulatory and technical property-specific requirements and adjusted if necessary at the latter's own responsibility.

The property-specific underlying conditions (construction material, dimensions of installation element, colour, exposure, load effect etc.) and current state of the art including all applicable norms and technical guidelines are to be taken into consideration at the metal worker and/or design engineer's own responsibility during the review, specific planning and implementation.

If there are any differences between this document and the current German version (item number K1214227), the latest version of the original German text in the Jansen Docu Center shall prevail.

All the information contained in this documentation is given to the best of our knowledge and ability. However, we decline all responsibility for the use made of these suggestions and data.

We reserve the right to effect technical modifications without prior warning.

Inhaltsverzeichnis		Jansen-Economy 60 RS	
Sommaire		Jansen-Economy 60 RS	
Content		Jansen-Economy 60 RS	

Systemübersicht	Sommaire du système	Summary of system	2
Merkmale Zulassungen Systemausführungen Typenübersicht	Caractéristiques Homologations Exécutions de système Sommaire des types	Characteristics Authorisations System versions Summary of types	

Profilsortiment	Assortiment de profilé	Range of profiles	12
------------------------	-------------------------------	--------------------------	-----------

Beispiele	Exemples	Examples	16
Schnittpunkte Konstruktionsdetails Anschlüsse am Bau	Coupes de détails Détails de construction Raccords au mur	Section details Construction details Attachment to structure	

Leistungseigenschaften	Caractéristiques de performance	Performance characteristics	28
-------------------------------	--	------------------------------------	-----------







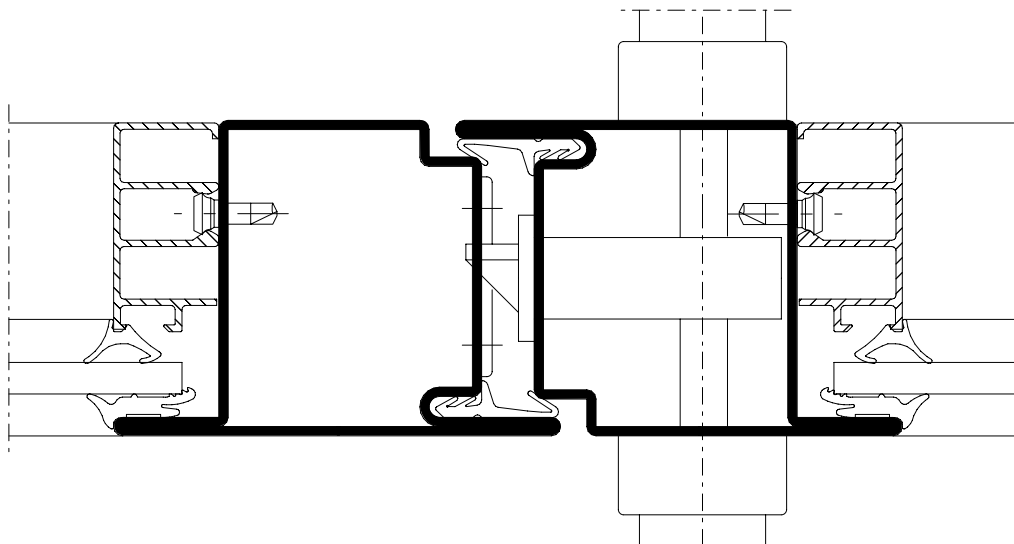

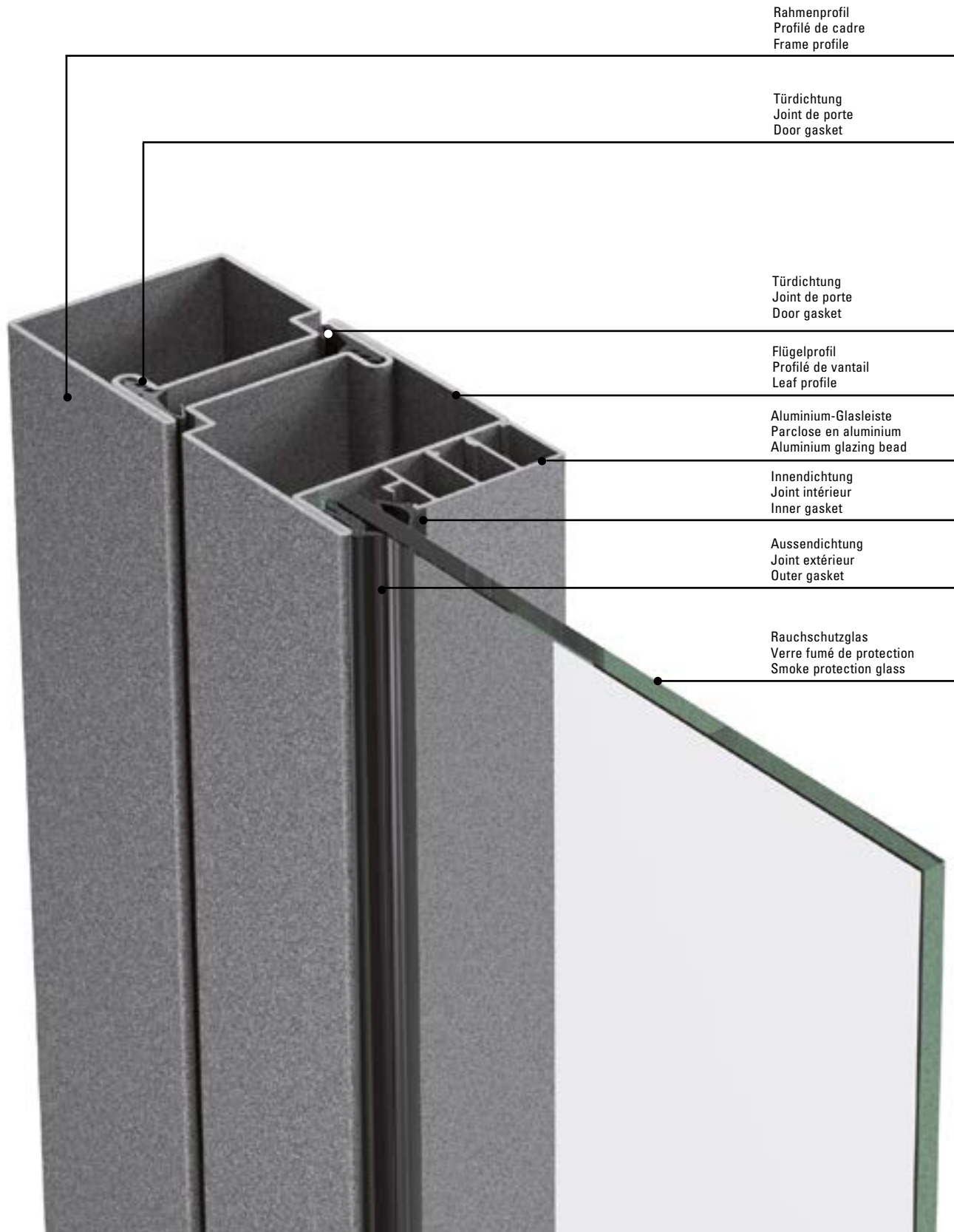

Merkmale
Caractéristiques
Characteristics





Jansen-Economy 60 RS
Jansen-Economy 60 RS
Jansen-Economy 60 RS

- Stahlssystem für Türen und Festverglasungen
 - Bautiefe 60 mm, innen und aussen flächenbündig
 - Schmale Ansichtsbreiten: Rahmen und Flügel ab 105 mm Stulppartie 150 mm
 - Ein- und zweiflüglige Türen, nach innen und aussen öffnend, mit oder ohne Seitenteile und Oberlichter sowie Trennwände
 - Türflügel bis 1750 x 3750 mm (BxH), landesspezifische Zulassung beachten
 - Füllelementstärke von 5 bis 26 mm, Glaseinbau mittels Trocken- oder Nassverglasung
 - Stahlprofile blank oder bandverzinkt
 - Grosses Sortiment an systemgeprüften Türbeschlägen
 - Barrierefreie Schwellenausbildungen
 - Geeignet für Pulver- und Nasslackbeschichtungen
 - Rauchschutztüre gemäss EN 1634-3 und EN 16034, Systemprüfungen nach Produktnorm EN 14351-1
 - Erscheinungsbild deckungsgleich mit anderen Jansen Brandschutzsystemen Jansen-Economy 50, Janisol 2 und Janisol C4
- Système en acier pour portes et vitrages fixes
 - Profondeur de montage 60 mm, montage à fleur à l'intérieur et à l'extérieur
 - Fines largeurs de face: Cadre et vantaux à partir de 105 mm Partie tête 150 mm
 - Portes à un et deux vantaux, ouverture vers l'intérieur et vers l'extérieur, combinables avec parties latérales, impostes et vitrage fixe
 - Vantaux de porte jusqu'à 1750 x 3750 mm (LaxH), il convient de respecter les prescriptions et règlements des divers pays concernés
 - Élément de remplissage de 5 à 26 mm d'épaisseur, Montage du vitrage à sec ou à silicone
 - Profilés en acier brut ou galvanisé en continu
 - Grand assortiment de ferrures de porte homologuées
 - Formes de seuil sans barrière
 - Convient aux revêtements par poudre ou peinture liquide
 - Porte coupe-fumée selon EN 1634-3 et EN 16034, contrôles des systèmes selon la norme produit EN 14351-1
 - Apparence égale comme les autres systèmes coupe-feu de Jansen (Jansen-Economy 50, Janisol 2 et Janisol C4)
- Steel system for doors and fixed glazing
 - 60 mm basic depth, flush-fitted on the inside and outside
 - Narrow face widths: Frame and leaf from 105 mm Meeting stile assembly 150 mm
 - Single and double-leaf doors, inward and outward-opening, can be combined with side-lights, toplight or fixed glazing
 - Door leaf up to 1750 x 3750 mm (WxH), the regulations and bye-laws in force in the particular country must be respected
 - Infill unit thickness of 5 to 26 mm, Glazing installed by means of dry or wet glazing
 - Raw finish or strip galvanised steel profiles
 - Large range of system-tested door fittings
 - Easy-access thresholds
 - Suitable for powder and wet paint coating
 - Smoke-proof door according to EN 1634-3 and EN 16034, system tests in accordance with EN 14351-1
 - Same appearance as the other Jansen fire-resistant systems Jansen-Economy 50, Janisol 2 and Janisol C4





Norm	Eigenschaft Caractéristique Characteristic	Klassifizierung/Wert Classification / Valeur Classification / Value										
		npd	1 (400)	2 (800)	3 (1200)	4 (1600)	5 (2000)	Exxx (>2000)				
 EN 12210	Widerstandsfähigkeit bei Windlast Résistance à la pression du vent Resistance to wind load	npd	1 (400)	2 (800)	3 (1200)	4 (1600)	5 (2000)	Exxx (>2000)				
 EN 12208	Schlagregendichtheit Etanchéité à la pluie battante Watertightness	npd	1A (0)	2A (50)	3A (100)	4A (150)	5A (200)	6A (250)	7A (300)	8A (450)	9A (600)	Exxx (>750)
 EN ISO 10140	Schalldämmung R_w (C, C_{tr}) (dB) Isolation phonique R_w (C, C_{tr}) (dB) Sound insulation R_w (C, C_{tr}) (dB)	npd	bis R_w 44 dB (-2; -5) jusqu'à R_w 44 dB (-2; -5) up to R_w 44 dB (-2; -5)									
 EN ISO 10077-2	Wärmedurchgangskoeffizient U_f (W/(m ² ·K)) Transmission thermique U_f (W/(m ² ·K)) Thermal production U_f (W/(m ² ·K))	npd	ab 5.65 W/m ² K à partir de 5.65 W/m ² K from 5.65 W/m ² K									
 EN 12207	Luftdurchlässigkeit Perméabilité à l'air Air permeability	npd	1 (150)		2 (300)		3 (600)		4 (600)			
 EN 1192	Klassifizierung der Festigkeitsanforderungen Classification des exigences de résistance méc. Classification of strength requirements	npd	1		2		3		4			
 EN 1627	Einbruchhemmung Anti-effraction Burglar resistance	npd	1		2		3		4		5	6
 EN 1522	Durchschusshemmung Résistance aux balles Bullet proofing	npd	FB1	FB2	FB3	FB4	FB5	FB6	FB7	FSG		
 EN 1191 EN 1603	Dauerfunktionsprüfung Durabilité mécanique Mechanical durability		D 1 5'000	2 10'000	3 20'000	4 50'000	5 100'000	6 200'000	7 500'000	8 1'000'000		
 EN 179 EN 1125	Fähigkeit zur Freigabe Capacité au déclenchement Ability to release		Anforderung erfüllt Exigence remplie Requirement fulfilled									

Norm	Eigenschaft Caractéristique Characteristic	Klassifizierung/Wert Classification / Valeur Classification / Value			
 EN 12217	Bedienkräfte Forces de manœuvre Operating forces	npd	0	1	2
 EN 1634-3	Rauchschutz Etanchéité à la fumée Smoke control		S_a / S_{200}		
 EN 16034 EN 13501-2	Selbstschliessung Fermeture automatique Self-closing		C		
 EN 16034	Dauerhaftigkeit der Selbstschliessung gegenüber Alterung (Korrosion) Endurance de la fermeture automatique contre le vieillissement (corrosion) Durability of self-closing against ageing (corrosion)		erzielt atteinte achieved		



Fluchttürsysteme

- Fluchttürsysteme geeignet für Notausgänge und Paniktüren
- Fluchttürnorm EN 179 für Notausgangsverschlüsse erfüllt
- Fluchttürnorm EN 1125 für Panikverschlüsse erfüllt

Systèmes de porte de secours

- Systèmes de porte de secours pour issues de secours et portes panique
- Norme relative aux portes de secours EN 179, remplie pour les fermetures d'issue de secours
- Norme relative aux portes de secours EN 1125, remplie pour les fermetures panique

Emergency exit systems

- Emergency exit systems suitable for emergency exits and panic doors
- Emergency exit standard EN 179 for emergency exit devices fulfilled
- Emergency exit standard EN 1125 for panic exit devices fulfilled



Einbruchhemmende Jansen-Economy 60 RS Türen

- Türgrößen bis 1475 x 3000 mm
- Ein- und zweiflüglige Türen, nach innen und aussen öffnend
- Normal- und Panikfunktion bis RC3
- Geprüft nach EN 1627

Portes anti-effraction Jansen-Economy 60 RS

- Dimensions de porte jusqu'à 1475 x 3000 mm
- Portes à un/deux vantaux ouvrant vers l'intérieur et l'extérieur
- Fonction normale et fonction panique jusqu'à RC3
- Contrôlé selon la norme EN 1627

Burglar-resistant Jansen Economy 60 RS doors

- Door sizes up to 1475 x 3000 mm
- Single and double-leaf doors, inward and outward-opening
- Standard and panic function up to RC3
- Tested in accordance with EN 1627



Verblechte Jansen-Economy 60 RS Türen

- Für ein- und zweiflügelige Brandschutztüren mit oder ohne Seitenteile resp. Oberlichter
- Flächenbündig verblechte Türen
- Bleche können an den Rahmen geschweisst oder geklebt werden
- Mit oder ohne Glasausschnitte möglich

Portes tôlées Jansen-Economy 60 RS

- Pour des portes coupe-feu à un/deux vantaux avec ou sans pièces latérales ou impostes
- Portes tôlées à fleur
- Les tôles peuvent être soudées ou collées sur le cadre
- Possibles avec ou sans panneaux de verre

Jansen Economy 60 RS sheet metal doors

- For single and double-leaf fire doors with or without sidelights or toplights
- Flush-fitted sheet metal doors
- Sheet metal can be welded or bonded to the frame
- Possible with or without glass vision panels

Jansen Docu Center

Die Plattform zum effizienten Arbeiten mit Jansen Dokumentationen. Im Jansen Docu Center stehen alle Produktinformationen jederzeit digital in der aktuellsten Version zur Verfügung: von Architekten-Informationen über Bestell- und Fertigungskatalogen bis hin zu Anleitungen und Prospekten sowie Videos.

Die Inhalte können einfach und schnell aufgerufen werden. Ein für den Anwender komfortables papierloses Arbeiten, das zahlreiche Vorteile bietet.

Download CAD Daten

DXF

DWG

Sie können die Zeichnungen in den Formaten DXF und/oder DWG herunterladen. Klicken Sie auf das entsprechende Icon und der Download erfolgt.

Die Hinweise «Artikelbibliothek/Türbeschläge/Fensterbeschläge» bedeuten, dass Sie mit einem Klick die gesamte Artikelbibliothek des entsprechenden Systems herunterladen (Profile, Beschläge, Glasleisten, Zubehör etc.).

Info und Beratung

Gerne beraten wir Sie persönlich und stehen Ihnen bei Fragen zur Verfügung. Bitte schreiben Sie uns Ihre Anliegen an: info@jansen.com

Jansen Docu Center

La plate-forme pour travailler efficacement avec les documentations Jansen. Le Jansen Docu Center met à votre disposition les informations sur les produits, en format numérique et dans une version actualisée: des catalogues de commande et de fabrication aux instructions et prospectus, en passant par les informations destinées aux architectes et vidéos.

Les contenus sont facilement et rapidement accessibles. Une manière de travailler confortable et offrant de nombreux avantages.

Télécharger fichiers DAO

DXF

DWG

Vous pouvez télécharger les dessins aux formats DXF et/ou DWG. Cliquez sur l'icône correspondante et le téléchargement s'effectuera.

Les indications «Bibliothèque des articles/Ferures de porte/Ferrures de fenêtres» signifie que vous téléchargez la totalité de la bibliothèque des articles du système donné (profilés, ferrures, parcloles, accessoires etc.).

Info et conseils

Nous vous conseillons volontiers individuellement et sommes à votre disposition si vous avez des questions à poser. Veuillez nous envoyer votre requête à: info@jansen.com

Jansen Docu Center

The platform for working efficiently with Jansen documentation. The latest version of all the product information is available digitally at any time in the Jansen Docu Center – from order and fabrication manuals to architect information, instructions and brochures and videos.

The content can be retrieved quickly and easily. The user can work conveniently without paper, which has numerous benefits.

Download CAD files

DXF

DWG

You can download the drawings in DXF and/or DWG format. Click on the relevant icon to begin the download.

The items «Article library/Door fittings/Window fittings» means that you download the entire article library for the corresponding system with one click (profiles, fittings, glazing beads, accessories etc.).

Information and advice

We would be delighted to provide you with advice in person and are available to answer any questions you may have. Please write to us with your queries at: info@jansen.com

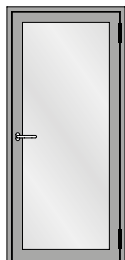

Einflügelige Türe
 Porte à un vantail
 Single leaf door

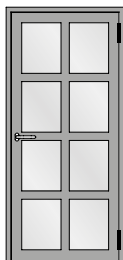

Einflügelige Türe mit Riegel
 Porte à un vantail avec traverse
 Single leaf door with transom

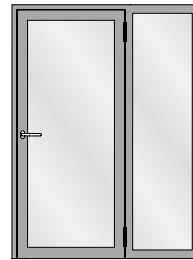

Einflügelige Türe mit festem Seitenteil
 Porte à un vantail avec partie latérale fixe
 Single leaf door with fixed side light

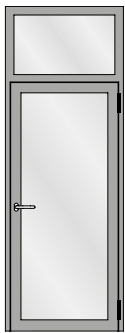

Einflügelige Türe mit festem Oberlicht
 Porte à un vantail avec imposte fixe
 Single leaf door with fixed top light

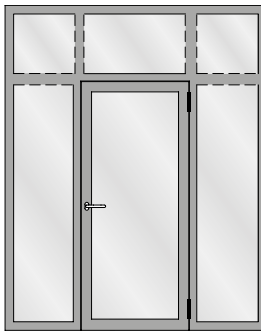

Einflügelige Türe mit zwei festen Seitenteilen
 und festem Oberlicht
 Porte à un vantail avec deux parties latérale fixe
 et imposte fixe
 Single leaf door with two fixed side light and
 fixed top light

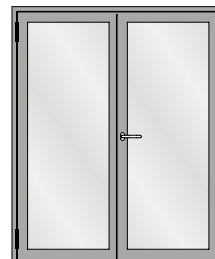

Zweiflügelige Türe
 Porte à deux vantaux
 Double leaf door



Zweiflügelige Türe mit zwei festen Seitenteilen
 Porte à deux vantaux avec deux parties
 latérales fixes
 Double leaf door with two fixed side lights

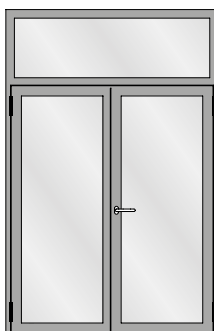

Zweiflügelige Türe mit festem Oberlicht
 Porte à deux vantaux avec imposte fixe
 Double leaf door with fixed top light

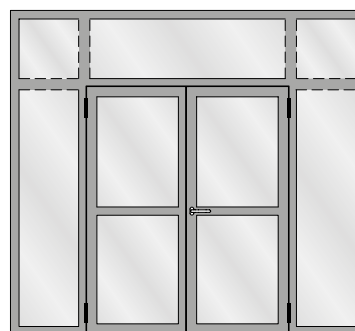

Zweiflügelige Türe mit zwei festen Seitenteilen
 und festen Oberlichtern
 Porte à deux vantaux avec deux parties latérales
 fixes et impostes fixes
 Double leaf door with two fixed side lights and
 fixed top lights

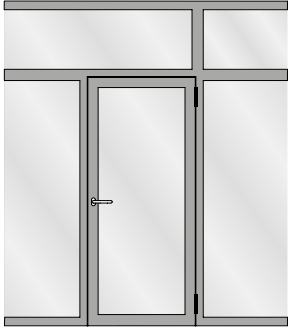

Festverglasung mit einflügeliger Türe
Vitrage fixe avec porte à un vantail
Fixed glazing with single leaf door

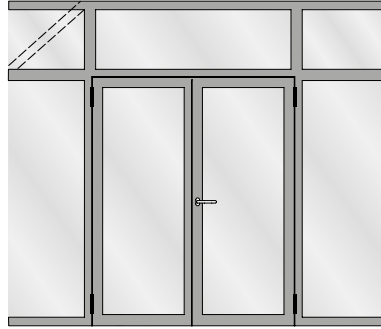

Festverglasung mit zweiflügeliger Türe
Vitrage fixe avec porte à deux vantaux
Fixed glazing with double leaf door



Festverglasung
Vitrage fixe
Fixed glazing

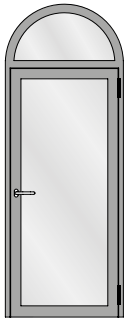

Einflügelige Türe mit Rundbogen-Oberlicht
Porte à un vantail avec imposte demi-ronde
Single leaf door with round arched top light

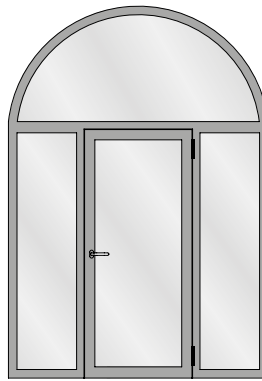

Einflügelige Türe mit zwei festen Seitenteilen
und Rundbogen-Oberlicht
Porte à un vantail avec deux parties latérales
fixes et imposte demi-ronde
Single leaf door with two fixed side lights and
round arched top light

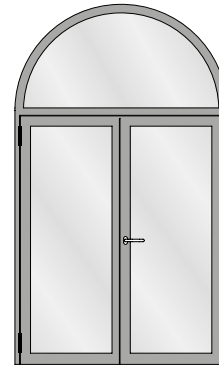

Zweiflügelige Türe mit Rundbogen-Oberlicht
Porte à deux vantaux avec imposte demi-ronde
Double leaf door with round arched top light

**Für Festverglasungen gelten
nationale Zulassungen.**

**Les homologations nationales
s'appliquent aux vitrages fixes.**

**National approvals apply to fixed
glazing.**

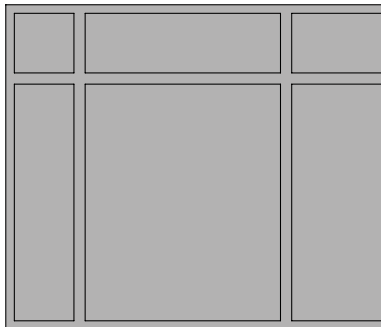
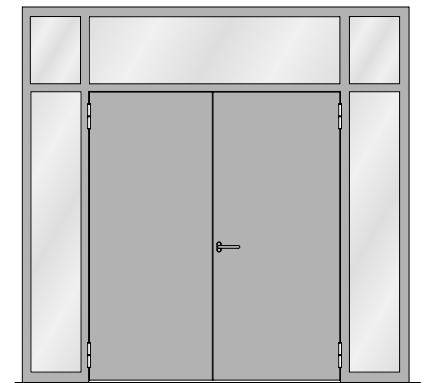
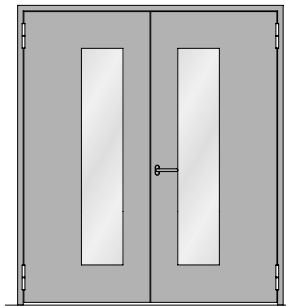
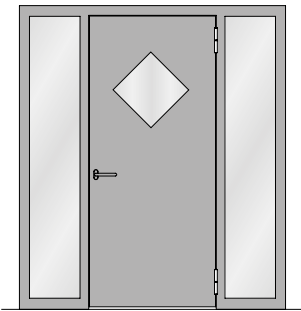
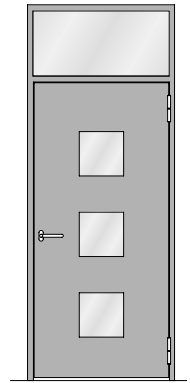
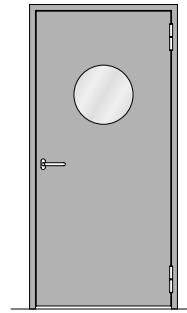
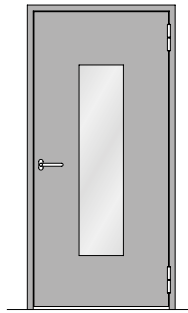
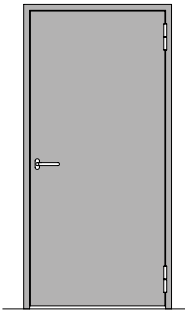

Für Festverglasungen gelten nationale Zulassungen.

Les homologations nationales s'appliquent aux vitrages fixes.

National approvals apply to fixed glazing.

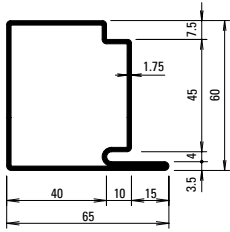

30.019
30.019 Z

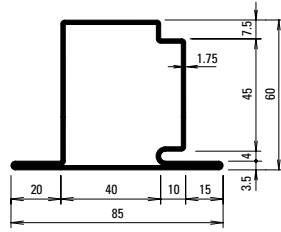

30.119
30.119 Z

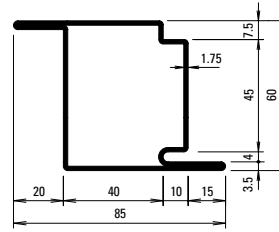

30.419
30.419 Z

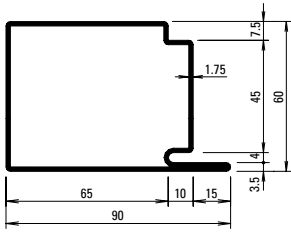

30.017
30.017 Z

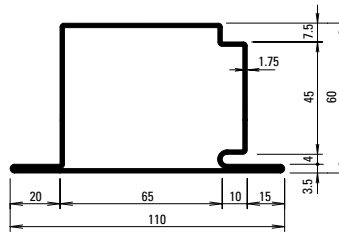

30.117
30.117 Z

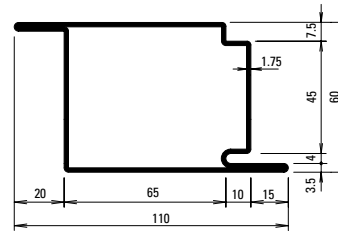

30.415

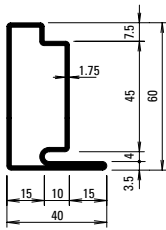

30.018
30.018 Z

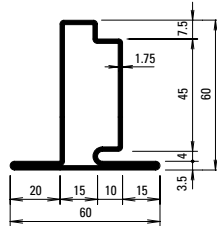

30.118
30.118 Z

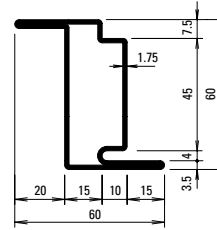

30.418
30.418 Z

Oberfläche/Werkstoff

Artikel-Nr.

ohne Zusatz = blank

mit Z = bandverzinkter Stahl

Surface/Matériau

No. d'article

sans supplément = brut

avec Z = bande d'acier zinguée

Surface/Material

Part no.

without addition = bright

with Z = strip galvanised steel

Profil-Nr.	G kg/m	F cm ²	I _x cm ⁴	W _x cm ³	I _y cm ⁴	W _y cm ³	U m ² /m
30.017	4,190	5,33	31,17	9,04	48,34	10,30	0,310
30.018	2,830	3,61	15,96	4,36	4,77	1,93	0,212
30.019	3,517	4,48	23,69	6,71	19,75	5,56	0,262
30.117	4,746	6,05	34,81	9,37	65,86	11,54	0,351
30.118	3,364	4,29	18,64	4,65	8,62	2,76	0,250
30.119	3,486	4,44	23,36	6,08	25,26	5,70	0,301

Profil-Nr.	G kg/m	F cm ²	I _x cm ⁴	W _x cm ³	I _y cm ⁴	W _y cm ³	U m ² /m
30.415	4,746	6,04	37,87	12,33	65,86	11,54	0,351
30.418	3,364	4,29	22,93	7,37	8,62	2,76	0,250
30.419	3,486	4,44	26,49	8,57	25,26	5,70	0,301

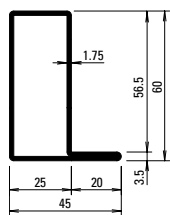

01.634
01.634 Z

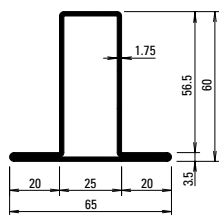

02.634
02.634 Z

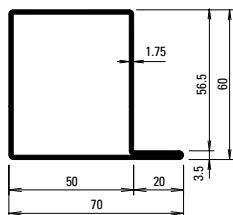

01.684
01.684 Z

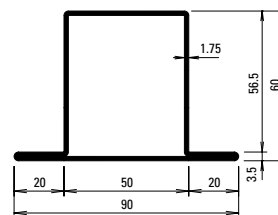

02.684
02.684 Z

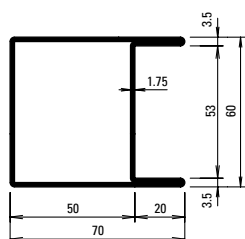

04.637
04.637 Z

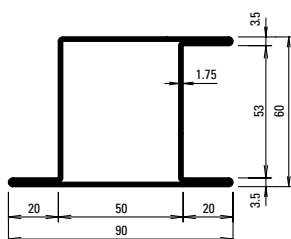

05.637
05.637 Z

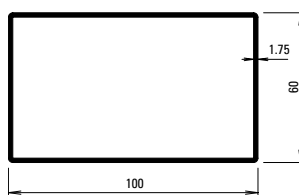

400.051
400.051 Z

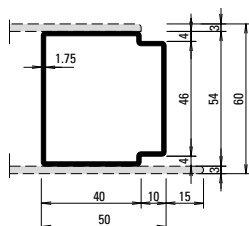

81.010 Z

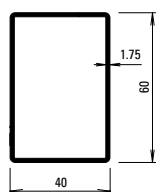

400.052
400.052 Z

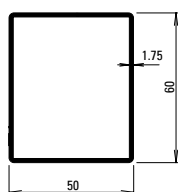

400.054
400.054 Z

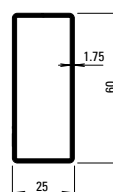

400.055
400.055 Z

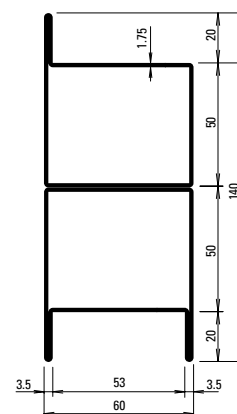

05.001

Profil-Nr.	G kg/m	F cm ²	I _x cm ⁴	W _x cm ³	I _y cm ⁴	W _y cm ³	U m ² /m
01.634	2,729	3,48	16,56	4,66	6,01	2,14	0,204
02.634	3,266	4,16	19,52	4,96	10,33	3,18	0,243
01.684	2,948	3,76	21,13	6,13	19,15	4,84	0,255
02.684	3,412	4,35	24,14	6,41	27,64	6,14	0,294
04.637	3,960	5,05	30,63	10,21	27,46	7,72	0,294
05.637	3,875	4,94	30,92	9,26	34,14	6,94	0,334
81.010	2,696	3,44	14,54	5,38	13,06	5,11	0,202
400.051	4,272	5,44	34,64	11,55	76,01	15,20	0,317
400.052	2,627	3,35	16,87	5,62	8,99	4,49	0,197
400.054	2,901	3,70	19,84	6,61	14,97	5,99	0,217
400.055	2,214	2,82	12,41	4,14	3,09	2,47	0,167

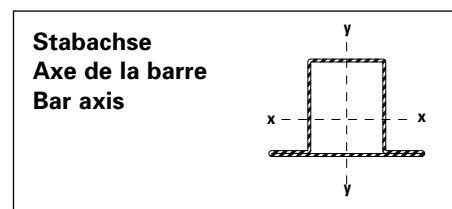

Artikelbibliothek
 Bibliothèque des articles
 Article library

DXF **DWG**

Bogentüren
Portes cintrées
Arched doors

Jansen-Economy 60 RS
 Jansen-Economy 60 RS
 Jansen-Economy 60 RS

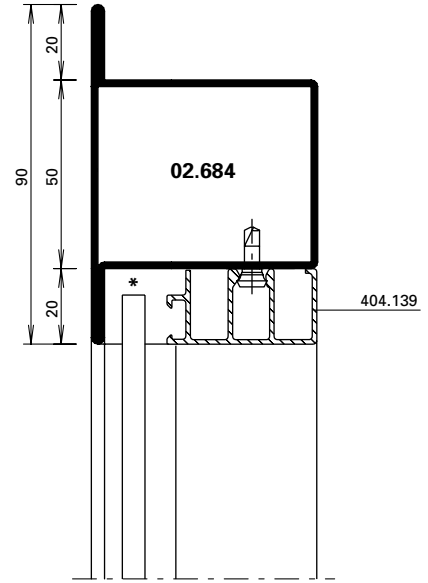
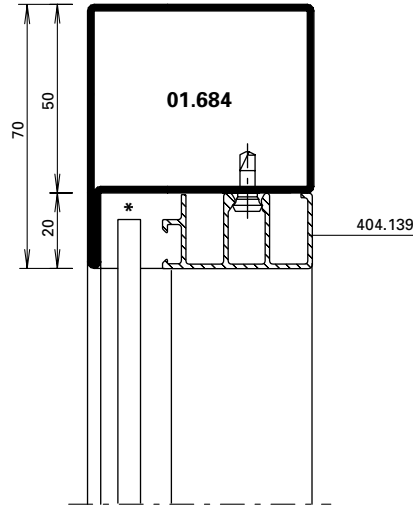
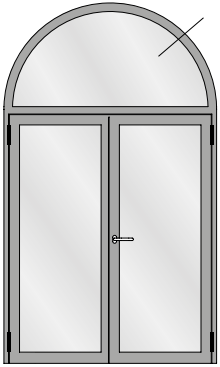

* Füllelemente mit rauchdichtem dauerelastischem Dichtstoff (z.B. 450.092) vollständig in den Glasfalzgrund einkleben.

* Coller entièrement les éléments de remplissage avec produit d'étanchéité à l'élasticité permanente (p.ex. 450.092) dans la feuillure en verre.

* Infill panels with smoke-tight, permanently flexible sealant (e.g. 450.092) fully glued into the glazing rebate platform.

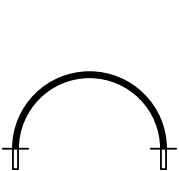

Halbrundbogen
 Arc semi-circulaire
 Semi-circular arch

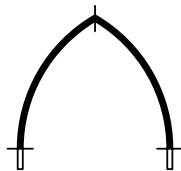

Spitzbogen
 Arc en ogive
 Gothic arch



Stichbogen
 Arc bombé
 Segmented arch



Korbbogen
 Anse de panier
 Oval arch

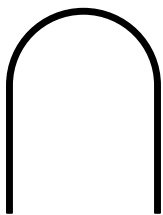

Halbrundbogen mit Schenkel
 Arc surhaussé prolongée
 Semi-circular arch with side extension

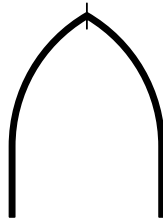

Spitzbogen mit Schenkel
 Arc en ogive prolongée
 Gothic arch with side extension

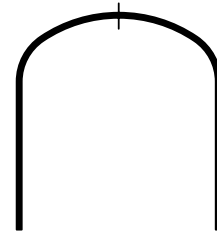



Korbbogen mit Schenkel
 Anse de panier prolongée
 Oval arch with side extension

Bogentüren
Portes cintrées
Arched doors

Jansen-Economy 60 RS
 Jansen-Economy 60 RS
 Jansen-Economy 60 RS

Profil Profilé Profile	Min. Radius Rayon min. Min. radius R	blank brut bright	verzinkt zinguée galvanised
		mm	mm
01.634	550	550	
01.684	650	650	

		mm	mm
02.634	600	650	
02.684	1050	1050	

		mm	mm
04.637	1550	1550	

		mm	mm
05.637	1550	1550	

		mm	mm
400.052	1100	1100	
400.054	1000	1000	
400.055	800	800	
81.010		800	

Profil Profilé Profile	Min. Radius Rayon min. Min. radius R	blank brut bright	verzinkt zinguée galvanised
		mm	mm
30.018		550	
30.019	650	650	

		mm	mm
30.118	800	800	
30.119	900	900	

		mm	mm
30.418	800	800	
30.419	1100	1100	

Stahl-Glasleisten Parcloses en acier Steel glazing beads	Min. Radius Rayon min. Min. radius R
--	---

		mm
62.507 Z	300	mm
62.508 Z	300	mm
62.509 Z	300	mm

Stahl-Glasleisten Parcloses en acier Steel glazing beads	Min. Radius Rayon min. Min. radius R	
		mm
402.112 Z	500	mm
402.115 Z	500	mm
402.120 Z	600	mm
402.125 Z	750	mm
402.130 Z	1000	mm
402.135 Z	1500	mm

Aluminium-Glasleisten Parcloses en aluminium Aluminium glazing beads	Min. Radius Rayon min. Min. radius R
--	---

		mm
404.109	400	mm
404.112	400	mm
404.115	400	mm
404.120	400	mm
404.125	450	mm
404.130	500	mm
404.135	600	mm

		mm
405.110	500	mm
405.115	500	mm
405.120	500	mm
405.125	800	mm
405.130	1000	mm
406.903	500	mm
406.905	500	mm
406.907	500	mm
406.909	600	mm

Die Radien-Angaben beziehen sich auf die langjährige Erfahrung und Fertigung im Hause Jansen.

Les rayons indiqués se fondent sur la longue expérience et la fabrication au sein de la maison Jansen.

The radii specifications are based on the many years of experience Jansen has in fabrication.

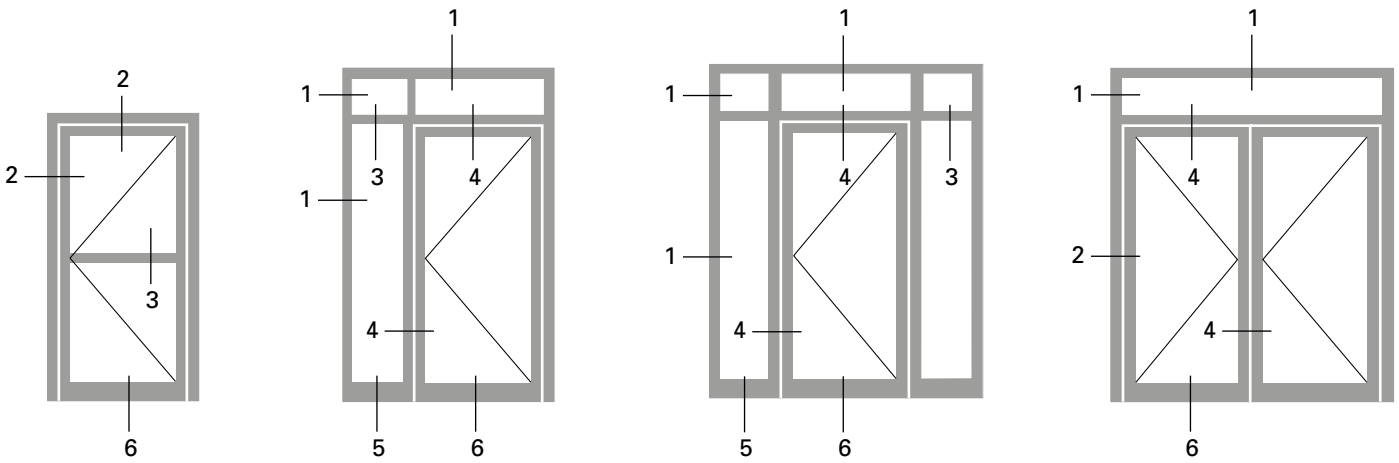

3.0

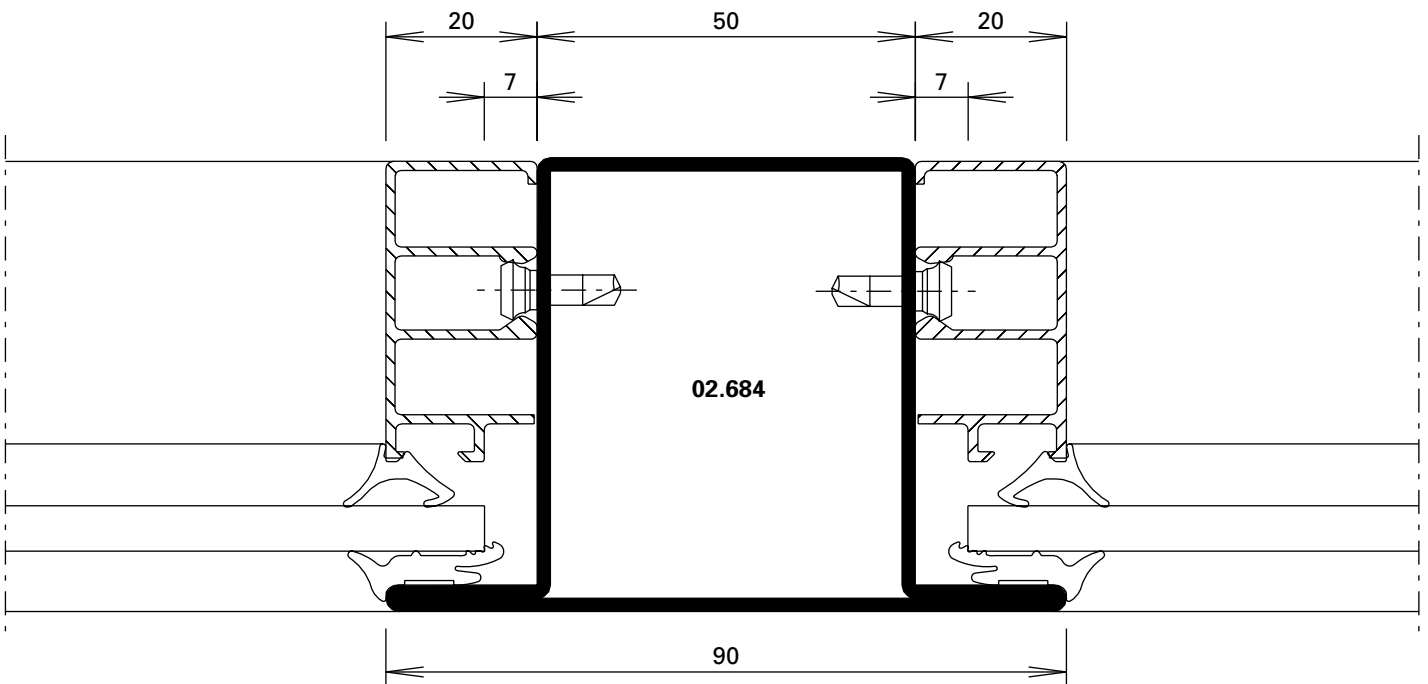

DXF DWG 41-0301-C-007

2.0

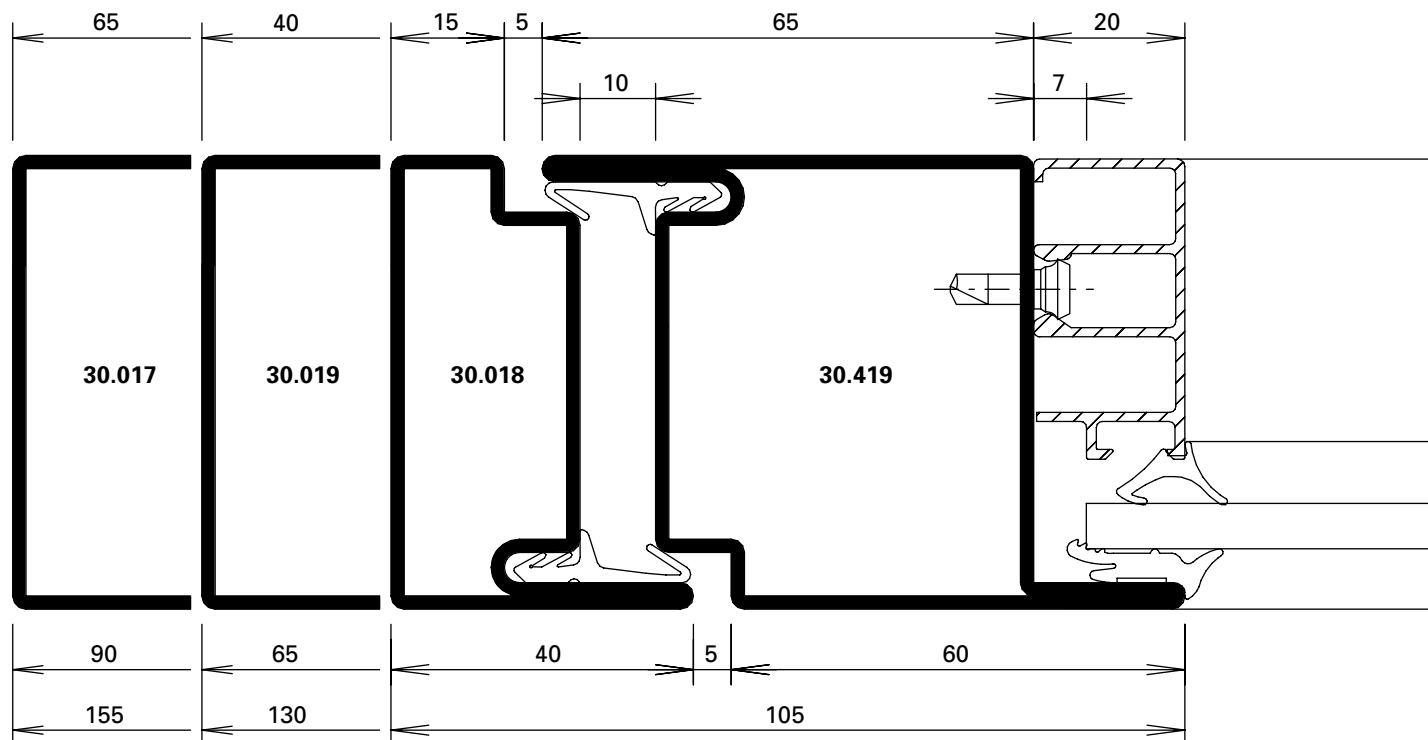

DXF **DWG** 41-0301-C-004

4.0

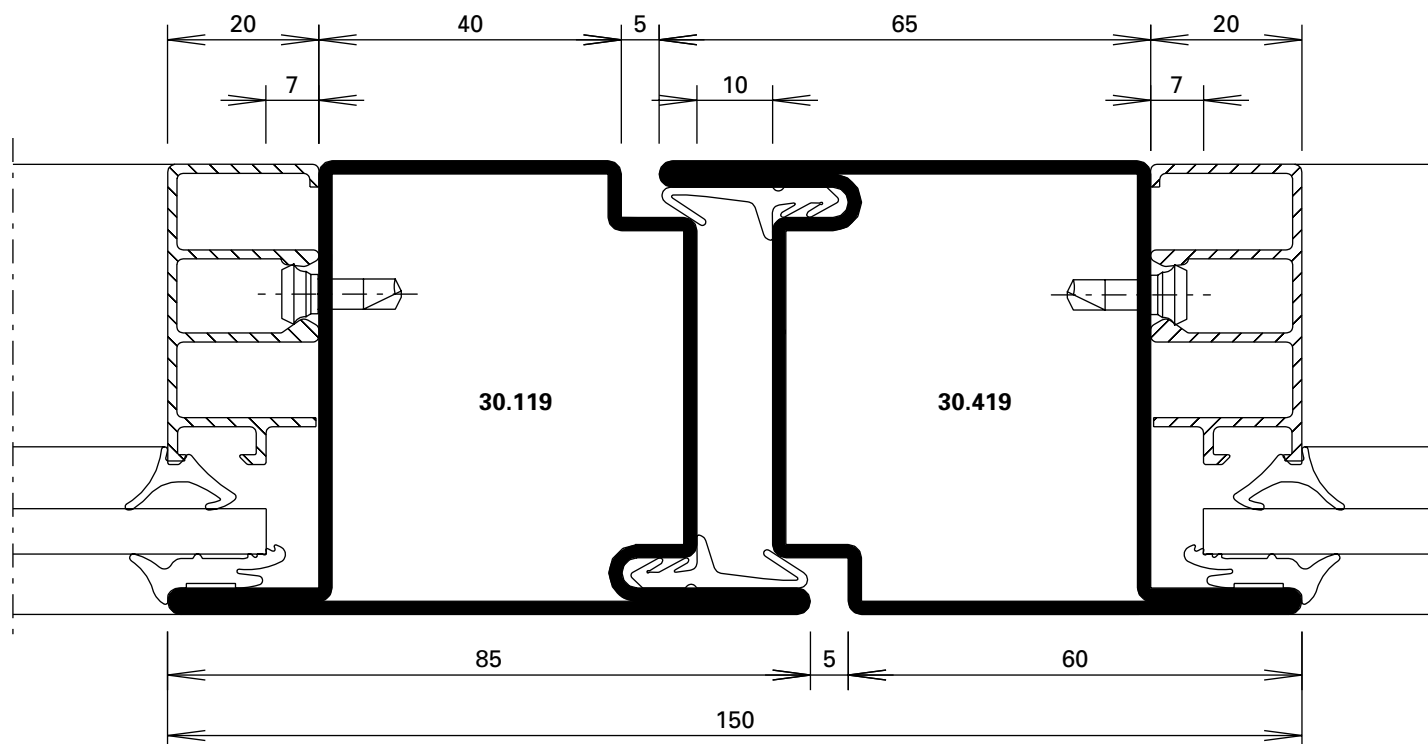

DXF **DWG** 41-0301-C-008

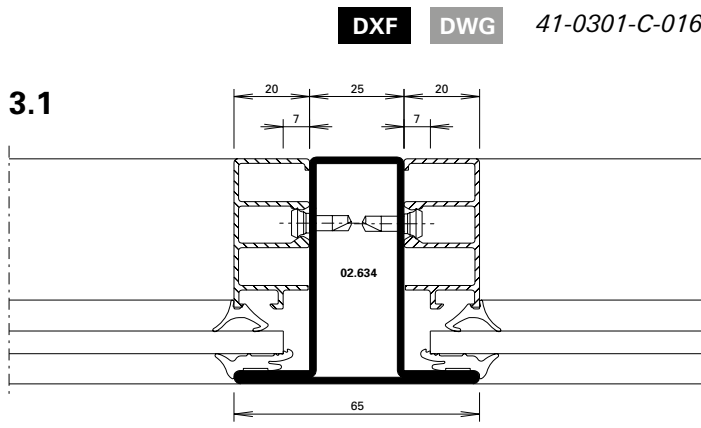
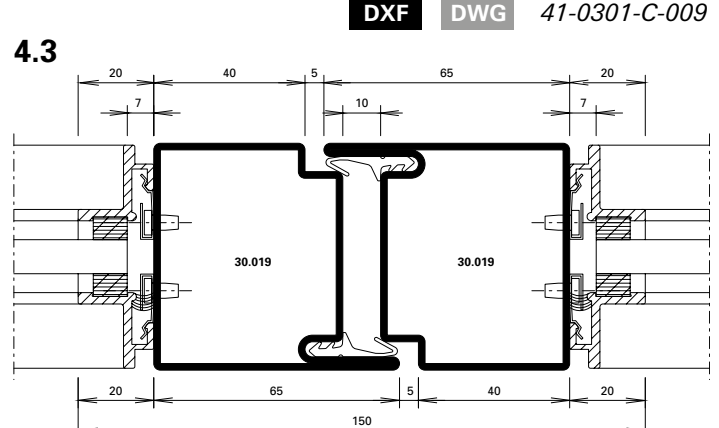
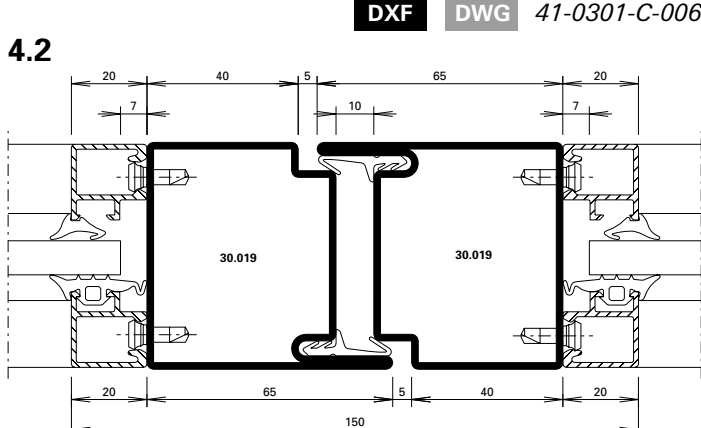
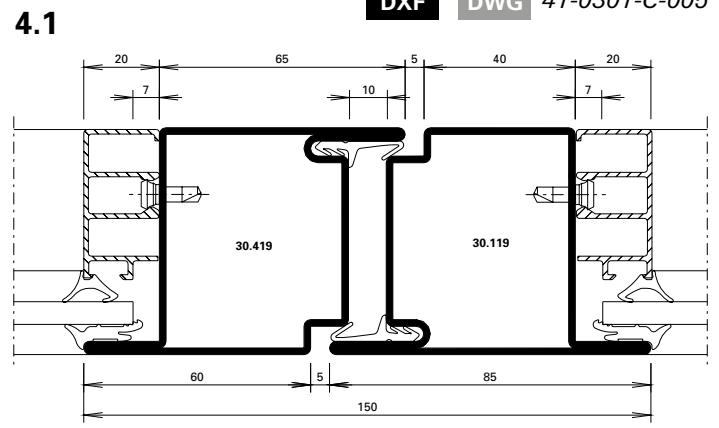
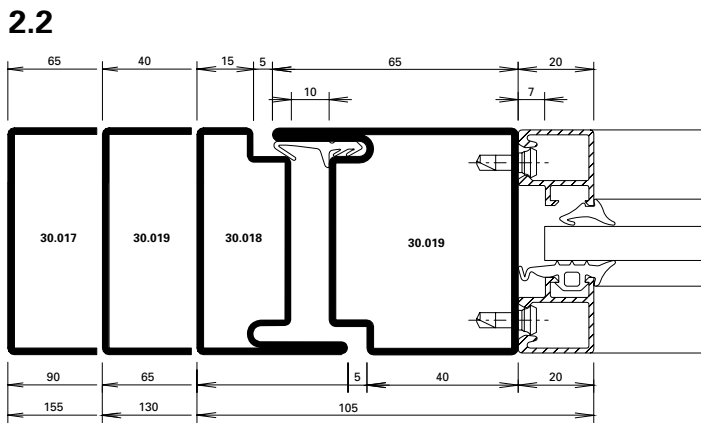
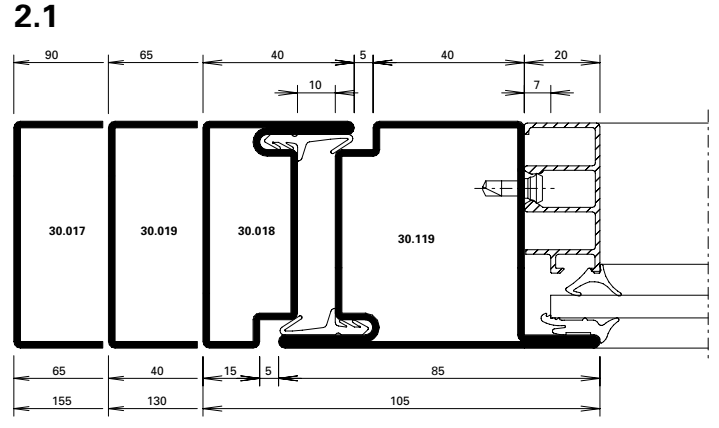
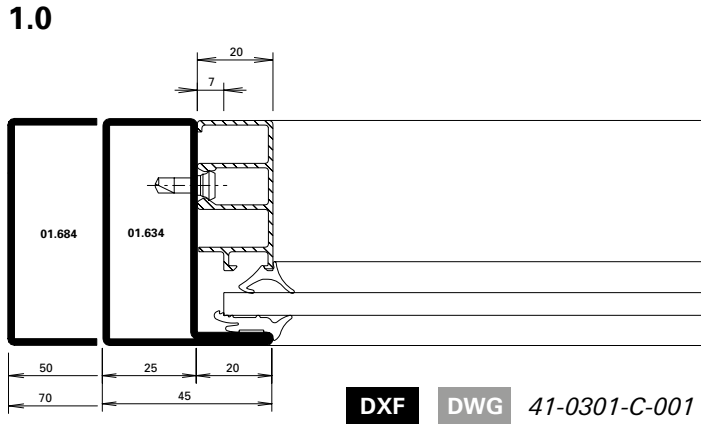

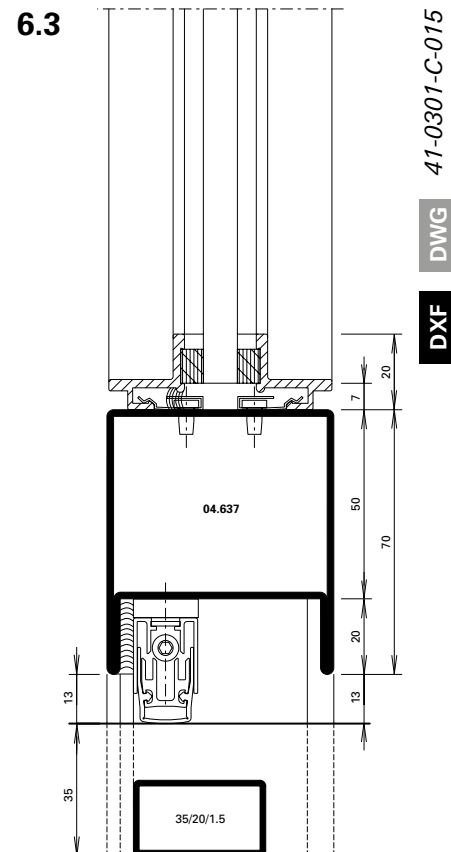
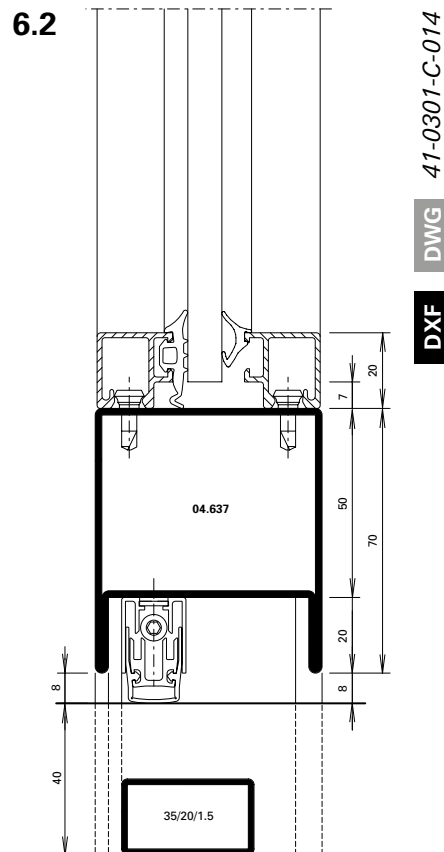
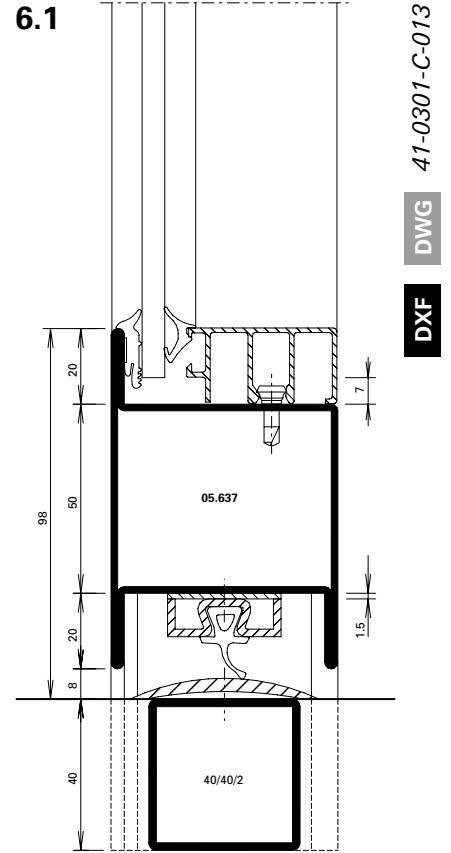
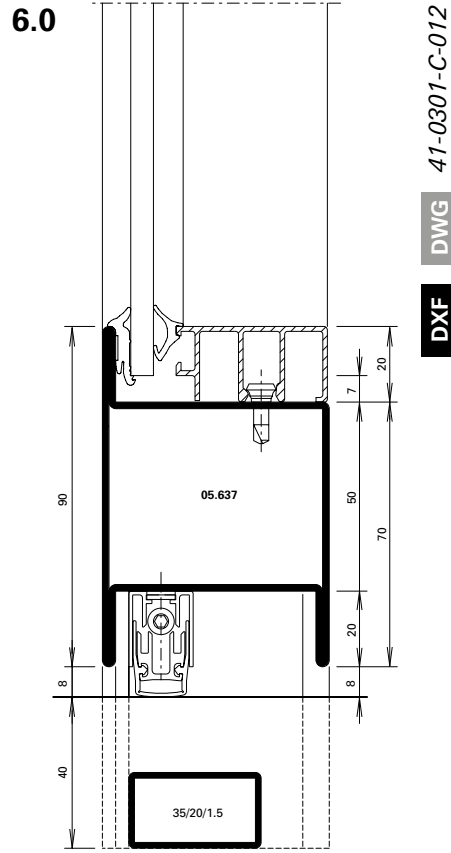
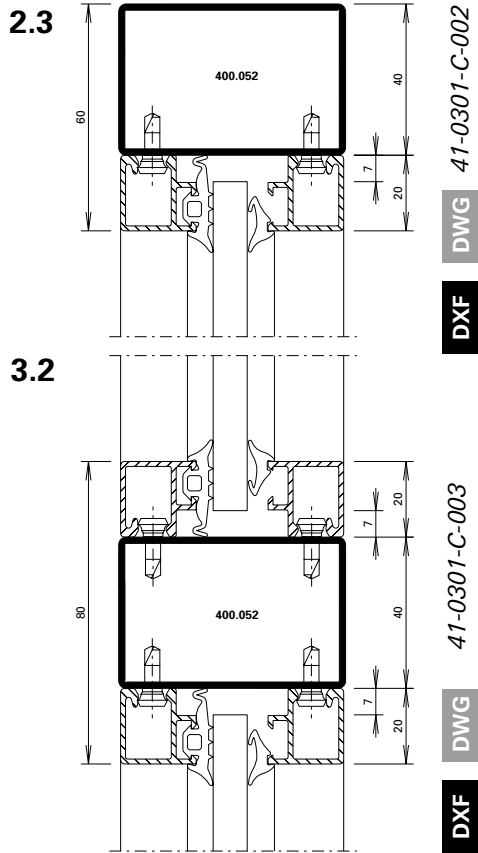

Glasleisten-Varianten im Masstab 1:2
Variantes de parcloses à l'échelle 1:2
Glazing bead options on scale 1:2

Jansen-Economy 60 RS
 Jansen-Economy 60 RS
 Jansen-Economy 60 RS

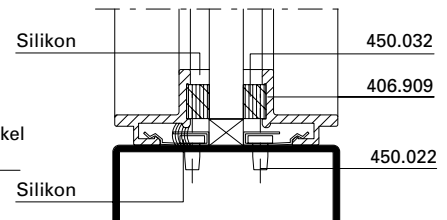
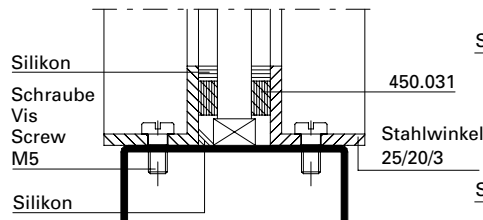
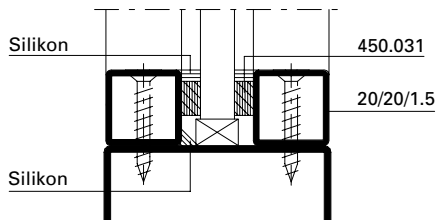
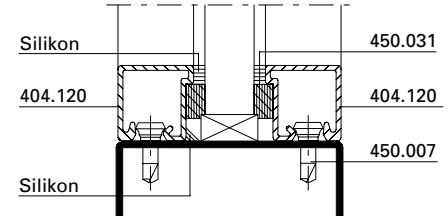
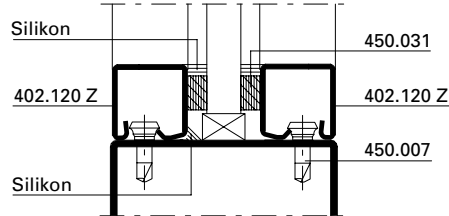
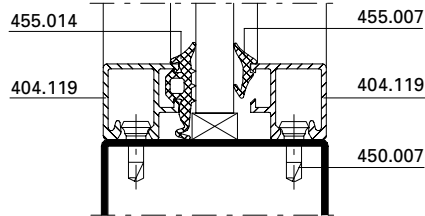
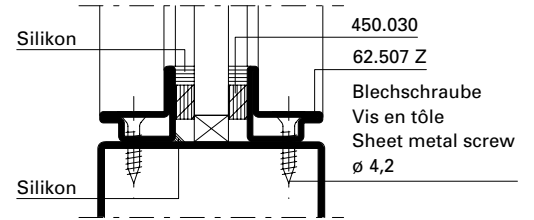
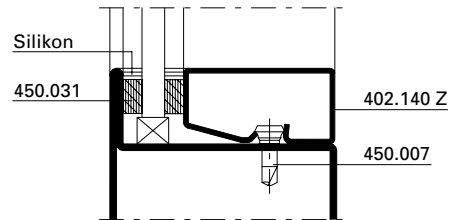
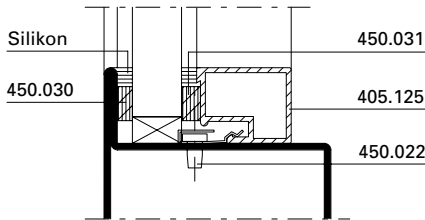
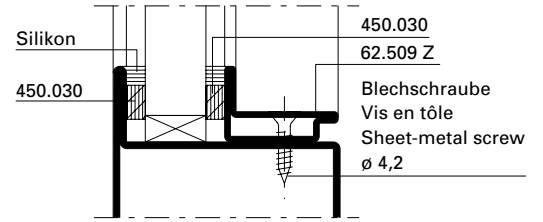
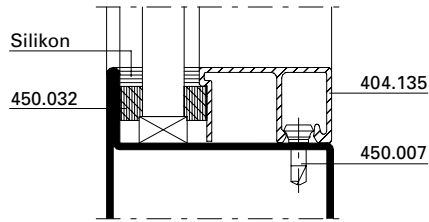
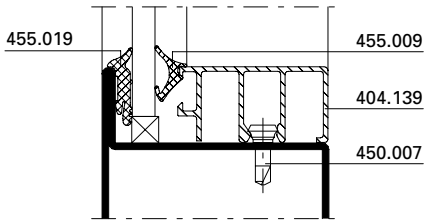

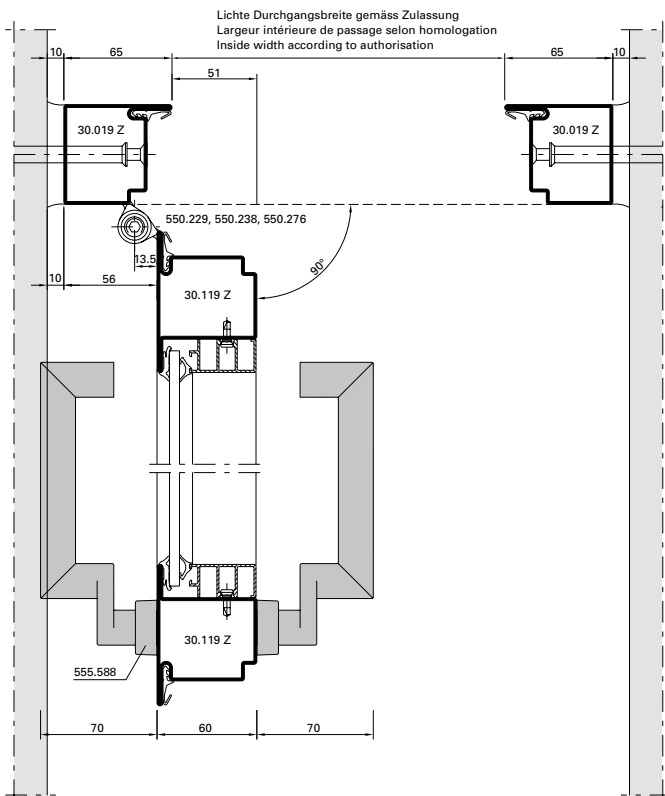

DXF **DWG** 41-0301-E-013

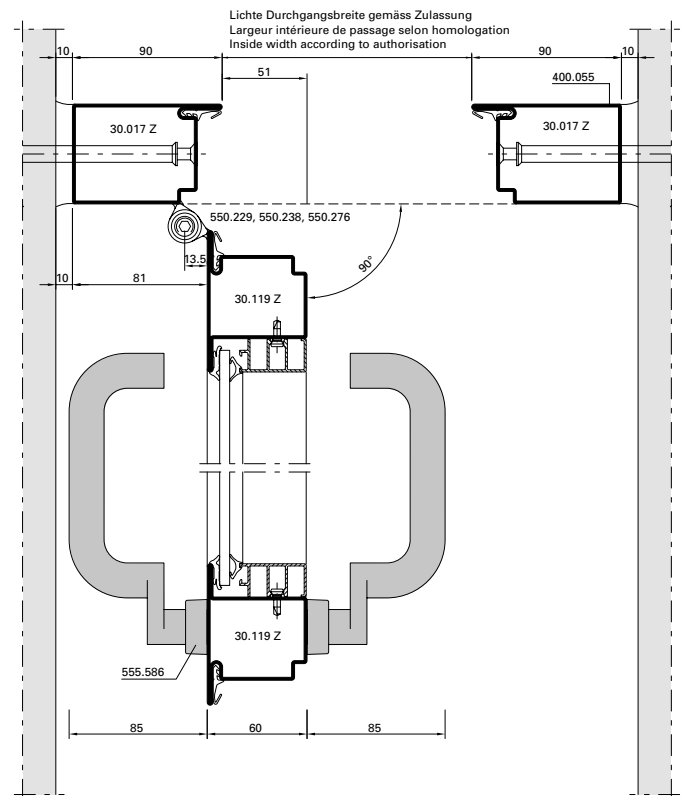

DXF **DWG** 41-0301-E-014

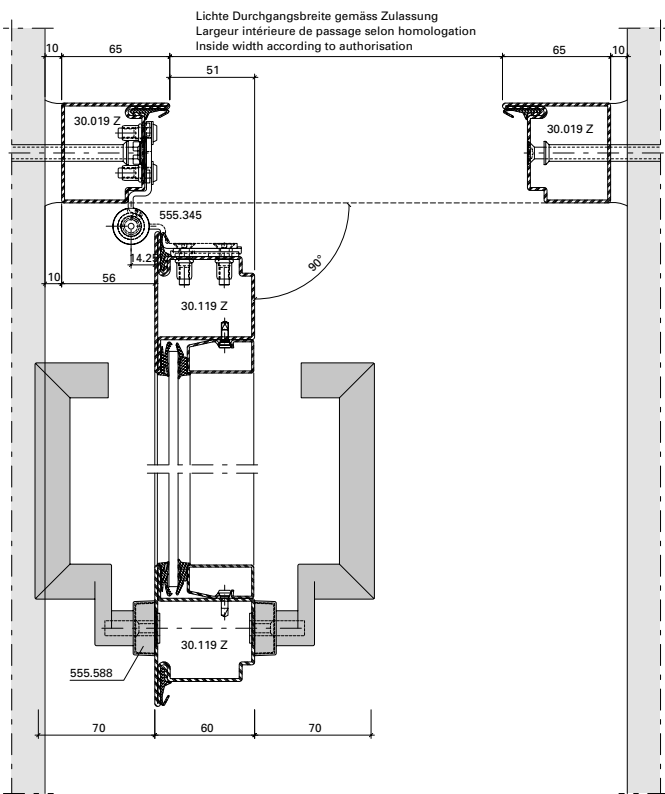

DXF **DWG** 41-0301-E-015

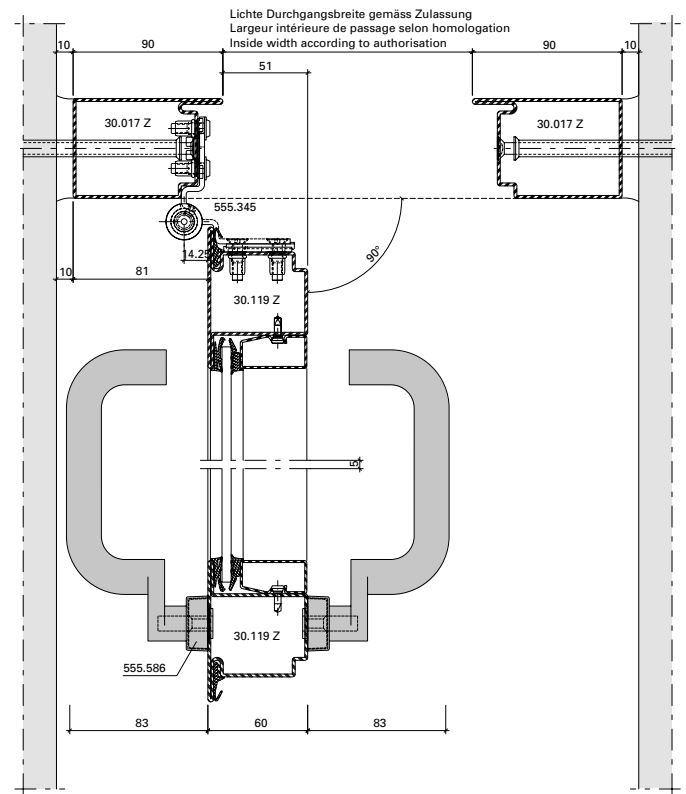

DXF **DWG** 41-0301-E-016

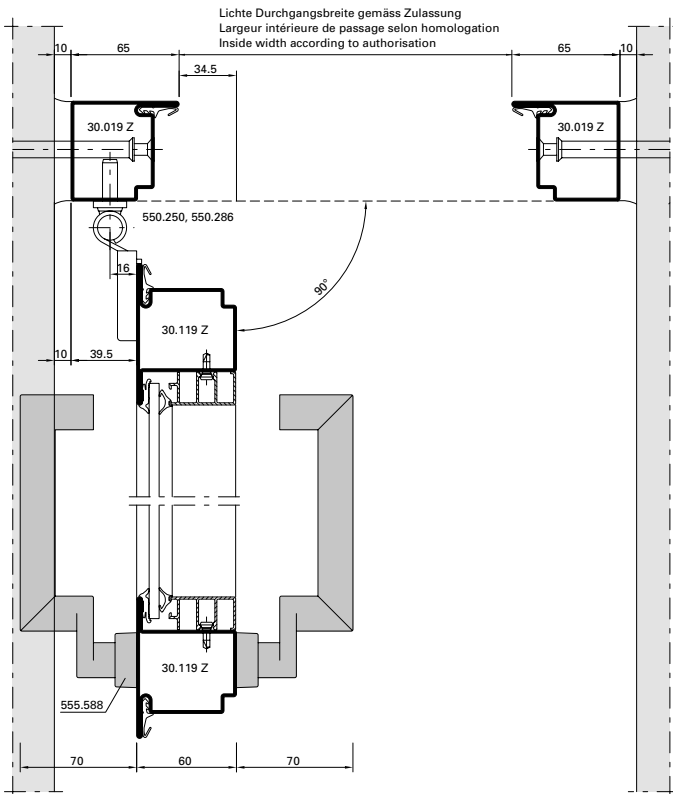

DXF **DWG** 41-0301-E-017

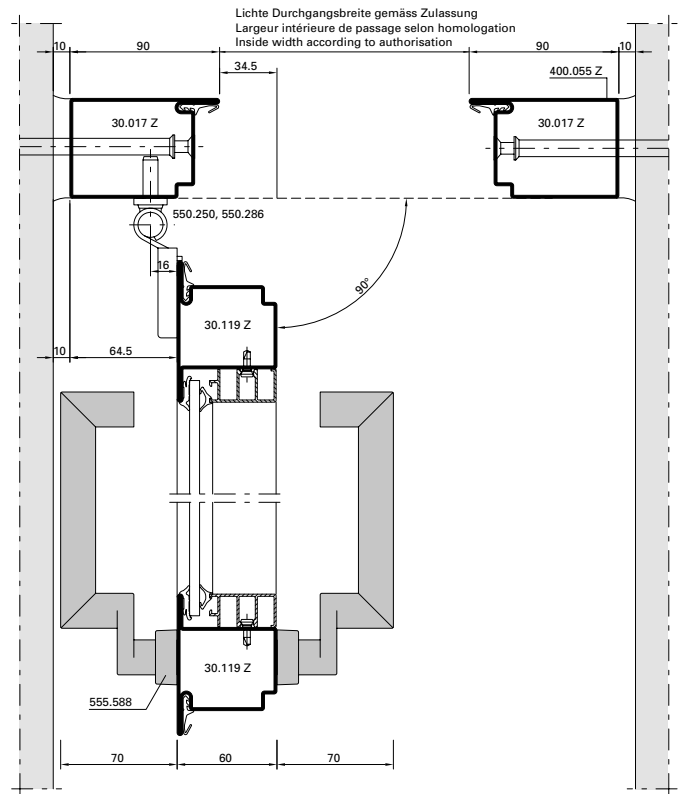

DXF **DWG** 41-0301-E-018

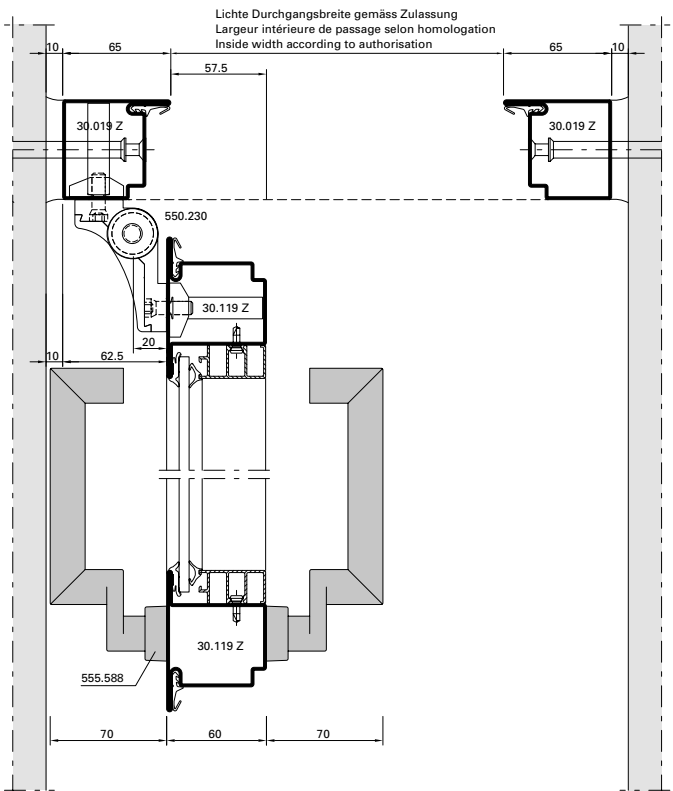

DXF **DWG** 41-0301-E-019

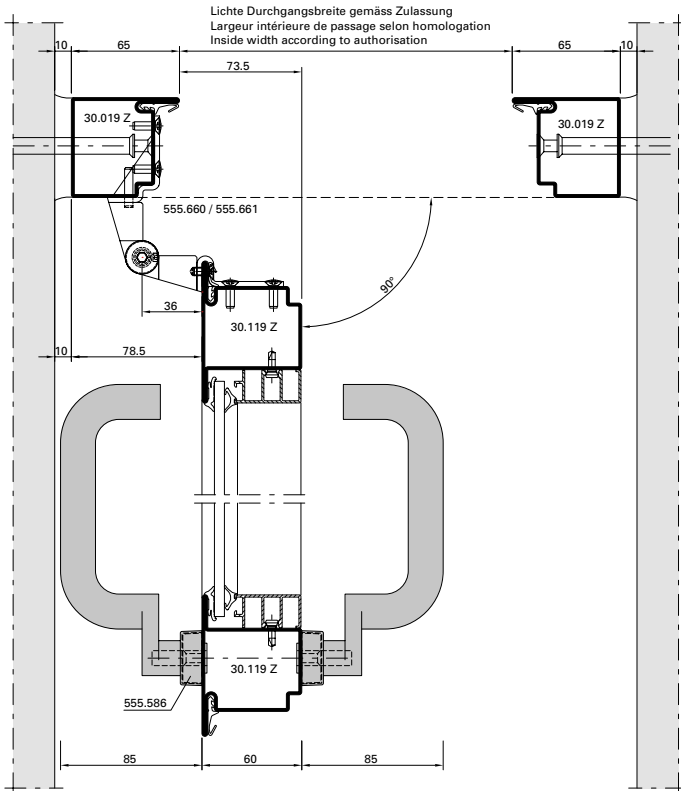

DXF **DWG** 41-0301-E-023

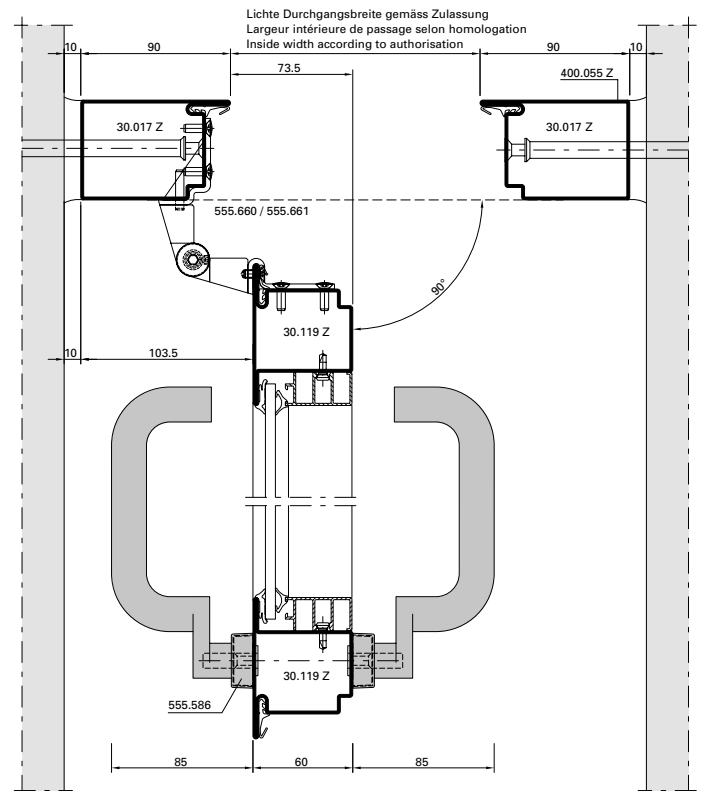

DXF **DWG** 41-0301-E-022

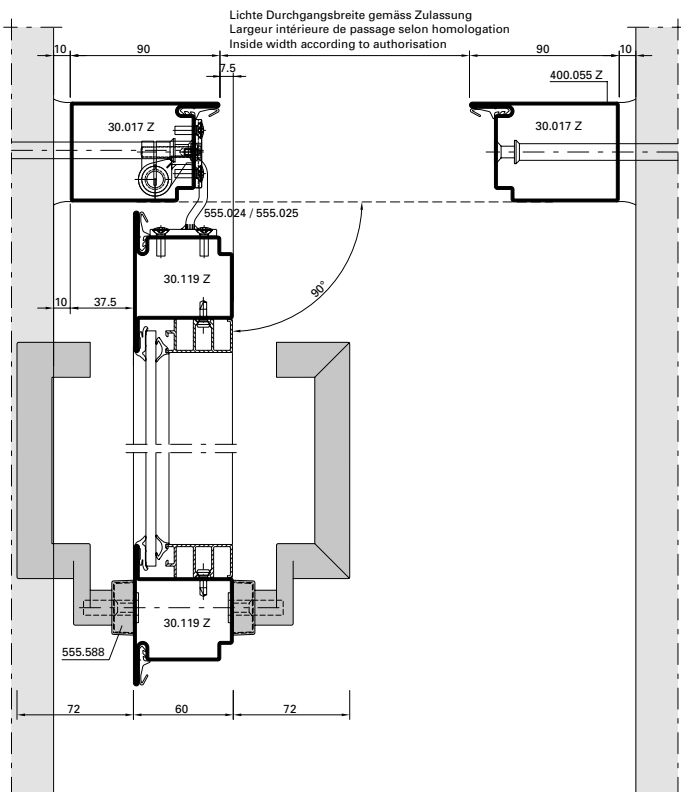

DXF **DWG** 41-0301-E-021

Anschlüsse am Bau im Massstab 1:2
Raccords au mur à l'échelle 1:2
Attachment to structure on scale 1:2

Jansen-Economy 60 RS
Jansen-Economy 60 RS
Jansen-Economy 60 RS

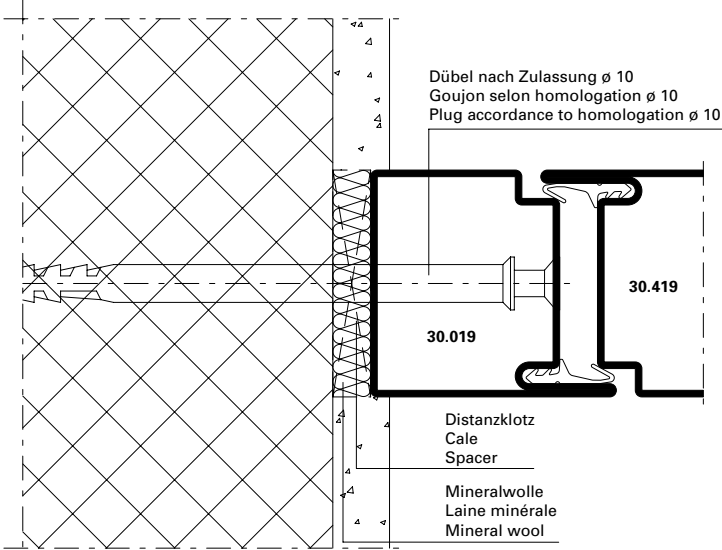

DXF DWG 41-0301-A-014

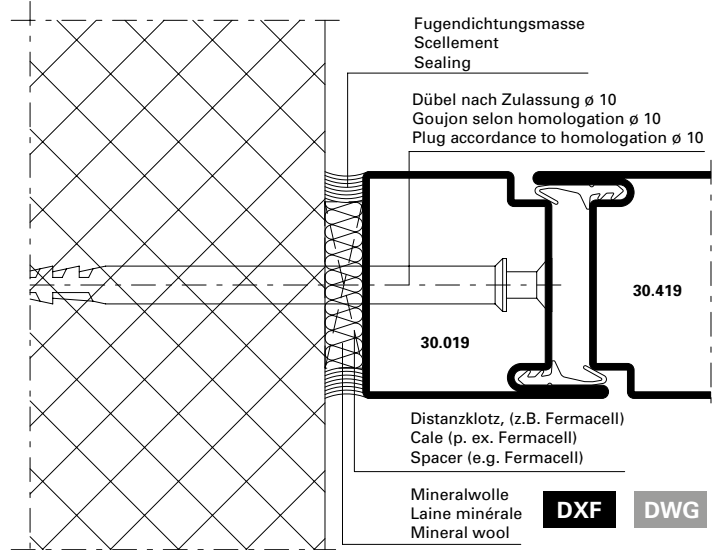

DXF DWG 41-0301-A-015

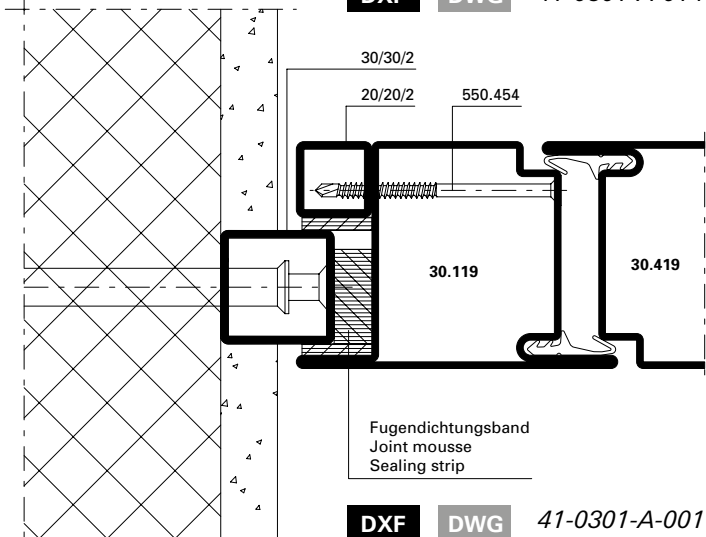

DXF DWG 41-0301-A-001

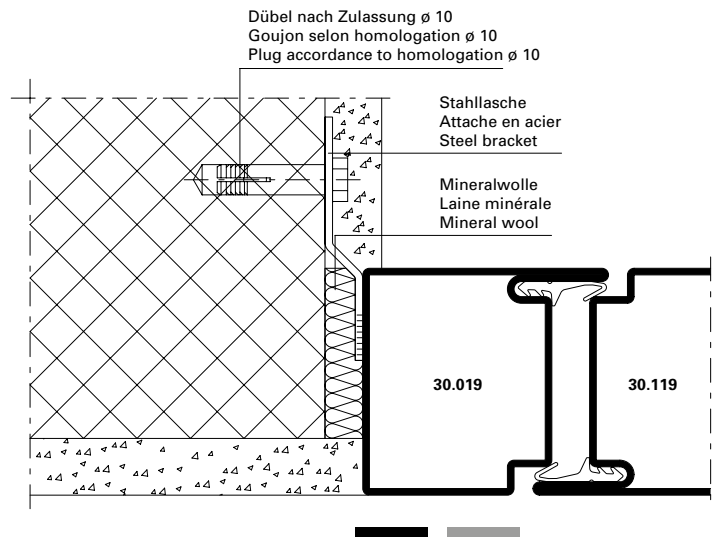

DXF DWG 41-0301-A-002

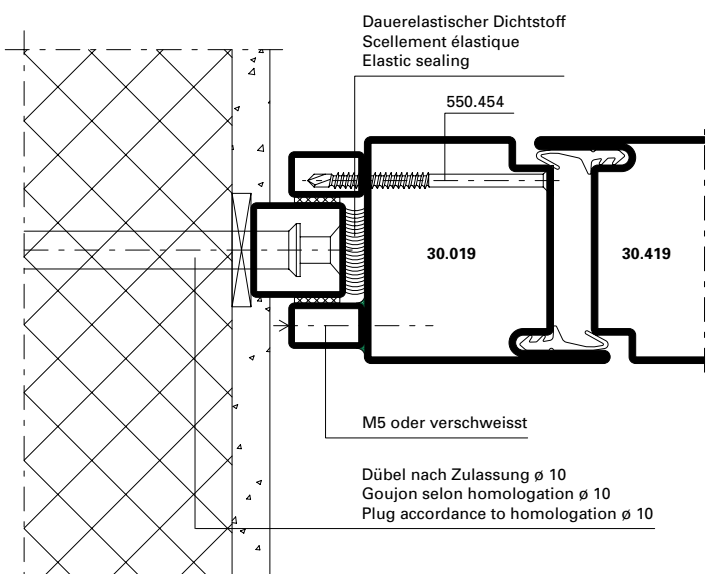

DXF DWG 41-0301-A-003

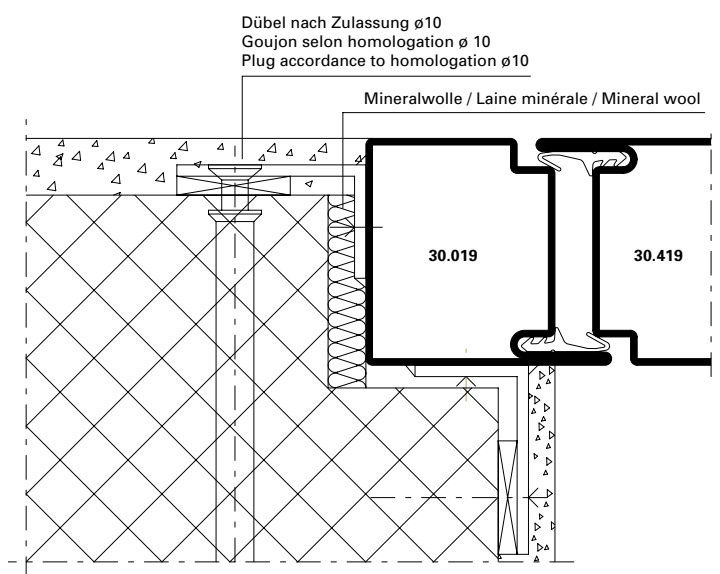

DXF DWG 41-0301-A-016

Anschlüsse am Bau im Masstab 1:2
Raccords au mur à l'échelle 1:2
Attachment to structure on scale 1:2

Jansen-Economy 60 RS
 Jansen-Economy 60 RS
 Jansen-Economy 60 RS

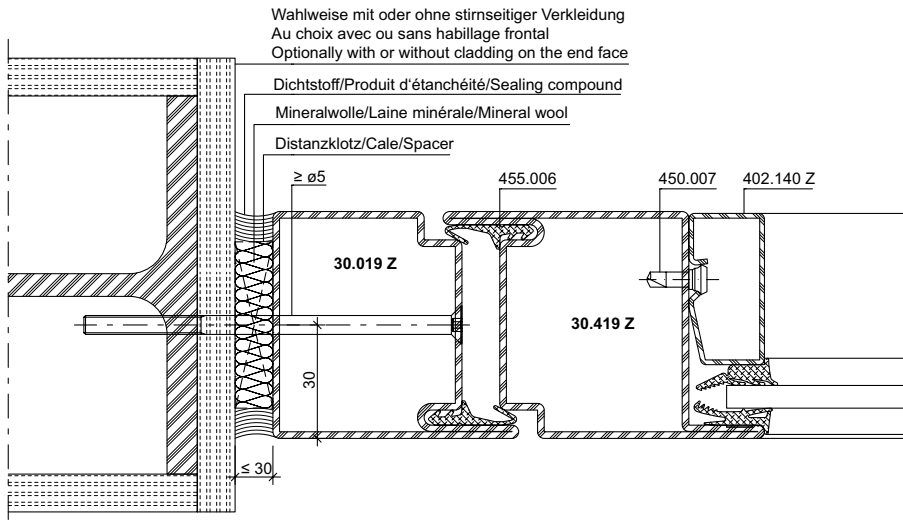

DXF **DWG** 41-0301-A-004

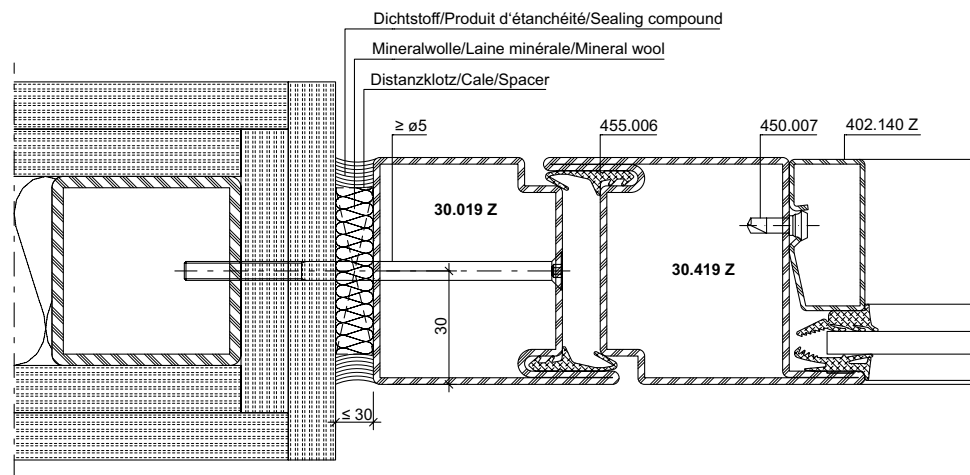

DXF **DWG** 41-0301-A-006

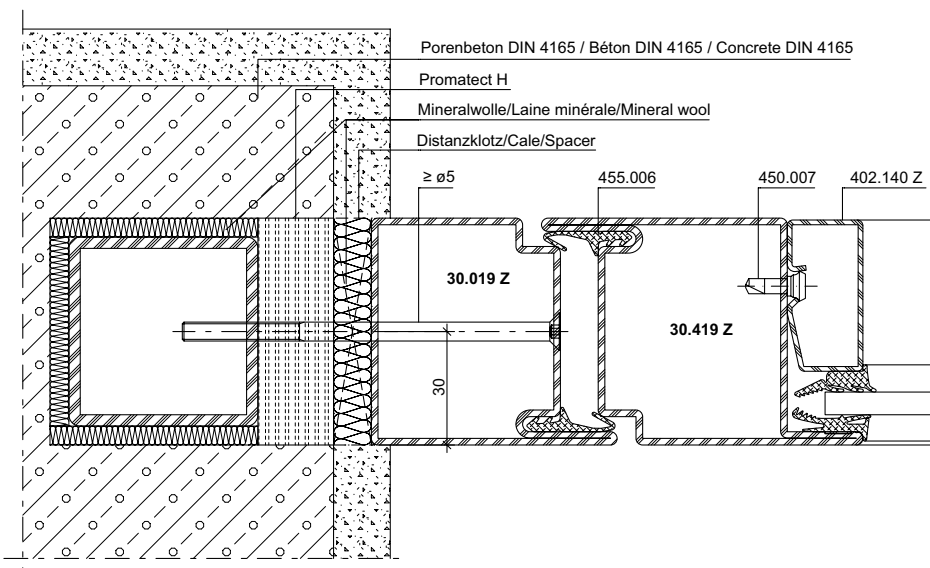

DXF **DWG** 41-0301-A-008

Anschlüsse am Bau im Massstab 1:2

Raccords au mur à l'échelle 1:2

Attachment to structure on scale 1:2

Jansen-Economy 60 RS

Jansen-Economy 60 RS

Jansen-Economy 60 RS

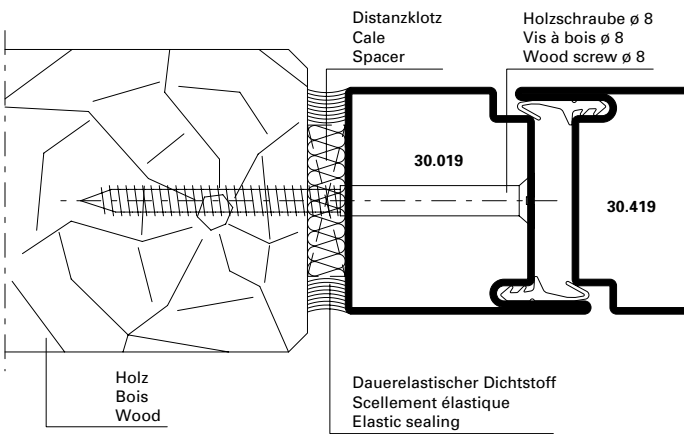

DXF **DWG** 41-0301-A-005

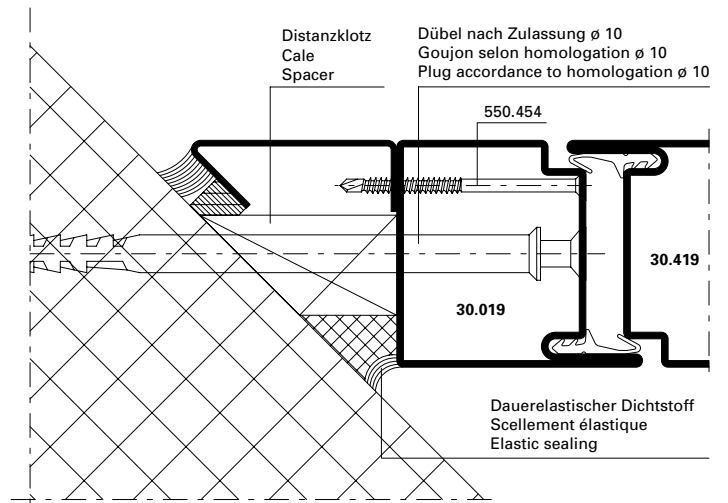

DXF **DWG** 41-0301-A-007

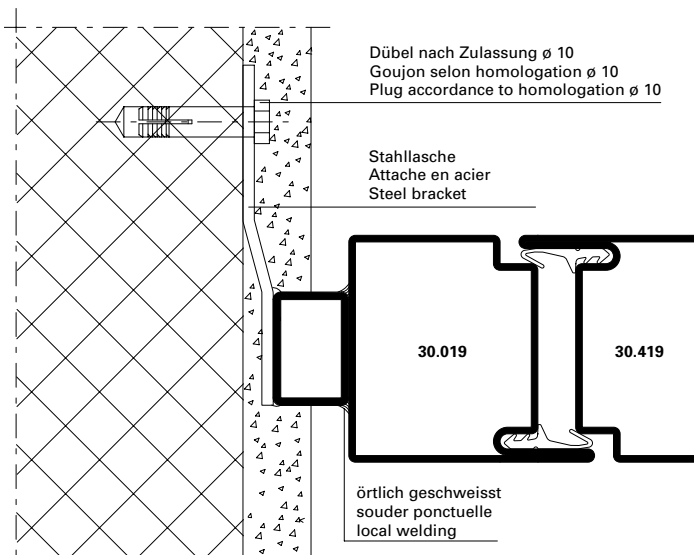

DXF **DWG** 41-0301-A-009

41-0301-A-011

DXF DWG

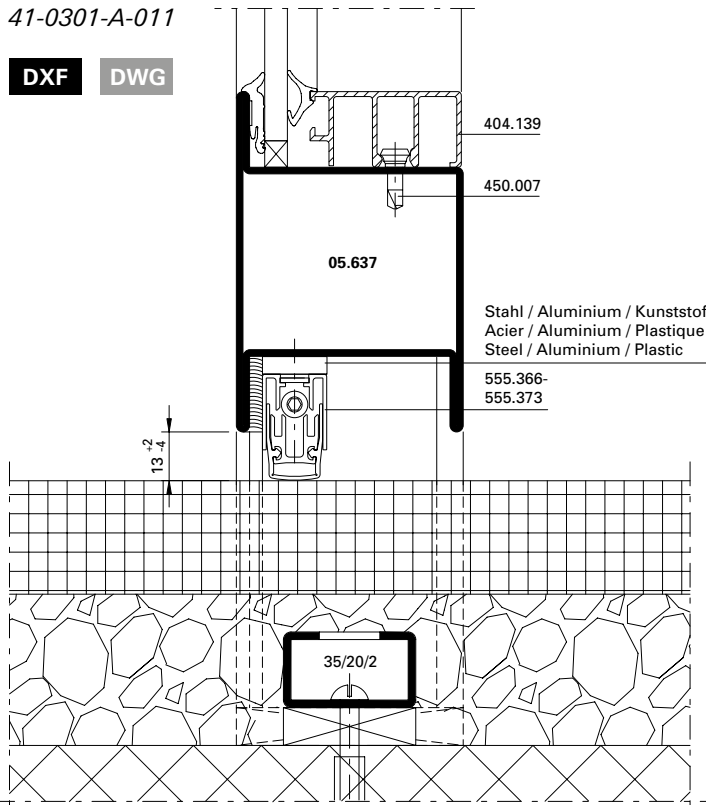

41-0301-A-013

DXF DWG

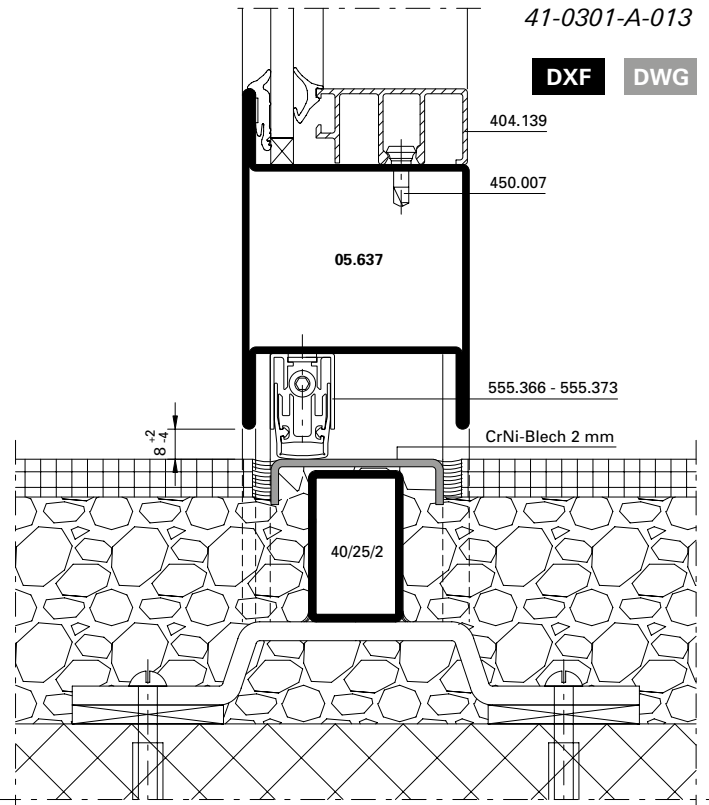

41-0301-A-010

DXF DWG

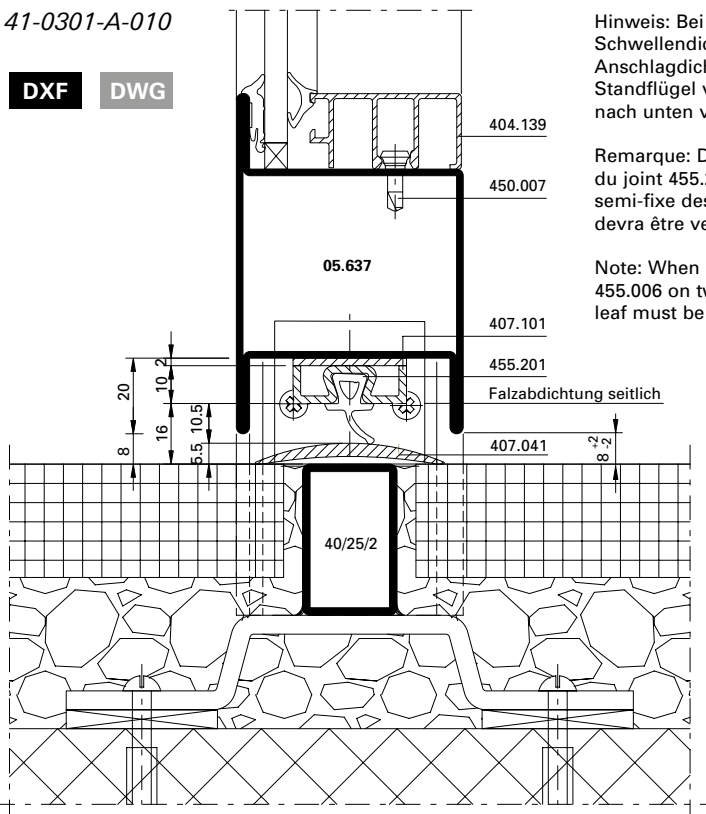

Hinweis: Bei Verwendung der Schwelldichtung 455.201 oder Anschlagdichtung 455.006 muss der Standflügel von zweiflügeligen Türen nach unten verriegelt werden.

Remarque: Dans le cas de l'utilisation du joint 455.201 ou 455.006, le vantail semi-fixe des portes à deux vantaux devra être verrouillé aussi en bas.

Note: When using gasket 455.201 or 455.006 on two leaf doors the fixed leaf must be locked towards the bottom.

41-0301-A-012

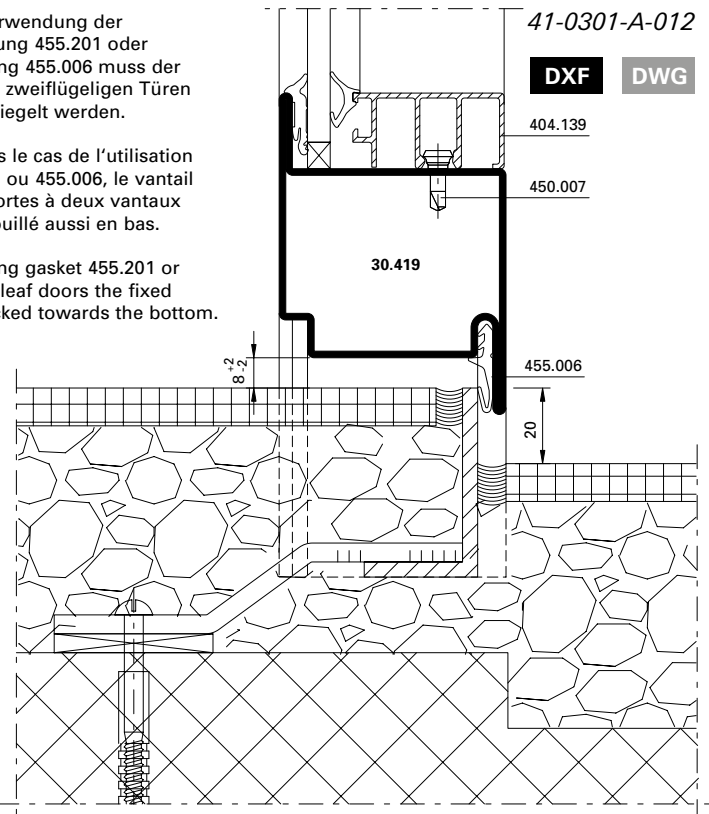

DXF DWG



Einflügelige Türen,
 auswärts öffnend,
 Flügelhöhe ≤ 2200 mm

Porte à un vantail,
 ouvrant vers l'extérieur,
 hauteur du vantail ≤ 2200 mm

Single leaf door,
 outward opening,
 leaf height ≤ 2200 mm

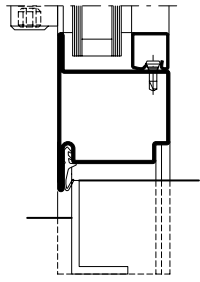
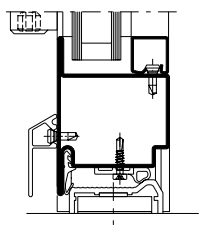
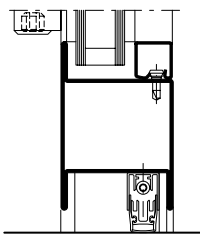
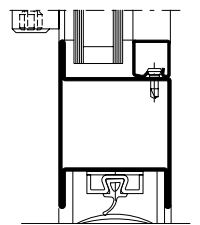
Variante	Beschlag Ferrure Fitting	 EN 12207	 EN 12208	 EN 12210	
Anschlagdichtung Joint de butée Rebate gasket		1	2	1A	C4
		2	2	2A	C4
		3	3	2A	C5
Doppel-Anschlagdichtung Joint de base double Double rebate gasket		1	4	3A	C4
		2	4	3A	C4
		3	4	5A	C5
Senkdichtung Joint seuil Drop seal		1	2	1A	C4
		2	2	2A	C4
		3	3	2A	C5
Auflaufdichtung Joint de contact Ramp seal		1	2	0	C4
		2	2	0	C4
		3	2	0	C5

1 Fallenriegel-Schloss
 Serrure à mortaiser
 Latch and bolt lock





2 Schloss mit Obenverriegelung
 Serrure avec verrouillage supérieur
 Lock with top locking point

3 Mehrfachverriegelungs-Schloss
 Serrure à verrouillage multiple
 Multipoint lock

Einflügelige Türen,
 einwärts öffnend,
 Flügelhöhe ≤ 2200 mm

Porte à un vantail,
 ouvrant vers l'intérieur,
 hauteur du vantail ≤ 2200 mm

Single leaf door,
 inward opening,
 leaf height ≤ 2200 mm

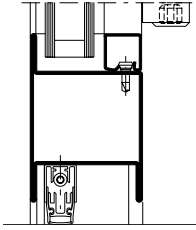
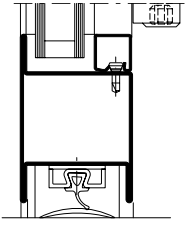
Variante		Beschlag Ferrure Fitting	 EN 12207	 EN 12208	 EN 12210
Senkdichtung Joint seuil Drop seal		❶	2	0	C4
		❷	2	0	C4
		❸	3	1A	C5
Auflaufdichtung Joint de contact Ramp seal		❶	2	0	C4
		❷	2	0	C4
		❸	2	0	C5

❶ Fallenriegel-Schloss
 Serrure à mortaiser
 Latch and bolt lock



❷ Schloss mit Obenverriegelung
 Serrure avec verrouillage supérieur
 Lock with top locking point

❸ Mehrfachverriegelungs-Schloss
 Serrure à verrouillage multiple
 Multipoint lock

Einflügelige Türen,
 auswärts öffnend,
 Flügelhöhe ≤ 3000 mm

Porte à un vantail,
 ouvrant vers l'extérieur,
 hauteur du vantail ≤ 3000 mm

Single leaf door,
 outward opening,
 leaf height ≤ 3000 mm

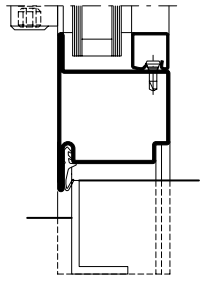
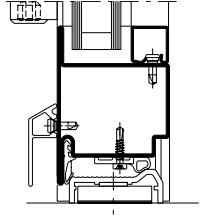
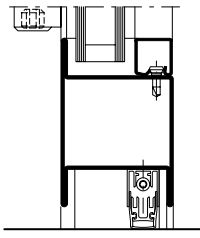
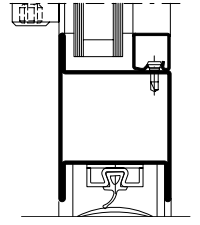
Variante	Beschlag Ferrure Fitting	 EN 12207	 EN 12208	 EN 12210
Anschlagdichtung Joint de butée Rebate gasket 	1	1	0	C1
	2	1	0	C1
	3	1	0	C2
Doppel-Anschlagdichtung Joint de base double Double rebate gasket 	1	1	1A	C1
	2	1	1A	C1
	3	2	2A	C2
Senkdichtung Joint seuil Drop seal 	1	1	0	C1
	2	1	0	C1
	3	1	0	C2
Auflaufdichtung Joint de contact Ramp seal 	1	0	0	C1
	2	0	0	C1
	3	1	0	C2

1 Fallenriegel-Schloss
 Serrure à mortaiser
 Latch and bolt lock





2 Schloss mit Obenverriegelung
 Serrure avec verrouillage supérieur
 Lock with top locking point

3 Mehrfachverriegelungs-Schloss
 Serrure à verrouillage multiple
 Multipoint lock

Einflügelige Türen,
 einwärts öffnend,
 Flügelhöhe ≤ 3000 mm

Porte à un vantail,
 ouvrant vers l'intérieur,
 hauteur du vantail ≤ 3000 mm

Single leaf door,
 inward opening,
 leaf height ≤ 3000 mm

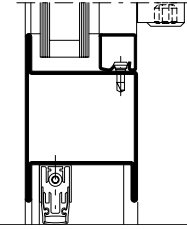
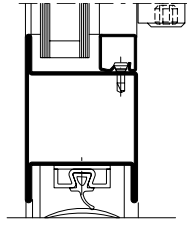
Variante		Beschlag Ferrure Fitting	 EN 12207	 EN 12208	 EN 12210
Senkdichtung Joint seuil Drop seal		❶	1	0	C1
		❷	1	0	C1
		❸	1	0	C2
Auflaufdichtung Joint de contact Ramp seal		❶	0	0	C1
		❷	0	0	C1
		❸	1	0	C2

❶ Fallenriegel-Schloss
 Serrure à mortaiser
 Latch and bolt lock



❷ Schloss mit Obenverriegelung
 Serrure avec verrouillage supérieur
 Lock with top locking point

❸ Mehrfachverriegelungs-Schloss
 Serrure à verrouillage multiple
 Multipoint lock

Zweiflügelige Türen,
 auswärts öffnend,
 Flügelhöhe ≤ 2200 mm

Porte à deux vantaux,
 ouvrant vers l'extérieur,
 hauteur du vantail ≤ 2200 mm

Double leaf door,
 outward opening,
 leaf height ≤ 2200 mm

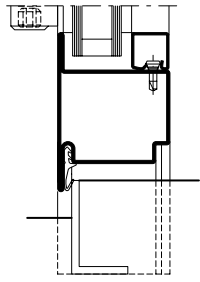
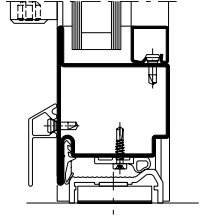
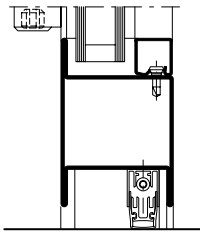
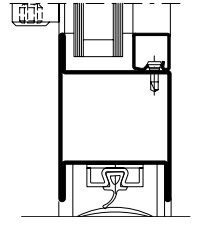
Variante	Beschlag Ferrure Fitting	 EN 12207	 EN 12208	 EN 12210
Anschlagdichtung Joint de butée Rebate gasket 	1	2	1A	C2
	2	2	2A	C2
	3	2	2A	C3
Doppel-Anschlagdichtung Joint de base double Double rebate gasket 	1	2	2A	C2
	2	2	2A	C2
	3	3	3A	C3
Senkdichtung Joint seuil Drop seal 	1	2	1A	C2
	2	2	2A	C2
	3	2	2A	C3
Auflaufdichtung Joint de contact Ramp seal 	1	2	0	C2
	2	2	0	C2
	3	2	0	C3

1 Fallenriegel-Schloss
 Serrure à mortaiser
 Latch and bolt lock





2 Schloss mit Obenverriegelung
 Serrure avec verrouillage supérieur
 Lock with top locking point

3 Mehrfachverriegelungs-Schloss
 Serrure à verrouillage multiple
 Multipoint lock

Zweiflügelige Türen,
 einwärts öffnend,
 Flügelhöhe ≤ 2200 mm

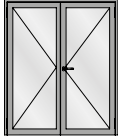
Porte à deux vantaux,
 ouvrant vers l'intérieur,
 hauteur du vantail ≤ 2200 mm

Double leaf door,
 inward opening,
 leaf height ≤ 2200 mm

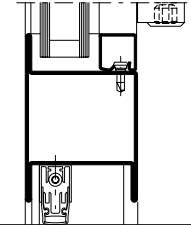
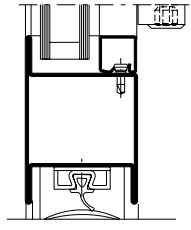
Variante		Beschlag Ferrure Fitting	 EN 12207	 EN 12208	 EN 12210
Senkdichtung Joint seuil Drop seal		❶	2	0	C2
		❷	2	0	C2
		❸	2	0	C3
Auflaufdichtung Joint de contact Ramp seal		❶	2	0	C2
		❷	2	0	C2
		❸	2	0	C3

❶ Fallenriegel-Schloss
 Serrure à mortaiser
 Latch and bolt lock



❷ Schloss mit Obenverriegelung
 Serrure avec verrouillage supérieur
 Lock with top locking point

❸ Mehrfachverriegelungs-Schloss
 Serrure à verrouillage multiple
 Multipoint lock

Zweiflügelige Türen,
 auswärts öffnend,
 Flügelhöhe ≤ 3000 mm

Porte à deux vantaux,
 ouvrant vers l'extérieur,
 hauteur du vantail ≤ 3000 mm

Double leaf door,
 outward opening,
 leaf height ≤ 3000 mm

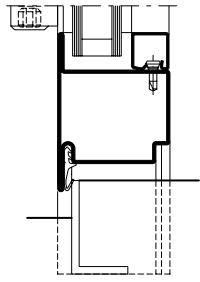
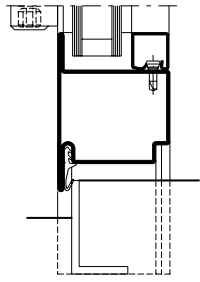
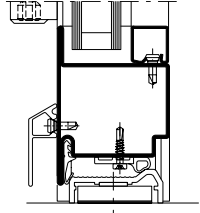
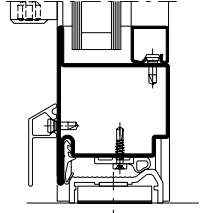
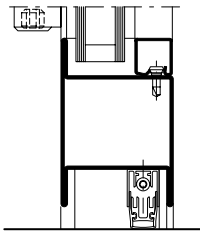
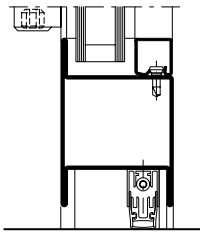
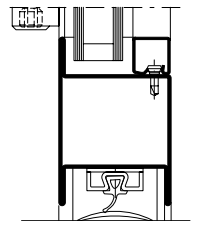
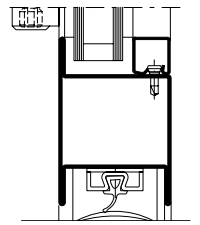
Variante	Beschlag Ferrure Fitting	 EN 12207	 EN 12208	 EN 12210		
Anschlagdichtung Joint de butée Rebate gasket 	Beschlag Ferrure Fitting 	1	0	0	C1	
		2	0	0	0	C1
		3	1	0	0	C2
Doppel-Anschlagdichtung Joint de base double Double rebate gasket 	Beschlag Ferrure Fitting 	1	1	0	C1	
		2	1	0	0	C1
		3	2	0	0	C2
Senkdichtung Joint seuil Drop seal 	Beschlag Ferrure Fitting 	1	0	0	C1	
		2	0	0	0	C1
		3	1	0	0	C2
Aufaufdichtung Joint de contact Ramp seal 	Beschlag Ferrure Fitting 	1	0	0	C1	
		2	0	0	0	C1
		3	1	0	0	C2

1 Fallenriegel-Schloss
 Serrure à mortaiser
 Latch and bolt lock





2 Schloss mit Obenverriegelung
 Serrure avec verrouillage supérieur
 Lock with top locking point

3 Mehrfachverriegelungs-Schloss
 Serrure à verrouillage multiple
 Multipoint lock

Zweiflügelige Türen,
 einwärts öffnend,
 Flügelhöhe ≤ 3000 mm

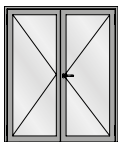
Porte à deux vantaux,
 ouvrant vers l'intérieur,
 hauteur du vantail ≤ 3000 mm

Double leaf door,
 inward opening,
 leaf height ≤ 3000 mm

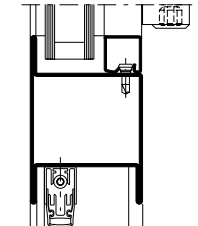
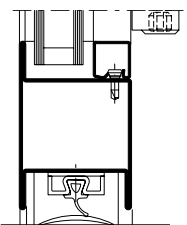
Variante		Beschlag Ferrure Fitting	 EN 12207	 EN 12208	 EN 12210
Senkdichtung Joint seuil Drop seal		1	0	0	C1
		2	0	0	C1
		3	1	0	C2
Auflaufdichtung Joint de contact Ramp seal		1	0	0	C1
		2	0	0	C1
		3	1	0	C2

U_f-Werte
(nach EN ISO 10077-2:2018-01)

Valeurs U_f
(selon EN ISO 10077-2:2018-01)

U_f values
(according to
EN ISO 10077-2:2018-01)

Auf den folgenden Seiten
finden Sie die U_f-Werte für die
verschiedenen Anwendungen von
Jansen-Economy 60 RS.

Vous trouverez les valeurs U_f
pour les différentes applications
Jansen-Economy 60 RS. dans les
pages qui suivent.

On the following pages you
will find the U_f values for the
various applications for
Jansen-Economy 60 RS.

Sie basieren auf folgenden
Grundlagen:

Elles se basent sur les principes
suivants:

They are based on the following:

Stahl

- Profile bandverzinkter Stahl,
unbeschichtet
- Stahl-Glasleisten
- Trockenverglasung
- Nassverglasung

Acier

- Profilés en bande d'acier zingué,
sans revêtement
- Parcloses en acier
- Vitrage à sec
- Vitrage à mastic

Steel

- Strip galvanised steel profiles,
uncoated
- Steel glazing beads
- Glazing with dry glazing
- Glazing with sealing

U_f-Werte
 (nach EN ISO 10077-2:2018-01)

Valeurs U_f
 (selon EN ISO 10077-2:2018-01)

U_f values
 (according to EN ISO 10077-2:2018-01)

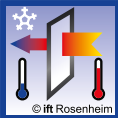
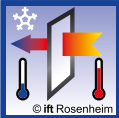
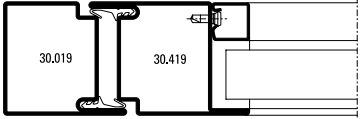
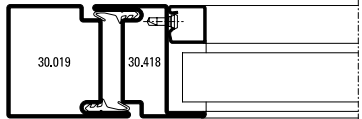
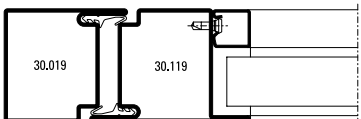
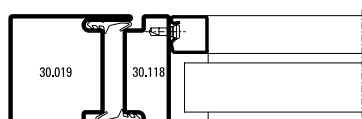
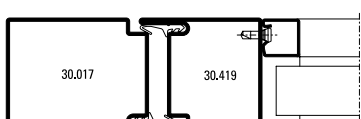
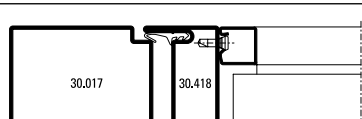
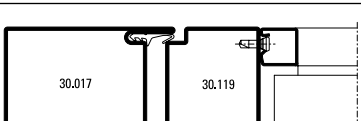
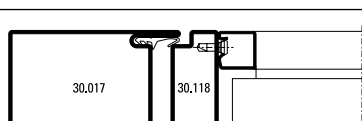
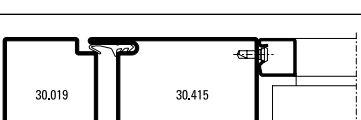
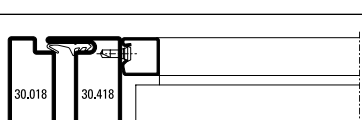
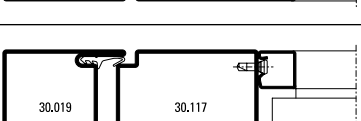
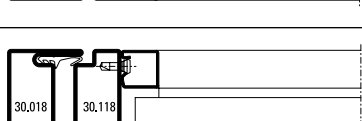
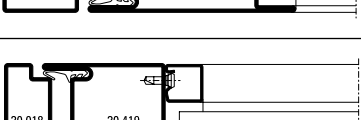
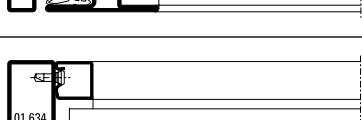
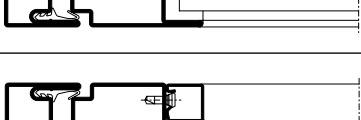
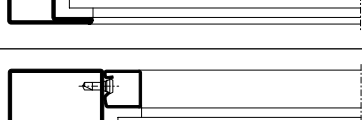
 Füllelementstärken Elements de remplissages Infill elements ≥ 24 mm		 Füllelementstärken Elements de remplissages Infill elements ≥ 24 mm	
	5,5 W/m ² K		5,7 W/m ² K
	5,6 W/m ² K		5,8 W/m ² K
	5,3 W/m ² K		5,5 W/m ² K
	5,3 W/m ² K		5,5 W/m ² K
	5,3 W/m ² K		6,0 W/m ² K
	5,3 W/m ² K		6,1 W/m ² K
	5,6 W/m ² K		6,9 W/m ² K
	5,7 W/m ² K		6,1 W/m ² K

U_f-Werte
 (nach EN ISO 10077-2:2018-01)

Valeurs U_f
 (selon EN ISO 10077-2:2018-01)

U_f values
 (according to EN ISO 10077-2:2018-01)

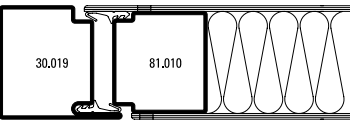
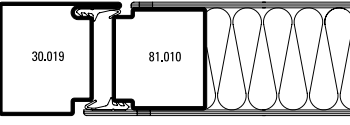
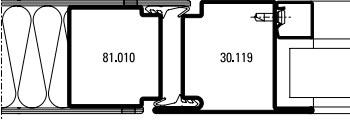
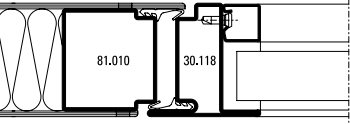
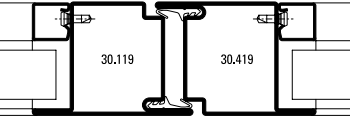
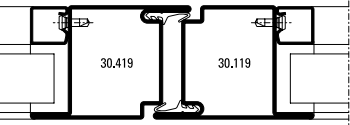
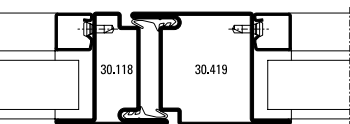
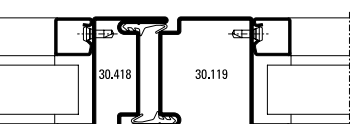

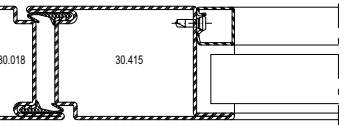
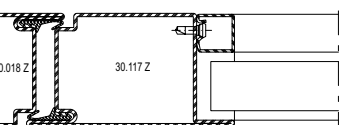
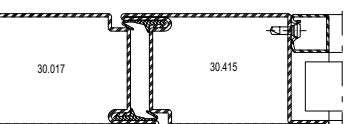
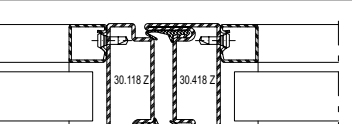
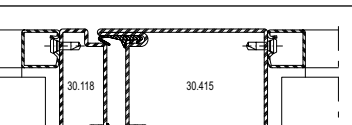
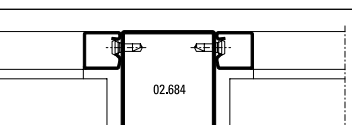
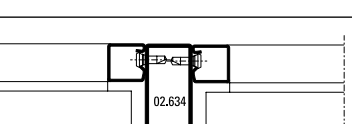
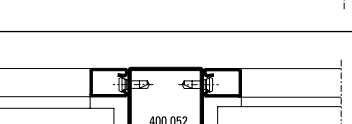
 Füllelementstärken Elements de remplissages Infill elements ≥ 24 mm	
	5,3 W/m²K
	5,3 W/m²K
	5,7 W/m²K
	6,0 W/m²K
	5,8 W/m²K
	5,8 W/m²K
	6,1 W/m²K
	6,1 W/m²K

 Füllelementstärken Elements de remplissages Infill elements ≥ 24 mm	
	5,3 W/m²K
	5,4 W/m²K
	5,1 W/m²K
	6,5 W/m²K
	5,7 W/m²K
	6,3 W/m²K
	7,2 W/m²K
	6,4 W/m²K

U_f-Werte
 (nach EN ISO 10077-2:2018-01)

Valeurs U_f
 (selon EN ISO 10077-2:2018-01)

U_f values
 (according to EN ISO 10077-2:2018-01)

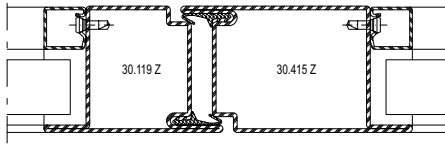
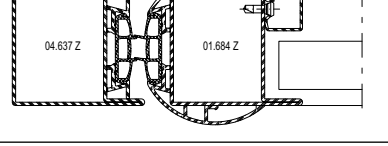
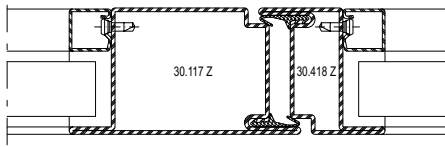
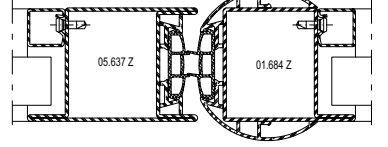
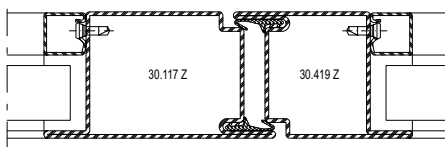
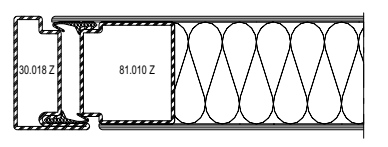
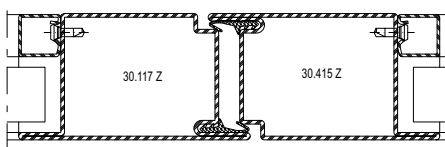
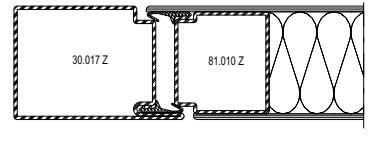
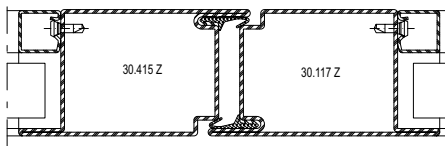
	Füllelementstärken Elements de remplissages Infill elements ≥ 24 mm		Füllelementstärken Elements de remplissages Infill elements ≥ 24 mm
	5,5 W/m²K		5,8 W/m²K
	5,7 W/m²K		6,0 W/m²K
	5,5 W/m²K		5,4 W/m²K
	5,3 W/m²K		5,1 W/m²K
	5,3 W/m²K		

U_f-Werte
 (nach EN ISO 10077-2:2018-01)

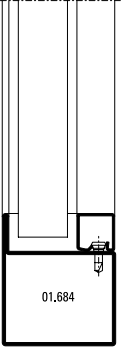
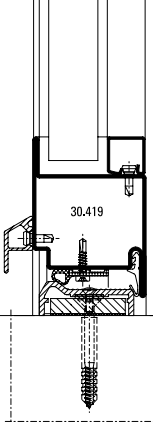
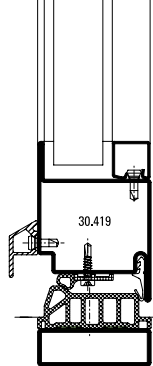
 Füllelementstärken Elements de remplissages Infill elements ≥ 24 mm	
	6,1 W/m ² K
	6,3 W/m ² K
	5,6 W/m ² K

Valeurs U_f
 (selon EN ISO 10077-2:2018-01)

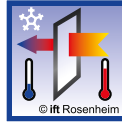
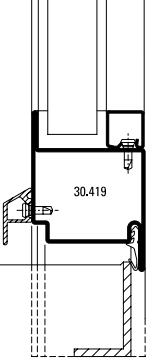
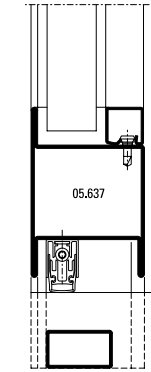
 Füllelementstärken Elements de remplissages Infill elements ≥ 24 mm	
	6,3 W/m ² K
	5,6 W/m ² K

U_f values
 (according to EN ISO 10077-2:2018-01)

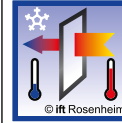
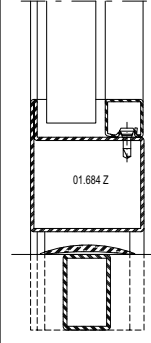
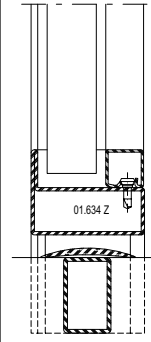
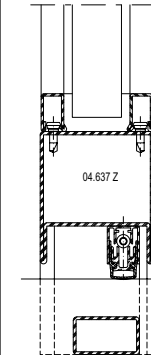
 Füllelementstärken Elements de remplissages Infill elements ≥ 24 mm	
	6,1 W/m ² K
	6,8 W/m ² K
	5,5 W/m ² K

U_f-Werte
 (nach EN ISO 10077-2:2018-01)

Valeurs U_f
 (selon EN ISO 10077-2:2018-01)

U_f values
 (according to EN ISO 10077-2:2018-01)

	Füllelementstärken Elements de remplissages Infill elements ≥ 24 mm
	5,6 W/m²K

	Füllelementstärken Elements de remplissages Infill elements ≥ 24 mm
	5,6 W/m²K

	Füllelementstärken Elements de remplissages Infill elements ≥ 24 mm
	5,7 W/m²K

	4,4 W/m²K
--	------------------

	5,7 W/m²K
--	------------------

	5,2 W/m²K
--	------------------



Schallschutz

Ausführungsvarianten

Die nachfolgende Typenübersicht ergibt einen Überblick über die beurteilten Varianten.

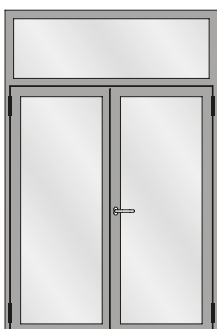
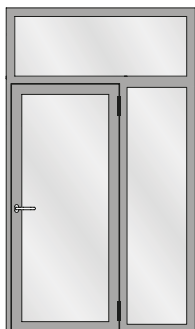
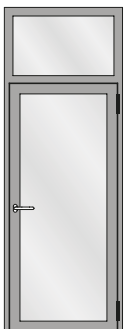
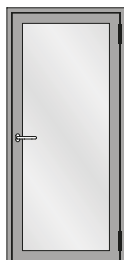

Isolation phonique

Modèles

L'aperçu des types suivant fournit une vue d'ensemble des variantes examinées.

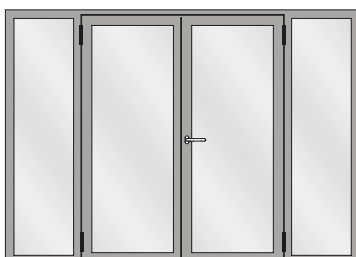
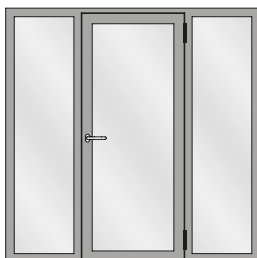
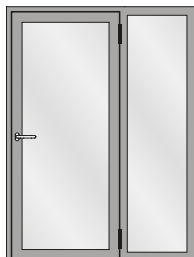
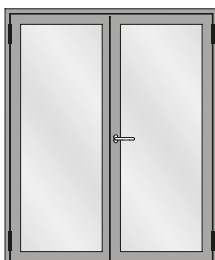

Sound insulation

Design range

The following overview of types provides an overview of the evaluated designs.

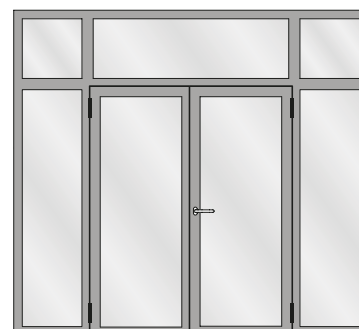
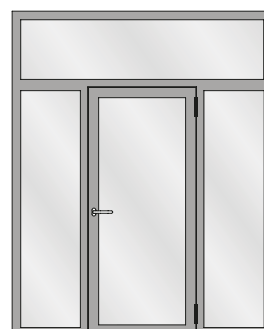

Schallschutz

Isolation phonique

Sound insulation

Tabelle A1

Korrekturtabelle für Jansen-Economy-Türen mit Glasfüllungen

Tableau A1

Tableau de correction pour les portes Jansen-Economy avec vitrage

Table A1

Correction table for Jansen-Economy doors with glass

	1	2	3	4	5	6	7	8	9	10	11
	Türe mit zwei absenkba- ren Bodendichtungen Porte avec deux joint seuil automatique Door with two threshold gaskets that can be lowered $R_{w(C, Ctr)}$ dB	Glas Verre Glass $R_{w, P, Glas}$ dB	Korrekturen Corrections Corrections K_S dB K_{FV} dB K_{Nass} dB K_{1aB} dB $K_{W/S}$ dB $K_{G 0,4}$ dB $K_{G 1,8}$ dB $K_{G 2,6}$ dB $K_{G 3,2}$ dB								
1	32 (-1; -5)	31	0	-1	0	0	0	0	-1	-2	-3
2	33 (-1; -5)	32	0	-1	0	0	0	0	-1	-2	-3
3	35 (-1; -5)	34	0	-1	0	0	0	0	-1	-2	-3
4	36 (-2; -5)	35	0	-1	-1	0	0	0	-1	-2	-3
5	37 (-2; -5)	37	0	0	-1	0	-1	0	-1	-2	-3
6	38 (-2; -5)	39	0	0	-1	-1	-1	0	-1	-2	-3
7	39 (-2; -5)	40	0	0	-1	-1	-1	0	-1	-2	-3
8	40 (-2; -5)	41	0	0	-1	-1	-2	-1	-1	-2	-3
9	41 (-2; -5)	42	0	0	-1	-1	-2	-2	-1	-2	-3
10	42 (-2; -5)	43	-1	0	-1	-1	-2	-2	-1	-2	-3
11	42 (-2; -5)	44	-1	0	-1	-1	-2	-2	-1	-2	-3
12	43 (-2; -5)	45	-1	+1	-1	-1	-3	-3	-1	-2	-3
13	44 (-2; -5)	49	-1	+1	-1	-2	-3	-3	-1	-2	-3

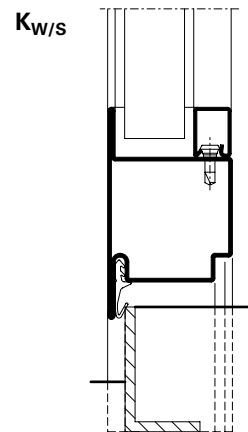
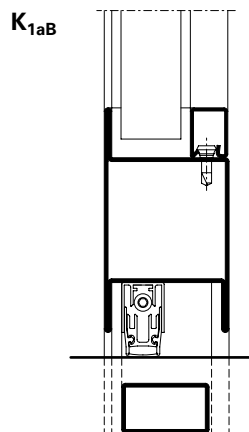
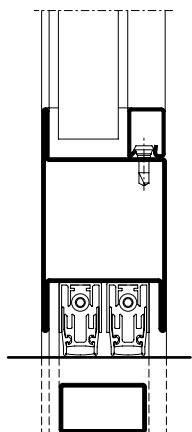

Schallschutz

Der aus der Tabelle A1 abzulesende Wert für die Schalldämmung $R_{w, Tür}$ beträgt:

Isolation phonique

La valeur à relever sur le tableau A1 concernant l'isolement contre les sons aériens $R_{w, Porte}$ est la suivante:

Sound insulation

The value taken from table A1 for the sound insulation $R_{w, Door}$ is:

$$R_{w, Tür} = R_w + K_S + K_{FV} + K_{Nass} + K_{1aB} + K_{W/S} + K_{Band} + K_{G 0,4} + K_{G 1,8} + K_{G 2,6} + K_{G 3,2} \text{ dB}$$

- R_w** bewertetes Schalldämm-Mass der Türe in Abhängigkeit von der Schalldämmung $R_{w,P, Glas}$
- $R_{w,P, Glas}$** bewertetes Schalldämm-Mass der Verglasung (Prüfwert nach ISO 140-3, mit Prüfnachweis einer PÜZ-Stelle). Alternativ können Tabellenwerte nach DIN EN 12758, Abschnitt 6 verwendet werden
- K_S** Korrekturwert für zweiflügelige Türen
- K_{FV}** Korrekturwert für Festverglasungen mit erhöhtem Scheibenanteil
- K_{Nass}** Korrekturwert für Nassverglasung
- K_{1aB}** Korrekturwert für Türen mit einer absenkbaren Bodendichtung
- K_{Band}** Korrekturwert bei Verwendung von Anschlagbändern, die eine Dichtungsebene unterbrechen ($K_{Band} = - 0,5 \text{ dB pro Band}$)
- $K_{W/S}$** Korrekturwert für Türen mit einer Anschlagsschwelle
- $K_{G 0,4}$** Korrekturwert für Einzelscheiben mit einer Glasfläche $\leq 0,4 \text{ m}^2$. Die Korrektur gilt auch für Konstruktionen mit glasteilenden Sprossen.
- $K_{G 1,8}$** Korrekturwert für Einzelscheiben mit einer Glasfläche $\geq 1,8 \text{ m}^2$
- $K_{G 2,6}$** Korrekturwert für Einzelscheiben mit einer Glasfläche $\geq 2,6 \text{ m}^2$
- $K_{G 3,2}$** Korrekturwert für Einzelscheiben mit einer Glasfläche $\geq 3,2 \text{ m}^2$

- R_w** Mesure d'isolement contre les sons aériens des portes évaluée suivant l'isolement phonique $R_{w,P, Glas}$
- $R_{w,P, Glas}$** Cote d'isolement acoustique du vitrage évalué (valeur contrôlée selon ISO 140-3 avec certificat d'un bureau de contrôle, de surveillance ou de certification). Il est également possible d'utiliser les valeurs selon le tableau DIN EN 12758, section 6
- K_S** Valeur de correction pour portes à deux vantaux
- K_{FV}** Valeur de correction pour vitrages fixes à fort pourcentage de vitre
- K_{Nass}** Valeur de correction pour vitrage avec mastic
- K_{1aB}** Valeur de correction pour portes avec un joint seuil automatique
- K_{Band}** Valeur corrective en cas d'utilisation de paumelles qui interrompent un plan d'étanchéité ($K_{Band} = - 0,5 \text{ dB par paumelle}$)
- $K_{W/S}$** Valeur de correction pour portes avec un seuil de butée
- $K_{G 0,4}$** Valeur de correction pour vitres individuelles avec une surface vitrée $\leq 0,4 \text{ m}^2$. La correction s'applique aussi aux constructions à meneaux séparant les vitres.
- $K_{G 1,8}$** Valeur de correction pour vitres individuelles avec surface vitrée $\geq 1,8 \text{ m}^2$
- $K_{G 2,6}$** Valeur de correction pour vitres individuelles avec surface vitrée $\geq 2,6 \text{ m}^2$
- $K_{G 3,2}$** Valeur de correction pour vitres individuelles avec surface vitrée $\geq 3,2 \text{ m}^2$

- R_w** Airborne sound reduction index of doors depending on the sound insulation $R_{w,P, Glas}$
- $R_{w,P, Glas}$** Airborne sound reduction index (test value in accordance with ISO 140-3, with a test certificate from a recognised testing, inspection or certification body). Alternatively, the tabulated values in DIN EN 12758, Section 6 may be used
- K_S** Correction value for double-leaf doors
- K_{FV}** Correction value for fixed glazing with increased proportion of pane
- K_{Nass}** Correction value for glazing with sealing
- K_{1aB}** Correction value for doors with a threshold gasket that can be lowered
- K_{Band}** Correction value when using hinges that interrupt a sealing plane ($K_{Band} = - 0.5 \text{ dB per hinge}$)
- $K_{W/S}$** Correction value for doors with a rebate threshold
- $K_{G 0,4}$** Correction value for single panes with a glass area $\leq 0,4 \text{ m}^2$. The correction also applies to buildings with glazing bars
- $K_{G 1,8}$** Correction value for single panes with a glass area $\geq 1,8 \text{ m}^2$
- $K_{G 2,6}$** Correction value for single panes with a glass area $\geq 2,6 \text{ m}^2$
- $K_{G 3,2}$** Correction value for single panes with a glass area $\geq 3,2 \text{ m}^2$

METALFORM

Jansen-Economy 60 RS (Smoke)

Rauchschutztüren nach EN 1634-3 und EN 16034 aus Stahl

Jansen-Economy 60 RS (Smoke)

Portes coupe-fumée selon EN 1634-3 et EN 16034 en acier

Jansen-Economy 60 RS (Smoke)

Smoke control doors according to EN 1634-3 and EN 16034 in steel

Grafische Planungsdaten wie z.B. Anwendungsbeispiele, Konstruktionsdetails, Anschlüsse am Bau, die in unseren physischen oder elektronischen Dokumentationsunterlagen enthalten sind, sind schematische Darstellungen. Gleiches gilt für digitale Medien wie CAD Dateien oder BIM Modelle.

Sie sollen den ausführenden Metallbauer und/oder Fachplaner bei der Planung und Ausführung eines Projektes unterstützen. Sie sind im konkreten Anwendungsfall durch den ausführenden Metallbauer und/oder Fachplaner auf die Verwendbarkeit im konkreten betroffenen Projekt hinsichtlich rechtlichen/regulatorischen aber auch technischen objektspezifischen Anforderungen zu überprüfen und ggfs. eigenverantwortlich anzupassen.

Bei der Überprüfung, der spezifischen Planung und der Umsetzung sind die objektspezifischen Rahmenbedingungen (Material der Bausubstanz, Dimension des Einbauelements, Farbe, Exposition, Lasteinwirkung, etc.) sowie der geltende Stand der Technik einschliesslich aller anwendbaren Normen und technischen Richtlinien eigenverantwortlich zu beachten.

Falls das vorliegende Dokument Differenzen zur aktuellen deutschen Version (Artikel Nr. K1214227) aufweist, gilt in jedem Fall der deutsche Originaltext in der jeweils geltenden Fassung im Jansen Docu Center.

Alle Ausführungen dieser Dokumentation haben wir sorgfältig und nach bestem Wissen zusammengestellt. Wir können aber keine Verantwortung für die Benutzung der vermittelten Vorschläge und Daten übernehmen. Wir behalten uns technische Änderungen ohne Vorankündigung vor.

Les données de planification graphiques, comme les exemples d'application, détails de construction et raccordements au bâtiment, fournies dans notre documentation physique et numérique sont des représentations schématiques. Il en va de même pour les médias numériques comme les fichiers CAD ou modèles BIM.

Leur but est de faciliter la planification et réalisation d'un projet par les constructeurs métalliques et/ou concepteurs. Concrètement, elles doivent être vérifiées par le constructeur métallique et/ou le concepteur et, le cas échéant, modifiées de son propre chef pour s'assurer qu'elles concordent avec le projet concerné et qu'elles répondent aux exigences techniques spécifiques ainsi qu'aux dispositions légales et réglementaires.

Lors de la vérification, de la planification spécifique et de la mise en œuvre, il y a lieu de tenir compte des conditions spécifiques à l'objet (matériaux du bâtiment, dimension de l'élément d'insert, couleur, exposition, effet de charge, etc.) ainsi que de l'état actuel de la technique, y compris toutes les normes et directives techniques applicables.

En cas de divergence entre le présent document et la version allemande (no d'article K1214227), c'est dans tous les cas le texte original allemand qui prévaut dans sa version actuelle disponible dans le Jansen Docu Center.

Nous avons apporté le plus grand soin à l'élaboration de cette documentation. Cependant, nous déclinons toute responsabilité pour l'utilisation faite de nos propositions et de nos données.

Nous nous réservons le droit de procéder à des modifications techniques sans préavis.

Graphical planning data such as application examples, construction details, connections on site that are contained in our physical or electronic documentation components are schematic representations. The same applies to digital media such as CAD files or BIM models.

They are intended to support the metal worker and/or design engineer in planning and executing projects. In the specific case of application they are to be checked by the metal worker and/or design engineer in terms of their usability in the specific project concerned with regard to legal/regulatory and technical property-specific requirements and adjusted if necessary at the latter's own responsibility.

The property-specific underlying conditions (construction material, dimensions of installation element, colour, exposure, load effect etc.) and current state of the art including all applicable norms and technical guidelines are to be taken into consideration at the metal worker and/or design engineer's own responsibility during the review, specific planning and implementation.

If there are any differences between this document and the current German version (item number K1214227), the latest version of the original German text in the Jansen Docu Center shall prevail.

All the information contained in this documentation is given to the best of our knowledge and ability. However, we decline all responsibility for the use made of these suggestions and data.

We reserve the right to effect technical modifications without prior warning.

Inhaltsverzeichnis		Jansen-Economy 60 RS	
Sommaire		Jansen-Economy 60 RS	
Content		Jansen-Economy 60 RS	

Systemübersicht	Sommaire du système	Summary of system	2
Merkmale Zulassungen Systemausführungen Typenübersicht	Caractéristiques Homologations Exécutions de système Sommaire des types	Characteristics Authorisations System versions Summary of types	

Profilsortiment	Assortiment de profilé	Range of profiles	12
------------------------	-------------------------------	--------------------------	-----------

Beispiele	Exemples	Examples	16
Schnittpunkte Konstruktionsdetails Anschlüsse am Bau	Coupes de détails Détails de construction Raccords au mur	Section details Construction details Attachment to structure	

Leistungseigenschaften	Caractéristiques de performance	Performance characteristics	28
-------------------------------	--	------------------------------------	-----------







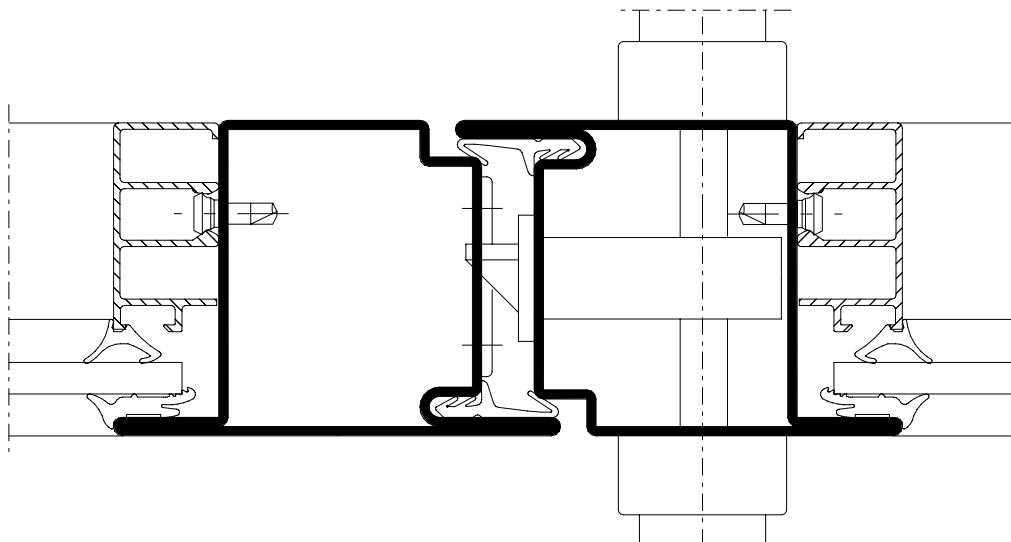

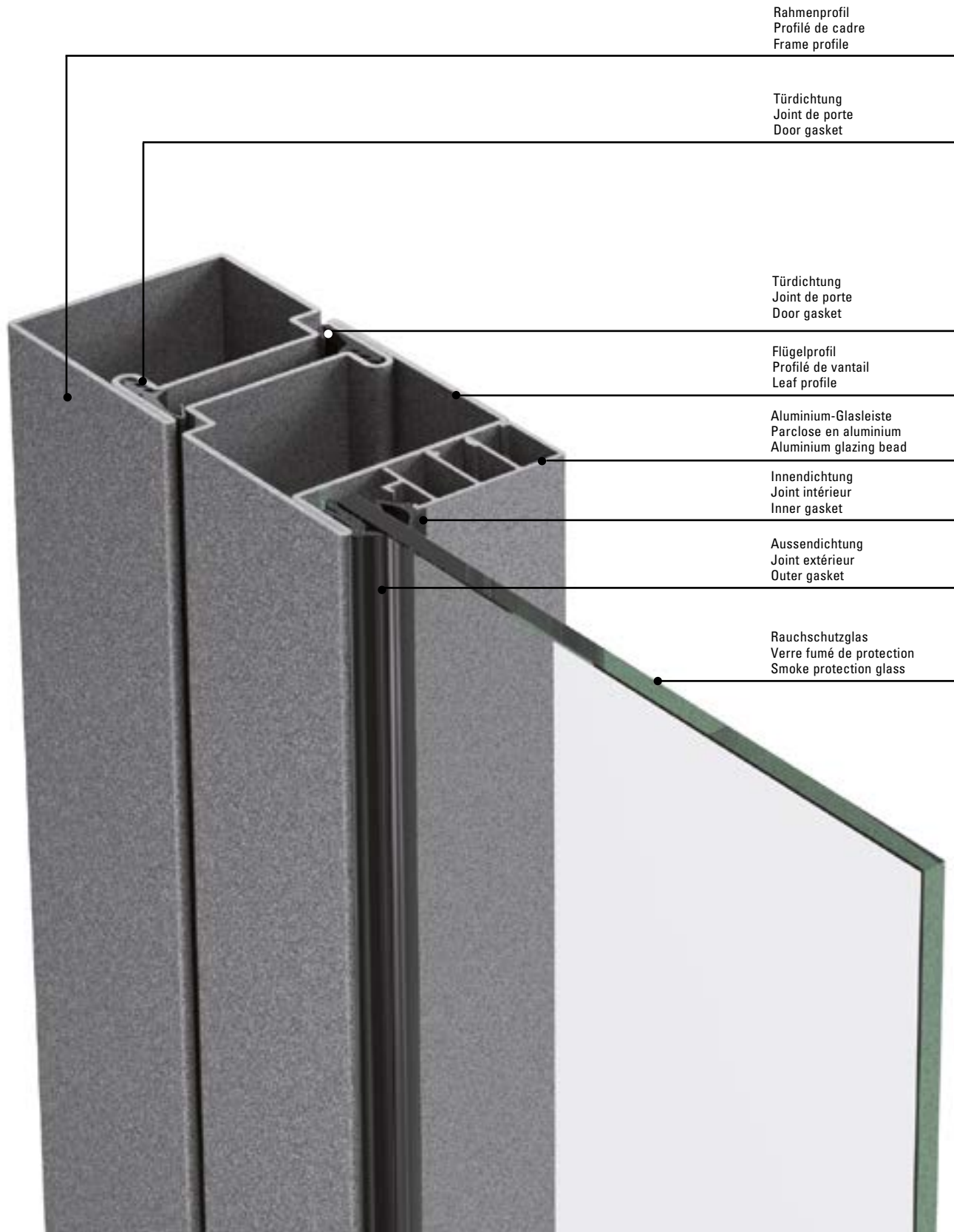

Merkmale
Caractéristiques
Characteristics





Jansen-Economy 60 RS
Jansen-Economy 60 RS
Jansen-Economy 60 RS

- Stahlssystem für Türen und Festverglasungen
 - Bautiefe 60 mm, innen und aussen flächenbündig
 - Schmale Ansichtsbreiten: Rahmen und Flügel ab 105 mm Stulppartie 150 mm
 - Ein- und zweiflüglige Türen, nach innen und aussen öffnend, mit oder ohne Seitenteile und Oberlichter sowie Trennwände
 - Türflügel bis 1750 x 3750 mm (BxH), landesspezifische Zulassung beachten
 - Füllelementstärke von 5 bis 26 mm, Glaseinbau mittels Trocken- oder Nassverglasung
 - Stahlprofile blank oder bandverzinkt
 - Grosses Sortiment an systemgeprüften Türbeschlägen
 - Barrierefreie Schwellenausbildungen
 - Geeignet für Pulver- und Nasslackbeschichtungen
 - Rauchschutztüre gemäss EN 1634-3 und EN 16034, Systemprüfungen nach Produktnorm EN 14351-1
 - Erscheinungsbild deckungsgleich mit anderen Jansen Brandschutzsystemen Jansen-Economy 50, Janisol 2 und Janisol C4
- Système en acier pour portes et vitrages fixes
 - Profondeur de montage 60 mm, montage à fleur à l'intérieur et à l'extérieur
 - Fines largeurs de face: Cadre et vantaux à partir de 105 mm Partie tête 150 mm
 - Portes à un et deux vantaux, ouverture vers l'intérieur et vers l'extérieur, combinables avec parties latérales, impostes et vitrage fixe
 - Vantaux de porte jusqu'à 1750 x 3750 mm (LaxH), il convient de respecter les prescriptions et règlements des divers pays concernés
 - Élément de remplissage de 5 à 26 mm d'épaisseur, Montage du vitrage à sec ou à silicone
 - Profilés en acier brut ou galvanisé en continu
 - Grand assortiment de ferrures de porte homologuées
 - Formes de seuil sans barrière
 - Convient aux revêtements par poudre ou peinture liquide
 - Porte coupe-fumée selon EN 1634-3 et EN 16034, contrôles des systèmes selon la norme produit EN 14351-1
 - Apparence égale comme les autres systèmes coupe-feu de Jansen (Jansen-Economy 50, Janisol 2 et Janisol C4)
- Steel system for doors and fixed glazing
 - 60 mm basic depth, flush-fitted on the inside and outside
 - Narrow face widths: Frame and leaf from 105 mm Meeting stile assembly 150 mm
 - Single and double-leaf doors, inward and outward-opening, can be combined with side-lights, toplight or fixed glazing
 - Door leaf up to 1750 x 3750 mm (WxH), the regulations and bye-laws in force in the particular country must be respected
 - Infill unit thickness of 5 to 26 mm, Glazing installed by means of dry or wet glazing
 - Raw finish or strip galvanised steel profiles
 - Large range of system-tested door fittings
 - Easy-access thresholds
 - Suitable for powder and wet paint coating
 - Smoke-proof door according to EN 1634-3 and EN 16034, system tests in accordance with EN 14351-1
 - Same appearance as the other Jansen fire-resistant systems Jansen-Economy 50, Janisol 2 and Janisol C4





Norm	Eigenschaft Caractéristique Characteristic	Klassifizierung/Wert Classification / Valeur Classification / Value										
		npd	1 (400)	2 (800)	3 (1200)	4 (1600)	5 (2000)	Exxx (>2000)				
 EN 12210	Widerstandsfähigkeit bei Windlast Résistance à la pression du vent Resistance to wind load	npd	1 (400)	2 (800)	3 (1200)	4 (1600)	5 (2000)	Exxx (>2000)				
 EN 12208	Schlagregendichtheit Etanchéité à la pluie battante Watertightness	npd	1A (0)	2A (50)	3A (100)	4A (150)	5A (200)	6A (250)	7A (300)	8A (450)	9A (600)	Exxx (>750)
 EN ISO 10140	Schalldämmung R_w (C, C_{tr}) (dB) Isolation phonique R_w (C, C_{tr}) (dB) Sound insulation R_w (C, C_{tr}) (dB)	npd	bis R_w 44 dB (-2; -5) jusqu'à R_w 44 dB (-2; -5) up to R_w 44 dB (-2; -5)									
 EN ISO 10077-2	Wärmedurchgangskoeffizient U_f (W/(m ² ·K)) Transmission thermique U_f (W/(m ² ·K)) Thermal production U_f (W/(m ² ·K))	npd	ab 5.65 W/m ² K à partir de 5.65 W/m ² K from 5.65 W/m ² K									
 EN 12207	Luftdurchlässigkeit Perméabilité à l'air Air permeability	npd	1 (150)		2 (300)		3 (600)		4 (600)			
 EN 1192	Klassifizierung der Festigkeitsanforderungen Classification des exigences de résistance méc. Classification of strength requirements	npd	1		2		3		4			
 EN 1627	Einbruchhemmung Anti-effraction Burglar resistance	npd	1		2		3		4		5	6
 EN 1522	Durchschusshemmung Résistance aux balles Bullet proofing	npd	FB1	FB2	FB3	FB4	FB5	FB6	FB7	FSG		
 EN 1191 EN 1603	Dauerfunktionsprüfung Durabilité mécanique Mechanical durability		D 1 5'000	2 10'000	3 20'000	4 50'000	5 100'000	6 200'000	7 500'000	8 1'000'000		
 EN 179 EN 1125	Fähigkeit zur Freigabe Capacité au déclenchement Ability to release		Anforderung erfüllt Exigence remplie Requirement fulfilled									

Norm	Eigenschaft Caractéristique Characteristic	Klassifizierung/Wert Classification / Valeur Classification / Value			
 EN 12217	Bedienkräfte Forces de manœuvre Operating forces	npd	0	1	2
 EN 1634-3	Rauchschutz Etanchéité à la fumée Smoke control		S_a / S_{200}		
 EN 16034 EN 13501-2	Selbstschliessung Fermeture automatique Self-closing		C		
 EN 16034	Dauerhaftigkeit der Selbstschliessung gegenüber Alterung (Korrosion) Endurance de la fermeture automatique contre le vieillissement (corrosion) Durability of self-closing against ageing (corrosion)		erzielt atteinte achieved		



Fluchttürsysteme

- Fluchttürsysteme geeignet für Notausgänge und Paniktüren
- Fluchttürnorm EN 179 für Notausgangsverschlüsse erfüllt
- Fluchttürnorm EN 1125 für Panikverschlüsse erfüllt

Systèmes de porte de secours

- Systèmes de porte de secours pour issues de secours et portes panique
- Norme relative aux portes de secours EN 179, remplie pour les fermetures d'issue de secours
- Norme relative aux portes de secours EN 1125, remplie pour les fermetures panique

Emergency exit systems

- Emergency exit systems suitable for emergency exits and panic doors
- Emergency exit standard EN 179 for emergency exit devices fulfilled
- Emergency exit standard EN 1125 for panic exit devices fulfilled



Einbruchhemmende Jansen-Economy 60 RS Türen

- Türgrößen bis 1475 x 3000 mm
- Ein- und zweiflüglige Türen, nach innen und aussen öffnend
- Normal- und Panikfunktion bis RC3
- Geprüft nach EN 1627

Portes anti-effraction Jansen-Economy 60 RS

- Dimensions de porte jusqu'à 1475 x 3000 mm
- Portes à un/deux vantaux ouvrant vers l'intérieur et l'extérieur
- Fonction normale et fonction panique jusqu'à RC3
- Contrôlé selon la norme EN 1627

Burglar-resistant Jansen Economy 60 RS doors

- Door sizes up to 1475 x 3000 mm
- Single and double-leaf doors, inward and outward-opening
- Standard and panic function up to RC3
- Tested in accordance with EN 1627



Verblechte Jansen-Economy 60 RS Türen

- Für ein- und zweiflügelige Brandschutztüren mit oder ohne Seitenteile resp. Oberlichter
- Flächenbündig verblechte Türen
- Bleche können an den Rahmen geschweisst oder geklebt werden
- Mit oder ohne Glasausschnitte möglich

Portes tôlées Jansen-Economy 60 RS

- Pour des portes coupe-feu à un/deux vantaux avec ou sans pièces latérales ou impostes
- Portes tôlées à fleur
- Les tôles peuvent être soudées ou collées sur le cadre
- Possibles avec ou sans panneaux de verre

Jansen Economy 60 RS sheet metal doors

- For single and double-leaf fire doors with or without sidelights or toplights
- Flush-fitted sheet metal doors
- Sheet metal can be welded or bonded to the frame
- Possible with or without glass vision panels

Jansen Docu Center

Die Plattform zum effizienten Arbeiten mit Jansen Dokumentationen. Im Jansen Docu Center stehen alle Produktinformationen jederzeit digital in der aktuellsten Version zur Verfügung: von Architekten-Informationen über Bestell- und Fertigungskatalogen bis hin zu Anleitungen und Prospekten sowie Videos.

Die Inhalte können einfach und schnell aufgerufen werden. Ein für den Anwender komfortables papierloses Arbeiten, das zahlreiche Vorteile bietet.

Download CAD Daten

DXF

DWG

Sie können die Zeichnungen in den Formaten DXF und/oder DWG herunterladen. Klicken Sie auf das entsprechende Icon und der Download erfolgt.

Die Hinweise «Artikelbibliothek/Türbeschläge/Fensterbeschläge» bedeuten, dass Sie mit einem Klick die gesamte Artikelbibliothek des entsprechenden Systems herunterladen (Profile, Beschläge, Glasleisten, Zubehör etc.).

Info und Beratung

Gerne beraten wir Sie persönlich und stehen Ihnen bei Fragen zur Verfügung. Bitte schreiben Sie uns Ihre Anliegen an: info@jansen.com

Jansen Docu Center

La plate-forme pour travailler efficacement avec les documentations Jansen. Le Jansen Docu Center met à votre disposition les informations sur les produits, en format numérique et dans une version actualisée: des catalogues de commande et de fabrication aux instructions et prospectus, en passant par les informations destinées aux architectes et vidéos.

Les contenus sont facilement et rapidement accessibles. Une manière de travailler confortable et offrant de nombreux avantages.

Télécharger fichiers DAO

DXF

DWG

Vous pouvez télécharger les dessins aux formats DXF et/ou DWG. Cliquez sur l'icône correspondante et le téléchargement s'effectuera.

Les indications «Bibliothèque des articles/Ferures de porte/Ferrures de fenêtres» signifie que vous téléchargez la totalité de la bibliothèque des articles du système donné (profilés, ferrures, parclofes, accessoires etc.).

Info et conseils

Nous vous conseillons volontiers individuellement et sommes à votre disposition si vous avez des questions à poser. Veuillez nous envoyer votre requête à: info@jansen.com

Jansen Docu Center

The platform for working efficiently with Jansen documentation. The latest version of all the product information is available digitally at any time in the Jansen Docu Center – from order and fabrication manuals to architect information, instructions and brochures and videos.

The content can be retrieved quickly and easily. The user can work conveniently without paper, which has numerous benefits.

Download CAD files

DXF

DWG

You can download the drawings in DXF and/or DWG format. Click on the relevant icon to begin the download.

The items «Article library/Door fittings/Window fittings» means that you download the entire article library for the corresponding system with one click (profiles, fittings, glazing beads, accessories etc.).

Information and advice

We would be delighted to provide you with advice in person and are available to answer any questions you may have. Please write to us with your queries at: info@jansen.com

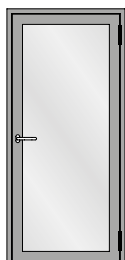

Einflügelige Türe
 Porte à un vantail
 Single leaf door

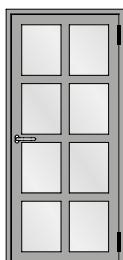

Einflügelige Türe mit Riegel
 Porte à un vantail avec traverse
 Single leaf door with transom

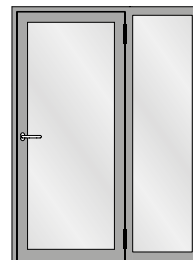

Einflügelige Türe mit festem Seitenteil
 Porte à un vantail avec partie latérale fixe
 Single leaf door with fixed side light

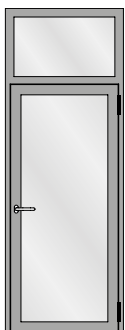

Einflügelige Türe mit festem Oberlicht
 Porte à un vantail avec imposte fixe
 Single leaf door with fixed top light

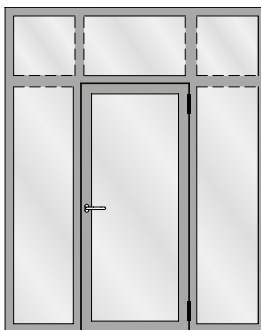

Einflügelige Türe mit zwei festen Seitenteilen
 und festem Oberlicht
 Porte à un vantail avec deux parties latérale fixe
 et imposte fixe
 Single leaf door with two fixed side light and
 fixed top light

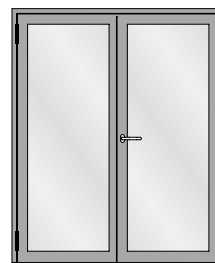

Zweiflügelige Türe
 Porte à deux vantaux
 Double leaf door



Zweiflügelige Türe mit zwei festen Seitenteilen
 Porte à deux vantaux avec deux parties
 latérales fixes
 Double leaf door with two fixed side lights

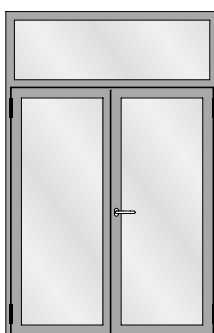

Zweiflügelige Türe mit festem Oberlicht
 Porte à deux vantaux avec imposte fixe
 Double leaf door with fixed top light

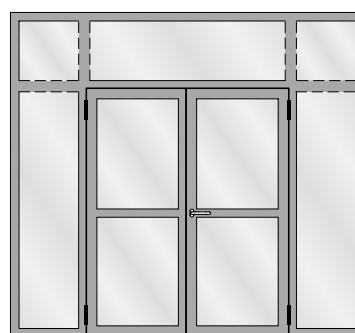

Zweiflügelige Türe mit zwei festen Seitenteilen
 und festen Oberlichtern
 Porte à deux vantaux avec deux parties latérales
 fixes et impostes fixes
 Double leaf door with two fixed side lights and
 fixed top lights

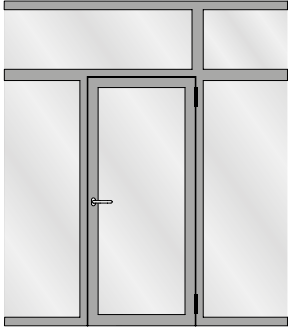

Festverglasung mit einflügeliger Türe
Vitrage fixe avec porte à un vantail
Fixed glazing with single leaf door

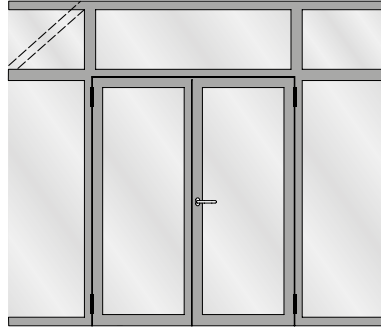

Festverglasung mit zweiflügeliger Türe
Vitrage fixe avec porte à deux vantaux
Fixed glazing with double leaf door



Festverglasung
Vitrage fixe
Fixed glazing

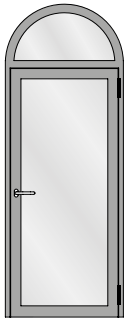

Einflügelige Türe mit Rundbogen-Oberlicht
Porte à un vantail avec imposte demi-ronde
Single leaf door with round arched top light

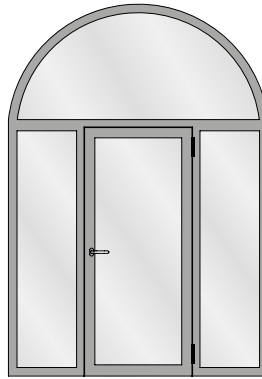

Einflügelige Türe mit zwei festen Seitenteilen
und Rundbogen-Oberlicht
Porte à un vantail avec deux parties latérales
fixes et imposte demi-ronde
Single leaf door with two fixed side lights and
round arched top light

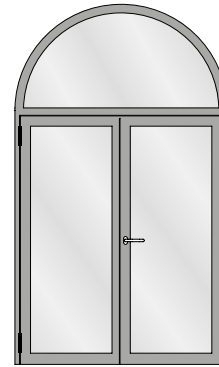

Zweiflügelige Türe mit Rundbogen-Oberlicht
Porte à deux vantaux avec imposte demi-ronde
Double leaf door with round arched top light

**Für Festverglasungen gelten
nationale Zulassungen.**

**Les homologations nationales
s'appliquent aux vitrages fixes.**

**National approvals apply to fixed
glazing.**

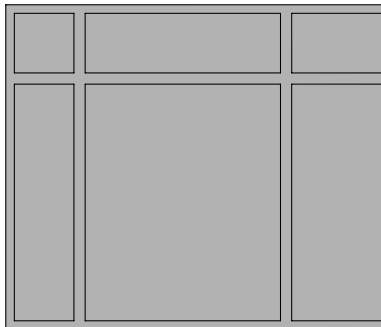
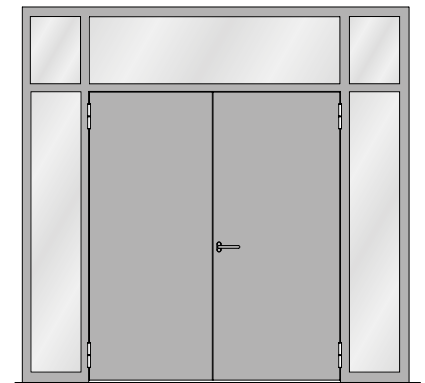
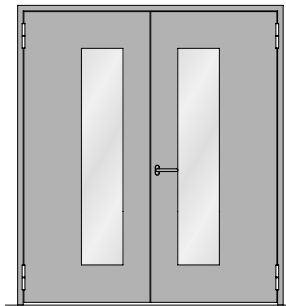
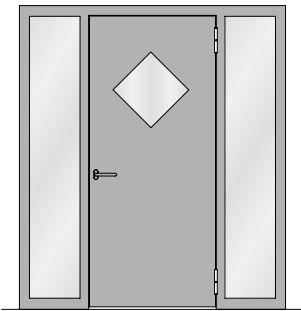
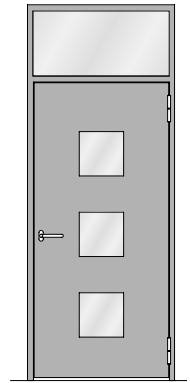
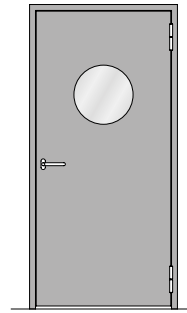
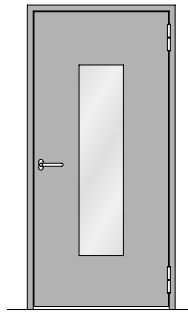
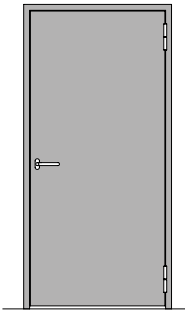

Für Festverglasungen gelten nationale Zulassungen.

Les homologations nationales s'appliquent aux vitrages fixes.

National approvals apply to fixed glazing.

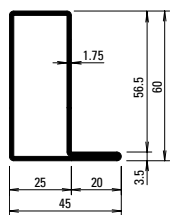

01.634
01.634 Z

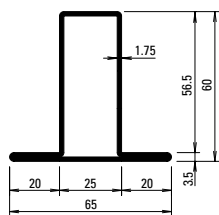

02.634
02.634 Z

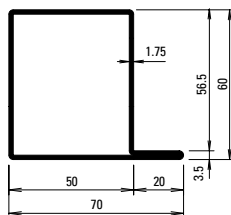

01.684
01.684 Z

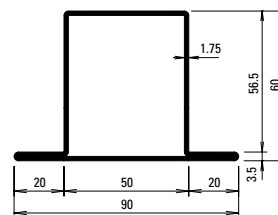

02.684
02.684 Z

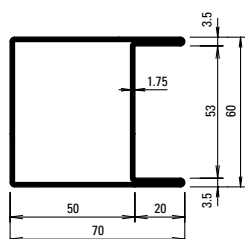

04.637
04.637 Z

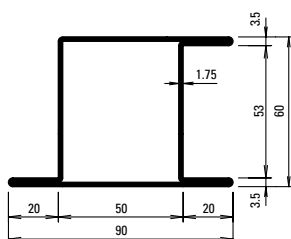

05.637
05.637 Z

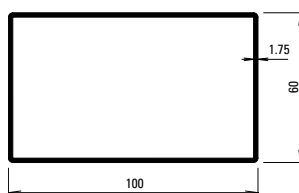

400.051
400.051 Z

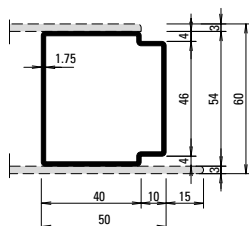

81.010 Z

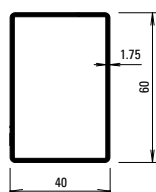

400.052
400.052 Z

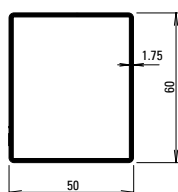

400.054
400.054 Z

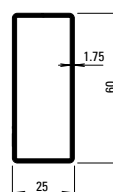

400.055
400.055 Z

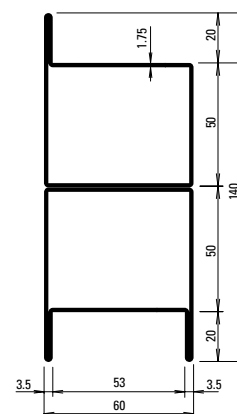

05.001

Profil-Nr.	G kg/m	F cm ²	I _x cm ⁴	W _x cm ³	I _y cm ⁴	W _y cm ³	U m ² /m
01.634	2,729	3,48	16,56	4,66	6,01	2,14	0,204
02.634	3,266	4,16	19,52	4,96	10,33	3,18	0,243
01.684	2,948	3,76	21,13	6,13	19,15	4,84	0,255
02.684	3,412	4,35	24,14	6,41	27,64	6,14	0,294
04.637	3,960	5,05	30,63	10,21	27,46	7,72	0,294
05.637	3,875	4,94	30,92	9,26	34,14	6,94	0,334
81.010	2,696	3,44	14,54	5,38	13,06	5,11	0,202
400.051	4,272	5,44	34,64	11,55	76,01	15,20	0,317
400.052	2,627	3,35	16,87	5,62	8,99	4,49	0,197
400.054	2,901	3,70	19,84	6,61	14,97	5,99	0,217
400.055	2,214	2,82	12,41	4,14	3,09	2,47	0,167

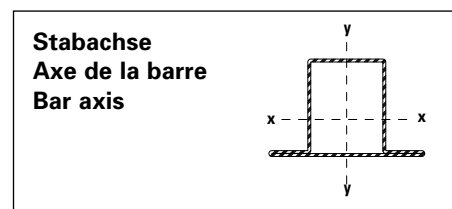

Artikelbibliothek
 Bibliothèque des articles
 Article library

DXF **DWG**

Bogentüren
Portes cintrées
Arched doors

Jansen-Economy 60 RS
 Jansen-Economy 60 RS
 Jansen-Economy 60 RS

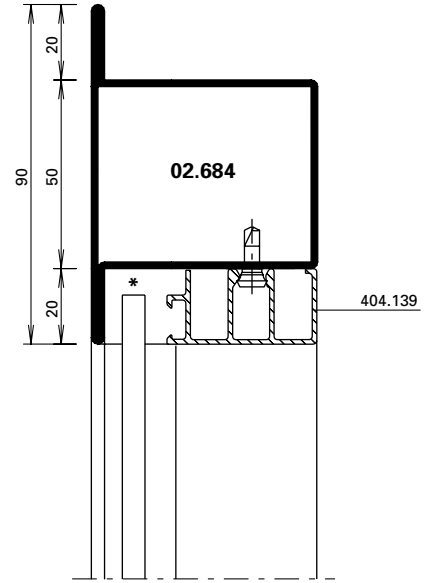
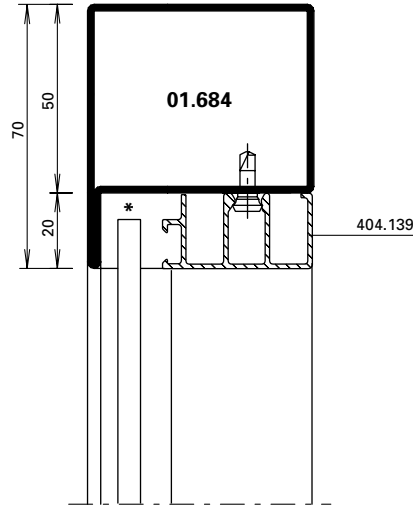
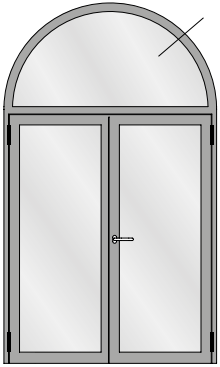

* Füllelemente mit rauchdichtem dauerelastischem Dichtstoff (z.B. 450.092) vollständig in den Glasfalzgrund einkleben.

* Coller entièrement les éléments de remplissage avec produit d'étanchéité à l'élasticité permanente (p.ex. 450.092) dans la feuillure en verre.

* Infill panels with smoke-tight, permanently flexible sealant (e.g. 450.092) fully glued into the glazing rebate platform.

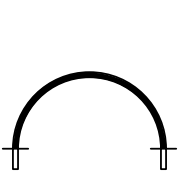

Halbrundbogen
 Arc semi-circulaire
 Semi-circular arch

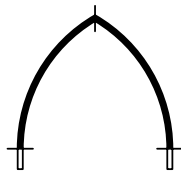

Spitzbogen
 Arc en ogive
 Gothic arch



Stichbogen
 Arc bombé
 Segmented arch



Korbbogen
 Anse de panier
 Oval arch

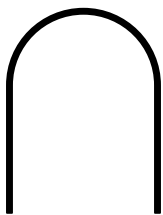

Halbrundbogen mit Schenkel
 Arc surhaussé prolongée
 Semi-circular arch with side extension

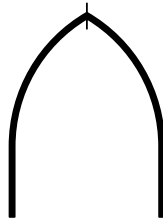

Spitzbogen mit Schenkel
 Arc en ogive prolongée
 Gothic arch with side extension

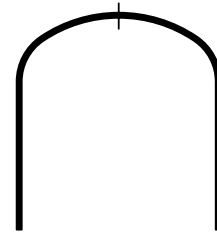



Korbbogen mit Schenkel
 Anse de panier prolongée
 Oval arch with side extension

Bogentüren
Portes cintrées
Arched doors

Jansen-Economy 60 RS
 Jansen-Economy 60 RS
 Jansen-Economy 60 RS

Profil Profilé Profile	Min. Radius Rayon min. Min. radius R	blank brut bright	verzinkt zinguée galvanised
		mm	mm
01.634		550	550
01.684		650	650

		mm	mm
02.634		600	650
02.684		1050	1050

		mm	mm
04.637		1550	1550

		mm	mm
05.637		1550	1550

		mm	mm
400.052		1100	1100
400.054		1000	1000
400.055		800	800
81.010			800

Profil Profilé Profile	Min. Radius Rayon min. Min. radius R	blank brut bright	verzinkt zinguée galvanised
		mm	mm
30.018			550
30.019		650	650

		mm	mm
30.118		800	800
30.119		900	900

		mm	mm
30.418		800	800
30.419		1100	1100

Stahl-Glasleisten Parcloses en acier Steel glazing beads	Min. Radius Rayon min. Min. radius R
--	---

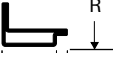
		mm
62.507 Z		300 mm
62.508 Z		300 mm
62.509 Z		300 mm

Stahl-Glasleisten Parcloses en acier Steel glazing beads	Min. Radius Rayon min. Min. radius R	
		mm
402.112 Z		500 mm
402.115 Z		500 mm
402.120 Z		600 mm
402.125 Z		750 mm
402.130 Z		1000 mm
402.135 Z		1500 mm

Aluminium-Glasleisten Parcloses en aluminium Aluminium glazing beads	Min. Radius Rayon min. Min. radius R
--	---

		mm
404.109		400 mm
404.112		400 mm
404.115		400 mm
404.120		400 mm
404.125		450 mm
404.130		500 mm
404.135		600 mm

		mm
405.110		500 mm
405.115		500 mm
405.120		500 mm
405.125		800 mm
405.130		1000 mm
406.903		500 mm
406.905		500 mm
406.907		500 mm
406.909		600 mm

Die Radien-Angaben beziehen sich auf die langjährige Erfahrung und Fertigung im Hause Jansen.

Les rayons indiqués se fondent sur la longue expérience et la fabrication au sein de la maison Jansen.

The radii specifications are based on the many years of experience Jansen has in fabrication.

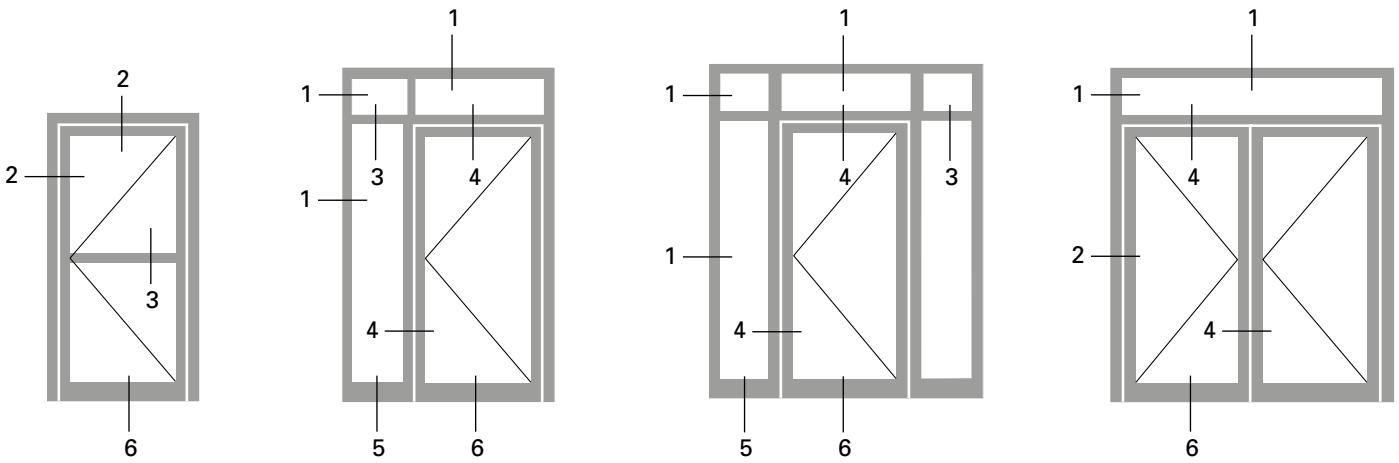

3.0

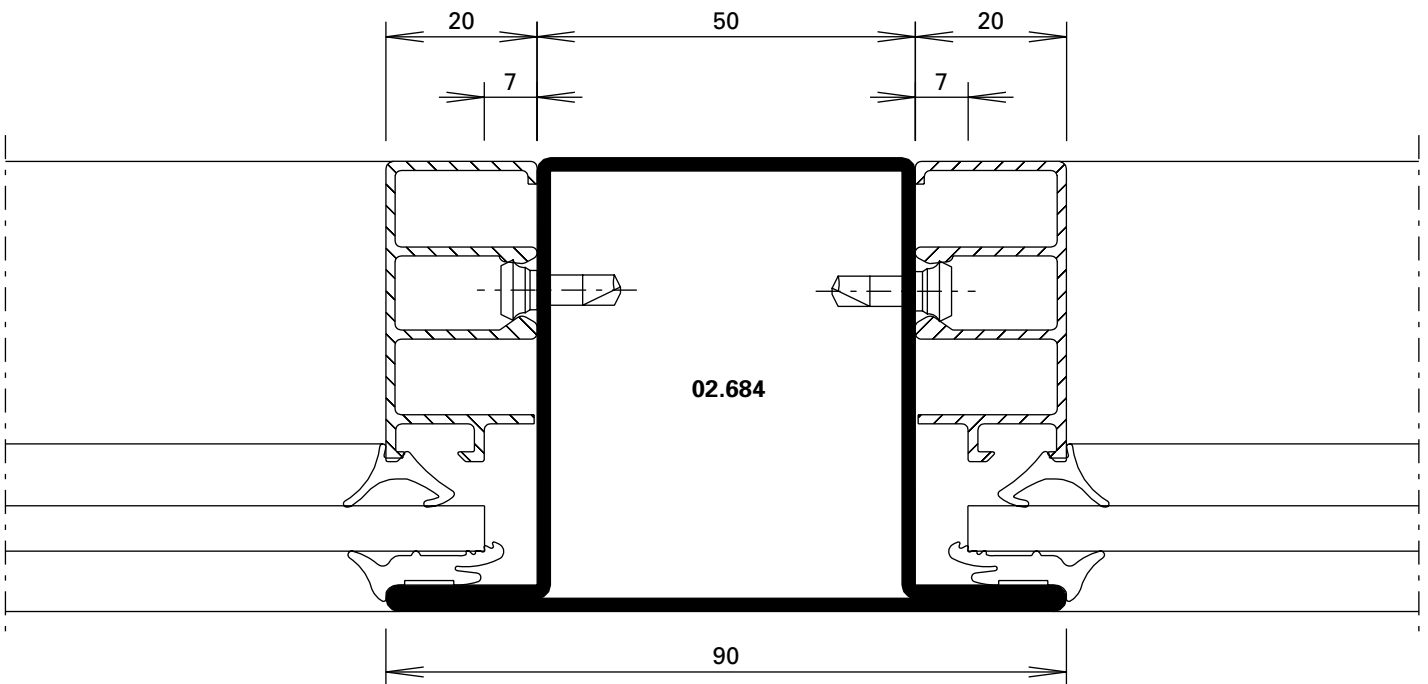

DXF DWG 41-0301-C-007

2.0

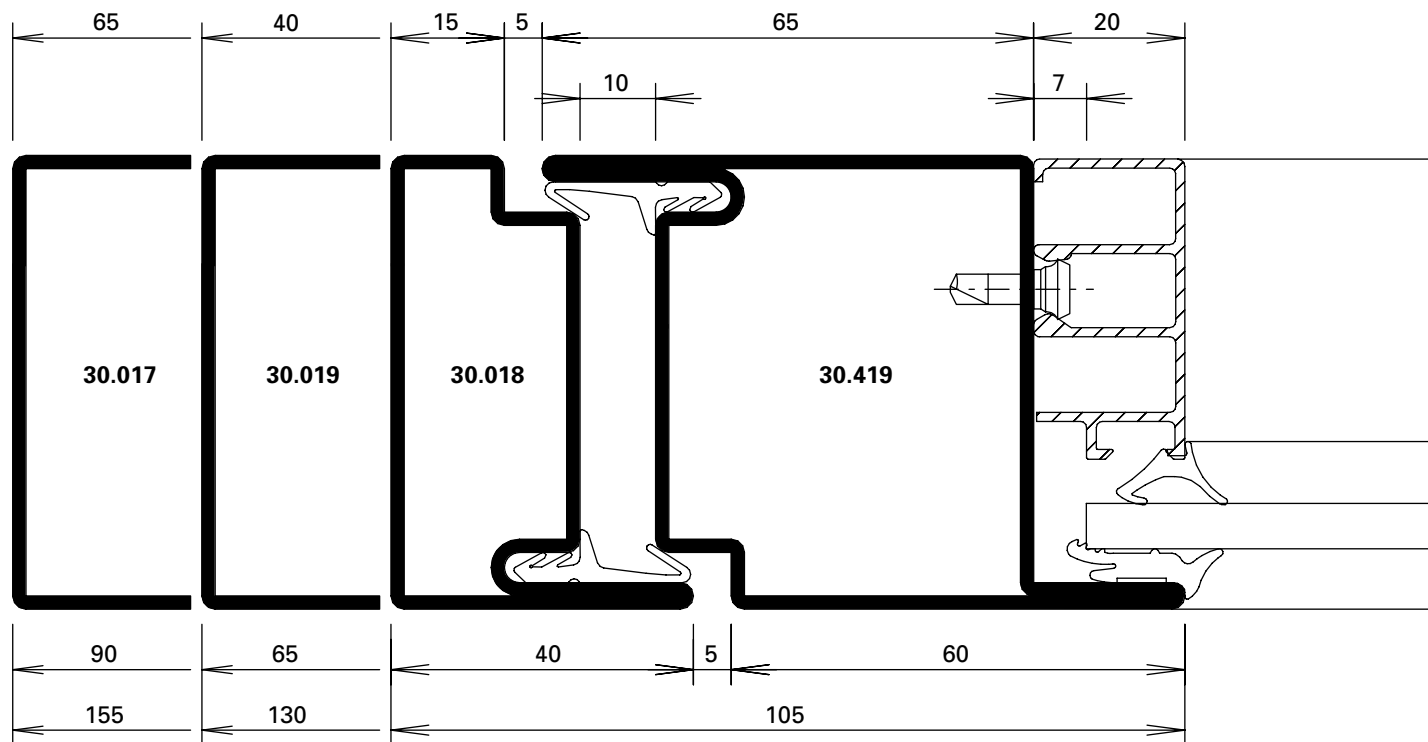

DXF **DWG** 41-0301-C-004

4.0

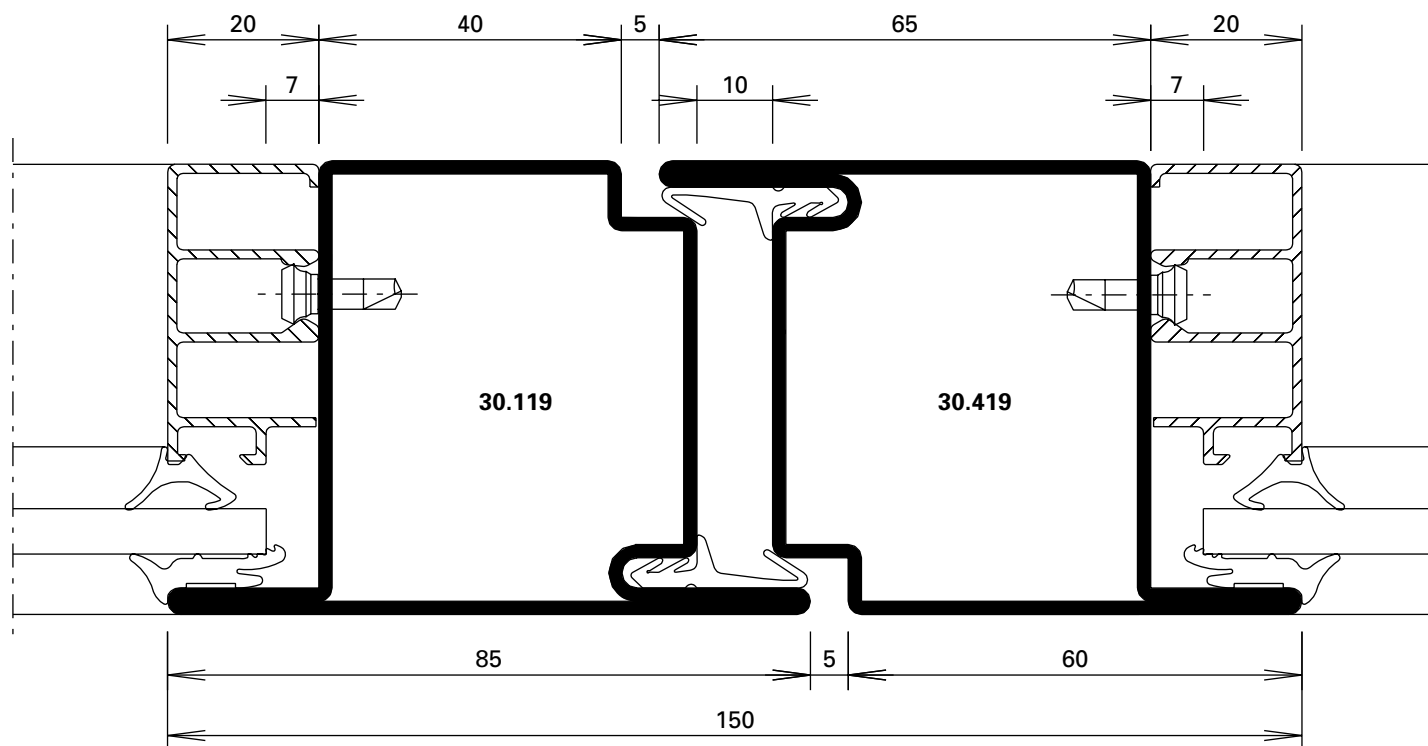

DXF **DWG** 41-0301-C-008

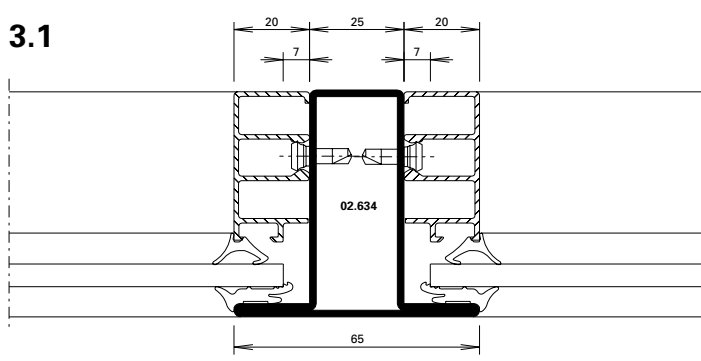
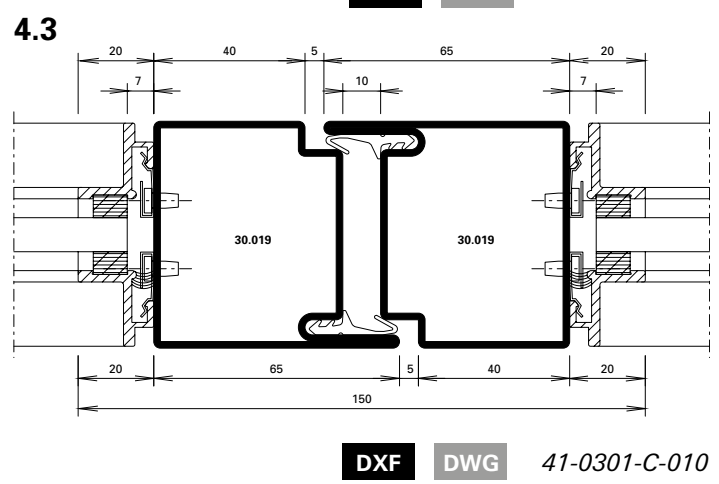
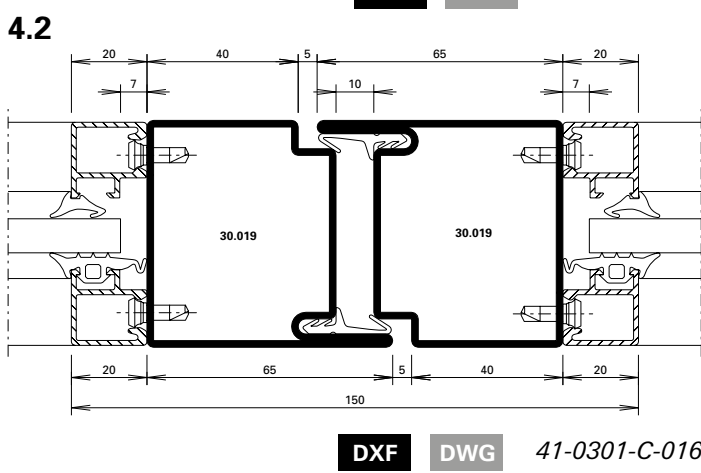
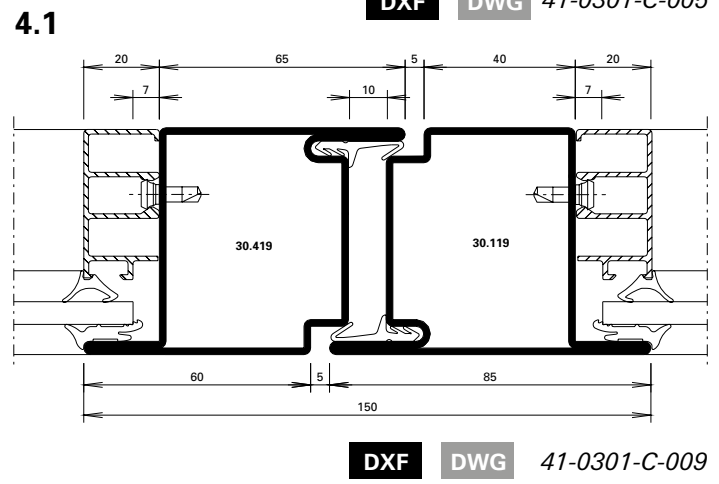
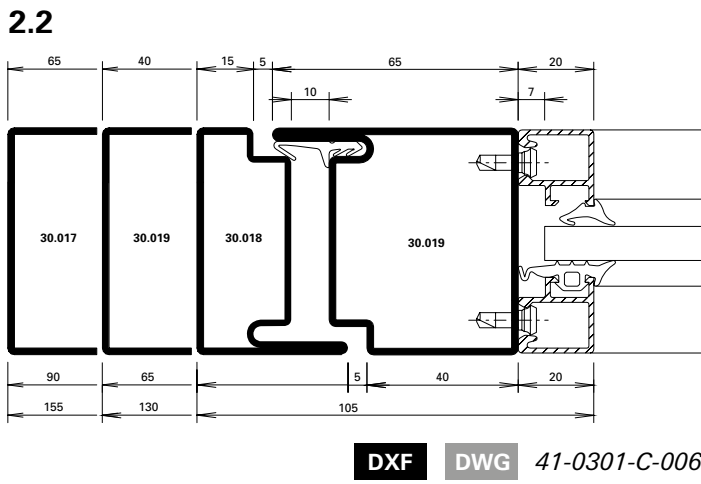
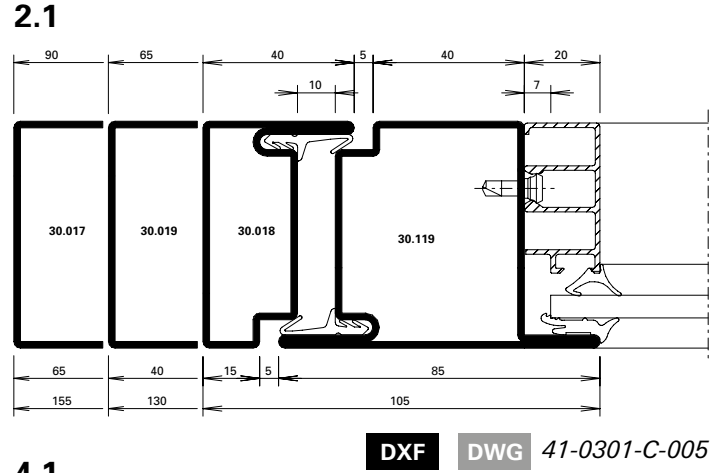
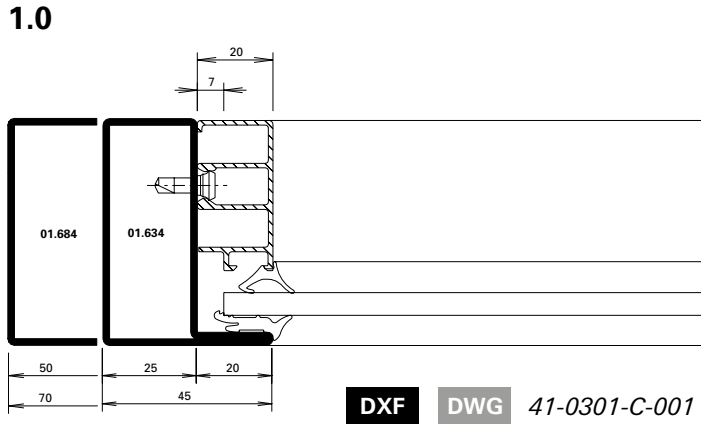

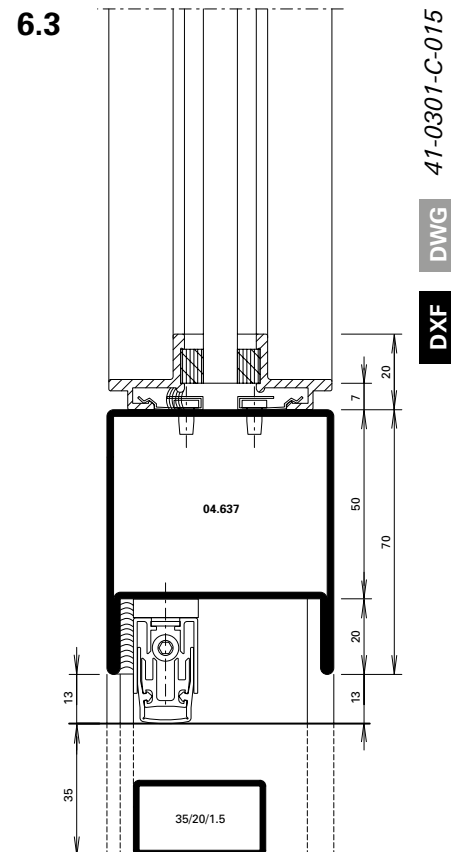
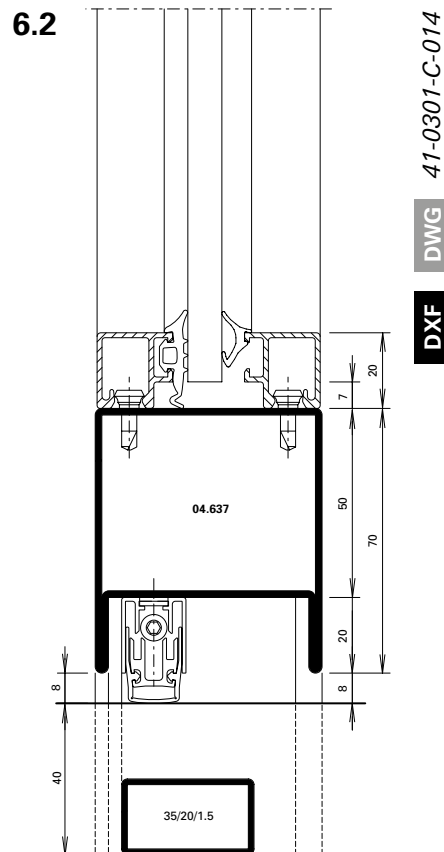
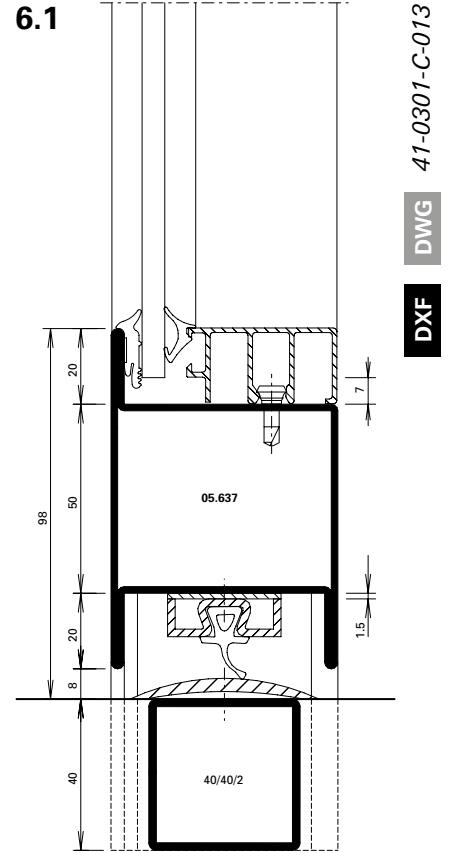
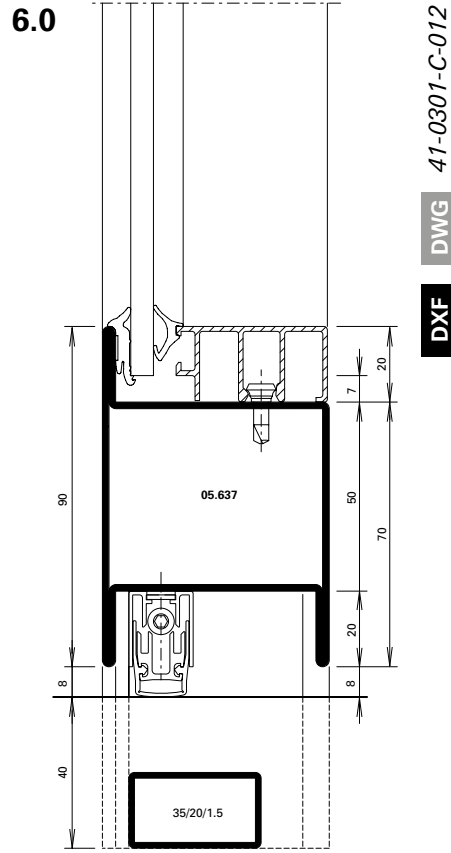
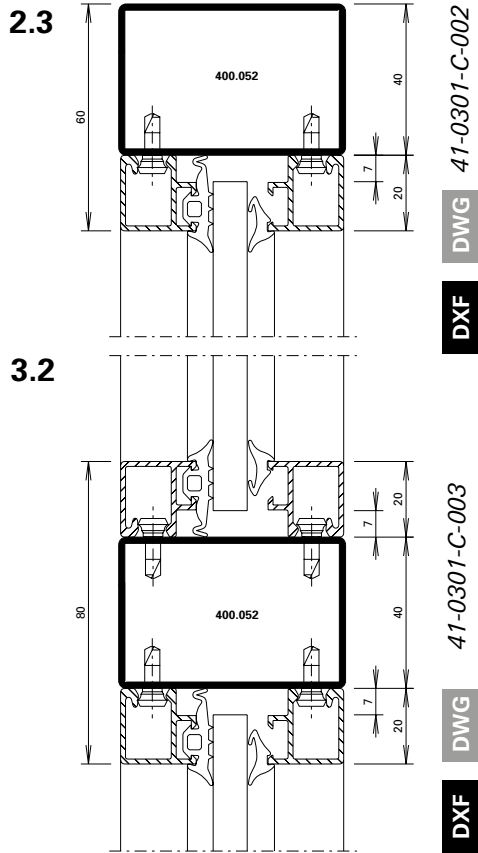

Glasleisten-Varianten im Masstab 1:2
Variantes de parcloses à l'échelle 1:2
Glazing bead options on scale 1:2

Jansen-Economy 60 RS
 Jansen-Economy 60 RS
 Jansen-Economy 60 RS

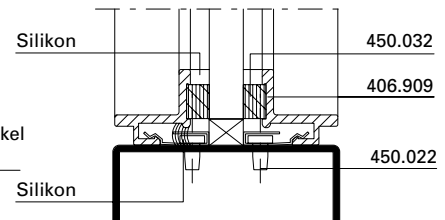
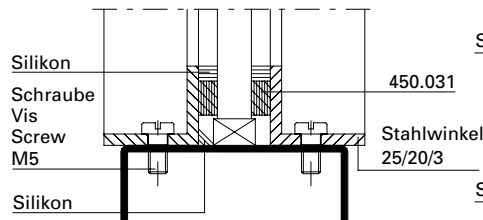
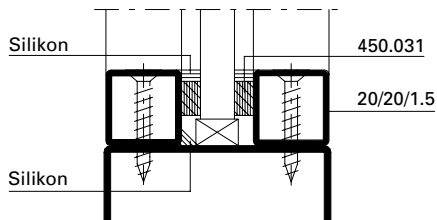
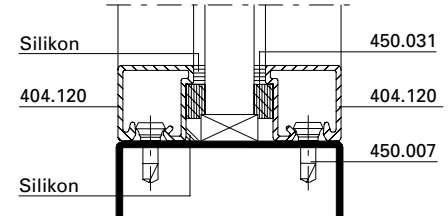
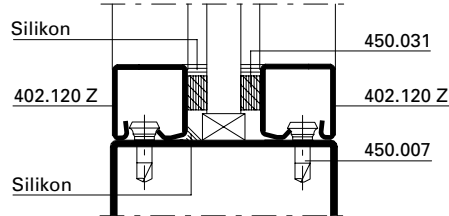
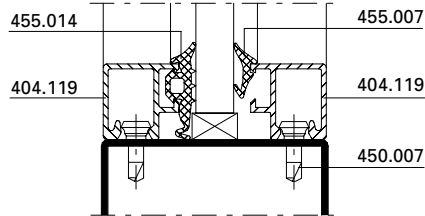
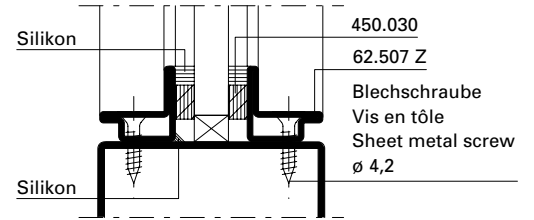
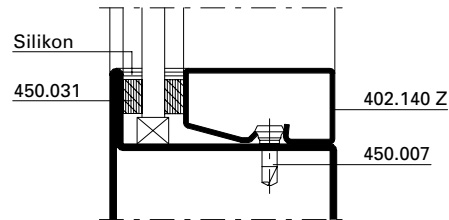
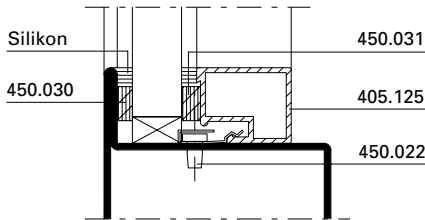
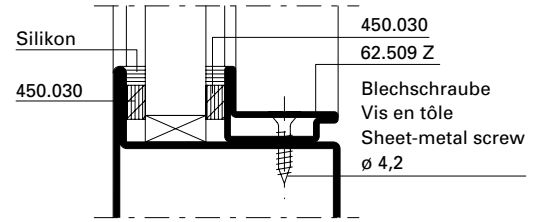
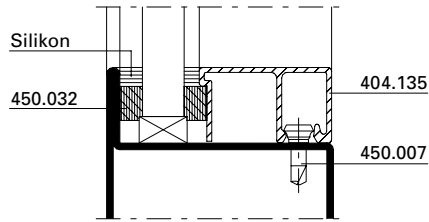
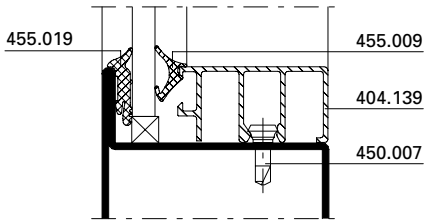

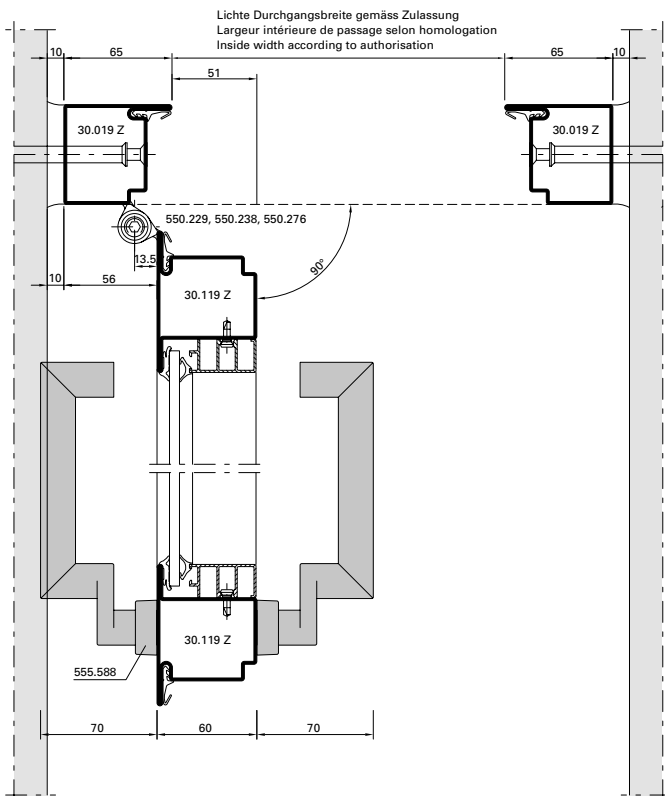

DXF DWG 41-0301-E-013

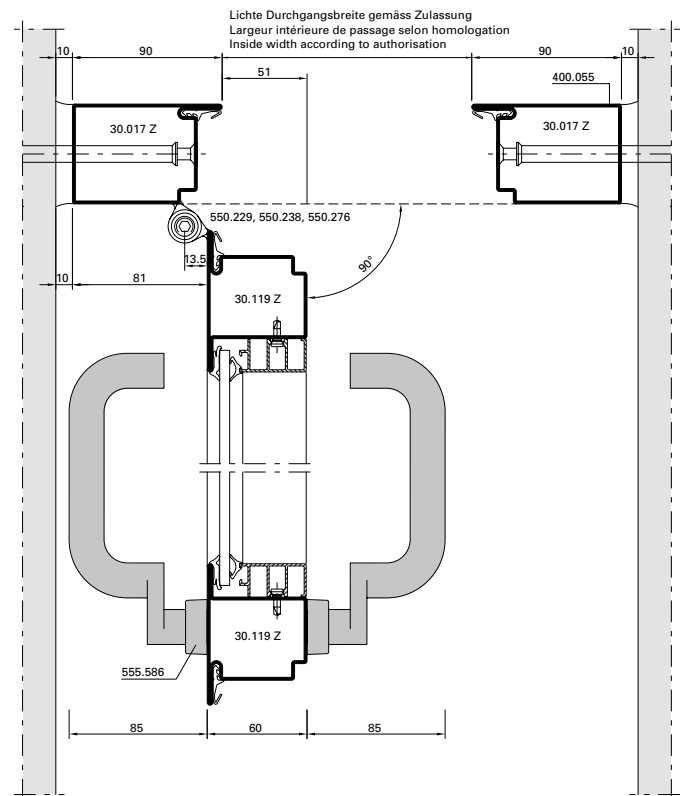

DXF DWG 41-0301-E-014

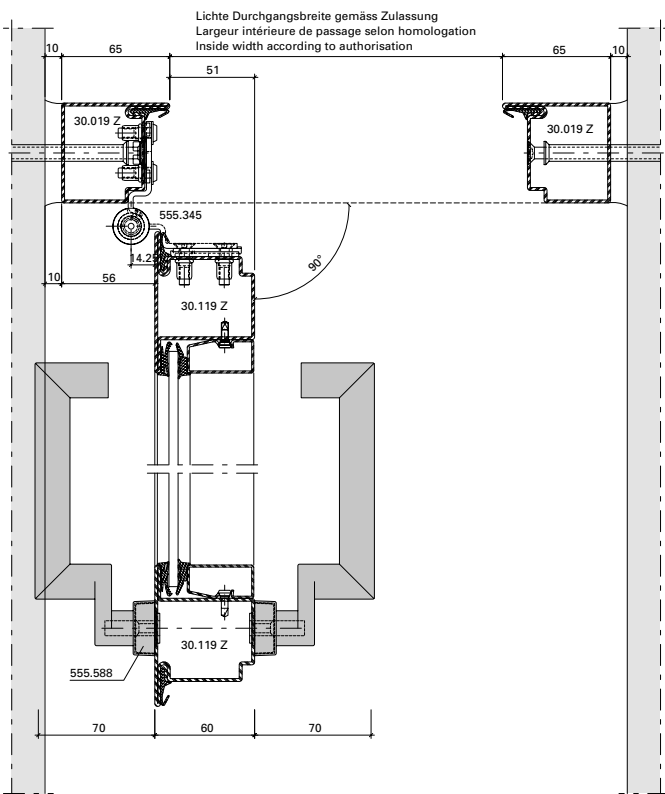

DXF DWG 41-0301-E-015

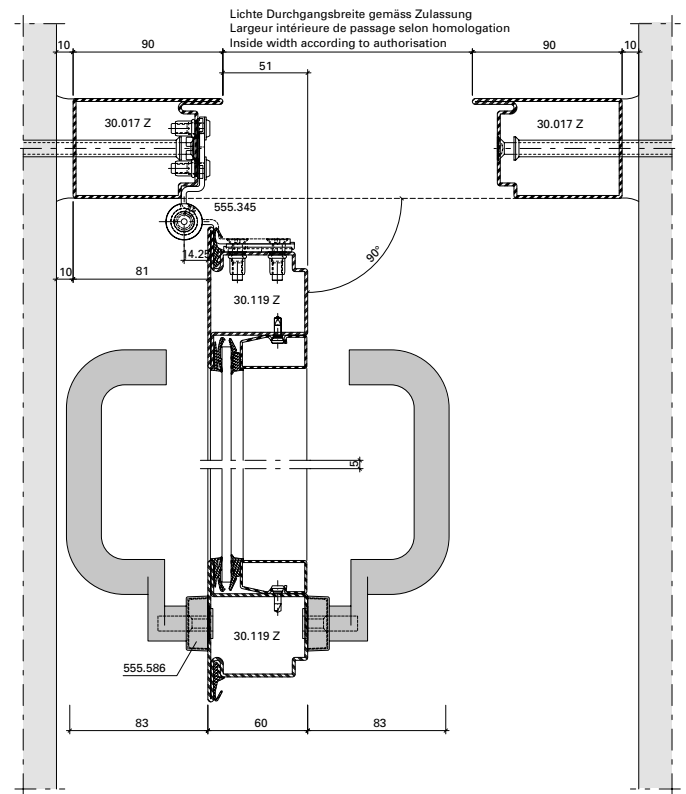

DXF DWG 41-0301-E-016

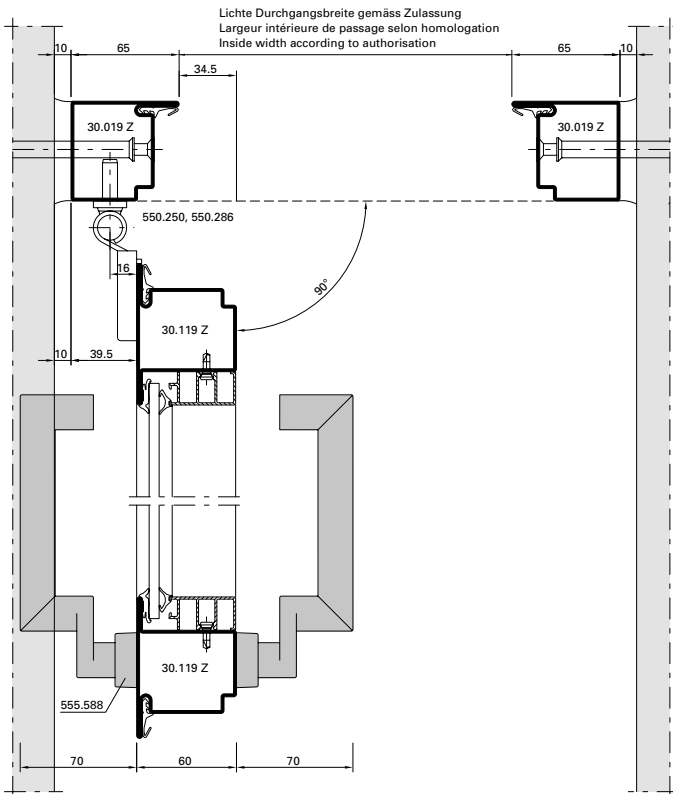

DXF **DWG** 41-0301-E-017

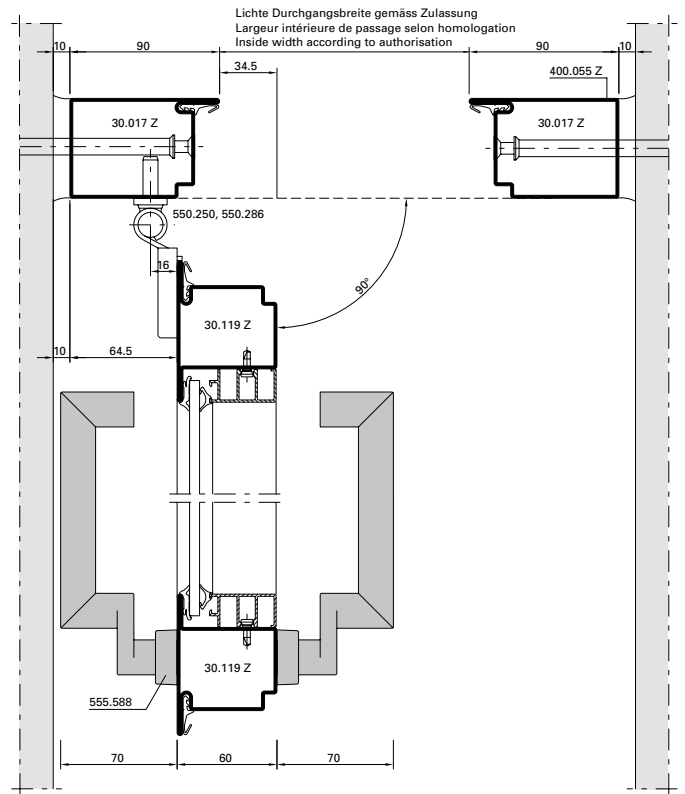

DXF **DWG** 41-0301-E-018

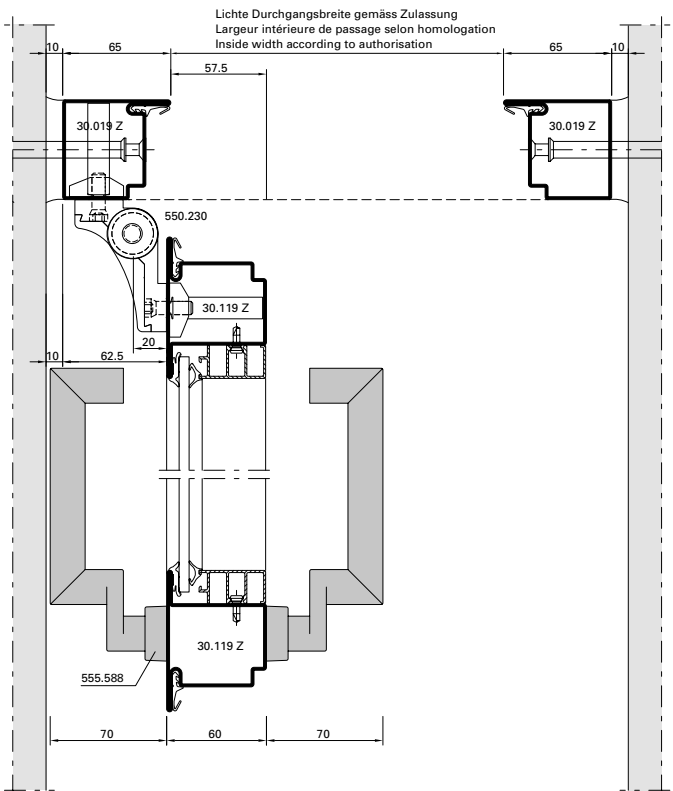

DXF **DWG** 41-0301-E-019

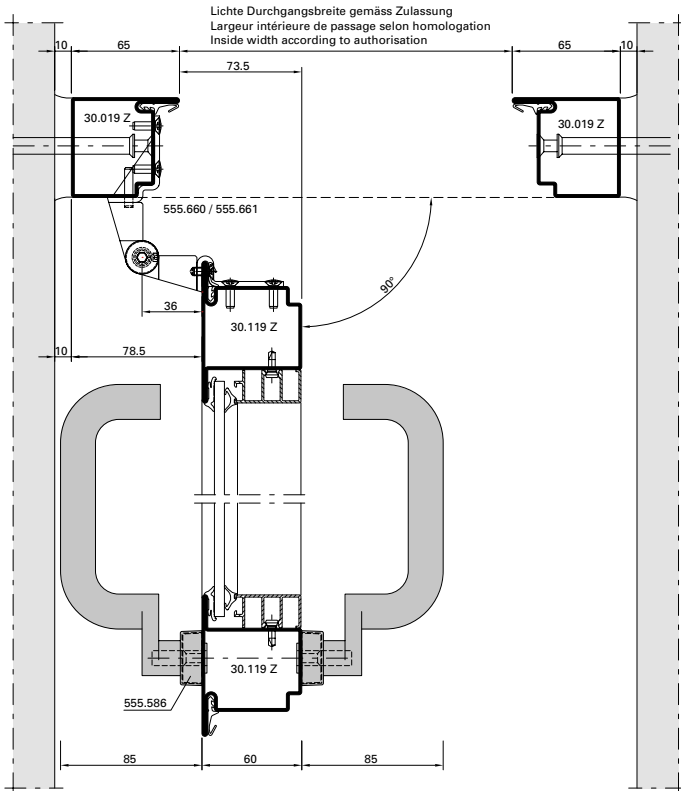

DXF **DWG** 41-0301-E-023

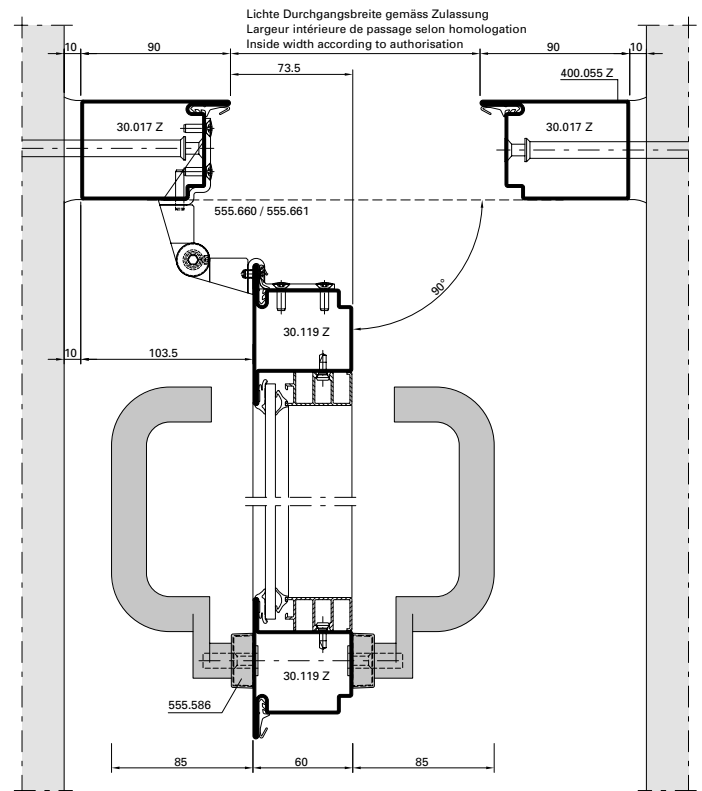

DXF **DWG** 41-0301-E-022

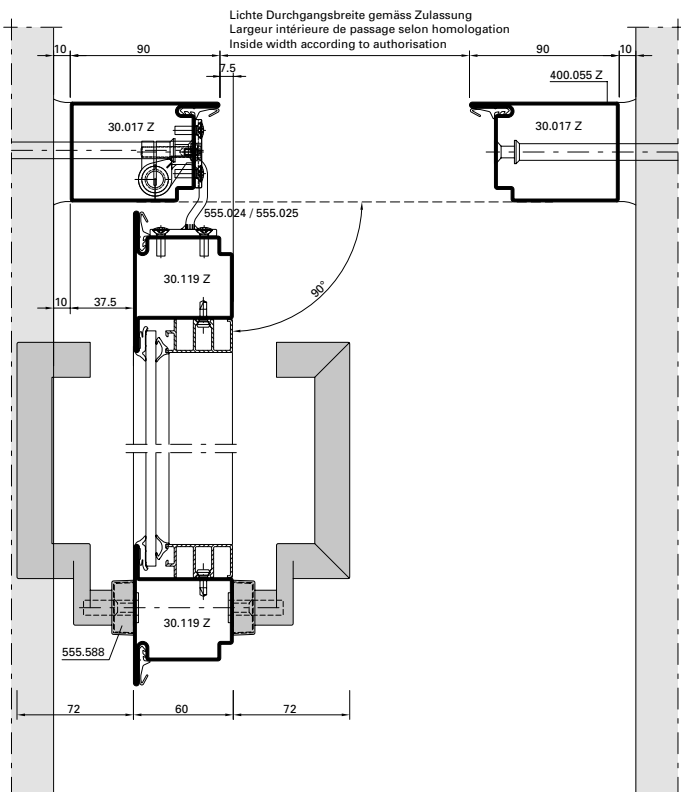

DXF **DWG** 41-0301-E-021

Anschlüsse am Bau im Massstab 1:2
Raccords au mur à l'échelle 1:2
Attachment to structure on scale 1:2

Jansen-Economy 60 RS
Jansen-Economy 60 RS
Jansen-Economy 60 RS

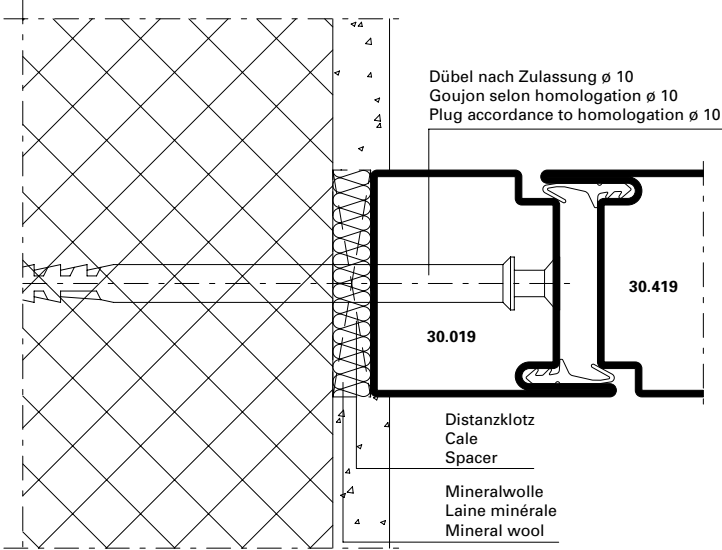

DXF DWG 41-0301-A-014

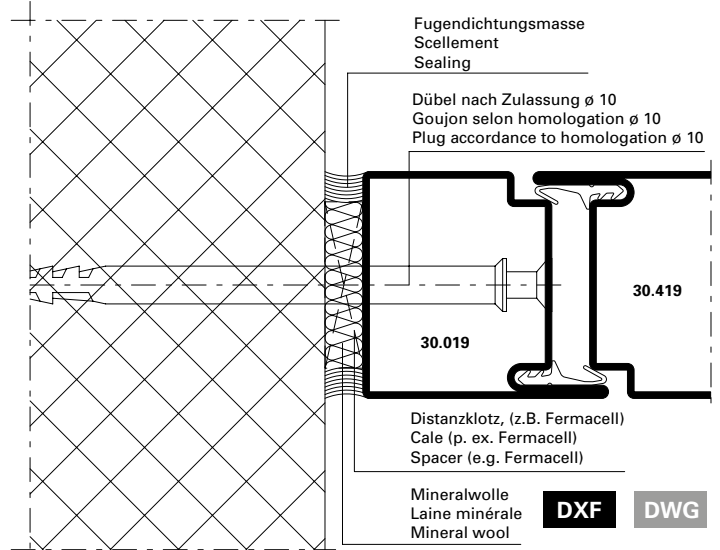

DXF DWG 41-0301-A-015

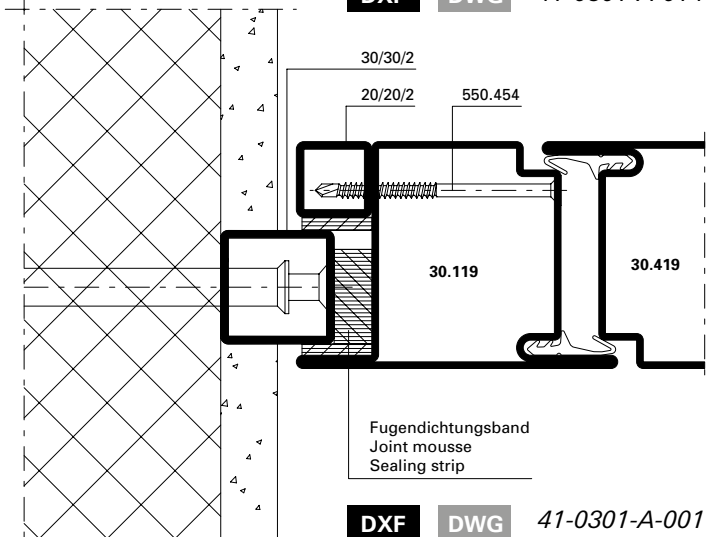

DXF DWG 41-0301-A-001

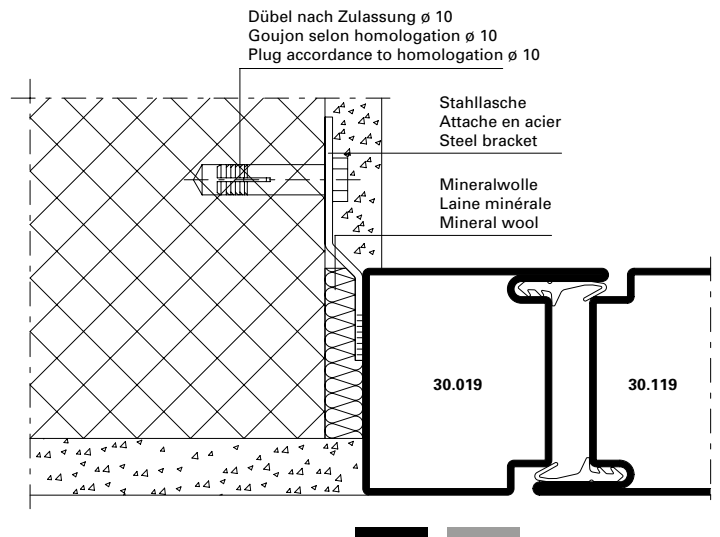

DXF DWG 41-0301-A-002

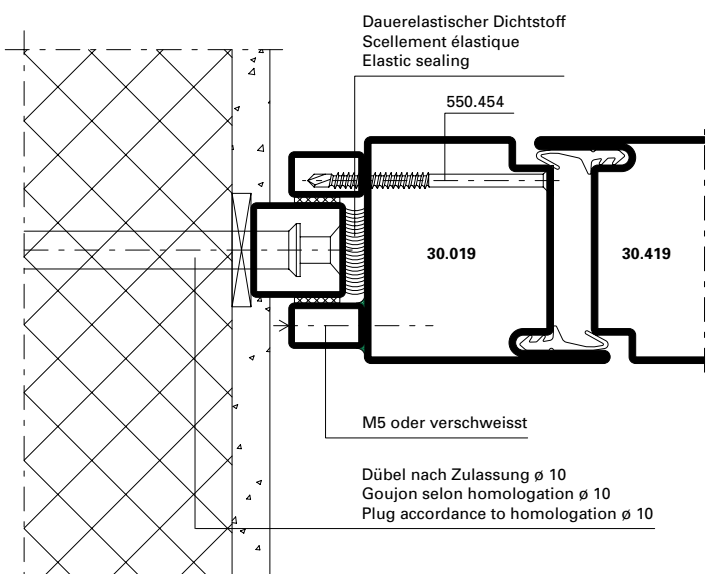

DXF DWG 41-0301-A-003

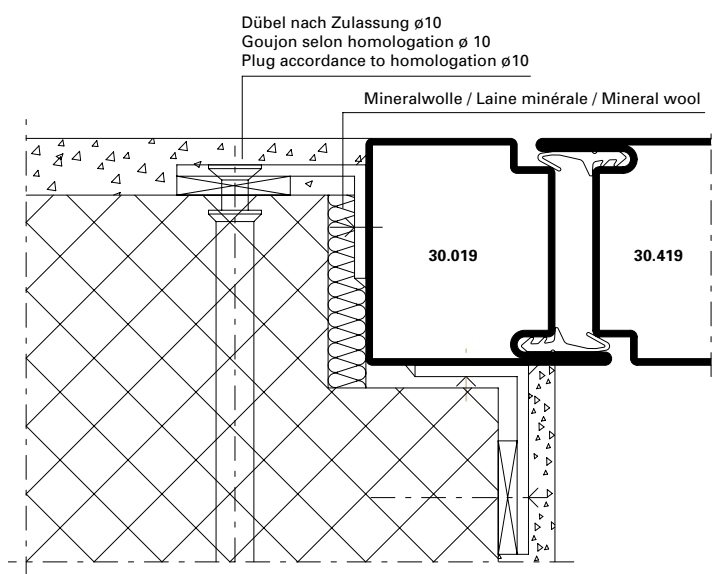

DXF DWG 41-0301-A-016

Anschlüsse am Bau im Masstab 1:2
Raccords au mur à l'échelle 1:2
Attachment to structure on scale 1:2

Jansen-Economy 60 RS
 Jansen-Economy 60 RS
 Jansen-Economy 60 RS

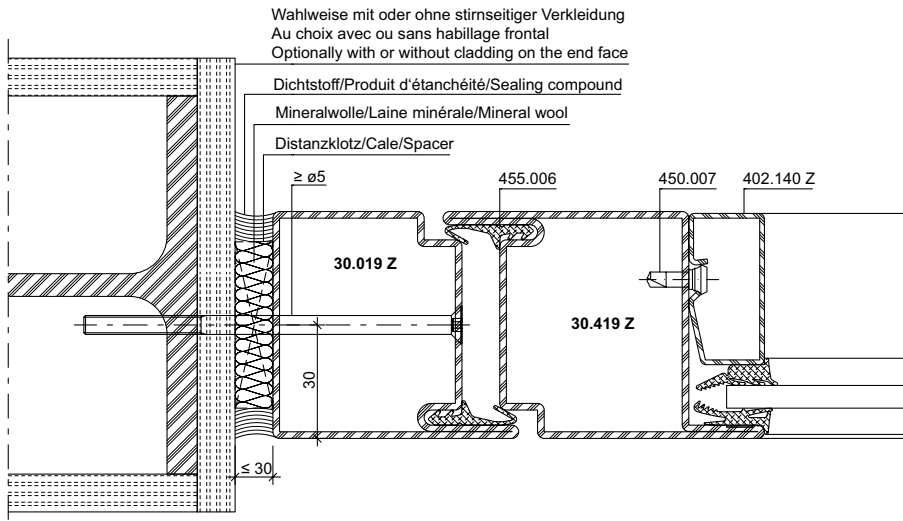

DXF **DWG** 41-0301-A-004

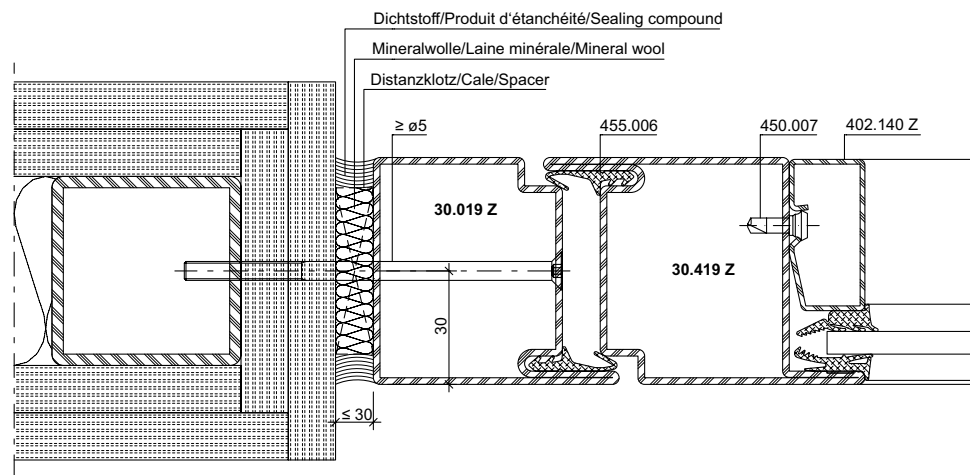

DXF **DWG** 41-0301-A-006

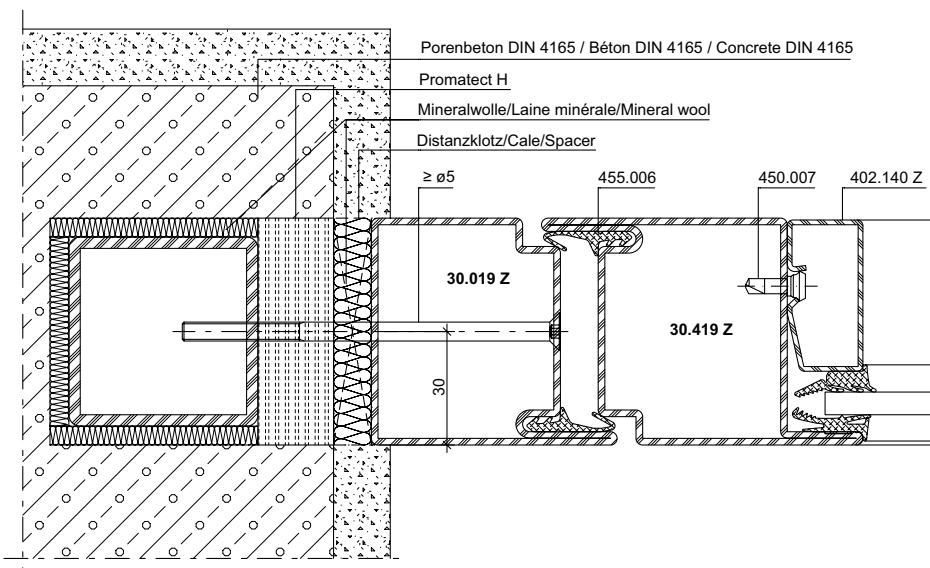

DXF **DWG** 41-0301-A-008

Anschlüsse am Bau im Massstab 1:2

Raccords au mur à l'échelle 1:2

Attachment to structure on scale 1:2

Jansen-Economy 60 RS

Jansen-Economy 60 RS

Jansen-Economy 60 RS

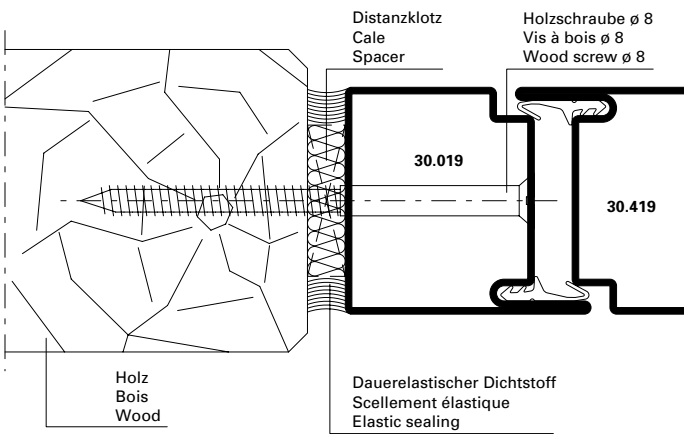

DXF **DWG** 41-0301-A-005

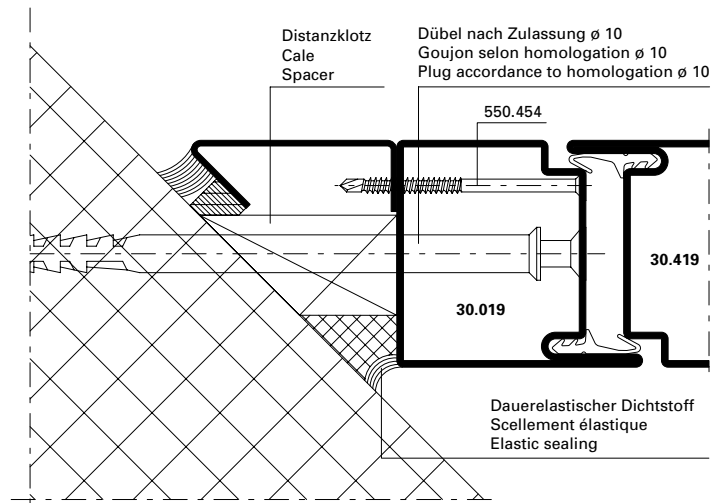

DXF **DWG** 41-0301-A-007

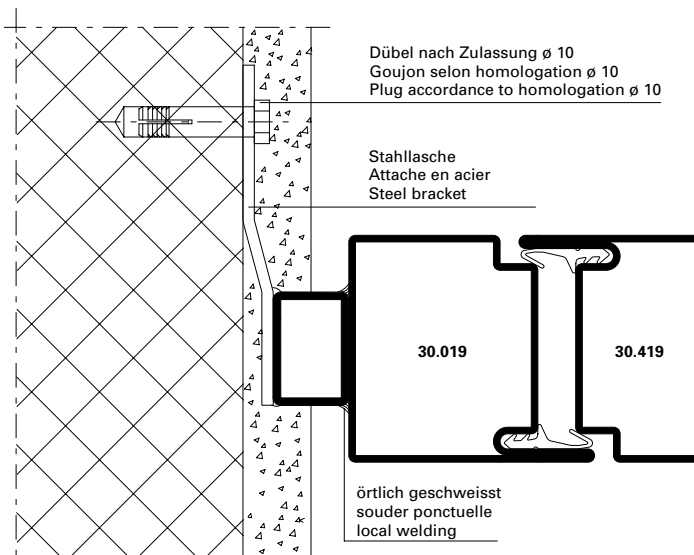

DXF **DWG** 41-0301-A-009

41-0301-A-011

DXF **DWG**

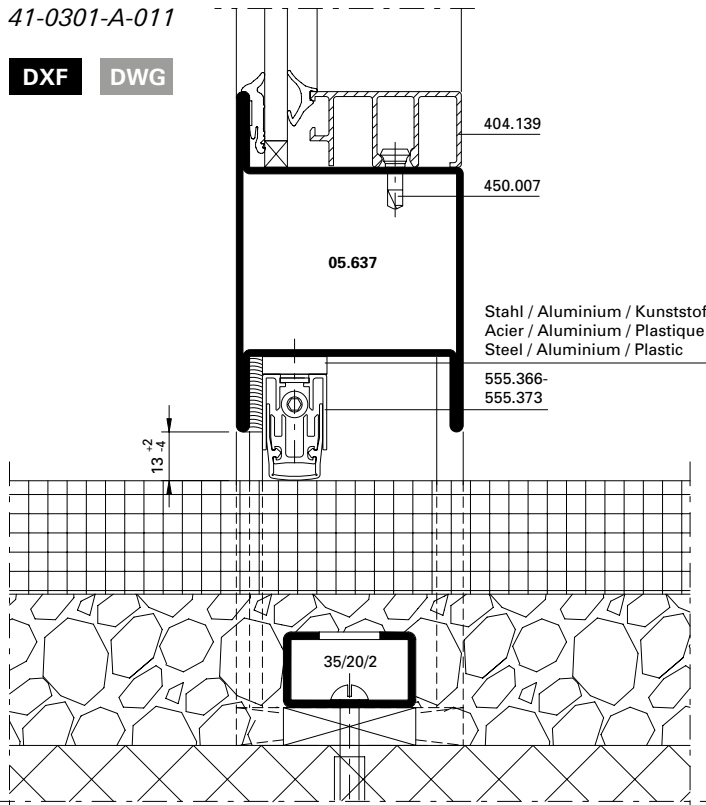

41-0301-A-013

DXF **DWG**

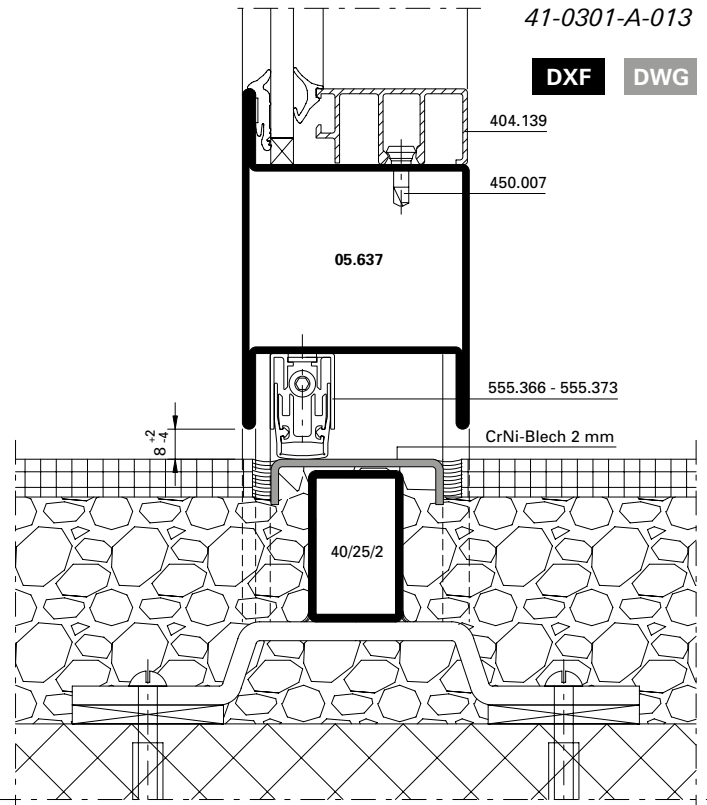

41-0301-A-010

DXF **DWG**

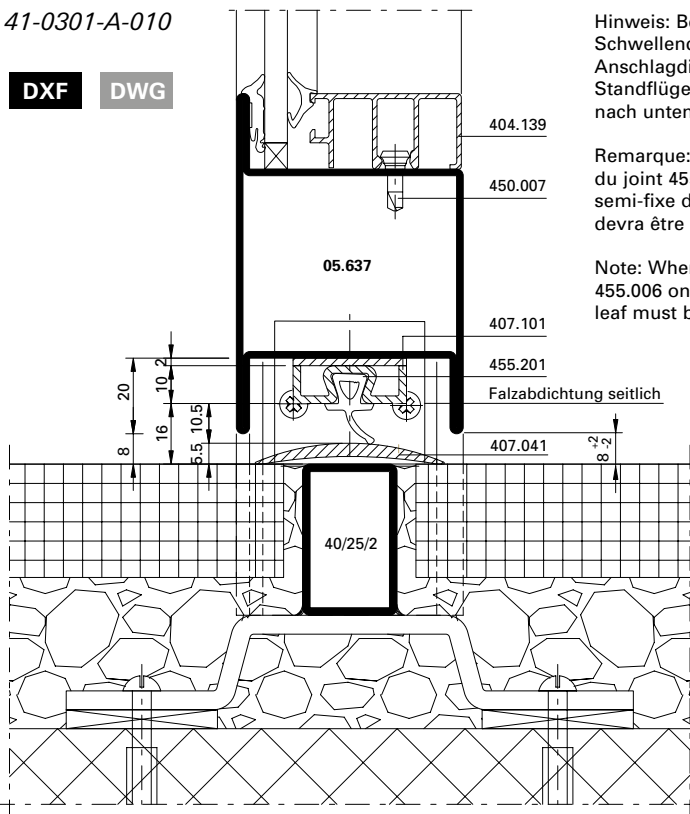

Hinweis: Bei Verwendung der Schwelldichtung 455.201 oder Anschlagdichtung 455.006 muss der Standflügel von zweiflügeligen Türen nach unten verriegelt werden.

Remarque: Dans le cas de l'utilisation du joint 455.201 ou 455.006, le vantail semi-fixe des portes à deux vantaux devra être verrouillé aussi en bas.

Note: When using gasket 455.201 or 455.006 on two leaf doors the fixed leaf must be locked towards the bottom.

41-0301-A-012

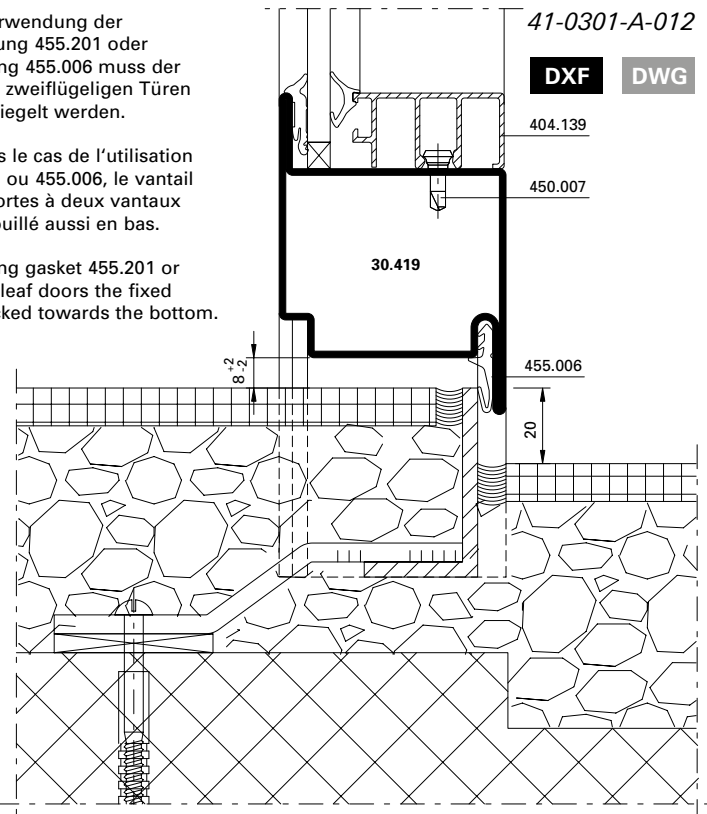

DXF **DWG**



Einflügelige Türen,
 auswärts öffnend,
 Flügelhöhe ≤ 2200 mm

Porte à un vantail,
 ouvrant vers l'extérieur,
 hauteur du vantail ≤ 2200 mm

Single leaf door,
 outward opening,
 leaf height ≤ 2200 mm

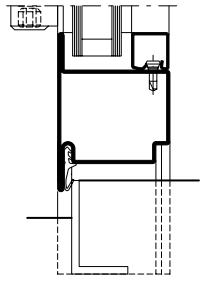
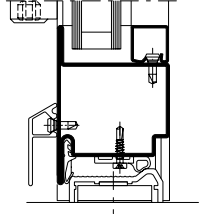
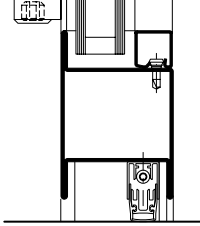
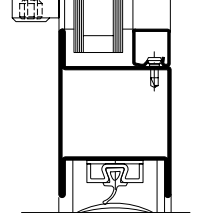
Variante	Beschlag Ferrure Fitting	 EN 12207	 EN 12208	 EN 12210
Anschlagdichtung Joint de butée Rebate gasket 	1	2	1A	C4
	2	2	2A	C4
	3	3	2A	C5
Doppel-Anschlagdichtung Joint de base double Double rebate gasket 	1	4	3A	C4
	2	4	3A	C4
	3	4	5A	C5
Senkdichtung Joint seuil Drop seal 	1	2	1A	C4
	2	2	2A	C4
	3	3	2A	C5
Auflaufdichtung Joint de contact Ramp seal 	1	2	0	C4
	2	2	0	C4
	3	2	0	C5

1 Fallenriegel-Schloss
 Serrure à mortaiser
 Latch and bolt lock





2 Schloss mit Obenverriegelung
 Serrure avec verrouillage supérieur
 Lock with top locking point

3 Mehrfachverriegelungs-Schloss
 Serrure à verrouillage multiple
 Multipoint lock

Einflügelige Türen,
 einwärts öffnend,
 Flügelhöhe ≤ 2200 mm

Porte à un vantail,
 ouvrant vers l'intérieur,
 hauteur du vantail ≤ 2200 mm

Single leaf door,
 inward opening,
 leaf height ≤ 2200 mm

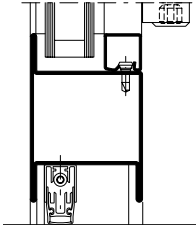
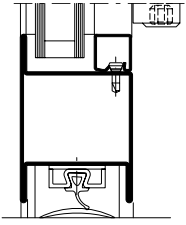
Variante		Beschlag Ferrure Fitting	 EN 12207	 EN 12208	 EN 12210
Senkdichtung Joint seuil Drop seal		❶	2	0	C4
		❷	2	0	C4
		❸	3	1A	C5
Auflaufdichtung Joint de contact Ramp seal		❶	2	0	C4
		❷	2	0	C4
		❸	2	0	C5

❶ Fallenriegel-Schloss
 Serrure à mortaiser
 Latch and bolt lock



❷ Schloss mit Obenverriegelung
 Serrure avec verrouillage supérieur
 Lock with top locking point

❸ Mehrfachverriegelungs-Schloss
 Serrure à verrouillage multiple
 Multipoint lock

Einflügelige Türen,
 auswärts öffnend,
 Flügelhöhe ≤ 3000 mm

Porte à un vantail,
 ouvrant vers l'extérieur,
 hauteur du vantail ≤ 3000 mm

Single leaf door,
 outward opening,
 leaf height ≤ 3000 mm

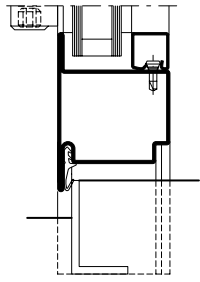
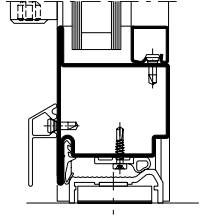
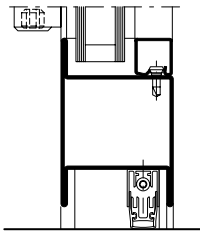
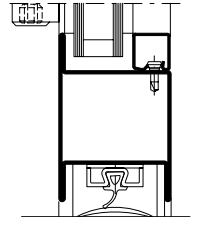
Variante	Beschlag Ferrure Fitting	 EN 12207	 EN 12208	 EN 12210
Anschlagdichtung Joint de butée Rebate gasket 	1	1	0	C1
	2	1	0	C1
	3	1	0	C2
Doppel-Anschlagdichtung Joint de base double Double rebate gasket 	1	1	1A	C1
	2	1	1A	C1
	3	2	2A	C2
Senkdichtung Joint seuil Drop seal 	1	1	0	C1
	2	1	0	C1
	3	1	0	C2
Aufleumdichtung Joint de contact Ramp seal 	1	0	0	C1
	2	0	0	C1
	3	1	0	C2

1 Fallenriegel-Schloss
 Serrure à mortaiser
 Latch and bolt lock





2 Schloss mit Obenverriegelung
 Serrure avec verrouillage supérieur
 Lock with top locking point

3 Mehrfachverriegelungs-Schloss
 Serrure à verrouillage multiple
 Multipoint lock

Einflügelige Türen,
 einwärts öffnend,
 Flügelhöhe ≤ 3000 mm

Porte à un vantail,
 ouvrant vers l'intérieur,
 hauteur du vantail ≤ 3000 mm

Single leaf door,
 inward opening,
 leaf height ≤ 3000 mm

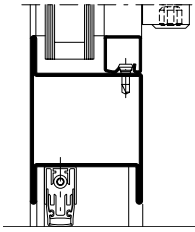
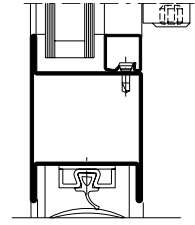
Variante		Beschlag Ferrure Fitting	 EN 12207	 EN 12208	 EN 12210
Senkdichtung Joint seuil Drop seal		❶	1	0	C1
		❷	1	0	C1
		❸	1	0	C2
Auflaufdichtung Joint de contact Ramp seal		❶	0	0	C1
		❷	0	0	C1
		❸	1	0	C2

❶ Fallenriegel-Schloss
 Serrure à mortaiser
 Latch and bolt lock



❷ Schloss mit Obenverriegelung
 Serrure avec verrouillage supérieur
 Lock with top locking point

❸ Mehrfachverriegelungs-Schloss
 Serrure à verrouillage multiple
 Multipoint lock

Zweiflügelige Türen,
 auswärts öffnend,
 Flügelhöhe ≤ 2200 mm

Porte à deux vantaux,
 ouvrant vers l'extérieur,
 hauteur du vantail ≤ 2200 mm

Double leaf door,
 outward opening,
 leaf height ≤ 2200 mm

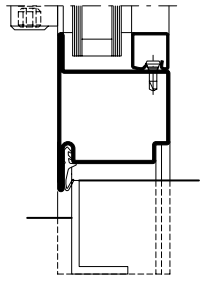
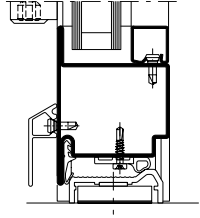
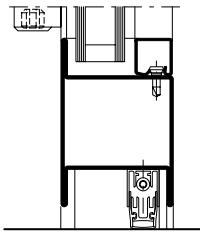
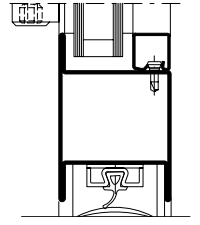
Variante	Beschlag Ferrure Fitting	 EN 12207	 EN 12208	 EN 12210
Anschlagdichtung Joint de butée Rebate gasket 	1	2	1A	C2
	2	2	2A	C2
	3	2	2A	C3
Doppel-Anschlagdichtung Joint de base double Double rebate gasket 	1	2	2A	C2
	2	2	2A	C2
	3	3	3A	C3
Senkdichtung Joint seuil Drop seal 	1	2	1A	C2
	2	2	2A	C2
	3	2	2A	C3
Auflaufdichtung Joint de contact Ramp seal 	1	2	0	C2
	2	2	0	C2
	3	2	0	C3

1 Fallenriegel-Schloss
 Serrure à mortaiser
 Latch and bolt lock





2 Schloss mit Obenverriegelung
 Serrure avec verrouillage supérieur
 Lock with top locking point

3 Mehrfachverriegelungs-Schloss
 Serrure à verrouillage multiple
 Multipoint lock

Zweiflügelige Türen,
 einwärts öffnend,
 Flügelhöhe ≤ 2200 mm

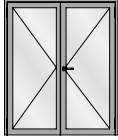
Porte à deux vantaux,
 ouvrant vers l'intérieur,
 hauteur du vantail ≤ 2200 mm

Double leaf door,
 inward opening,
 leaf height ≤ 2200 mm

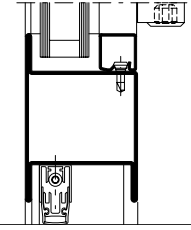
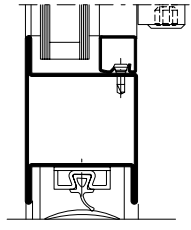
Variante		Beschlag Ferrure Fitting	 EN 12207	 EN 12208	 EN 12210
Senkdichtung Joint seuil Drop seal		❶	2	0	C2
		❷	2	0	C2
		❸	2	0	C3
Auflaufdichtung Joint de contact Ramp seal		❶	2	0	C2
		❷	2	0	C2
		❸	2	0	C3

❶ Fallenriegel-Schloss
 Serrure à mortaiser
 Latch and bolt lock



❷ Schloss mit Obenverriegelung
 Serrure avec verrouillage supérieur
 Lock with top locking point

❸ Mehrfachverriegelungs-Schloss
 Serrure à verrouillage multiple
 Multipoint lock

Zweiflügelige Türen,
 auswärts öffnend,
 Flügelhöhe ≤ 3000 mm

Porte à deux vantaux,
 ouvrant vers l'extérieur,
 hauteur du vantail ≤ 3000 mm

Double leaf door,
 outward opening,
 leaf height ≤ 3000 mm

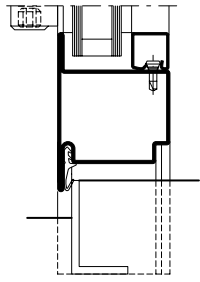
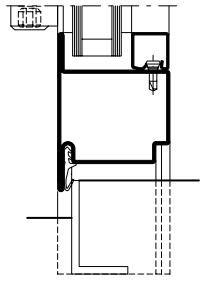
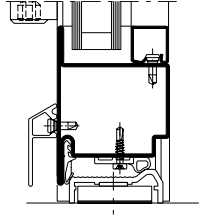
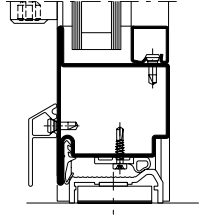
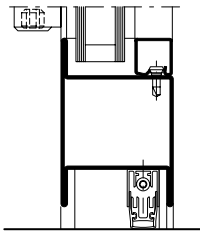
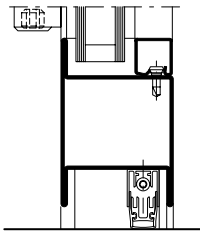
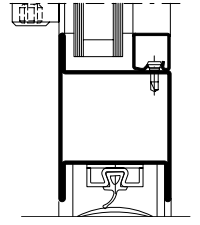
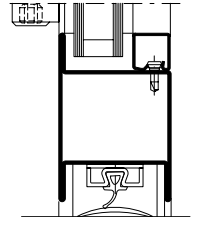
Variante	Beschlag Ferrure Fitting	 EN 12207	 EN 12208	 EN 12210		
Anschlagdichtung Joint de butée Rebate gasket 	Beschlag Ferrure Fitting 	1	0	0	C1	
		2	0	0	0	C1
		3	1	0	0	C2
Doppel-Anschlagdichtung Joint de base double Double rebate gasket 	Beschlag Ferrure Fitting 	1	1	0	C1	
		2	1	0	0	C1
		3	2	0	0	C2
Senkdichtung Joint seuil Drop seal 	Beschlag Ferrure Fitting 	1	0	0	C1	
		2	0	0	0	C1
		3	1	0	0	C2
Aufaufdichtung Joint de contact Ramp seal 	Beschlag Ferrure Fitting 	1	0	0	C1	
		2	0	0	0	C1
		3	1	0	0	C2

1 Fallenriegel-Schloss
 Serrure à mortaiser
 Latch and bolt lock





2 Schloss mit Obenverriegelung
 Serrure avec verrouillage supérieur
 Lock with top locking point

3 Mehrfachverriegelungs-Schloss
 Serrure à verrouillage multiple
 Multipoint lock

Zweiflügelige Türen,
 einwärts öffnend,
 Flügelhöhe ≤ 3000 mm

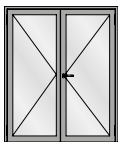
Porte à deux vantaux,
 ouvrant vers l'intérieur,
 hauteur du vantail ≤ 3000 mm

Double leaf door,
 inward opening,
 leaf height ≤ 3000 mm

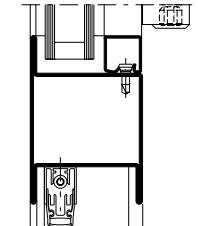
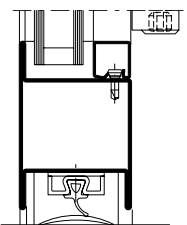
Variante		Beschlag Ferrure Fitting	 EN 12207	 EN 12208	 EN 12210
Senkdichtung Joint seuil Drop seal		1	0	0	C1
		2	0	0	C1
		3	1	0	C2
Auflaufdichtung Joint de contact Ramp seal		1	0	0	C1
		2	0	0	C1
		3	1	0	C2

U_f-Werte
(nach EN ISO 10077-2:2018-01)

Valeurs U_f
(selon EN ISO 10077-2:2018-01)

U_f values
(according to
EN ISO 10077-2:2018-01)

Auf den folgenden Seiten
finden Sie die U_f-Werte für die
verschiedenen Anwendungen von
Jansen-Economy 60 RS.

Vous trouverez les valeurs U_f
pour les différentes applications
Jansen-Economy 60 RS. dans les
pages qui suivent.

On the following pages you
will find the U_f values for the
various applications for
Jansen-Economy 60 RS.

Sie basieren auf folgenden
Grundlagen:

Elles se basent sur les principes
suivants:

They are based on the following:

Stahl

- Profile bandverzinkter Stahl,
unbeschichtet
- Stahl-Glasleisten
- Trockenverglasung
- Nassverglasung

Acier

- Profilés en bande d'acier zingué,
sans revêtement
- Parcloses en acier
- Vitrage à sec
- Vitrage à mastic



Steel

- Strip galvanised steel profiles,
uncoated
- Steel glazing beads
- Glazing with dry glazing
- Glazing with sealing

U_f-Werte
 (nach EN ISO 10077-2:2018-01)

Valeurs U_f
 (selon EN ISO 10077-2:2018-01)

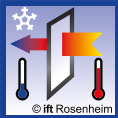
U_f values
 (according to EN ISO 10077-2:2018-01)

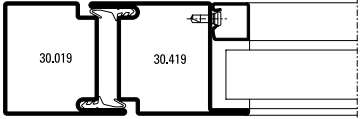
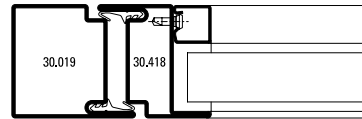
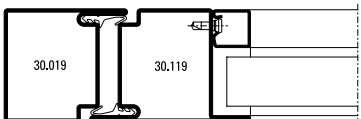
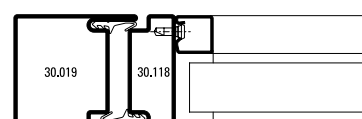
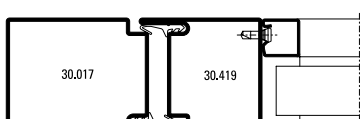
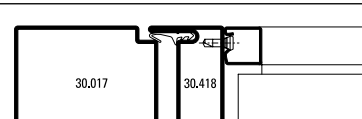
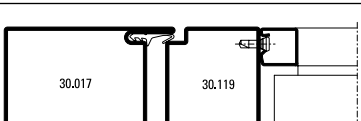
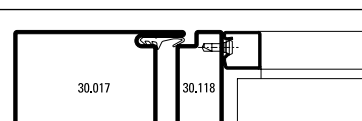
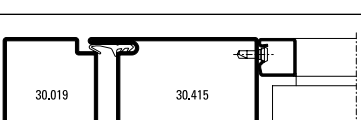
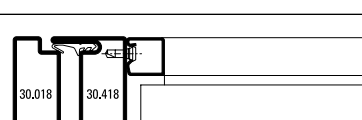
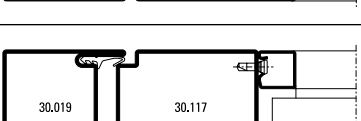
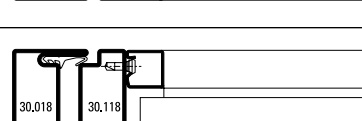
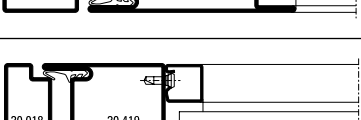
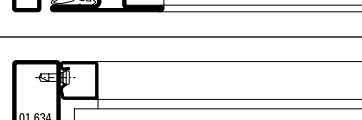
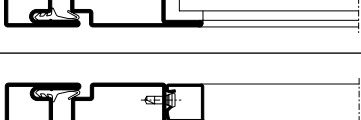
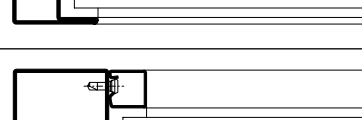
 Füllelementstärken Elements de remplissages Infill elements ≥ 24 mm		 Füllelementstärken Elements de remplissages Infill elements ≥ 24 mm	
	5,5 W/m ² K		5,7 W/m ² K
	5,6 W/m ² K		5,8 W/m ² K
	5,3 W/m ² K		5,5 W/m ² K
	5,3 W/m ² K		5,5 W/m ² K
	5,3 W/m ² K		6,0 W/m ² K
	5,3 W/m ² K		6,1 W/m ² K
	5,6 W/m ² K		6,9 W/m ² K
	5,7 W/m ² K		6,1 W/m ² K

U_f-Werte
 (nach EN ISO 10077-2:2018-01)

Valeurs U_f
 (selon EN ISO 10077-2:2018-01)

U_f values
 (according to EN ISO 10077-2:2018-01)

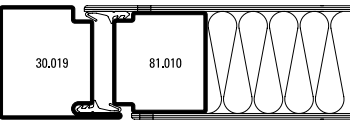
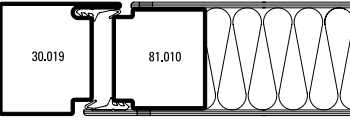
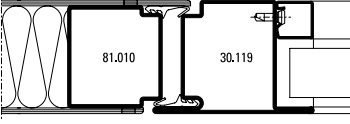
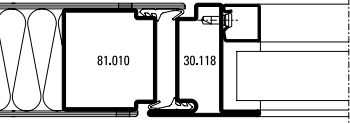
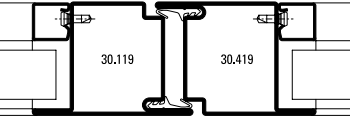
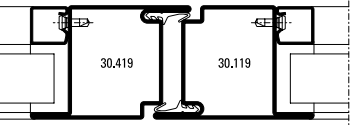
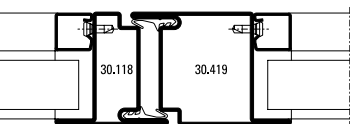
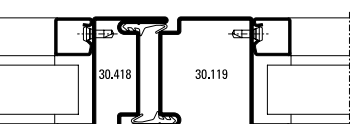

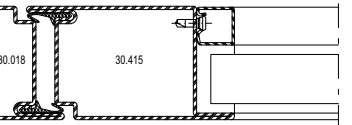
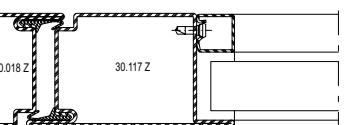
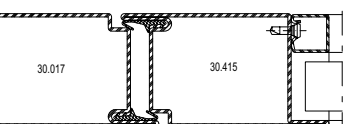
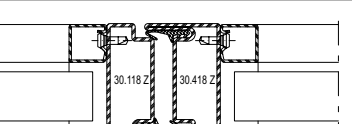
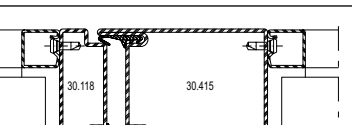
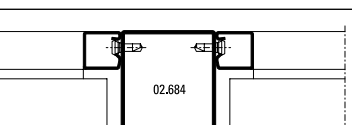
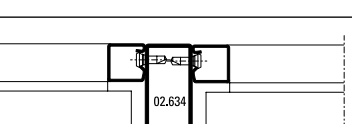
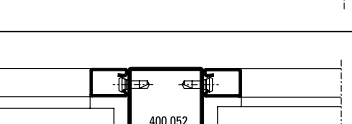
 Füllelementstärken Elements de remplissages Infill elements	≥ 24 mm
	5,3 W/m²K
	5,3 W/m²K
	5,7 W/m²K
	6,0 W/m²K
	5,8 W/m²K
	5,8 W/m²K
	6,1 W/m²K
	6,1 W/m²K

 Füllelementstärken Elements de remplissages Infill elements	≥ 24 mm
	5,3 W/m²K
	5,4 W/m²K
	5,1 W/m²K
	6,5 W/m²K
	5,7 W/m²K
	6,3 W/m²K
	7,2 W/m²K
	6,4 W/m²K

U_f-Werte
 (nach EN ISO 10077-2:2018-01)

Valeurs U_f
 (selon EN ISO 10077-2:2018-01)

U_f values
 (according to EN ISO 10077-2:2018-01)

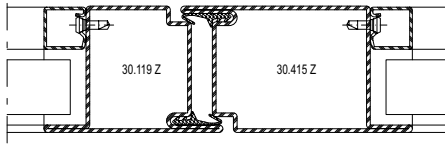
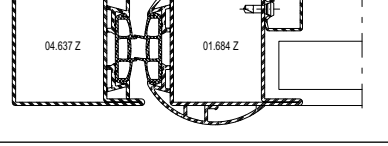
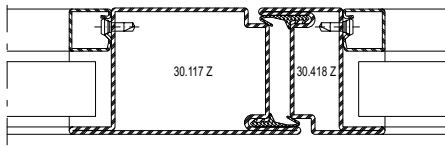
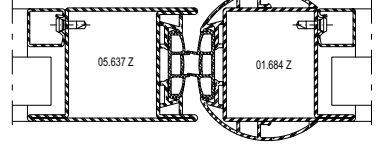
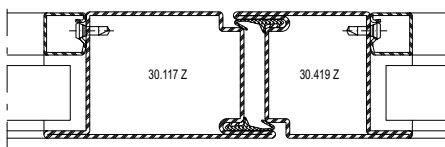
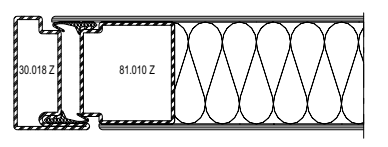
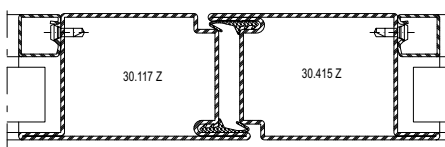
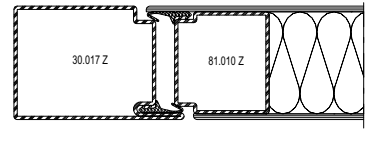
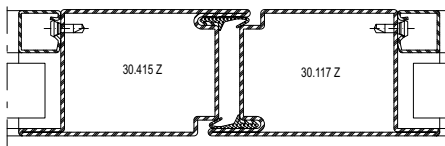
	Füllelementstärken Elements de remplissages Infill elements ≥ 24 mm		Füllelementstärken Elements de remplissages Infill elements ≥ 24 mm
	5,5 W/m²K		5,8 W/m²K
	5,7 W/m²K		6,0 W/m²K
	5,5 W/m²K		5,4 W/m²K
	5,3 W/m²K		5,1 W/m²K
	5,3 W/m²K		

U_f-Werte
 (nach EN ISO 10077-2:2018-01)

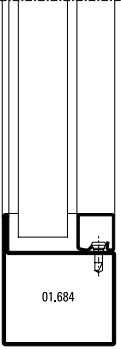
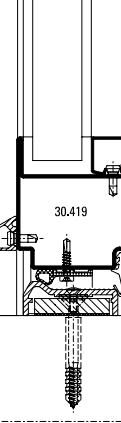
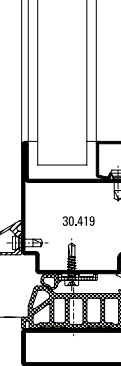
 Füllelementstärken Elements de remplissages Infill elements ≥ 24 mm	
	6,1 W/m ² K
	6,3 W/m ² K
	5,6 W/m ² K

Valeurs U_f
 (selon EN ISO 10077-2:2018-01)

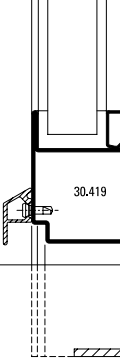
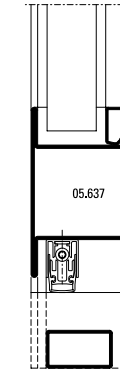
 Füllelementstärken Elements de remplissages Infill elements ≥ 24 mm	
	6,3 W/m ² K
	5,6 W/m ² K

U_f values
 (according to EN ISO 10077-2:2018-01)

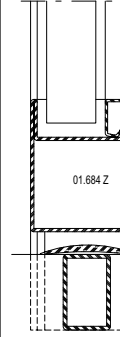
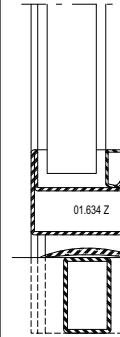
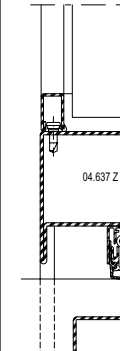
 Füllelementstärken Elements de remplissages Infill elements ≥ 24 mm	
	6,1 W/m ² K
	6,8 W/m ² K
	5,5 W/m ² K

U_f-Werte
 (nach EN ISO 10077-2:2018-01)

Valeurs U_f
 (selon EN ISO 10077-2:2018-01)

U_f values
 (according to EN ISO 10077-2:2018-01)

	Füllelementstärken Elements de remplissages Infill elements ≥ 24 mm
	5,6 W/m²K

	Füllelementstärken Elements de remplissages Infill elements ≥ 24 mm
	5,6 W/m²K

	Füllelementstärken Elements de remplissages Infill elements ≥ 24 mm
	5,7 W/m²K
	5,7 W/m²K

	4,4 W/m²K
--	------------------

	5,2 W/m²K
--	------------------



Schallschutz

Ausführungsvarianten

Die nachfolgende Typenübersicht ergibt einen Überblick über die beurteilten Varianten.

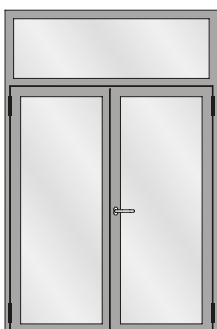
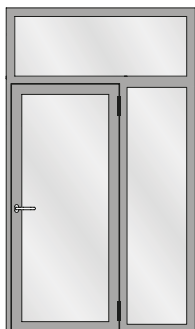
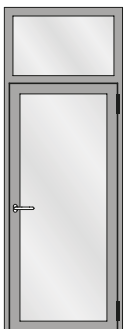
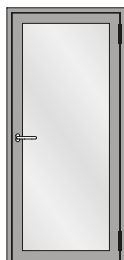

Isolation phonique

Modèles

L'aperçu des types suivant fournit une vue d'ensemble des variantes examinées.

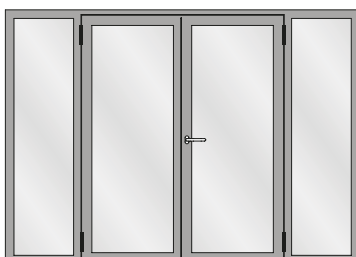
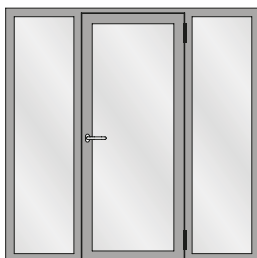
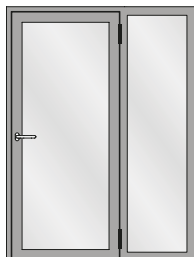
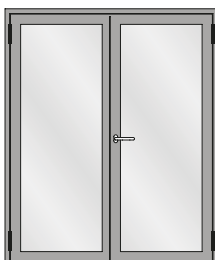

Sound insulation

Design range

The following overview of types provides an overview of the evaluated designs.

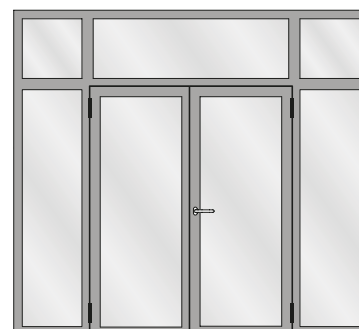
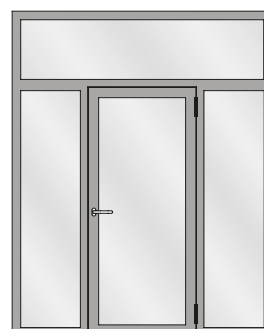

Schallschutz

Isolation phonique

Sound insulation

Tabelle A1

Korrekturtabelle für Jansen-Economy-Türen mit Glasfüllungen

Tableau A1

Tableau de correction pour les portes Jansen-Economy avec vitrage

Table A1

Correction table for Jansen-Economy doors with glass

	1	2	3	4	5	6	7	8	9	10	11
	Türe mit zwei absenkba- ren Bodendichtungen Porte avec deux joint seuil automatique Door with two threshold gaskets that can be lowered	Glas Verre Glass	Korrekturen Corrections Corrections								
	$R_{w(C, Ctr)}$ dB	$R_{w, P, Glas}$ dB	K_S dB	K_{FV} dB	K_{Nass} dB	K_{1aB} dB	$K_{W/S}$ dB	$K_{G 0,4}$ dB	$K_{G 1,8}$ dB	$K_{G 2,6}$ dB	$K_{G 3,2}$ dB
1	32 (-1; -5)	31	0	-1	0	0	0	0	-1	-2	-3
2	33 (-1; -5)	32	0	-1	0	0	0	0	-1	-2	-3
3	35 (-1; -5)	34	0	-1	0	0	0	0	-1	-2	-3
4	36 (-2; -5)	35	0	-1	-1	0	0	0	-1	-2	-3
5	37 (-2; -5)	37	0	0	-1	0	-1	0	-1	-2	-3
6	38 (-2; -5)	39	0	0	-1	-1	-1	0	-1	-2	-3
7	39 (-2; -5)	40	0	0	-1	-1	-1	0	-1	-2	-3
8	40 (-2; -5)	41	0	0	-1	-1	-2	-1	-1	-2	-3
9	41 (-2; -5)	42	0	0	-1	-1	-2	-2	-1	-2	-3
10	42 (-2; -5)	43	-1	0	-1	-1	-2	-2	-1	-2	-3
11	42 (-2; -5)	44	-1	0	-1	-1	-2	-2	-1	-2	-3
12	43 (-2; -5)	45	-1	+1	-1	-1	-3	-3	-1	-2	-3
13	44 (-2; -5)	49	-1	+1	-1	-2	-3	-3	-1	-2	-3

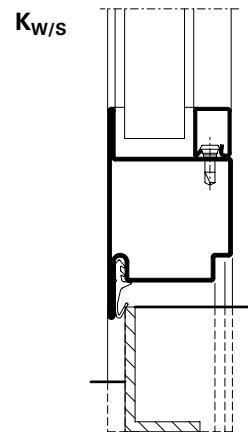
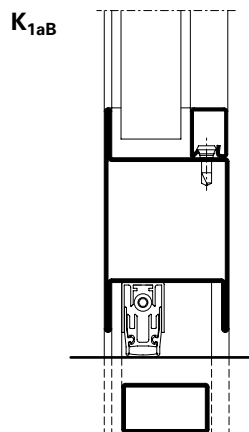
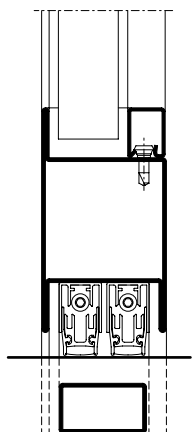

Schallschutz

Der aus der Tabelle A1 abzulesende Wert für die Schalldämmung $R_{w, Tür}$ beträgt:

Isolation phonique

La valeur à relever sur le tableau A1 concernant l'isolement contre les sons aériens $R_{w, Porte}$ est la suivante:

Sound insulation

The value taken from table A1 for the sound insulation $R_{w, Door}$ is:

$$R_{w, Tür} = R_w + K_S + K_{FV} + K_{Nass} + K_{1aB} + K_{W/S} + K_{Band} + K_{G 0,4} + K_{G 1,8} + K_{G 2,6} + K_{G 3,2} \text{ dB}$$

- R_w** bewertetes Schalldämm-Mass der Türe in Abhängigkeit von der Schalldämmung $R_{w,P, Glas}$
- $R_{w,P, Glas}$** bewertetes Schalldämm-Mass der Verglasung (Prüfwert nach ISO 140-3, mit Prüfnachweis einer PÜZ-Stelle). Alternativ können Tabellenwerte nach DIN EN 12758, Abschnitt 6 verwendet werden
- K_S** Korrekturwert für zweiflügelige Türen
- K_{FV}** Korrekturwert für Festverglasungen mit erhöhtem Scheibenanteil
- K_{Nass}** Korrekturwert für Nassverglasung
- K_{1aB}** Korrekturwert für Türen mit einer absenkbaren Bodendichtung
- K_{Band}** Korrekturwert bei Verwendung von Anschlagbändern, die eine Dichtungsebene unterbrechen ($K_{Band} = - 0,5 \text{ dB pro Band}$)
- $K_{W/S}$** Korrekturwert für Türen mit einer Anschlagsschwelle
- $K_{G 0,4}$** Korrekturwert für Einzelscheiben mit einer Glasfläche $\leq 0,4 \text{ m}^2$. Die Korrektur gilt auch für Konstruktionen mit glasteilenden Sprossen.
- $K_{G 1,8}$** Korrekturwert für Einzelscheiben mit einer Glasfläche $\geq 1,8 \text{ m}^2$
- $K_{G 2,6}$** Korrekturwert für Einzelscheiben mit einer Glasfläche $\geq 2,6 \text{ m}^2$
- $K_{G 3,2}$** Korrekturwert für Einzelscheiben mit einer Glasfläche $\geq 3,2 \text{ m}^2$

- R_w** Mesure d'isolement contre les sons aériens des portes évaluée suivant l'isolement phonique $R_{w,P, Glas}$
- $R_{w,P, Glas}$** Cote d'isolement acoustique du vitrage évalué (valeur contrôlée selon ISO 140-3 avec certificat d'un bureau de contrôle, de surveillance ou de certification). Il est également possible d'utiliser les valeurs selon le tableau DIN EN 12758, section 6
- K_S** Valeur de correction pour portes à deux vantaux
- K_{FV}** Valeur de correction pour vitrages fixes à fort pourcentage de vitre
- K_{Nass}** Valeur de correction pour vitrage avec mastic
- K_{1aB}** Valeur de correction pour portes avec un joint seuil automatique
- K_{Band}** Valeur corrective en cas d'utilisation de paumelles qui interrompent un plan d'étanchéité ($K_{Band} = - 0,5 \text{ dB par paumelle}$)
- $K_{W/S}$** Valeur de correction pour portes avec un seuil de butée
- $K_{G 0,4}$** Valeur de correction pour vitres individuelles avec une surface vitrée $\leq 0,4 \text{ m}^2$. La correction s'applique aussi aux constructions à meneaux séparant les vitres.
- $K_{G 1,8}$** Valeur de correction pour vitres individuelles avec surface vitrée $\geq 1,8 \text{ m}^2$
- $K_{G 2,6}$** Valeur de correction pour vitres individuelles avec surface vitrée $\geq 2,6 \text{ m}^2$
- $K_{G 3,2}$** Valeur de correction pour vitres individuelles avec surface vitrée $\geq 3,2 \text{ m}^2$

- R_w** Airborne sound reduction index of doors depending on the sound insulation $R_{w,P, Glas}$
- $R_{w,P, Glas}$** Airborne sound reduction index (test value in accordance with ISO 140-3, with a test certificate from a recognised testing, inspection or certification body). Alternatively, the tabulated values in DIN EN 12758, Section 6 may be used
- K_S** Correction value for double-leaf doors
- K_{FV}** Correction value for fixed glazing with increased proportion of pane
- K_{Nass}** Correction value for glazing with sealing
- K_{1aB}** Correction value for doors with a threshold gasket that can be lowered
- K_{Band}** Correction value when using hinges that interrupt a sealing plane ($K_{Band} = - 0.5 \text{ dB per hinge}$)
- $K_{W/S}$** Correction value for doors with a rebate threshold
- $K_{G 0,4}$** Correction value for single panes with a glass area $\leq 0,4 \text{ m}^2$. The correction also applies to buildings with glazing bars
- $K_{G 1,8}$** Correction value for single panes with a glass area $\geq 1,8 \text{ m}^2$
- $K_{G 2,6}$** Correction value for single panes with a glass area $\geq 2,6 \text{ m}^2$
- $K_{G 3,2}$** Correction value for single panes with a glass area $\geq 3,2 \text{ m}^2$

METALFORM

METALFORM

MASTERS OF METAL

UNITED KINGDOM

METALFORM

NORWAYMETAL LTD

53 Chelsea Manor Street

London, SW3 5RZ

SALES@METALFORM.UK

+44 20 81298814

GERMANY

METALFORM GMBH

Carl-Zeiss-Ring 15A

85737 Ismaning

SALES@METALFORMGROUP.DE

+49 17663630406

NORWAY

METALFORM AS

Brochmannsveien 2

1950 Rømskog

SALG@METALFORM.NO

+47 401 62 446

METALFORMGROUP

SALES@METALFORMGROUP.COM